

FM Stereo FM-AM Receiver

Operating Instructions

*STR-DE505
STR-DE405
STR-D450Z
STR-D350Z*

WARNING

To prevent fire or shock hazard, do not expose the unit to rain or moisture.



This symbol is intended to alert the user to the presence of uninsulated "dangerous voltage" within the product's enclosure that may be of sufficient magnitude to constitute a risk of electric shock to persons.



This symbol is intended to alert the user to the presence of important operating and maintenance (servicing) instructions in the literature accompanying the appliance.

IMPORTANT

This equipment has been tested and found to comply with the limits for a Class B digital device, pursuant to Part 15 of the FCC Rules.

These limits are designed to provide reasonable protection against harmful interference in a residential installation. This equipment generates, uses, and can radiate radio frequency energy and, if not installed and used in accordance with the instructions, may cause harmful interference to radio communications. However, there is no guarantee that interference will not occur in a particular installation. If this equipment does cause harmful interference to radio or television reception, which can be determined by turning the equipment off and on, the user is encouraged to try to correct the interference by one or more of the following measures:

- Reorient or relocate the receiving antenna.
- Increase the separation between the equipment and receiver.
- Connect the equipment into an outlet on a circuit different from that to which the receiver is connected.
- Consult the dealer or an experienced radio/TV technician for help.

CAUTION

You are cautioned that any change or modifications not expressly approved in this manual could void your authority to operate this equipment.

Note to CATV system installer

This reminder is provided to call the CATV system installer's attention to Article 820-40 of the NEC that provides guidelines for proper grounding and, in particular, specifies that the cable ground shall be connected to the grounding system of the building, as close to the point of cable entry as practical.

Owner's record

The model and serial numbers are located on the rear of the unit. Record the serial number in the space provided below. Refer to them whenever you call upon your Sony dealer regarding this product.

Model No. STR-DE505/STR-DE405/
STR-D450Z/STR-D350Z

Serial No. _____

Precautions

On safety

- Should any solid object or liquid fall into the cabinet, unplug the receiver and have it checked by qualified personnel before operating it any further.

On power sources

- Before operating the receiver, check that the operating voltage is identical with your local power supply. The operating voltage is indicated on the nameplate at the rear of the receiver.
- The receiver is not disconnected from the AC power source (MAINS) as long as it is connected to the wall outlet, even if the receiver itself has been turned off.
- If you are not going to use the receiver for a long time, be sure to disconnect the receiver from the wall outlet. To disconnect the AC power cord, grasp the plug itself; never pull the cord.
- One blade of the plug is wider than the other for the purpose of safety and will fit into the wall outlet only one way. If you are unable to insert the plug fully into the outlet, contact your dealer.
- Should the AC power cord need to be changed, have it done at a qualified service shop only.

On placement

- Place the receiver in a location with adequate ventilation to prevent heat build-up and prolong the life of the receiver.
- Do not place the receiver near heat sources, or in a place subject to direct sunlight, excessive dust or mechanical shock.
- Do not place anything on top of the cabinet that might block the ventilation holes and cause malfunctions.

On operation

- Before connecting other components, be sure to turn off and unplug the receiver.

On cleaning

- Clean the cabinet, panel and controls with a soft cloth slightly moistened with a mild detergent solution. Do not use any type of abrasive pad, scouring powder or solvent such as alcohol or benzene.

For detailed safety precautions, see the "IMPORTANT SAFEGUARDS" leaflet.

If you have any question or problem concerning your receiver, please consult your nearest Sony dealer.

About This Manual

The instructions in this manual are for models STR-DE505, STR-DE405, STR-D450Z and STR-D350Z. Check your model number by looking at the upper right corner of the front panel or lower right corner of the remote. In this manual, the STR-DE505 is the model used for illustration purposes, any difference in operation is clearly indicated in the text, for example, "STR-DE505 only".

Type of differences

Model	DE505	DE405 /D450Z /D350Z
Feature		
MIX AUDIO OUT	•	

Conventions

The instructions in this manual describe the controls on the receiver. You can also use the controls on the remote if they have the same or similar names as those on the receiver.

- A "Quick Reference Guide" is supplied on page 23.
- The "Remote Button Descriptions" section on page 22 provides an overview of the remote buttons.
- The following icons are used in this manual:



Indicates that you can use only the remote to do the task.



Indicates hints and tips for making the task easier.

This receiver has the Dolby Surround system.

Manufactured under license from Dolby Laboratories Licensing Corporation. Additionally licensed under Canadian patent number 1,037,877. "Dolby," the double-D symbol  and "Pro Logic" are trademarks of Dolby Laboratories Licensing Corporation.

TABLE OF CONTENTS

Getting Started

- Unpacking 4
- Hookup Overview 4
- Antenna Hookups 5
- Audio Component Hookups 5
- Speaker System Hookups 6
- Video Component Hookups 7
- AC Hookups 8
- Before You Use Your Receiver 8

Receiver Operations

- Selecting a Component 8
- Receiving Broadcasts 11
- Presetting Radio Stations 12
- Recording 13
- Choosing a Surround Mode 14
- Getting the Most Out of Dolby Pro Logic Surround Sound 15

Additional Information

- Troubleshooting 17
- Specifications 18
- Glossary 19

Index 20

Rear Panel Descriptions 21

Remote Button Descriptions 22

Quick Reference Guide 23

Unpacking

Check that you received the following items with the receiver:

- FM wire antenna (1)
- AM loop antenna (1)
- Remote controller (remote) (1)
- Size AA (R6) batteries (2)

Inserting batteries into the remote

Insert two size AA (R6) batteries in accordance with the + and - markings on the battery compartment.

When using the remote, point it at the remote sensor  on the receiver.

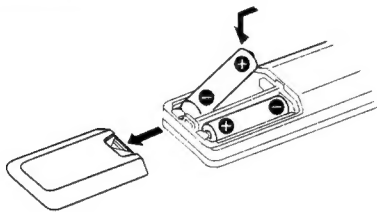

When to replace batteries

Under normal use, the batteries should last for about 6 months. When the remote no longer operates the receiver, replace both batteries with new ones.

Notes

- Do not leave the remote in an extremely hot or humid place.
- Do not use a new battery with an old one.
- Do not expose the remote sensor to direct sunlight or lighting apparatuses. Doing so may cause a malfunction.
- If you don't use the remote for an extended period of time, remove the batteries to avoid possible damage from battery leakage and corrosion.

Hookup Overview

The receiver allows you to connect and control the following audio/video components. Follow the hookup procedures for the components that you want to connect to the receiver on the pages specified. To learn the locations and names of each jack, see "Rear Panel Descriptions" on page 21.

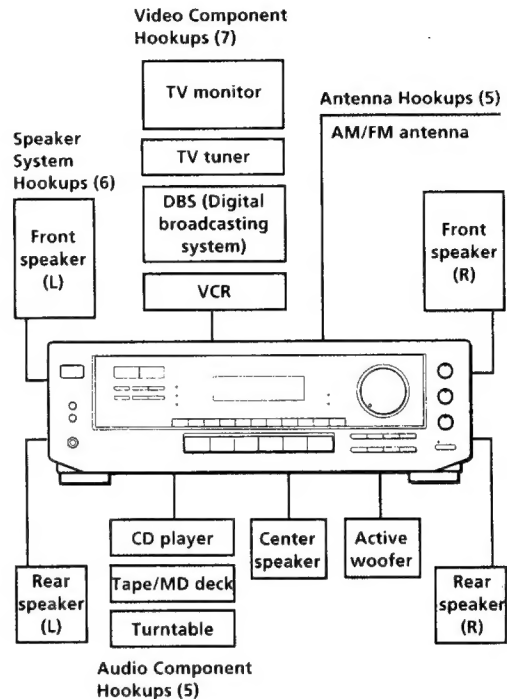

Before you get started

- Turn off the power to all components before making any connections.
- Do not connect the AC power cords until all of the connections are completed.
- Be sure to make connections firmly to avoid hum and noise.
- When connecting an audio/video cable, be sure to match the color-coded pins to the appropriate jacks on the components: Yellow (video) to Yellow; White (left, audio) to White; and Red (right, audio) to Red.

Antenna Hookups

Overview

This section describes how to connect AM and FM antennas to the receiver. If you want to receive radio broadcasts with the receiver, complete these connections first, then go to the following pages. For specific locations of the terminals, see the illustration below.

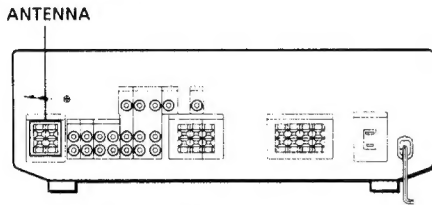

What antennas will I need?

- FM wire antenna (supplied) (1)
- AM loop antenna (supplied) (1)

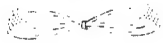

Hookups

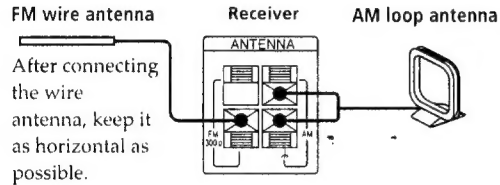

💡 If you have poor FM reception

Connect a 75-ohm coaxial cable (not supplied) to an FM outdoor antenna. Pull back the mesh portion surrounding the inner cable and connect it to the earth terminal (right side). Connect the inner cable to the FM terminal (left side).

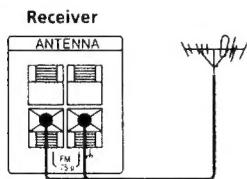

💡 If you have poor AM reception

Connect a 20 to 50 ft. (6 to 15-meter) insulated wire (not supplied) to the AM antenna terminal in addition to the AM loop antenna. Try to extend the wire outdoors and keep it horizontal.

Connecting a ground wire

To prevent hum, connect a ground wire (not supplied) to the $\#$ ground terminal. If you've connected an outdoor antenna, be sure to connect the ground for lightning protection.

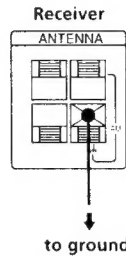

Where do I go next?

If you want to connect other components, go on to the next section. If you're only planning to use the receiver to listen to the radio, go to "Speaker System Hookups" on pages 6 and 7.

Audio Component Hookups

Overview

This section describes how to connect your audio components to the receiver. If you want to use the receiver as an amplifier, complete these connections. For specific locations of the jacks, see the illustration below.

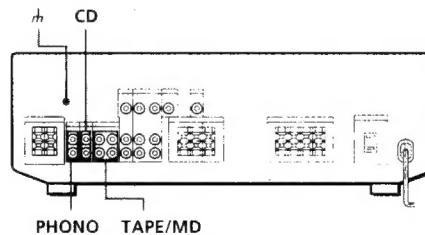

What cords will I need?

Audio cords (not supplied) (1 for each CD player or turntable; 2 for each tape deck or MD recorder)

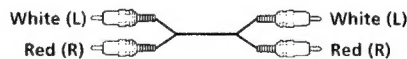

(continued)

Hookups

The arrow → indicates signal flow.

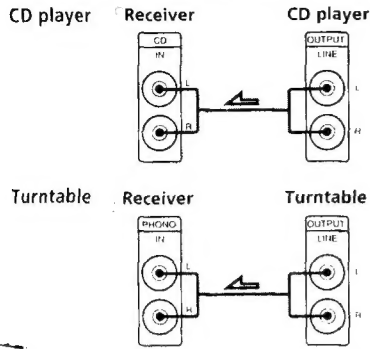

- If your turntable has an earth lead
To prevent hum, connect the earth lead to the \oplus ground terminal on the receiver.

Tape deck or MD recorder

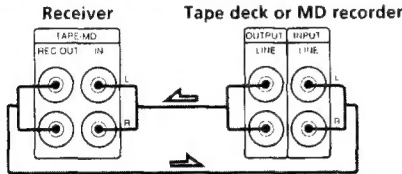

Where do I go next?

Go on to the next section to connect the speakers.

Speaker System Hookups

Overview

This section describes how to connect your speakers to the receiver. Although front (left and right) speakers are required, center and rear speakers are optional. Adding center and rear speakers will enhance the surround effects. Connecting an active woofer will increase bass response (for STR-DE505 only). For specific locations of the terminals, see the illustration below.

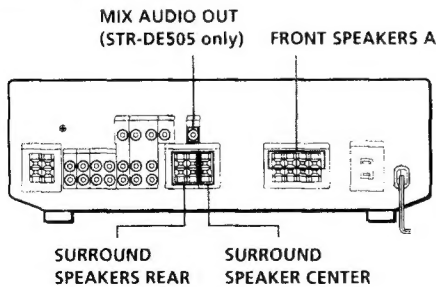

For optimum surround sound effect, place your speakers as shown below.

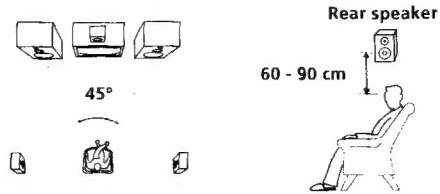

What cords will I need?

Speaker cord (not supplied) (1 for each speaker)



Twist the stripped ends of the cord about 2/3 inch (15 mm). Be sure to match the speaker cord to the appropriate terminal on the components: + to + and - to -. If the cords are reversed, the sound will be distorted and will lack bass.

Hookups

Front speakers

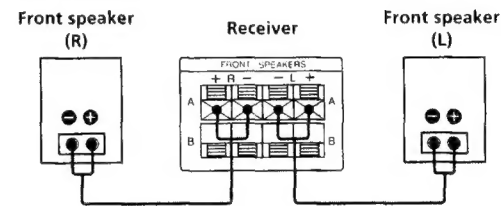

Rear and center speakers

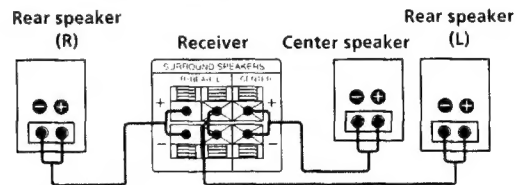

Note

Be sure to connect the both rear speakers (L and R). No sound is heard if only one speaker is connected.

Active woofer (STR-DE505 only)

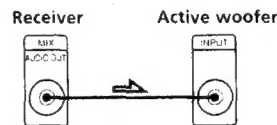

- 💡 If you have an additional front speaker system
Connect them to the FRONT SPEAKERS B terminals.

- 💡 If your TV monitor uses separate speakers
You can connect one of them to the SURROUND SPEAKER CENTER terminals for use with Dolby Pro Logic Surround sound (see page 15).

Selecting the speaker system

To drive the speakers, select the speaker system as follows:

To drive	Depress SPEAKERS button
Speaker system A (connected to the FRONT SPEAKERS A terminals)	A
Speaker system B (connected to the FRONT SPEAKERS B terminals)	B
Both speaker systems A and B (series connection)	A+B

Notes

- If you want to enjoy the surround sound, be sure to connect the front speakers to the FRONT SPEAKERS A terminal.
- No sound is heard when you press SPEAKERS A+B without connecting speaker system B.

Where do I go next?

To complete your system, go to "AC Hookups" on page 8. If you want to connect video components to enjoy surround sound when watching/listening to TV programs or video tapes, go on to the next section.

Video Component Hookups

Overview

This section describes how to connect video components to the receiver. For specific locations of the jacks, see the illustration below.

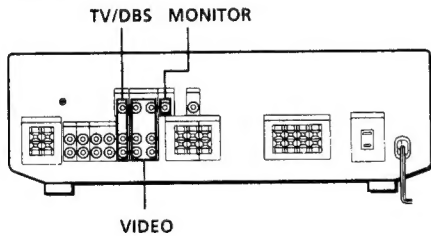

What cables will I need?

- Audio/video cable (not supplied) (1 for each TV tuner or Digital broadcasting system; 2 for the VCR)

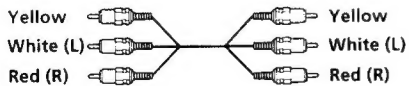

- Video cable (not supplied) (1 for a TV monitor)



Hookups

The arrow \Rightarrow indicates signal flow.

TV/DBS

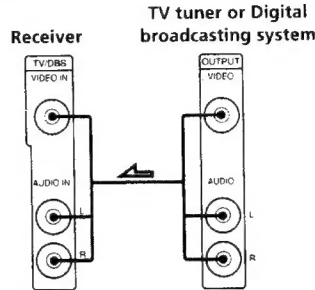

MONITOR

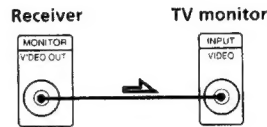

VCR

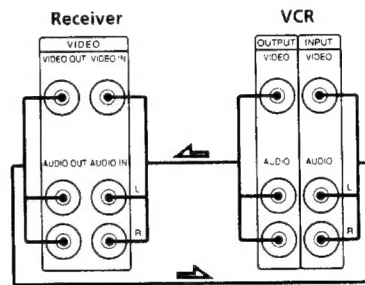

Where do I go next?

Go on to the next section to connect the AC power cord and complete your home theater system.

AC Hookups

Connecting the AC power cord

Connect the AC power cord from this receiver and from your audio/video components to a wall outlet. If you connect other audio components to the SWITCHED AC OUTLET on the receiver, the receiver can supply power to the connected components so you can turn on/off the whole system when you turn on/off the receiver.

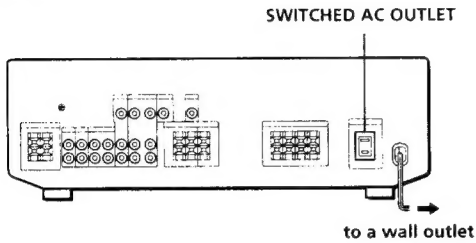

Caution

Make sure that the power consumption of the component connected to the receiver's AC outlet does not exceed 120 watts. Do not connect high-wattage electrical home appliances such as electric irons, fans, or TVs to this outlet.

Where do I go next?

Before you use the receiver, go to the next section to make sure that all the controls are set to the appropriate positions.

Before You Use Your Receiver

Before you start using your receiver, make sure that you have:

- Turned MASTER VOLUME to the leftmost position (0).
- Selected the appropriate speaker system. (See "Selecting the speaker system" on page 7.)
- Set BALANCE to the center position.

Turn on the receiver and check the following display.

- Press MUTING on the remote if "MUTING" is displayed.

Selecting a Component

To listen to or watch a connected component, first select the function on the receiver or with the remote. Before you begin, make sure you have:

- Connected all components securely and correctly as indicated on pages 5 to 8.
- Turned MASTER VOLUME to the leftmost position (0) to avoid damaging your speakers.

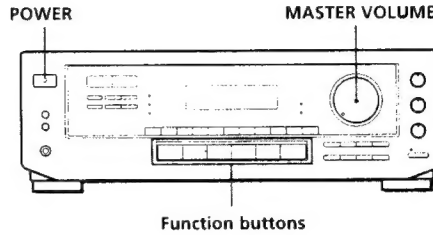

- 1** Press POWER to turn on the receiver.
- 2** Press a function button to select the component you want to use:

To listen to or watch	Press
Records	PHONO
Radio programs	TUNER
Compact discs (CD)	CD
Audio tapes or MiniDiscs (MD)	TAPE/MD
TV programs or Digital broadcasting system	TV/DBS
Video tapes	VIDEO

- 3** Turn on the component, for example, a CD player, and then start playing.
To tune in radio stations on this receiver, see "Receiving Broadcasts" on page 11.
- 4** Turn MASTER VOLUME to adjust the volume.
To adjust the volume of the TV's speakers, use the volume control on the TV.

To	Do this
Mute the sound	Press MUTING on the remote. Press again to restore the sound.
Reinforce the bass	Press BASS BOOST to turn on the BASS BOOST indicator.
Adjust the balance	Turn the BALANCE control left or right.
Adjust the tone quality	Adjust the BASS and TREBLE controls.

💡 When you listen with headphones

Connect the headphones to the **PHONES** jack and set the **SPEAKERS** buttons to **OFF**.

Watching/listening to video programs

When you watch/listening to TV or video programs, we recommend you play audio portion through the receiver instead of your TV's speaker. This lets you take advantage of the receiver's surround sound effects, like Dolby Pro Logic Surround and lets you use the receiver's remote to control the audio. Turn off the speakers on your TV before you start so you can enjoy the surround sound from your receiver.

To watch/listening to TV programs, turn on the TV, TV tuner and the receiver and press **TV/DBS** on the receiver.

To watch videos, do the following:

- 1 Press **VIDEO** to select the VCR.
- 2 Turn on the TV and set the TV's video input to match your video component.
- 3 Turn on the VCR, and start playback.

Using the remote

The remote lets you operate the receiver and the Sony components that are connected to it.

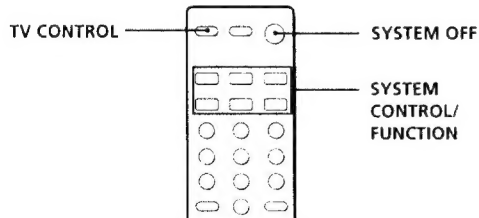

- 1 Press one of the **SYSTEM CONTROL/FUNCTION** buttons to select the component you want to use. The **SYSTEM CONTROL/FUNCTION** buttons on the remote are factory-set as follows:

To listen to	Press
Records	PHONO
Radio programs	TUNER
Compact discs (CD)	CD
Audio tapes or MiniDiscs (MD)	TAPE/MD
TV programs	TV
VHS Video tapes (VTR-3 mode)	VIDEO

If you want to change the factory setting of a button, see page 10.

The receiver and the selected component turn on.

If the component does not turn on

Press the power switch on the component.

- 2 Start playing. Refer to "Remote Button Descriptions" on page 22 for details.

To turn off the components

Press **SYSTEM OFF**. You can turn off the video and audio components connected to the **SWITCHED AC OUTLET** at the same time.

💡 If you use a Sony TV

When you press **TV** to watch a TV program, the TV turns on and switches to the TV input. The TV also turns on when you press **VIDEO** and switches to the appropriate video input.

If the TV does not switch to the appropriate input automatically, press **TV/VIDEO**.

💡 When you watch TV without using the receiver (only for Sony TVs)

Press **TV CONTROL** to set the remote to operate only the TV. When you press this button, the TV turns on and switches to the TV input. If the TV does not switch to the TV input automatically, press **TV/VIDEO**.

Operating one component while using another (Background Operation)

You can temporarily operate other components while listening to or watching a program.

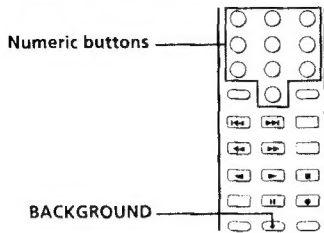

- 1 Hold down BACKGROUND.
- 2 Press both the corresponding numeric button of the component you're going to use (see the table below) and one of the following buttons at the same time; VISUAL POWER, TV/VIDEO, CH PRESET +/-, ANT TV/VTR, D.SKIP, ►, ◄, ■, ◀▶, ◀▶▶, ||, ●.

Example: To start recording on a tape deck while listening to a CD
While holding down BACKGROUND, press 4 (or 5) and press ● at the same time.

The numeric buttons are assigned to select the functions as follows:

Numeric button	Operates
1	CD player
2	DAT deck
3	MD deck
4	Tape deck A
5	Tape deck B
6	LD player
7	VCR (remote control mode VTR 1*)
8	VCR (remote control mode VTR 2*)
9	VCR (remote control mode VTR 3*)
0	TV

* Sony VCRs are operated with a VTR 1, 2 or 3 setting. These correspond to Beta, 8mm and VHS respectively.

Changing the factory setting of a function button

If the factory settings of the FUNCTION buttons (page 9) don't match your system components, you can change them. For example, if you have two CD players and you don't have a tape deck or an MD recorder, you can assign the TAPE/MD button to your second CD player.

Note that the settings of the TUNER and PHONO buttons cannot be changed.

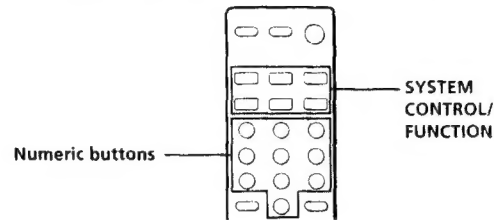

- 1 Hold down the SYSTEM CONTROL/FUNCTION button whose function you want to change (TAPE/MD, for example).
- 2 Press the corresponding numeric button of the component you want to assign to the SYSTEM CONTROL/FUNCTION button (1 - CD player, for example).

For the numeric buttons, see the table in "Operating one component while using another" on this page.

Now you can use the TAPE/MD button to control a second CD player.

To reset the setting to the factory setting

Repeat the above procedure.

Receiving Broadcasts

This receiver lets you enter a station's frequency directly by using the numeric buttons (direct tuning). If you don't know the frequency of the station you want, see "Receiving broadcasts by scanning stations (automatic tuning)" on this page.

Before you begin, make sure you have:

- Connected an FM/AM antenna to the receiver as indicated on page 5.
- Selected the appropriate speaker system. (See "Selecting the speaker system" on page 7.)

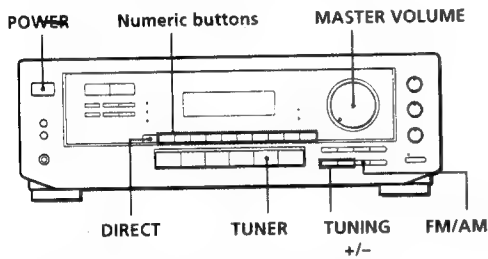

- 1 Press POWER to turn on the receiver.
- 2 Press TUNER.
The last received station is tuned in.
- 3 Press FM/AM to select FM or AM stations.
- 4 Press DIRECT.
- 5 Press the numeric buttons to enter the frequency.

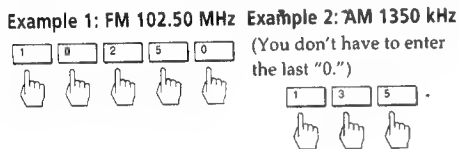

- 6 When you tune in AM stations, adjust the direction of the AM loop antenna for optimum reception.

To receive other stations

Repeat Steps 3 to 5.

If the STEREO indicator remains off

Press FM MODE when an FM stereo broadcast is received.

If an FM stereo program is distorted

The STEREO indicator flashes. Press FM MODE to change to monaural (MONO). You will not have the stereo effect but the distortion will be reduced. To return to stereo mode, press this button again.

If you cannot tune in a station and the entered numbers are flashing

Make sure you've entered the right frequency. If not, press DIRECT and re-enter the frequency you want. If the entered numbers still flash, the frequency is not used in your area.

To watch FM simulcast TV programs

Make sure that you tune in the simulcast program both on the TV (or the VCR) and on the receiver.

If you enter a frequency not covered by the tuning interval

The entered value is automatically rounded up or down to the closest covered value.

Tuning intervals for direct tuning are:

FM: 50 kHz intervals

AM: 10 kHz intervals (to change to 9 kHz intervals, see page 18)

Receiving broadcasts by scanning stations (automatic tuning)

If you don't know the frequency of the radio station you want, you can have the receiver scan all the receivable stations to locate the one you want.

- 1 Press TUNER.
The last received station is tuned in.
- 2 Press FM/AM to select FM or AM.
- 3 Press TUNING + or -.
Press the + button for a higher station number; press the - button for a lower one. When you tune past either end of the band, the receiver automatically jumps to the opposite end. Every time a station is received, the receiver stops scanning. To continue scanning, press the button again.

Presetting Radio Stations

You'll most likely want to preset the receiver with the radio stations you listen to often so that you don't have to tune in the station every time. The receiver can store a total of 30 FM or AM stations. You can store the stations on preset numbers combining 3 characters (A, B, C) and numbers (0 - 9). For example, you can store a station as preset number A1, B6 or C9, etc.

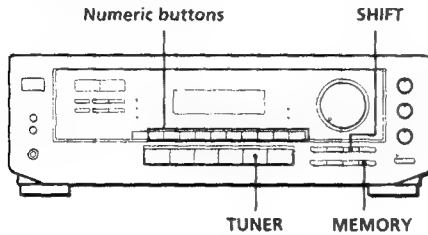

- 1 Press TUNER.
The last received station is tuned in.
- 2 Tune in the station you want.
If you are not familiar with how to tune in a station, see "Receiving Broadcasts" on the previous page.
- 3 Press MEMORY.
"MEMORY" appears for a few seconds.
Do steps 4 and 5 before "MEMORY" goes out.
- 4 Press SHIFT to select a character (A, B or C).
Each time you press SHIFT, the letter "A," "B" or "C" appears in the display.
If "MEMORY" disappears, start again from step 3.
- 5 While MEMORY is displayed, press the number you want to use (0 to 9).
- 6 Repeat Steps 2 to 5 to preset other stations.

To change a preset station

Preset a new station on the number you want to change.

Note

If the AC power cord is disconnected for about one week, the preset stations will be cleared from the receiver's memory, and you will have to preset the stations again.

Tuning preset stations (preset tuning)

You can tune directly to a preset station by entering its preset number. If you don't know which stations are preset on which numbers, you can tune by scanning the preset stations.

- 1 Press TUNER.
The last received station is tuned in.
- 2 Press SHIFT to select a character (A, B or C), then press the number.
For example, select A and then press 7 to tune in the station preset as A7.



You can tune by scanning the preset stations

First press TUNER and then press PRESET TUNING + or - to select the station you want. Each time you press the buttons, the preset numbers change as follows:

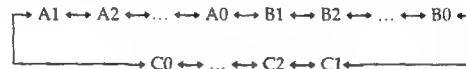

Recording

This receiver makes it easy to record to and from the components connected to the receiver. You don't have to connect playback and recording components directly: once you select a program source on the receiver, you can record and edit as you normally would using the controls on each component. Before you begin, make sure you've connected all components properly.

Function buttons

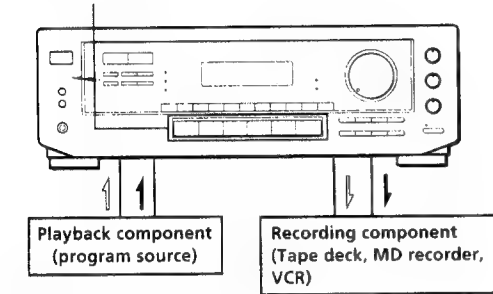

⇌: Audio signal flow
 →: Video signal flow

Recording on an audio tape or MiniDisc

You can record on a cassette tape or MiniDisc using the receiver. See the instruction manual of your tape deck or MD recorder if you need help.

- 1 Press one of the function buttons to select the program source.
- 2 Set the component to be ready for playing. For example, insert a CD into the CD player.
- 3 Insert a blank tape or disc into the recording deck and adjust the recording level, if necessary.
- 4 Start recording on the recording deck and then start playing the component.

Recording on a video tape

You can record TV program or digital broadcasting system using the receiver. You can also add audio from a variety of audio sources when editing a video tape. See your VCR's instruction manual if you need help.

- 1 Press TV/DBS to select the program source.
- 2 Set the component to be ready for playing. For example, turn on the TV and TV tuner.
- 3 Insert a blank video tape into the VCR for recording.
- 4 Start recording on the VCR.



You can replace audio while editing a video tape

At the point you want to start adding different sound, press another function button (for example, CD) and start playback. The sound from the selected component will be recorded over the original audio.

To resume recording the original sound, press the TV/DBS function button.

Choosing a Surround Mode

You can take advantage of surround sound simply by selecting one of the three pre-programmed surround modes according to the type of music you wish to play.

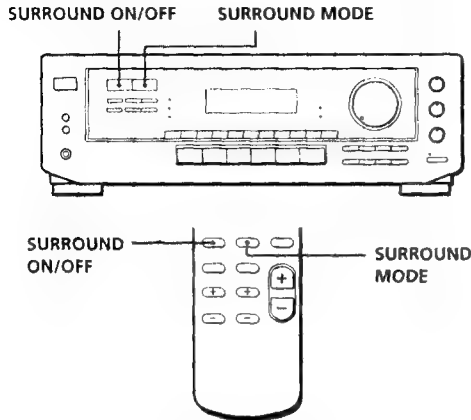

- 1 Press SURROUND ON/OFF to turn on the surround sound. One of the SUR (surround) MODE indicators lights up in the display.
- 2 Press SURROUND MODE repeatedly until the indicator for the surround mode you want lights up. Select the appropriate surround mode as follows:

Select	To
PRO LOGIC*	Decode programs processed with Dolby Surround and create the atmosphere of a movie theater.
THEATER	Add the acoustic reflections of a theater to decoded Dolby Surround signals.
HALL	Reproduce the acoustics of a rectangular concert hall. Ideal for soft, acoustic sounds.

* "DOLBY" appears in the display.



When you use the remote

Each time you press SURROUND MODE, surround mode changes as follows:



* "DOLBY" appears in the display.

To turn off surround sound

Press SURROUND ON/OFF.



You can find Dolby Surround-encoded software by looking at the packaging

However, some videos and laser discs may use Dolby Surround sound even if it's not indicated on the package.

Note

Make sure to select speaker A with the SPEAKERS A button, otherwise, you can't obtain the surround effect.

Adjusting the Effect Level (for THEATER and HALL only)

You can make the surround sound more prominent by increasing the EFFECT level. This control lets you adjust the "presence" of the surround effect in six steps (1-6).

- 1 Start playing a programme source.
- 2 Press DELAY TIME / EFFECT to select the level you prefer. The effect level ("EFFECT 1" ... "EFFECT 6") appears on the display.

Note

Changing the effect level may not produce major variations in the surround effect when used with certain playback sources.

Getting the Most Out of Dolby Pro Logic Surround Sound

To obtain the best possible Dolby Pro Logic Surround sound, first select the center mode according to the speaker system you have. Then, adjust each speaker volume and delay time.

Note that you must have at least one additional pair of speakers and/or one center speaker to do the following adjustments.

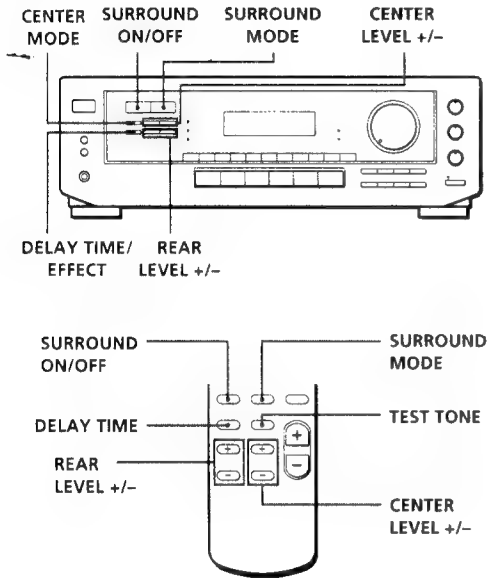

Selecting the center mode

The receiver offers you four center modes: Phantom, 3 Channel Logic, Normal, and Wide. Each mode is designed for a different speaker configuration. Select the mode that best suits your speaker's system configuration:

- 1 Press SURROUND ON/OFF to turn on surround sound.
- 2 Press SURROUND MODE repeatedly to select the Dolby surround sound field (PRO LOGIC or THEATER mode).
- 3 Press CENTER MODE repeatedly until the center mode you want appears in the display. Select the center mode as follows:

If you have	Select	So that
Front and rear speakers, no center speaker	PHANTOM	The sound of the center channel is output from the front speakers.
Front and center speakers, no rear speaker	3 CH LOGIC (3 Channel Logic)	The sound of the rear channel is output from the front speakers.
Front and rear speakers, and a small center speaker	NORMAL	The bass sound of the center channel is output from the front speakers (because a small speaker cannot produce enough bass).
Front and rear speakers, and a large center speaker	WIDE	For "complete" Dolby Pro Logic Surround sound.

(continued)

Adjusting the speaker volume

The test tone feature lets you set the volume of your speakers to the same level. (If all of your speakers have equal performance, you don't have to adjust the speaker volume.)

Using the controls on the remote lets you adjust the volume level from your listening position.

- 1 Press TEST TONE on the remote.
You will hear the test tone from each speaker sequentially.
- 2 Adjust the volume level so that the test tone from each speaker is at the same level from your listening position.
 - To adjust the level of center speaker, press CENTER LEVEL + or - on the remote.
 - To adjust the level of rear speakers, press REAR LEVEL + or - on the remote.
- 3 Press TEST TONE on the remote to turn off the test tone.

 **You can adjust all speakers at one time**
Adjust MASTER VOL on the remote or MASTER VOLUME on the receiver.

 **You can also adjust the volume level with the controls on the receiver**
After pressing TEST TONE on the remote, press REAR LEVEL + or - and CENTER LEVEL + or - to adjust the level of the rear and center speakers respectively.

 **You can increase the output level of the rear speakers**
The adjustment range of the rear speakers is preset from -15 to +10, but you can shift the range up 5 levels (-10 to +15). Hold down CENTER MODE on the receiver while turning on the power until "GAIN UP" appears on the display.
The values for the rear level remain fixed at -15 to +10 in the display, but you will be able to hear the difference in the actual output level.

To reset the rear level adjustment range, repeat this procedure to display "NORMAL".

Adjusting the delay time

You can make the surround sound more effective by delaying the output from the rear speakers (delay time). You can select from three delay times, S (15 mS), M (20 mS), and L (30 mS). For example, if you've placed the rear speakers in a large room or apart from your listening position, set the delay time shorter.

- 1 Start playing a program source encoded with Dolby Surround sound.
- 2 Press DELAY TIME on the remote or DELAY TIME/EFFECT on the receiver repeatedly to choose the delay time parameter. The current delay time appears in the display, such as "DELAY S," "DELAY M" or "DELAY L."

Note

Select the PRO LOGIC mode when you adjust the delay time using DELAY TIME/EFFECT on the receiver.

Troubleshooting

If you experience any of the following difficulties while using the receiver, use this troubleshooting guide to help you remedy the problem. Should any problem persist, consult your nearest Sony dealer.

There's no sound or only a very low-level sound is heard.

- ➔ Check that the speakers and components are connected securely.
- ➔ Make sure you select the correct component on the receiver.
- ➔ Make sure you set the SPEAKERS selector correctly.
- ➔ Press MUTING on the remote if "MUTING" is displayed.
- ➔ The protective device on the receiver has been activated because of a short circuit. ("PROTECT" flashes.) Turn off the receiver, eliminate the short-circuit problem and turn on the power again.

The left and right sounds are unbalanced or reversed.

- ➔ Check that the speakers and components are connected correctly and securely.
- ➔ Adjust the BALANCE control.

Severe hum or noise is heard.

- ➔ Check that the speakers and components are connected securely.
- ➔ Check that the connecting cords are away from a transformer or motor, and at least 10 feet (3 meters) away from a TV set or fluorescent light.
- ➔ Place your TV away from the audio components.
- ➔ Make sure you connect a ground wire to the antenna ground terminal.
- ➔ The plugs and jacks are dirty. Wipe them with a cloth slightly moistened with alcohol.

No sound is heard from the center speaker.

- ➔ Select the appropriate center mode (see page 15).
- ➔ Adjust the speaker volume appropriately (see page 16).

No sound or only a very low-level sound is heard from the rear speakers.

- ➔ Select the appropriate center mode (see page 15).
- ➔ Adjust the speaker volume appropriately (see page 16).
- ➔ Make sure you turn on the sound field surround mode function.

Radio stations cannot be tuned in.

- ➔ Check that the antennas are connected securely. Adjust the antennas and connect an outdoor antenna if necessary.
- ➔ The signal strength of the stations is too weak (when you tune in with automatic tuning). Use direct tuning.
- ➔ Make sure you set the tuning interval correctly (when you tune in AM stations with automatic tuning) (see pages 11 and 18).
- ➔ No stations have been preset or the preset stations have been cleared (when you tune in with scanning preset stations). Preset the stations (see page 12).

Surround effect cannot be obtained.

- ➔ Make sure you turn on the sound field function.
- ➔ Make sure that the front speakers are connected to the SPEAKERS A terminal.
- ➔ Make sure that SPEAKERS A and B buttons are depressed when two sets of front speakers are used.

No picture or an unclear picture is seen on the TV screen.

- ➔ Select the appropriate function on the receiver.
- ➔ Place your TV away from the audio components.

Recording cannot be made.

- ➔ Check that the components are connected correctly.

The remote does not function.

- ➔ Point the remote at the remote sensor  on the receiver.
- ➔ Remove the obstacles in the path of the remote and the receiver.
- ➔ Replace both batteries in the remote with new ones if they are weak.
- ➔ Make sure you select the correct function on the remote.

Specifications

Audio power specifications

POWER OUTPUT AND TOTAL HARMONIC DISTORTION

With 8-ohm load, both channels driven, from 20 - 20,000 Hz, rated 100 watts (STR-DE505/D450Z), 80 watts (STR-DE405) or 60 watts (STR-D350Z) per channel minimum RMS power, with no more than 0.09 % total harmonic distortion from 150 milliwatts to rated output.

Amplifier section

Surround mode (8 ohms at 1 kHz, THD 0.8 %)

Front:

STR-DE505/D450Z: 100 W/ch
 STR-DE405: 80 W/ch
 STR-D350Z: 60 W/ch

Center:

STR-DE505/D450Z: 100 W
 STR-DE405: 80 W
 STR-D350Z: 60 W
 (only in the PRO LOGIC mode)

Rear:

STR-DE505/D450Z: 100 W
 STR-DE405: 80 W
 STR-D350Z: 60 W

Dynamic power output

8 ohms:
 STR-DE505/D450Z: 150 W + 150 W
 STR-DE405: 125 W + 125 W
 STR-D350Z: 95 W + 95 W

4 ohms:

STR-DE505/D450Z: 210 W + 210 W
 STR-DE405: 165 W + 165 W
 STR-D350Z: 130 W + 130 W

Frequency response PHONO: RIAA equalization curve ± 0.5 dB
 CD, TAPE/MD, VIDEO: 10 Hz - 50 kHz ± 1 dB

Inputs

	Sensitivity	Impedance	S/N (weighting network, input level)
PHONO (MM)	2.5 mV	50 kilohms	74 dB 72 dB* (A, 2.5 mV)
CD	200 mV		
TAPE/MD, TV/DBS, VIDEO	150 mV	50 kilohms	82 dB 82 dB* (A, 150 mV)

* 78 IHF

Outputs

TAPE/MD REC OUT: Voltage 150 mV, Impedance 10 kilohms
 VIDEO AUDIO OUT: Voltage 150 mV, Impedance 10 kilohms
 MIX AUDIO OUT (STR-DE505 only) Voltage: 2 V Impedance: 10 kilohms
 PHONES: Accepts low and high impedance headphones

Muting

Full mute

BASS BOOST

+10 dB at 70 Hz

TONE

± 8 dB at 100 Hz and 10 kHz

FM tuner section

Tuning range 87.5 - 108.0 MHz
Antenna terminals 75 ohms, unbalanced
 300 ohms, unbalanced
Sensitivity Mono: 18.3 dBf, 4.5 μ V
 Stereo: 38.3 dBf, 45 μ V
Usable sensitivity 11.2 dBf, 2 μ V (IHF)

S/N

Mono: 76 dB
 Stereo: 70 dB

Harmonic distortion at 1 kHz

Mono: 0.3 %
 Stereo: 0.5 %

Separation

45 dB at 1 kHz

Frequency response

30 Hz - 15 kHz ± 0.5 dB

Selectivity

60 dB at 400 kHz

AM tuner section

Tuning range With 10 kHz interval**: 530 - 1710 kHz
 With 9 kHz interval: 531 - 1710 kHz

Antenna

Loop antenna

Usable sensitivity 50 dB/m (at 1,000 kHz or 999 kHz)

S/N

54 dB (at 50 mV/m)

Harmonic distortion

0.5 % (50 mV/m, 400 Hz)

Selectivity

At 9 kHz: 35 dB
 At 10 kHz: 40 dB

** You can change the AM tuning interval to 9 kHz. After tuning in any AM station, turn off the receiver. Hold down the TUNING + button and press the POWER button. All preset stations will be erased when you change the interval. To reset the interval to 10 kHz, repeat the procedure.

Video section

Inputs

VIDEO, TV/DBS: 1 Vp-p 75 ohms

Outputs

VIDEO: 1 Vp-p 75 ohms
 MONITOR: 1 Vp-p 75 ohms

General

System

Tuner section: PLL quartz-locked digital synthesizer system
 Pre-amplifier section: Low-noise NF type equalizer
 Power amplifier section: Pure-complimentary SEPP

Power requirements

120 V AC, 60 Hz

Power consumption

STR-DE505/D450Z: 200 W
 STR-DE405: 165 W
 STR-D350Z: 150 W

AC outlets

1 switched, total 120 W/1A Max

Dimensions

17 x 5 7/8 x 11 1/8 inches (430 x 148 x 295 mm)

Mass (Approx.)

STR-DE505/D450Z: 7.3 kg (16 lb 1 oz)
 STR-DE405/D350Z: 6.5 kg (14 lb 5 oz)

Supplied accessories

FM wire antenna (1)
 AM loop antenna (1)
 Remote controller (remote) (1)
 Size AA (R6) batteries (2)

Design and specifications are subject to change without notice.

Glossary

Center mode

Setting of speakers to enhance Dolby Pro Logic Surround mode. To obtain the best possible surround sound, select one of the following four center modes according to your speaker system.

- **NORMAL mode**

Select NORMAL mode if you have front and rear speakers and a small center speaker. Since a small speaker cannot produce enough bass, the bass sound of the center channel is output from the front speakers.

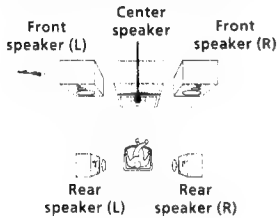

- **WIDE mode**

Select WIDE mode if you have front and rear speakers and a large center speaker. With the WIDE mode, you can take full advantage of Dolby Surround sound.

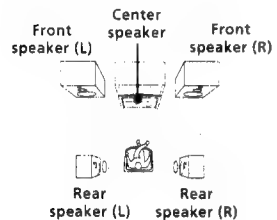

- **PHANTOM mode**

Select PHANTOM mode if you have front and rear speakers but no center speaker. The sound of the center channel is output from the front speakers.

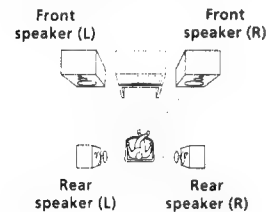

- **3 CH LOGIC mode**

Select 3 CH LOGIC mode if you have front and center speakers but no rear speaker. The sound of the rear channel is output from the front speakers to let you experience some of the surround sound without using rear speakers.

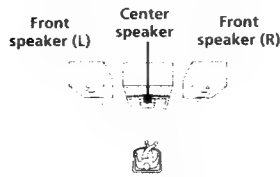

- **Delay time**

Time lag between the surround sound output from front speakers and rear speakers. By adjusting the delay time of the rear speakers, you can obtain the feeling of presence. Make the delay time longer when you have placed the rear speakers in a small room or close to your listening position, and make it shorter when you have placed them in a large room or apart from your listening position.

- **Direct tuning**

Tuning method to let you directly enter a station's frequency using the numeric buttons. Use this method if you know the frequency of the station you want.

- **Dolby Pro Logic Surround**

Decoding system of Dolby Surround sound standardized in TV programs and movies. Compared with the former Dolby Surround system, Dolby Pro Logic Surround improves sound image by using four separate channels: off-screen audio effects, on-screen dialog, left-to-right panning, and music. These channels manipulate the sound to be heard and enhance the action as it happens on the screen. To take advantage of Dolby Pro Logic, you should have at least one pair of rear speakers and/or one center speaker. You also need to select the appropriate center mode to enjoy a full effect.

- **Dolby Surround**

Encoding and decoding system of Dolby Surround sound for consumer use. Dolby Surround decodes the extra channels on the Dolby Surround-encoded sound tracks of movie videos and TV programs and produces sound effects and echoes that make the action seem to envelop you.

The receiver offers Dolby Surround as one of the pre-programmed sound fields. If you have rear or center speaker(s), we recommend that you customize the Dolby Surround sound field by selecting the appropriate center mode to take advantage of Dolby Pro Logic Surround sound.

- **Preset station**

A radio broadcasting station that is stored in memory of the receiver. Once you "preset" stations, you no longer have to tune in the stations. Each preset station is assigned its own preset number, which lets you tune them in quickly.

- **Surround sound**

Sound that consists of three elements: direct sound, early reflected sound (early reflections) and reverberative sound (reverberation). The acoustics where you hear the sound affect the way these three sound elements are heard. These sound elements are combined in such a way that you can actually feel the size and the type of a concert hall.

- **Types of sound**

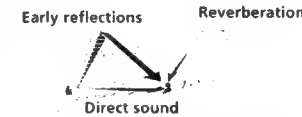

- **Transition of sound from rear speakers**

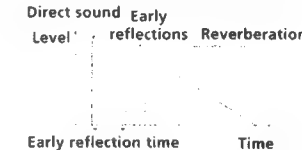

- **Test tone**

Signal given out by the receiver for adjusting the speaker volume. The test tone will come out as follows:

- **In a system with a center speaker (NORMAL/WIDE/3 CH LOGIC modes)**

The test tone is output from the front L (left), center, front R (right), and rear speakers in succession.

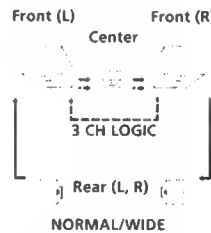

- **In a system without a center speaker (PHANTOM mode)**

The test tone is output from the front and the rear speakers alternately.

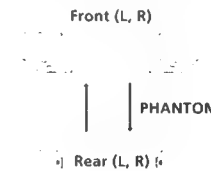

A, B

- Adjusting
 - delay time 16
 - speaker volume 16
 - tone 9
 - volume 8
- Antenna hookups 5
- Audio component hookups 5, 6
- Automatic tuning 11
- Background operation 10

C

- Center mode 15, 19
 - NORMAL mode 15, 19
 - PHANTOM mode 15, 19
 - 3 CH LOGIC mode 15, 19
 - WIDE mode 15, 19
- Connecting. *See* Hookups

D

- Delay time 16, 19
- Direct tuning 11, 19
- Dolby Pro Logic
 - Surround 19
 - getting the most out of 15
- Dolby Surround sound 14, 19
 - center mode 16, 19
- Dubbing. *See* Recording

E, F, G

- Editing. *See* Recording

H, I, J, K, L, M

- Hookups
 - AC power cord 8
 - antennas 5
 - audio components 5, 6
 - overview 4
 - speakers 6, 7
 - video component 7

N, O

- NORMAL mode 15, 19

P

- PHANTOM mode 15, 19
- Preset station 19
- Presetting
 - radio stations 12
- Preset tuning 12
- Program source
 - selecting 8, 9

Q

- Quick reference guide 23

R

- Random Music Sensor 22
- Rear panel 5, 6, 7, 8, 21
- Receiving broadcasts
 - directly 11
 - using preset stations 12
- Recording
 - on a tape 13
 - on a video tape 13
- Remote buttons 9, 10, 22
 - background operation 10

S

- Scanning
 - preset stations 12
 - radio stations 11
- Selecting a program source 8
 - using the remote 9
- Speakers
 - connection 6, 7
 - impedance 18
 - placement 6
 - selecting speaker system 7
- Storing radio stations. *See* Presetting
- Surround sound 14, 19

T

- Test tone 16, 19
- 3 CH LOGIC mode 15, 19
- Troubleshooting 17
- Tuning. *See* Receiving broadcasts

U

- Unpacking 4

V

- Video component hookups 7

W, X, Y, Z

- Watching/listening to video programs 9
- WIDE mode 15, 19

Rear Panel Descriptions

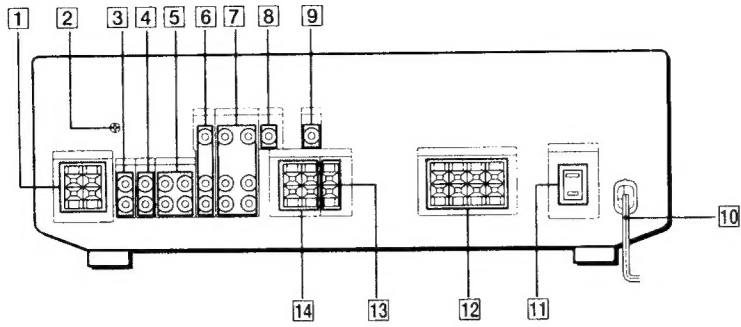

- 1 ANTENNA (AM/FM)
- 2 Ground terminal
- 3 PHONO
- 4 CD
- 5 TAPE/MD

- 6 TV/DBS
- 7 VIDEO
- 8 MONITOR
- 9 MIX AUDIO OUT (STR-DE505 only)
- 10 AC power cord

- 11 SWITCHED AC OUTLET
- 12 FRONT SPEAKERS (A/B)
- 13 SURROUND SPEAKER (CENTER)
- 14 SURROUND SPEAKERS (REAR)

Remote Button Descriptions

For buttons not described on previous pages and buttons with names different from the buttons on the main unit.

Remote Button	Operates	Function
0-9	Receiver	Selects preset numbers.
	CD player/MD recorder	Selects track numbers. 0 selects track 10.
	TV/VCR	Selects channel numbers.
>10	CD player/ Tape deck/ MD recorder	Selects track numbers over 10.
CH/PRESET +/-	Receiver	Scans and selects preset stations.
	TV/VCR	Selects preset channels.
D. SKIP	CD player	Skips discs (CD player with multi-disc changer only.)
◀▶	CD player	Searches tracks (forward or backward).
	Tape deck/MD recorder/VCR	Fastforwards or rewinds.
◀▶▶	CD player/ MD recorder	Skips tracks.
⏸	CD player/ Tape deck/MD recorder/VCR	Pauses play or record. (Also starts recording with components in record standby.)
▶	CD player/ Tape deck/MD recorder/VCR	Starts play.
■	CD player/ Tape deck/MD recorder/VCR	Stops play.
◀	Tape deck	Starts play on the reverse side.
●	Tape deck	Sets tape decks to the record standby mode.
● + ▶	Tape deck/ MD recorder/ VCR	Starts recording when pressed with ▶ (or ◀ on tape deck).

Remote Button	Operates	Function
RMS DIRECTION	Tape deck	Selects tape direction (for tape decks with the RMS* function.)
RMS CLEAR	Tape deck	Clears RMS* program (for tape decks with the RMS function.)
RMS/START	Tape deck	Programs tracks (tape deck with the RMS* function only).
ENTER	TV/VCR	Changes channels when used with 0-9.
TV/VIDEO	TV/VCR	Selects input signal: TV input or video input.
VISUAL POWER	TV/VCR	Turns on or off the power.
TV CONTROL	TV	Turns on the TV, switches the input to "TV," and sets the remote to operate the TV.
- / -	TV	Selects the channel entry mode, either one or two digit (in Europe only).
SUB CH +/-	TV	Selects preset channels for the small picture.**
POSITION	TV	Changes the position of the small picture.**
SWAP	TV	Swaps the small and the large picture.**
P IN P	TV	Activates the picture-in-picture function.**
JUMP	TV	Jumps back and forth between the previous and current channels.
ANT TV/VTR	VCR	Selects output signal from the antenna terminal: TV signal or VCR program.

* RMS: Random Music Sensor

** Only for Sony TVs with the picture-in-picture function

Receiving Broadcasts
(direct tuning)

Example: Receiving FM
102.50 MHz

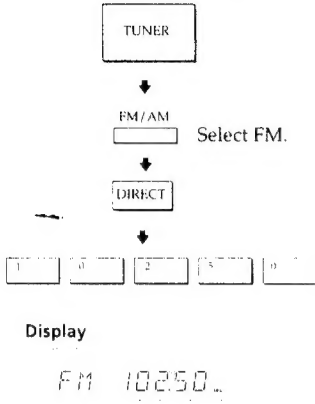

Presetting Radio Stations

Example: Presetting a station as A7

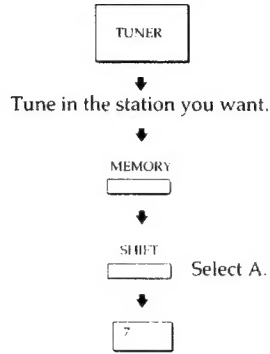

Selecting a Component

Example 1: Playing a CD

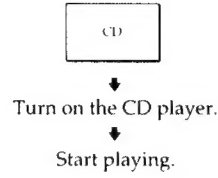

Example 2: Watching a video tape



Scanning Radio Stations (automatic tuning)

Example: Scanning FM stations

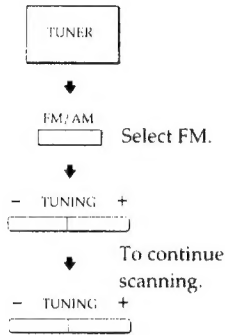

Receiving Preset Stations

Example: Receiving the station number A7

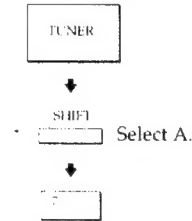

Scanning Preset Stations

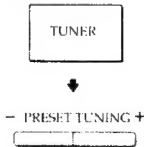

Using Pre-programmed Sound Fields

Example: Watching the video tape of a Dolby Surround-encoded movie

