

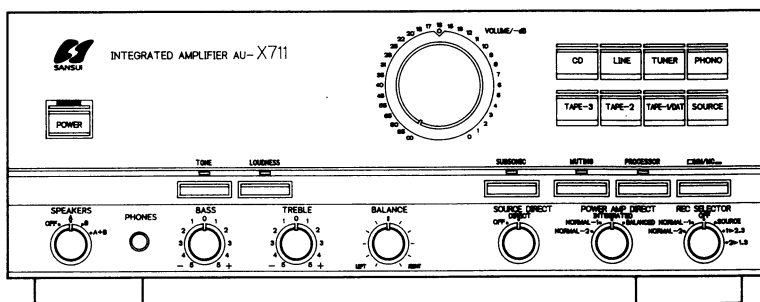

SERVICE MANUAL

AU-X711 INTEGRATED STEREO AMPLIFIER



CAUTION

1. Parts identified by the \triangle symbol on the schematic diagram and the parts list are critical for safety. Use only replacement parts that have critical characteristics recommended by the manufacturer.
2. Make leakage-current or resistance measurements to determine that exposed parts are acceptably insulated from the supply circuit before returning the appliance to the customer.

NOTE

The symbols, EU, SS and XX <EXPORT> in this Service Manual mean followings respectively.

- EU Manufactured for European market.
- SS Manufactured for Saudi Arabia market.
- XX <EXPORT> Standard Version.
- NON MARK Common Parts.

• Specifications

Power output

Min. RMS, both channels driven, from 20 to 20,000 Hz, with no more than 0.008% total harmonic distortion.
100 watts per channel into 8 ohms.

DIN

130 watts per channel into 4 ohms.

Load impedance 4 to 16 ohms

Intermodulation distortion (60 Hz: 7 kHz = 4:1 SMPTE method)
..... less than 0.008% at rated power output

Frequency response (at 1 watt)

Overall (from CD) 1 to 170,000 Hz, +0 dB, -3 dB
POWER AMP DIRECT (PIN) DC to 220,000 Hz, +0 dB, -3 dB
RIAA curve deviation (PHONO-MM, 20 Hz to 20 kHz)
..... +0.2 dB, -0.2 dB

Input sensitivity and impedance (at 1 kHz)

PHONO (MC) 300 μ V/100 ohms
PHONO (MM) 2.5 mV/47 kohms
(Max. input capability: 210 mV at 1 kHz, less than 0.01% total harmonic distortion)

CD, TUNER, LINE 150 mV/20 kohms
TAPE/DAT PLAY-1, 2, 3 150 mV/20 kohms
PROCESSOR RETURN 150 mV/20 kohms

Output level (1,000 Hz)

TAPE/DAT REC-1, 2, 3 150 mV into 47 kohms
PROCESSOR SEND 150 mV into 47 kohms

Signal to noise ratio (short-circuit, A-network)

PHONO (MM) 88 dB
PHONO (MC) 70 dB
CD, TUNER, LINE 110 dB
TAPE/DAT PLAY-1, 2, 3 110 dB
POWER AMP DIRECT 115 dB

Controls and Filter

BASS \pm 5 dB at 50 Hz
TREBLE \pm 5 dB at 15 kHz
SUBSONIC -3 dB at 16 Hz (6 dB/oct)
MUTING -20 dB
LOUDNESS +7 dB at 50 Hz
(VOLUME: -30 dB position) +5 dB at 10 kHz

Power requirements AC 120V/220V/240V,

50/60 Hz

For U.S.A. & Canada AC 120V, 60 Hz

Power consumption 560 watts 680 VA Rated

710 watts Maximum

Dimensions 430 mm (16-15/16") W

163 mm (6-7/16") H

450 mm (17-3/4") D

Weight 17.2 kg (37.9 lbs) net

19.5 kg (43.0 lbs) packed

- * Design and specifications subject to change without notice for improvements.
- * Due to local laws and regulations, this unit sold in some areas are not equipped with variable voltage selectors.

1. BLOCK DIAGRAM

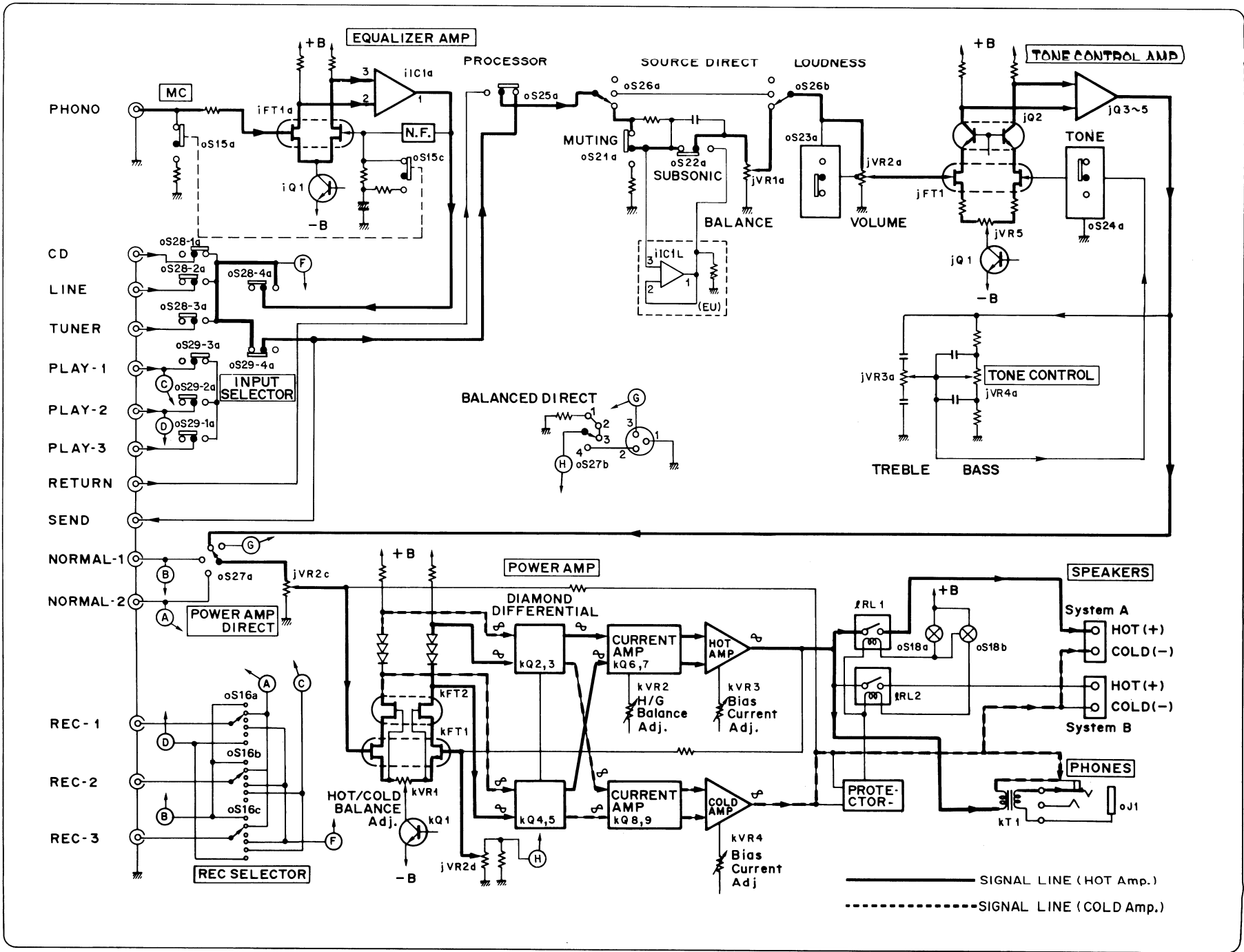

2. ADJUSTMENT

- Conditions:**
1. Ambient temperature 18°C to 28°C
 2. VOLUME Minimum
 3. SPEAKERS-A switch is ON.
 4. POWER AMP DIRECT switch is set at NORMAL.

5. If the protector relay operates, remove the bottom plate and connect a DC voltmeter as described below.
 H/G balance: Between ① and ②
 H/C balance: Between ③ and ④

2-1. F-6160 Driver AMP Adjustment (See Figs. 2-1 and 2-2)

STEP	SUBJECT	MEASURE OUTPUT	ADJUST	ADJUST FOR	REMARKS
1	HOT/GND balance adjustment (L, R-CH)	Connect a DC voltmeter between the HOT speaker terminal and the GND terminal for the left channel. Connect for the right channel in the same way.	KVR2 (F-6160) (L, R-CH)	DC 0V ±50mV	
2	HOT/COLD balance adjustment (L, R-CH)	Connect a DC voltmeter between the HOT and COLD speaker terminals for the left channel. Connect for the right channel in the same way.	kVR1 (F-6160) (L, R-CH)	DC 0V ±30mV	

Fig. 2-1 F-6160 adjustment volume position (seen from above)

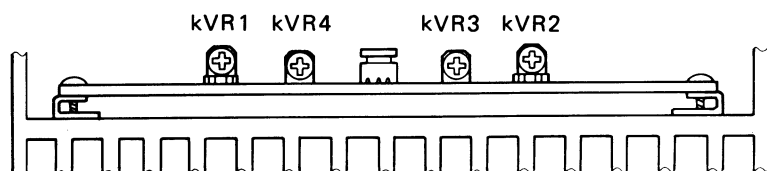

Fig. 2-2 F-6169 DC voltmeter connection points (seen from below)

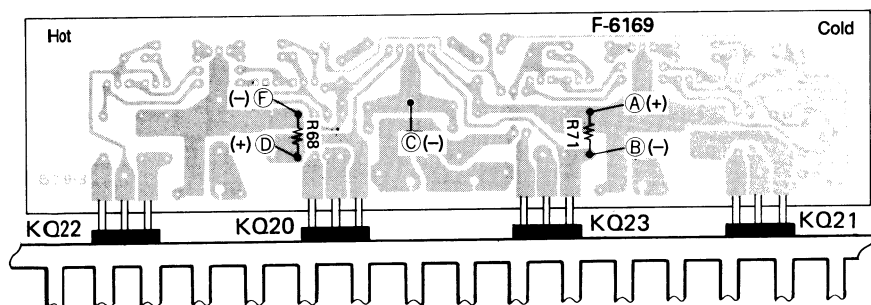
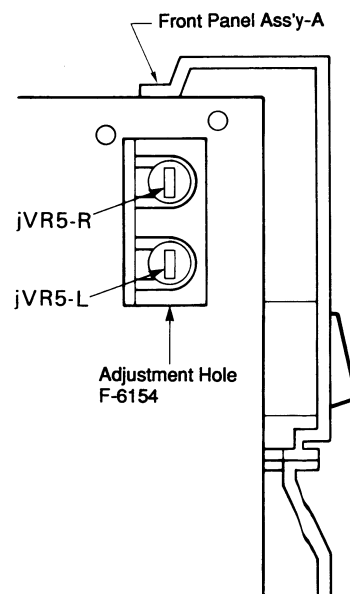

Fig. 2-3 F-6154 adjustment volume position (reached by removing left side cover)



2-2. F-6154 Flat AMP Adjustment (See Fig. 2-3)

Condition: For adjustment of this flat amp only, set VOLUME at maximum.

STEP	SUBJECT	MEASURE OUTPUT	ADJUST	ADJUST FOR	REMARKS
1	HOT/COLD balance adjustment	Connect a DC voltmeter between the HOT and COLD speaker terminals for the left channel. Connect for the right channel in the same way.	jVR5L, R (F-6154)	DC 0V ±30mV	• Set the POWER AMP DIRECT switch to INTEGRATED.

Note: When using a metal flathead screwdriver, insulate it and never allow the metal part of the screwdriver to touch the chassis within the adjustment hole.

2-3. F-6169 Power AMP Balance Current Adjustment (See Figs. 2-1 and 2-2)

- Conditions:**
1. INPUT SELECTOR CD
 2. SPEAKERS load 8 Ohms
 3. Input a 20 kHz sine wave from an oscillator to the CD input terminal, output 35 W (16.8V) at a load of 8 Ohms for five minutes to preheat, and then adjust the VOLUME to minimum.

STEP	SUBJECT	MEASURE OUTPUT	ADJUST	ADJUST FOR	REMARKS
1	Bias current adjustment (HOT amp)	Connect a DC voltmeter between ① and ② shown in Fig. 2-2 (both ends of R68) on the HOT side of the left channel. Connect for the right channel in the same way.	KVR3 (F-6160)	DC 5.5mV ±1mV	• Set the POWER AMP DIRECT switch to NORMAL.
2	Bias current adjustment (COLD amp)	Connect a DC voltmeter between ③ and ④ shown in Fig. 2-2 (both ends of R71) on the COLD side of the left channel. Connect for the right channel in the same way.	kVR4 (F-6160)	DC 5.5mV ±1mV	• After performing this adjustment (bias current), repeat adjustments 2-1 and 2-2.

3. PARTS LOCATION ON BOARD

3-1. F-6262 Input Selector Switch Board

Component Side

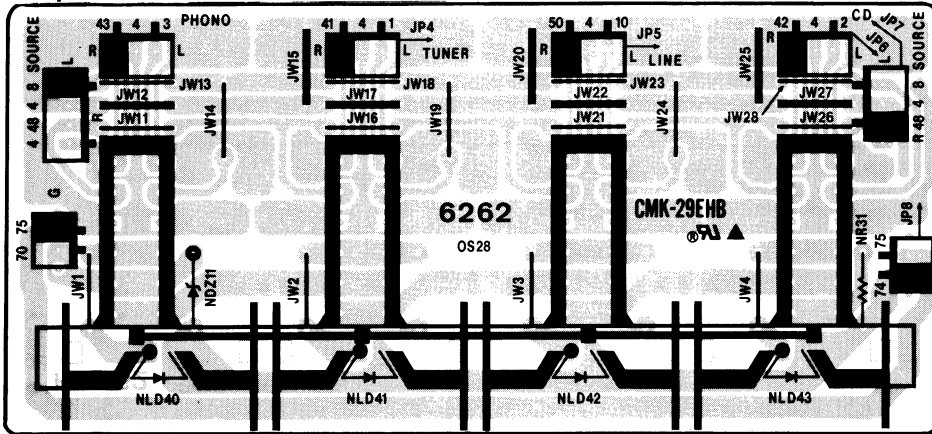

3-4. F-6167 Tone Control Board <EU>

Component Side

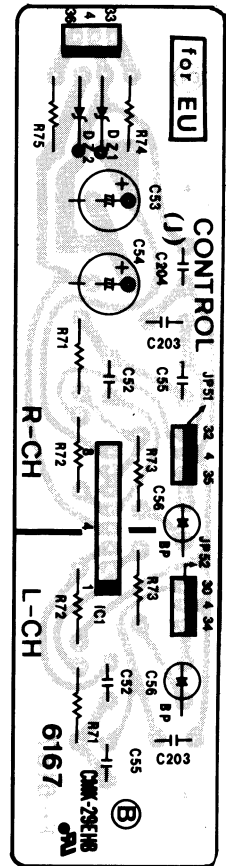

3-2. F-6263 Tape Selector Switch Board

Component Side

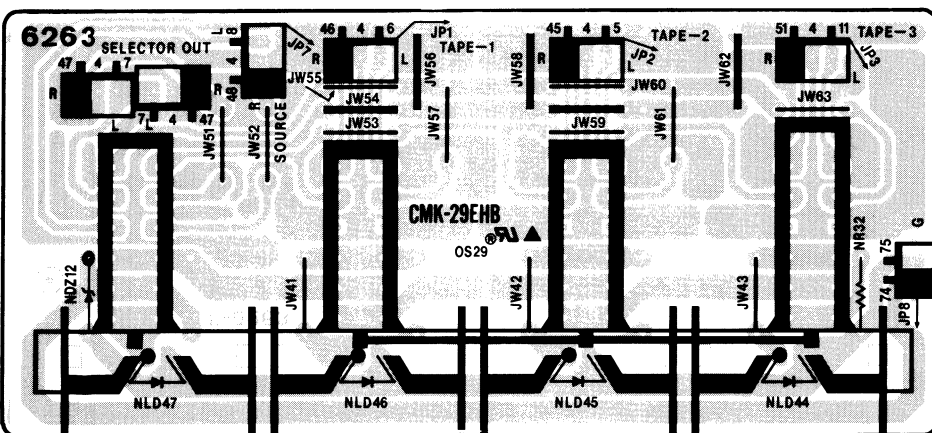

3-3. F-6260 Input Terminal Board

Component Side

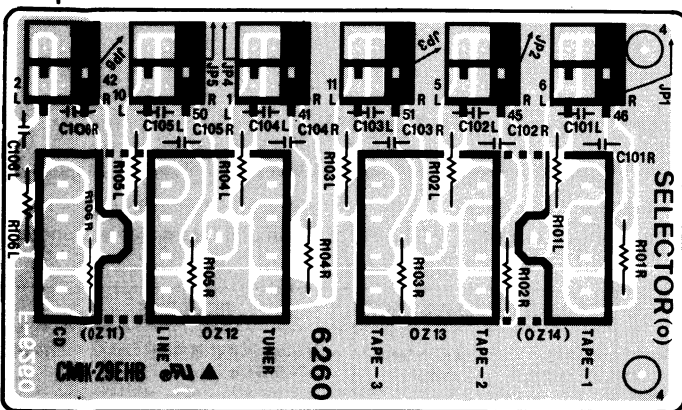

3-5. F-6261 POWER AMP DIRECT Balanced Terminal Board

Component Side

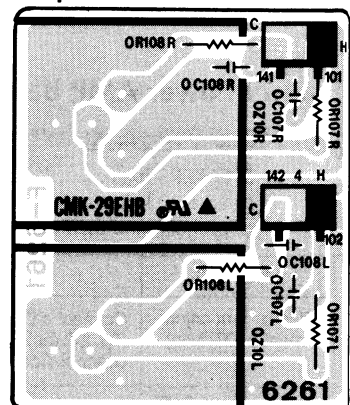

3-6. F-6157 Source Direct and Power AMP Direct Switch Board

Component Side

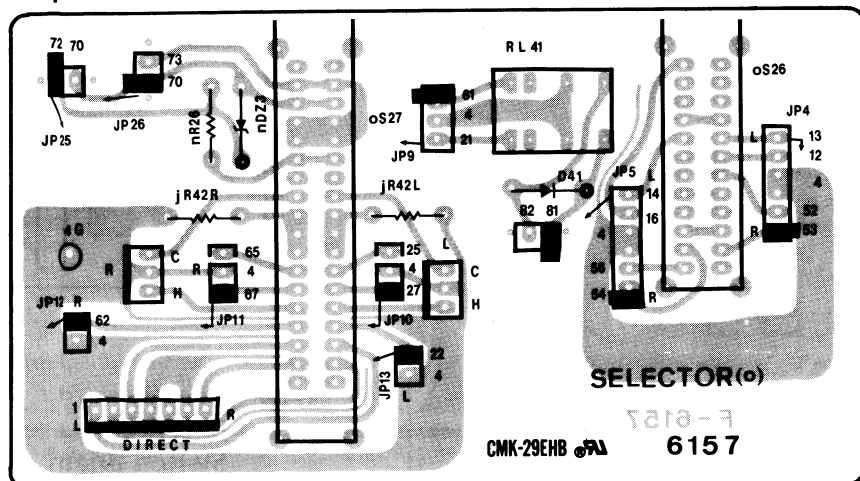

3-8. F-6152 Return Terminal Board

Component Side

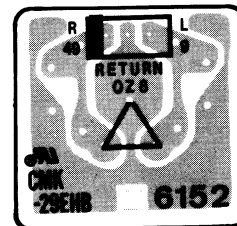

3-9. F-6153 Power AMP Direct Terminal Board

Component Side

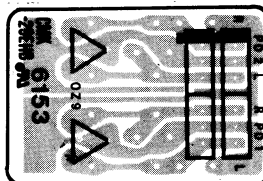

3-10. F-6151 Tape (REC), Video, Send Terminal and EQ AMP Board

Component Side

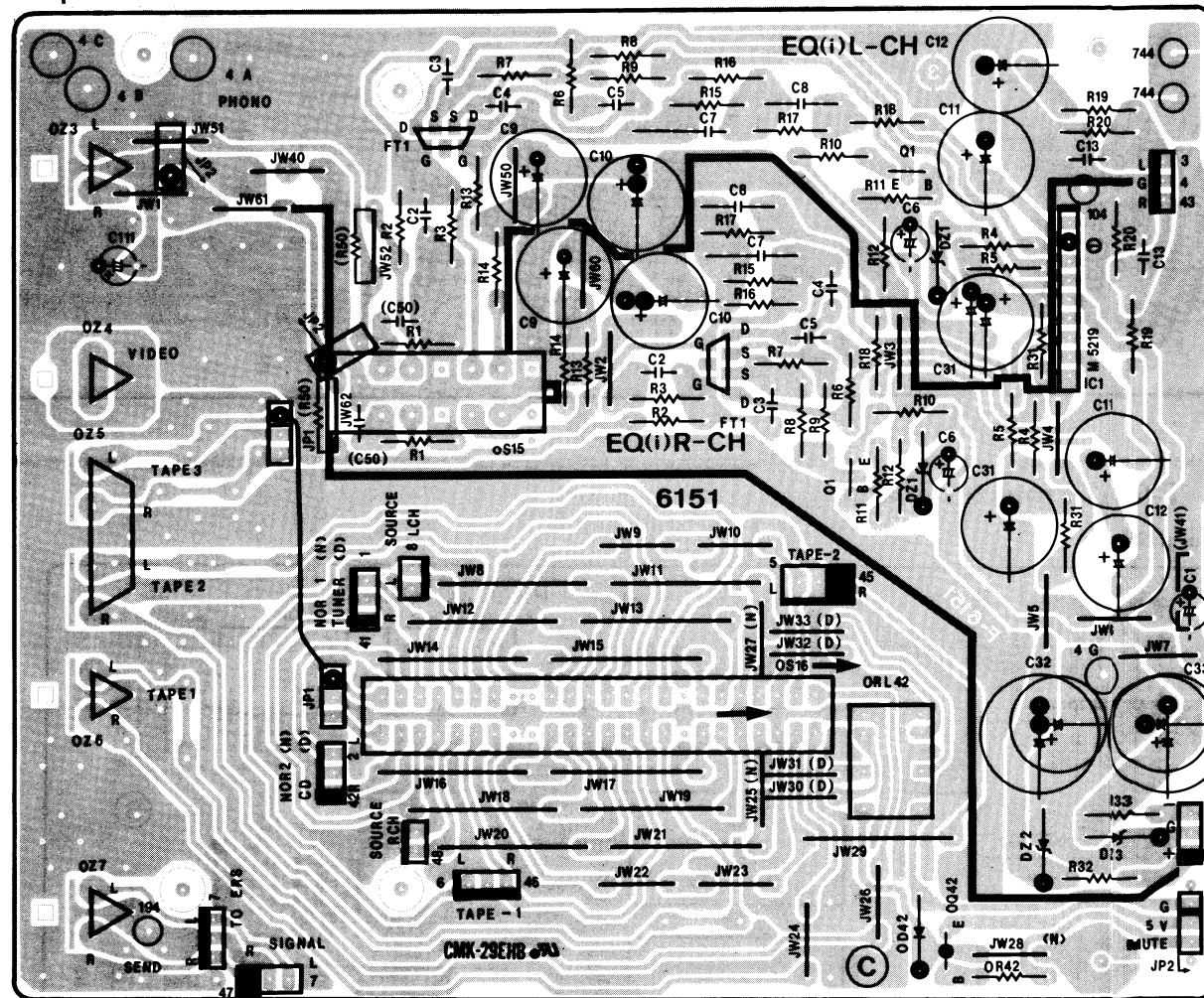

3-7. F-6154 Control AMP Board

Component Side

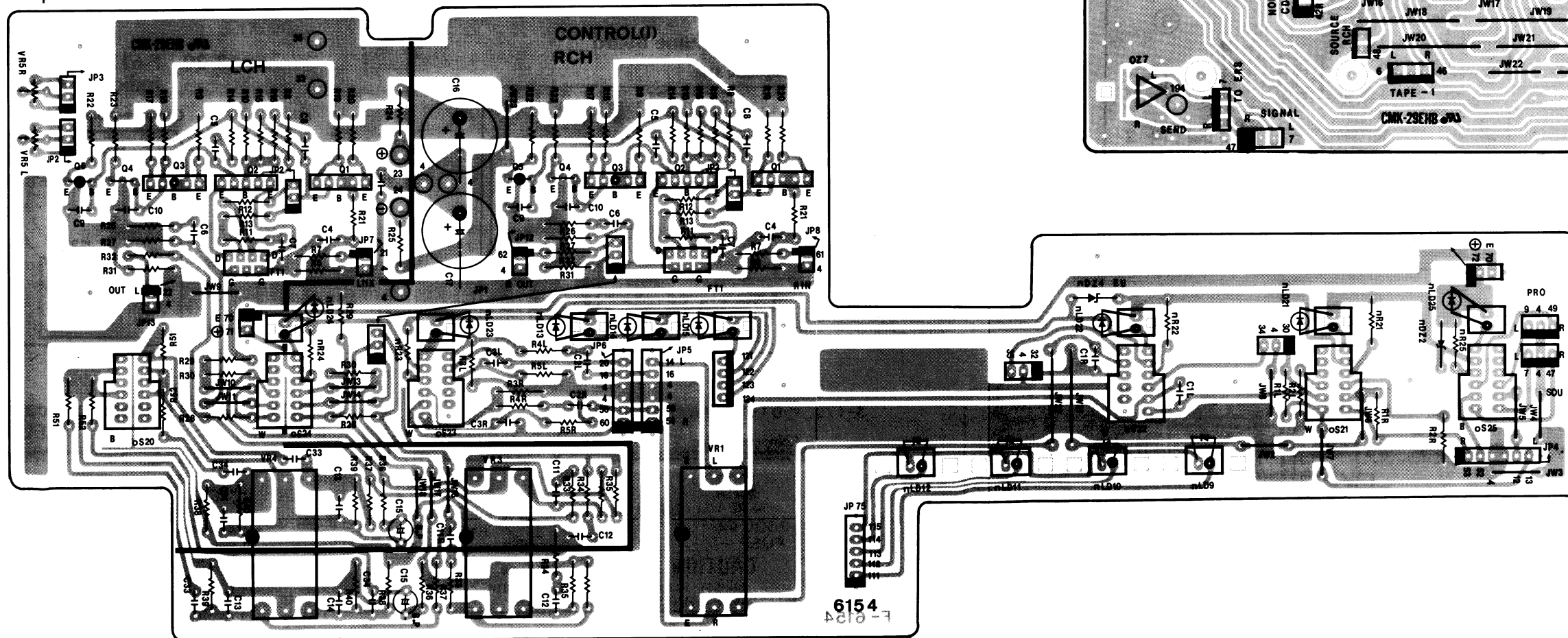

3-11. F-6158 Normal AMP Indicator Board

Component Side

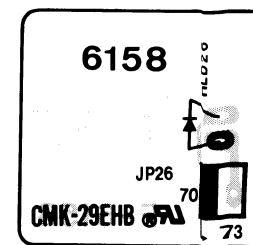

4. PARTS LIST OF BOARD

Note

- Some printed circuit boards are not supplied assembled. To separate these in this service manual, the stock numbers are not indicated for these boards. However, stock numbers for individual parts are indicated.
- Since some capacitors and resistors are omitted from parts lists in this service manual, refer to the Common Parts List for capacitors and resistors, which was issued on June 1987.
- Abbreviations in this Parts List are as follows.

•Abbreviations List

N.I.R.	: Non-Inflamable Resistor
Ce.R.	: Cement Resistor
P.C.	: Polystyrene Capacitor
M.M.C.	: Metalized Mylar Capacitor
E.C.	: Electrolytic Capacitor
E.B.	: Bi-Polar Electrolytic Capacitor
V.R.	: Variable Resistor
S.V.R.	: Semi Variable Resistor
SW.	: Switch

4-1. F-6151 TAPE(REC), VIDEO, SEND Terminal and EQ AMP Board <Stock No. 01191201>

Parts No.	Stock No.	Description
•Transistor		
iQ1	46581701	2SC1845
•FET		
iFT1	46723601 or 46723602	2SK389-BL 2SK389-V
•IC		
iIC1	46579100	M5219L
•Zener Diode		
iDZ1	46825200 or 49303400	RD6.2E-B1 05AZ6.2-Z
iDZ2	49307200 or 49307300	05AZ20-R 05AZ22-X
iDZ3	49307200 or 49307300	05AZ20-R 05AZ22-X
iC1	49452300	1μF 50V E.C.
iC6	49450900	47μF 10V E.C.
iC10	49453500	1000μF 10V E.C.
iC11	49452800	47μF 50V E.C.
iC12	49452800	47μF 50V E.C.
iC31	49451700	100μF 25V E.C.
iC32	49451800	220μF 25V E.C.
iC33	49451800	220μF 25V E.C.
oS15	07199301	Push SW., MM/MC
oS16	48164000	Slide SW., REC SELECTOR
Δ iR32, 33	46229700	390Ω 1/2W N.I.R.
	48792100	2P Terminal, PHONO
	49360600	2P Terminal, VIDEO
	48791900	4P Terminal, TAPE-2, 3
	48791800	2P Terminal, TAPE-1
	48791800	2P Terminal, SEND

4-2. F-6152 RETURN Terminal Board

Parts No.	Stock No.	Description
	48528100	2P Terminal, RETURN

4-3. F-6153 POWER AMP DIRECT Terminal Board

Parts No.	Stock No.	Description
	49262900	4P Terminal, POWER AMP DIRECT

4-4. F-6154 Control Amp Board <Stock No. 01191501=XX, SS> <Stock No. 01191505=EU>

Parts No.	Stock No.	Description
•Transistor		
jQ1	03068801	2SC2291
jQ2	03068801	2SC2291
jQ3	03011901	2SA995
jQ4	46581701	2SC1845
jQ5	46581601	2SA992
•FET		
jFT1	46723601 or 46723602 or 48785701 or 48785702	2SK389-BL 2SK389-V 2SK389-BK 2SK389-VK
jC1	48479900	0.39μF 63V M.M.C.
jC4	49424500	33pF 125V P.C.
jC5	49425900	470pF 125V P.C.
jC14	48479800	0.33μF 63V M.M.C.
jC15	48102500	10μF 25V E.B.
jC16, 17	49456000	220μF 50V E.C.
jVR1	49381400	250kΩx2 V.R., BALANCE
jVR3	48669000	100kΩx2 V.R., TREBLE
jVR4	48669000	100kΩx2 V.R., BASS
jVR5	49392200	100kΩ S.V.R., DC0V
Δ jR19, 20	46229100	120Ω 1/2W N.I.R.
Δ jR21	46231100	5.6kΩ 1/2W N.I.R.
Δ jR24, 25	46229000	100Ω 1/2W N.I.R.
•Zener Diode		
nDZ2	49301400 or 49301500	05AZ3.3-X 05AZ3.3-Z
nDZ4	49301400 or 49301500	05AZ3.3-X <EU> 05AZ3.3-Z <EU>
•LED		
nLD21	48904700	SEL3810A, MUTING
nLD22	48904700	SEL3810A, SUBSONIC
nLD23	48904700	SEL3810A, LOUDNESS
nLD24	48904700	SEL3810A, TONE
nLD25	48904700	SEL3810A, PROCESSOR

<F-6154>

Parts No.	Stock No.	Description
oS21	49386200	Push SW., MUTING
oS22	49386200	Push SW., SUBSONIC <XX, SS>
	49386100	Push SW., SUBSONIC <EU>
oS23	49386200	Push SW., LOUDNESS
oS24	49386200	Push SW., TONE
oS25	49386100	Push SW., PROCESSOR

4-5. F-6157 SOURCE DIRECT and POWER AMP DIRECT Switch Board

Parts No.	Stock No.	Description
•Zener Diode		
nDZ3	49301400	05AZ3.3-X
	or 49301500	05AZ3.3-Z
oS26	49359400	Rotary SW., SOURCE DIRECT
oS27	49386400	Rotary SW., POWER AMP DIRECT

4-6. F-6158 NORMAL AMP Indicator Board

Parts No.	Stock No.	Description
nLD26	48841100	SEL3210S, NORMAL AMP INDICATOR

4-7. F-6159 Volume Board

Parts No.	Stock No.	Description
jVR2	49382100	100k Ω ,5K V.R., VOLUME

4-8. F-6160 Driver AMP Board

<Stock No. 01191901>

Parts No.	Stock No.	Description
•Transistor		
kQ1	46581701	2SC1845
kQ2	46581701	2SC1845
	or 46947401	2SC2459
kQ3	46581701	2SC1845
	or 46947401	2SC2459
kQ4	46581601	2SA992
	or 46947301	2SA1049
kQ5	46581601	2SA992
	or 46947301	2SA1049
kQ6	46728201	2SA1145
kQ7	46728301	2SC2705
kQ8	46728201	2SA1145
kQ9	46728301	2SC2705
kQ10	03067401	2SC1845
kQ11	03067401	2SC1845
•FET		
kFT1	46723601	2SK389-BL
	or 46723602	2SK389-V
	or 48785701	2SK389-BK
	or 48785702	2SK389-VK
kFT2	46723601	2SK389-BL

<F-6160>

Parts No.	Stock No.	Description
	or 46723602	2SK389-V
	or 48785701	2SK389-BK
	or 48785702	2SK389-VK
kD1	03104800	Varistor SV-03
	or 03401700	Varistor MV103
kD2	03104800	Varistor SV-03
	or 03401700	Varistor MV103
•Zener Diode		
kDZ1	46825300	RD6.2E-B2
	or 49303400	05AZ6.2-Z
kDZ2	03171500	RD22F B
Δ kR51	46228400	33 Ω 1/2W N.I.R.
Δ kR52	46228400	33 Ω 1/2W N.I.R.
Δ kR53	46625100	470 Ω 2W N.I.R.
kC1	49329700	750pF 100V P.C.
kC2	49452500	4.7 μ F 50V E.C.
kC3	49452500	4.7 μ F 50V E.C.
kC4	49451100	220 μ F 10V E.C.
kC5	49423300	4pF 125V P.C.
kC6	49423300	4pF 125V P.C.
kC7	49456100	470 μ F 50V E.C.
kC8	49456100	470 μ F 50V E.C.
kC9	49451700	100 μ F 25V E.C.
kC10	49456000	220 μ F 50V E.C.
kC11	49456000	220 μ F 50V E.C.
kC12	49456000	220 μ F 50V E.C.
kC13	49456000	220 μ F 50V E.C.
kVR1	48700000	100 S.V.R., HOT/COLD Balance adj.
kVR2	48700200	500 S.V.R., HOT/COLD Balance adj.
kVR3	48078600	1k Ω S.V.R., Bias adj.
kVR4	48078600	1k Ω S.V.R., Bias adj.

4-9. F-6161 Protector Board

<Stock No. 01192001>

Parts No.	Stock No.	Description
Δ kR74	49224000	10 Ω 2W N.I.R.
Δ kR75	49224000	10 Ω 2W N.I.R.
Δ kR82	46248700	33 Ω 1W N.I.R.
Δ kR83	46248700	33 Ω 1W N.I.R.
kC20	49250700	0.047 μ F 100V P.C.
kC21	49250700	0.047 μ F 100V P.C.
kT1	46841810	Output Transformer
•Transistor		
IQ1	46188701	2SC1815
	or 46367301	2SC2458
IQ2	46188701	2SC1815
	or 46367301	2SC2458
•IC		
IIC1	46207600	TA7317P
•Diode		
ID1	03117600	1S2473T77
	or 46086000	1S1588TP-3
ID2	03117600	1S2473T77
	or 46086000	1S1588TP-3
ID3	03117600	1S2473T77

<F-6161>

Parts No.	Stock No.	Description
ID4	or 46086000	1S1588TP-3
	03117600	1S2473T77
ID5	or 46086000	1S1588TP-3
	03117700	10E-2
ID6	03117600	1S2473T77
ID7	or 46086000	1S1588TP-3
	48123600	11E2
ID8	48123600	11E2
IC1	48101900	100μF 10V E.B.
IC2	48101900	100μF 10V E.B.
IC4	48813000	1μF 50V E.B.
Δ IR14	46230000	680Ω 1/2W N.I.R.
Δ IR17	46230000	680Ω 1/2W N.I.R.
IRL1	49358900	Relay
IRL2	49358900	Relay
	48592700	8P Terminal, SPEAKERS

4-10. F-6162 Phones Jack Board

Parts No.	Stock No.	Description
oJ1	49479900	Jack, PHONES

4-11. F-6164 SPEAKERS Switch Board

Parts No.	Stock No.	Description
oS18	49359200	Rotary SW., SPEAKERS

4-12. F-6165 Power Supply Board

<Stock No. 01192301>

Parts No.	Stock No.	Description
•Transistor		
mQ1	46728901	2SC3298
mQ2	46728801	2SA1306
mQ3	46581701	2SC1845
mQ4	46581601	2SA992
mQ30	03083901	2SD313HP
	or 48509401	2SD1761
•FET		
mFT1, 2	46643501	2SK163-K2
	or 46643602	2SK117-GR
•Diode		
Δ mD4, 5	48667600	FMU-22S
Δ mD6, 7	48667700	FMU-22R
Δ mD8~11	03117700	10E-2
Δ mD30, 31	03117700	10E-2
•Zener Diode		
mDZ1, 2	46831100	RD33E-B3
	or 49309000	05AZ33-Y
mDZ30	49308000	05AZ24-R
	or 49308100	05AZ27-X

<F-6165>

Parts No.	Stock No.	Description
Δ mR1, 2	46227800	10Ω 1/2W N.I.R.
Δ mR3, 4	46626500	6.8kΩ 2W N.I.R.
Δ mR30	46624300	100Ω 2W N.I.R.
Δ mR31	46230400	2.2kΩ 2W N.I.R.
Δ mR32	46625900	2.2kΩ 2W N.I.R.
Δ mC1, 2		
	08680400	0.01μF 500V C.C.
mC4, 5	49456200	1000μF 50V E.C.
mC6, 7	49452900	100μF 50V E.C.
mC8, 9	49456100	470μF 50V E.C.

4-13. F-6166 Power Fuse Board

Parts No.	Stock No.	Description
Δ pF1	48721700	Fuse 4A <XX, SS>
Δ	49297500	Fuse 4A <EU>
Δ pF2	48721700	Fuse 4A <XX, SS>

4-14. F-6167 Tone Control Board <EU>

<Stock No. 01192505>

Parts No.	Stock No.	Description
•IC		
jIC1	46579100	M5219L
•Zener Diode		
jDZ1	49307200	05AZ20
	or 49307300	05AZ22
Δ jR74, 75	46230400	1.5kΩ 1/2W N.I.R.
jC52	48479600	0.22μF 63V M.M.C.
jC53, 54	49451800	220μF 25V E.C.
jC55	48479600	0.22μF 63V M.M.C.
jC56	48103600	3.3μF 50V E.B.

4-15. F-6169 Power AMP Board

<Stock No. 01192601>

Parts No.	Stock No.	Description
•Transistor		
kQ12, 13	46728301	2SC2705
kQ14, 15	46728201	2SA1145
kQ16, 17	46728901	2SC3298
kQ18, 19	46728801	2SA1306
•Diode		
kD3~6	46727900	1S2091
Δ kR60~63	46229000	100Ω 1/2W N.I.R.
Δ kR64, 65	46229900	560Ω 1/2W N.I.R.
Δ kR66, 67	46229100	120Ω 1/2W N.I.R.
Δ kR68~71	48062500	0.22Ω 5W C.e.R.
Δ kR72, 73	49224000	10Ω 2W N.I.R.
Δ kR76~79	49205400	4.7Ω 1/2W N.I.R.
kC14~17	49253300	39pF 100V P.C.
kC18, 19	49250700	0.047μF 100V P.C.

<F-6169>

Parts No.	Stock No.	Description
kL1, 2	49250100	0.8μH Coil
•Transistor		
IQ3	46367101	2SC2603
IQ4	46367001	2SA1115
	or 46367201	2SA1048
•Diode		
ID9	03117600	1S2473T77
	or 46086000	1S1588TP-3
IC13	49452800	47μF 50V E.C.
IC14	49425900	470pF 125V P.C.

Caution: Power transistors are not included in this board assembly.
See page 10 for the code numbers for the power transistors.

4-16. F-6177 Protector Indicator Board

Parts No.	Stock No.	Description
nLD31	48841300	SEL3813A, PROTECTOR

4-17. F-6260 Input Terminal Board

Parts No.	Stock No.	Description
	49359700	2P Terminal, CD
	49359800	4P Terminal, TUNER, LINE
	49359900	6P Terminal, TAPE-1~3

4-18. F-6261 Power AMP Direct Balanced Terminal Board

Parts No.	Stock No.	Description
	49478700	Neutral Connector

4-19. F-6262 Input Selector Switch Board

Parts No.	Stock No.	Description
•Zener Diode		
nDZ11	49301400	05AZ3.3-X
	or 49301500	05AZ3.3-Z
•LED		
nLD40	48841300	SEL3813A, PHONO
nLD41	48841300	SEL3813A, TUNER
nLD42	48841300	SEL3813A, LINE
nLD43	48841300	SEL3813A, CD
oS28	49437000	Push SW., TUNER, LINE, CD PHONO

4-20. F-6263 Tape Selector Switch Board

Parts No.	Stock No.	Description
•Zener Diode		
nDZ12	49301400	05AZ3.3-X
	or 49301500	05AZ3.3-Z
•LED		
nLD44	48841300	SEL3813A, TAPE-3
nLD45	48841300	SEL3813A, TAPE-2
nLD46	48841300	SEL3813A, TAPE-1
nLD47	48841300	SEL3813A, SOURCE
oS29	49436700	Push SW., TAPE-1~3, SOURCE

5. OTHER PARTS

5-1. Rear View

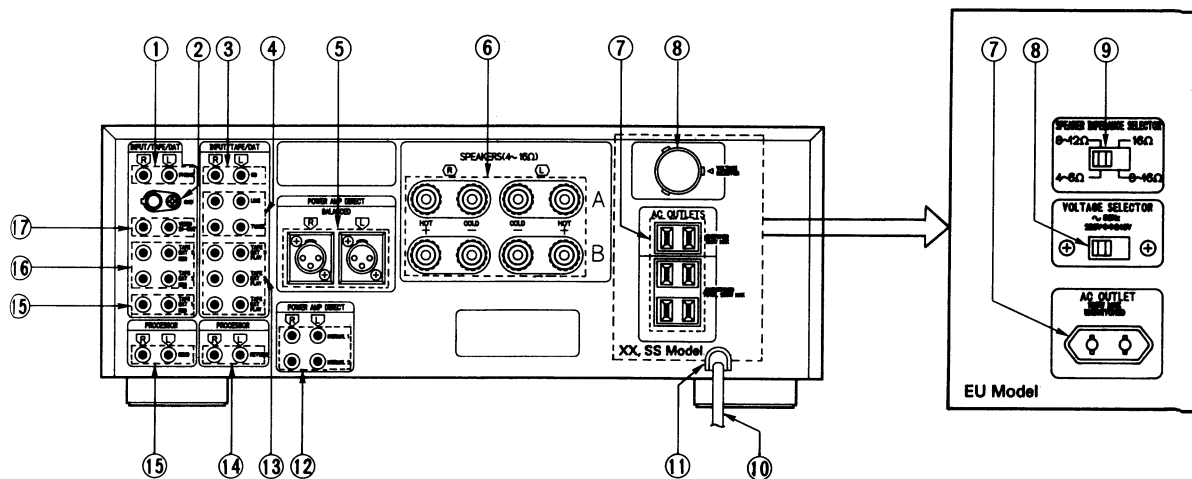

5-2. Top View

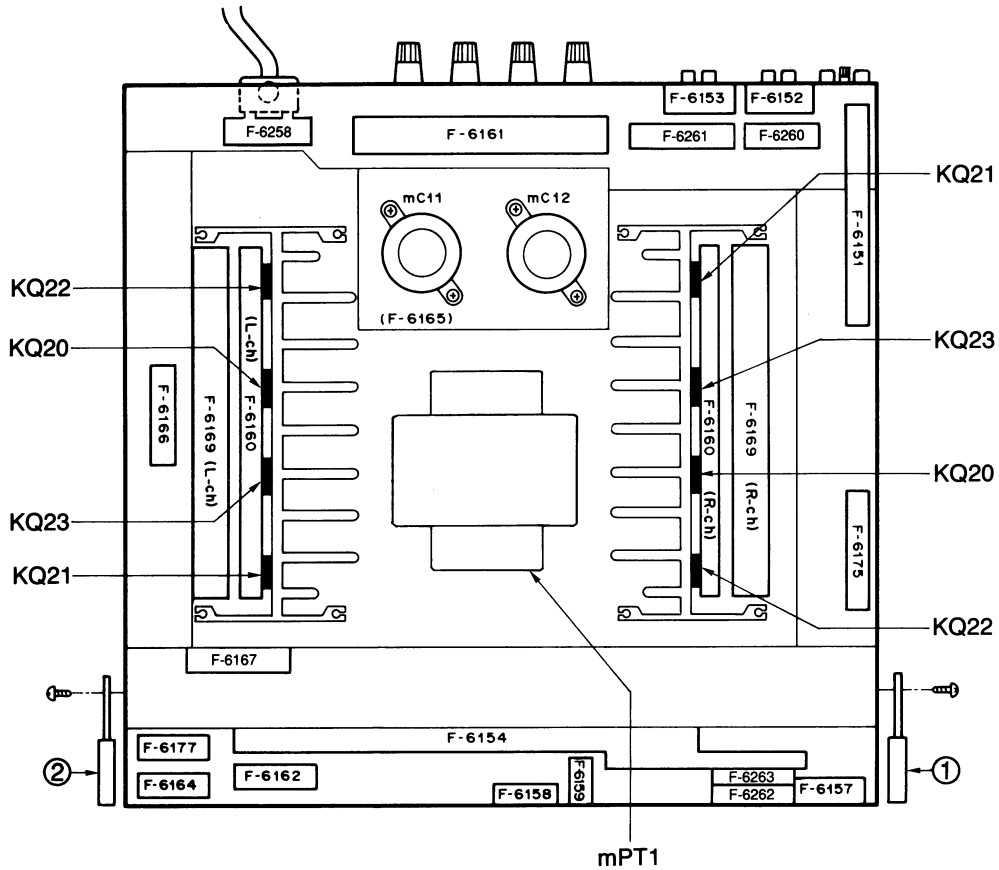

Parts List <Rear View>

Parts No.	Stock No.	Description
1	48792100	2P Terminal, PHONO
2	48587600	Ground Terminal
3	49359700	2P Terminal, CD
4	49359800	4P Terminal, LINE, TUNER
5	49478700	Neutral Connector
6	48592700	8P Terminal, SPEAKERS
Δ 7	46730400	AC OUTLET <XX, SS>
Δ	46161000	AC OUTLET <EU>
Δ 8	48175200	Plug A (Voltage Selector) <XX, SS>
Δ	07204700	Slide Switch (Voltage Selector) <EU>
Δ 9	07204700	Slide Switch (Speaker Impedance Selector) <EU>
Δ 10	46321000	Power Supply Cord <XX>
Δ	48837700	Power Supply Cord <SS>
Δ	46128900	Power Supply Cord <EU>
11	39104900	Strain Relief <XX>
	48913500	Strain Relief <SS, EU>
12	49262900	4P Terminal, POWER AMP DIRECT
13	49359900	6P Terminal, TAPE/DAT1~3 (PLAY)
14	48528100	2P Terminal, RETURN
15	48791800	2P Terminal, SEND, TAPE1
16	48791900	4P Terminal, TAPE/DAT2, 3 (REC)
17	49360600	2P Terminal, VIDEO IN-OUT

Parts List <Top View>

Parts No.	Stock No.	Description
1	27743900	Side Cover (Right)
2	27744000	Side Cover (Left)
mC11, 12	49448700	10000μF 71V E.C.
Δ KQ20, 21	48729301	2SC3284
Δ KQ22, 23	48729201	2SA1303
Δ mPT1	15036409	Power Transformer <XX, SS>
Δ	15036405	Power Transformer <EU>
	49235900	M4x8 Flange Head Screw (Copper)
	49251100	M3x8 Flange Head Screw (Copper)
	49196700	M3x14 Flange Head Screw (Copper)
	49196600	M4x8 Binding Screw (Copper)
	49196400	M3x8 Binding Screw (Copper)

5-3. Front View

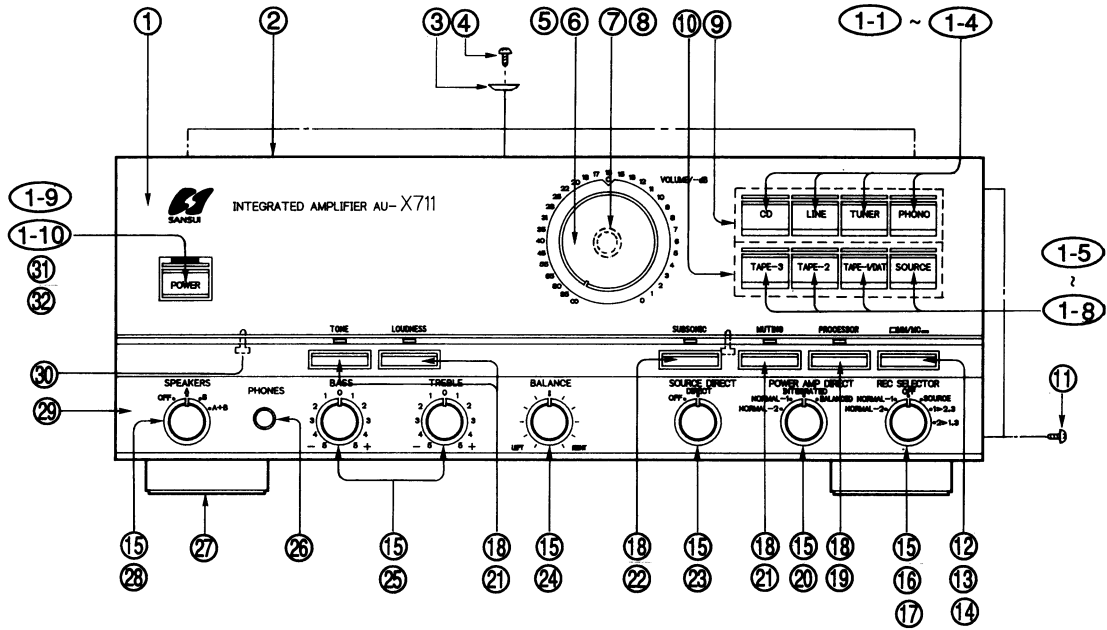

Parts List <Front View>

Parts No.	Stock No.	Description	Parts No.	Stock No.	Description
1	27809600	Front Panel-A Ass'y	14	27712710	Rod Ass'y
1-1	27696500	Knob, CD	15	27697600	Knob, SPEAKERS, BASS, TREBLE, BALANCE, REC SELECTOR, SOURCE DIRECT, POWER AMP DIRECT
1-2	27696600	Knob, LINE	16	48719310	Rotary Flexible Wire
1-3	27696700	Knob, TUNER	17	48164000	Slide SW., REC SELECTOR
1-4	27696800	Knob, PHONO	18	27715400	Knob, SUBSONIC, LOUDNESS, TONE, MUTING, PROCESSOR
1-5	27696900	Knob, TAPE-3	19	49386100	Push SW., PROCESSOR
1-6	27697000	Knob, TAPE-2	20	49359500	Rotary SW., POWERAMP DIRECT
1-7	27697100	Knob, TAPE-1/DAT	21	49386200	Push SW., MUTING, TONE, LOUDNESS
1-8	27697200	Knob, SOURCE	22	49386200	Push SW., SUBSONIC <XX, SS>
1-9	27748600	Knob, POWER	23	49386100	Push SW., SUBSONIC <EU>
1-10	27296900	Spring	24	49359400	Rotary SW., SOURCE DIRECT
2	27700800	Bonnet <XX, SS>	25	49381400	250kΩ V.R., BALANCE
	27795900	Bonnet Ass'y <EU>	26	48669000	100kΩ V.R., BASS, TIEBLE
3	27319200	Bonnet Holder	27	49479900	Jack, PHONES
4	00458500	M4x8 Bell Head Screw	28	27723200	Leg Ass'y
5	27697700	Knob, VOLUME	29	49359200	Rotary SW., SPEAKERS
6	49382100	100kΩ V.R., VOLUME	30	27826800	Front Panel-B Ass'y
7	47576700	Shaft Ring, VOLUME	31	46267900	M3x8 Screw, Front Panel A&B
8	27775500	Teflon Washer, VOLUME	Δ 32	48113300	Push SW., POWER
9	49437000	Push SW., CD, LINE, TUNER, PHONE,			
10	49436700	Push SW., TAPE-3, TAPE-2, TAPE-1, SOURCE	Δ 32	46425800	10000pF 400V C.C.
11	46669100	M4x8 Binding Head Screw	Δ	46943200	10000pF 400V C.C.
12	27715500	Knob, MM/MC			
13	07199301	Push SW., MM/MC			

6. SCHEMATIC DIAGRAM

6-1. EQ & Control AMP Section

* Design and specifications subject to changes without notice for improvements.

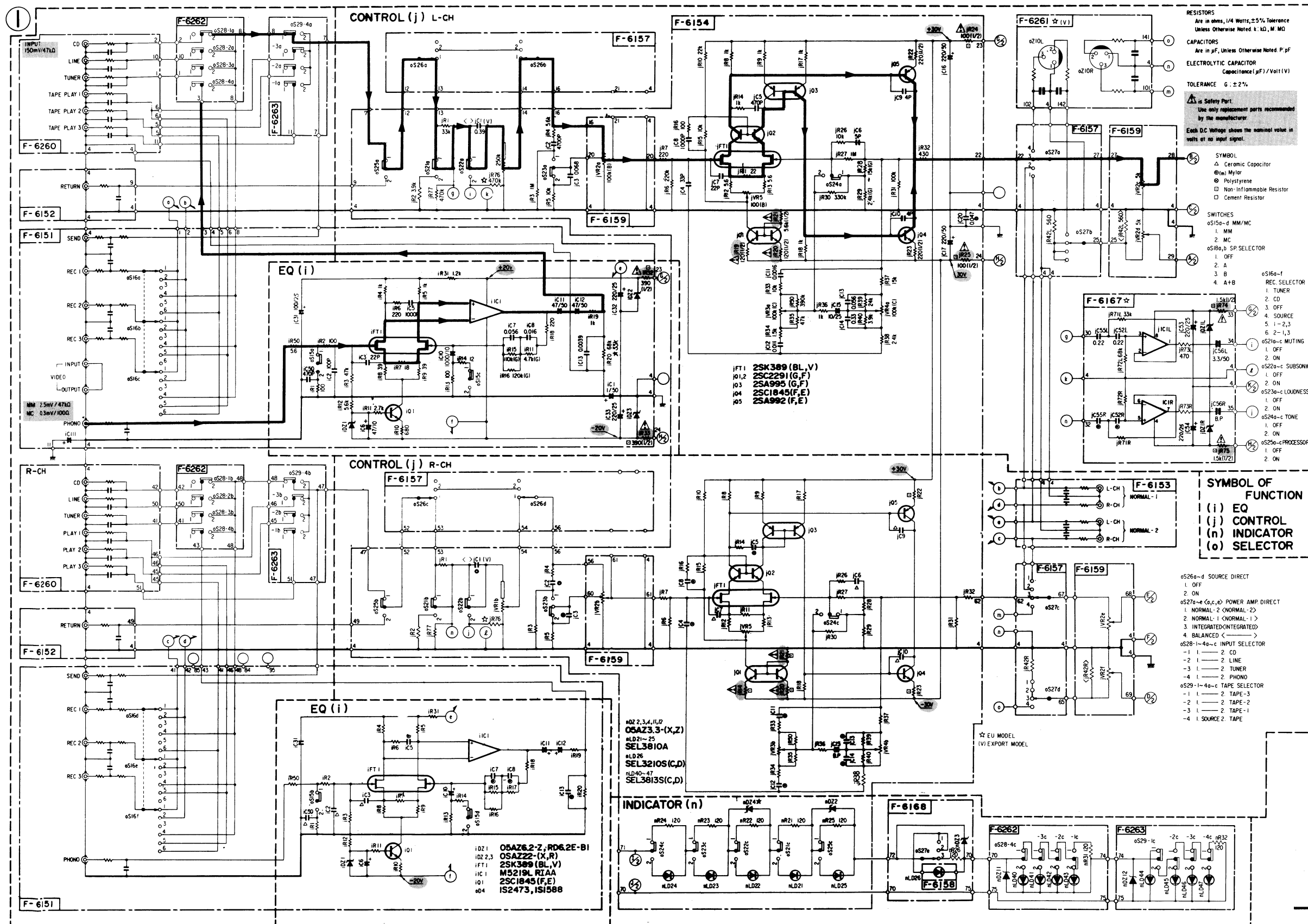

RESISTORS
Are in ohms, 1/4 Watts, ±5% Tolerance
Unless Otherwise Noted: K, M, MG

CAPACITORS
Are in pF, Unless Otherwise Noted: P, pF

ELECTROLYTIC CAPACITOR
Capacitance (µF) / Volt (V)

TOLERANCE G: ±2%

is Safety Part
Use only replacement parts recommended by the manufacturer.
Each D.C. Voltage shows the nominal value in volts of its input signal.

SYMBOL
△ Ceramic Capacitor
Ⓜ Mylar
Ⓟ Polystyrene
□ Non-Flammable Resistor
Ⓛ Cement Resistor

SWITCHES
o515a-d MM/MC
1 MM
2 MC

o518a,b SP-SELECTOR
1 OFF
2 A
3 B
4 A+B

o516a-f REC. SELECTOR
1. TUNER
2. CD
3. OFF
4. SOURCE
5. 1-2,3
6. 2-1,3

o521a-c MUTING
1. OFF
2. ON

o522a-c SUBSONIC
1. OFF
2. ON

o523a-c LOUDNESS
1. OFF
2. ON

o524a-c TONE
1. OFF
2. ON

o525a-c PROCESSOR
1. OFF
2. ON

SYMBOL OF FUNCTION
(i) EQ
(j) CONTROL
(n) INDICATOR
(o) SELECTOR

o526a-d SOURCE DIRECT
1. OFF
2. ON

o527a-e (a,c,e) POWER AMP DIRECT
1. NORMAL-2 (NORMAL-2)
2. NORMAL-1 (NORMAL-1)
3. INTEGRATED (INTEGRATED)

o528-1-4a-c INPUT SELECTOR
-1 1 CD
-2 1 LINE
-3 1 TUNER
-4 1 PHONO

o529-1-4a-c TAPE SELECTOR
-1 1 TAPE-3
-2 1 TAPE-2
-3 1 TAPE-1
-4 1 SOURCE 2 TAPE

o527a-e (a,c,e) POWER AMP DIRECT
1. NORMAL-2 (NORMAL-2)
2. NORMAL-1 (NORMAL-1)
3. INTEGRATED (INTEGRATED)

o528-1-4a-c INPUT SELECTOR
-1 1 CD
-2 1 LINE
-3 1 TUNER
-4 1 PHONO

o529-1-4a-c TAPE SELECTOR
-1 1 TAPE-3
-2 1 TAPE-2
-3 1 TAPE-1
-4 1 SOURCE 2 TAPE

o527a-e (a,c,e) POWER AMP DIRECT
1. NORMAL-2 (NORMAL-2)
2. NORMAL-1 (NORMAL-1)
3. INTEGRATED (INTEGRATED)

o528-1-4a-c INPUT SELECTOR
-1 1 CD
-2 1 LINE
-3 1 TUNER
-4 1 PHONO

o529-1-4a-c TAPE SELECTOR
-1 1 TAPE-3
-2 1 TAPE-2
-3 1 TAPE-1
-4 1 SOURCE 2 TAPE

o527a-e (a,c,e) POWER AMP DIRECT
1. NORMAL-2 (NORMAL-2)
2. NORMAL-1 (NORMAL-1)
3. INTEGRATED (INTEGRATED)

o528-1-4a-c INPUT SELECTOR
-1 1 CD
-2 1 LINE
-3 1 TUNER
-4 1 PHONO

o529-1-4a-c TAPE SELECTOR
-1 1 TAPE-3
-2 1 TAPE-2
-3 1 TAPE-1
-4 1 SOURCE 2 TAPE

- 1S1588
- 1S2091
- 1S2473
- 10E2
- 11E2
- SV-03
- MV103
- RD22F
- RD33E
- RD6.2E
- 06AZ20
- 06AZ22
- 06AZ24
- 06AZ27
- 06AZ3.3
- 06AZ33
- 06AZ3.2
- 25A1049
- 25A1145
- 25A992
- 25C1816
- 25C1845
- 25C2706
- FMU-22S
- FMU-22R
- 25K117
- 25K163
- 25K389
- SEL3210S
- SEL3810A
- SEL3813A
- TA7317P
- 25A995
- 25C2291
- M5219L
- 25D1761
- 25D313
- 25A1306
- 25C3298
- 25C2458
- 25A1303
- 25C3284

1
2
3
4
5

Signal Line

6-2. Power AMP & Power Supply Section

* Design and specifications subject to changes without notice for improvements.

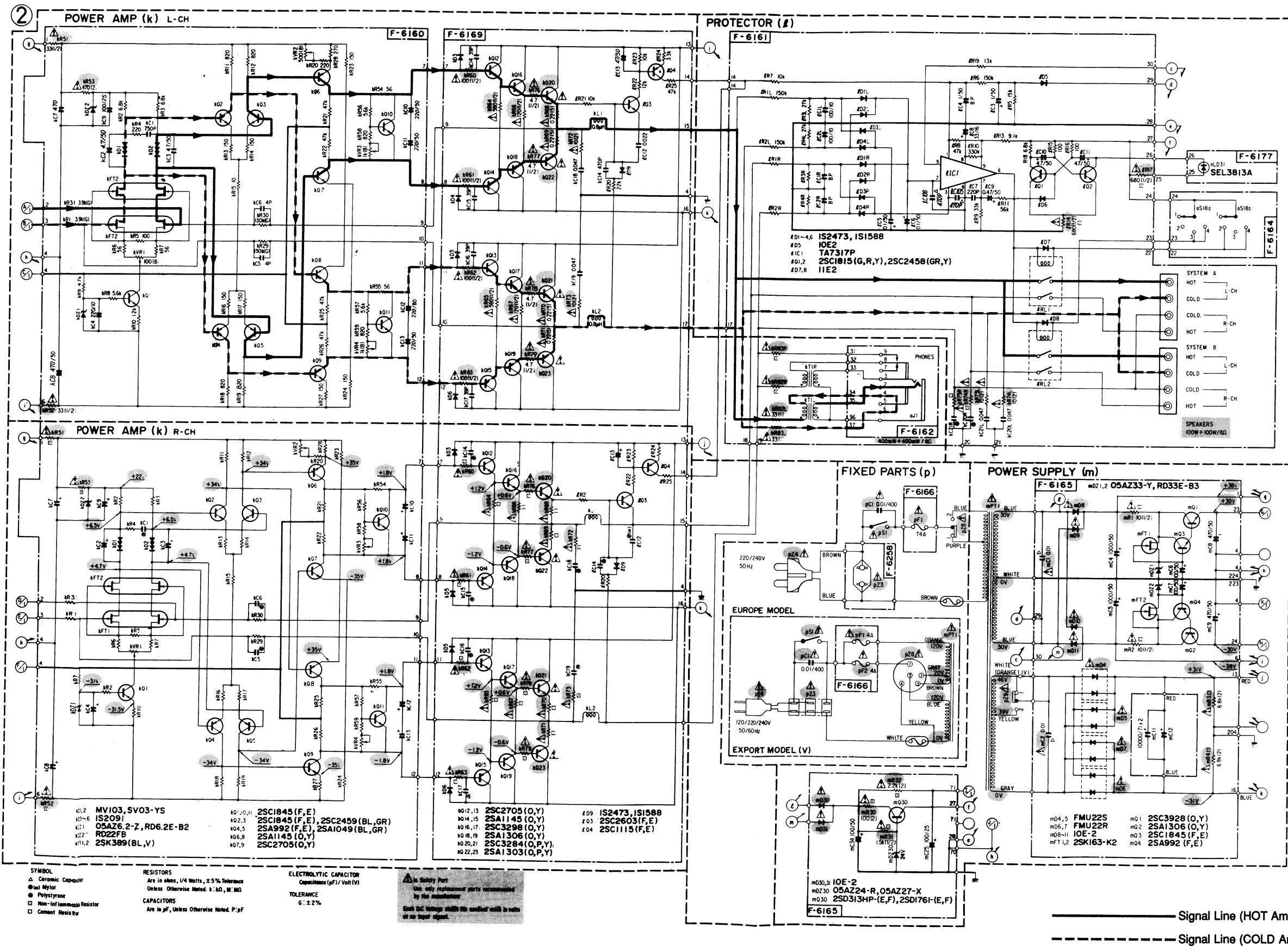

- 1S1588
- 1S2091
- 1S2473
- 10E2
- 11E2
- SV-03
- MV103
- RD22F
- RD33E
- RD6.2E
- 06AZ20
- 06AZ22
- 06AZ24
- 06AZ27
- 06AZ33
- 06AZ33
- 06AZ26.2
- 2SK117
- 2SK163
- 2SA1049
- 2SA1145
- 2SA992
- 2SC1815
- 2SC1845
- 2SC2705
- 2SA1048
- 2SA1115
- 2SC2459
- 2SC2803
- 2SC2458
- 2SA1306
- 2SC3298
- 2SA1303
- 2SC3284
- 2SC2458
- 2SA1048
- 2SA1115
- 2SC2459
- 2SC2803

7. INTERIOR BLOCK DIAGRAM OF IC

• TA7317P <Protector>

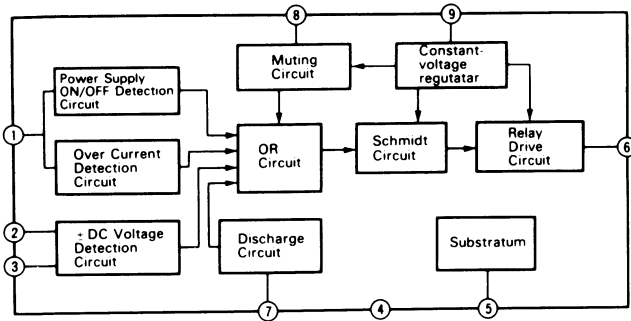

• M5219L <OP AMP>

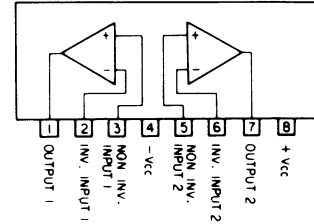

8. MAIN PARTS REPLACEMENT

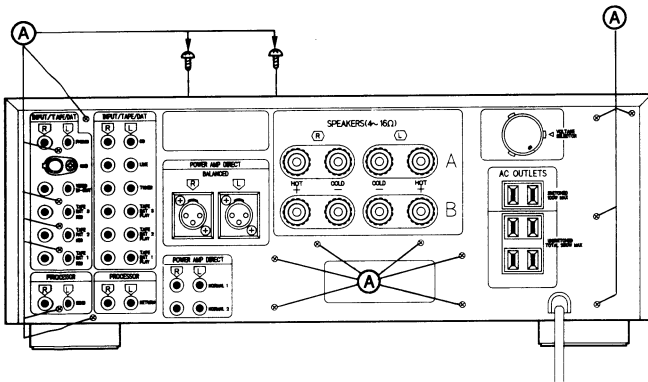

A. F-6160 Driver AMP Board

- 1) Remove the bonnet and base plate.
- 2) Remove the heat sinks from the bottom surface.
- 3) Remove the F-6160 driver amp board.

B. Front Panel Assembly

- 1) Remove the bonnet and base plate.
- 2) Remove the side cover.
- 3) Remove the knobs of VOLUME, SPEAKERS, BASS, TREBLE, BALANCE, SOURCE DIRECT, POWER AMP DIRECT and REC SELECTOR.
- 4) Remove the front panel assembly.
- 5) The front panel A assembly and B assembly are mounted with two screws.

***Caution:** Be sure not to lose the volume shaft ring. Install the panel after mounting the MM/MC knobs on the panel. Be sure that lead wires are not pinched.

C. Rear Panel

- 1) Remove the bonnet and base plate.
 - 2) Remove the 19 screws (A). (See figure left.)
 - 3) Remove the rear panel.
- * When installing, be sure that lead wires are not pinched.

9. PACKING LIST

Parts No.	Stock No.	Description
1	27608400	Vinyl Bag
2	27214900	Sheet
3	27417500	Protector Paper
4+5	27702020	Styrofoam Packing (Pair)
6	27809900	Carton Case

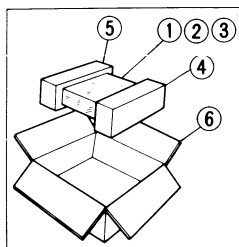

10. ACCESSORY LIST

Stock No.	Description
19057800	Operating Instructions (E.F.S)
19057900	Operating Instructions (G.I.Sw)

*NOTE

E.F.S: English, French and Spanish Version
G.I.Sw: German, Italian and Swedish Version

AU-X711



SANSUI ELECTRIC CO., LTD.:

SANSUI ELECTRONICS CORPORATION:

SANSUI ELECTRONICS G.M.B.H.:

山水電気株式会社

14-1, Izumi 2-chome, Suginami-ku, Tokyo 168 Japan
PHONE: (03) 324-8891 / TELEX: 232-2076 (International Division)
1250 Valley Brook Ave. Lyndhurst, N.J. 07071 U.S.A.
17150 South Margay Ave. Carson, California 90746 U.S.A.
Paul-Ehrlich-Strasse 8, 6074 Rödermark 2, West Germany

東京都杉並区和泉2-14-1(〒168)

(SM2-142) Printed in Japan (1989.08.C) <Stock No. 3654000>