

SERVICE MANUAL

INTEGRATED STEREO AMPLIFIER

SANSUI AU-X701/X901



CAUTION

1. Parts identified by the \triangle symbol on the schematic diagram and the parts list are critical for safety. Use only replacement parts that have critical characteristics recommended by the manufacturer.
2. Make leakage-current or resistance measurements to determine that exposed parts are acceptably insulated from the supply circuit before returning the appliance to the customer.

•SPECIFICATIONS

AU-X701

Power output

Min. RMS, both channels driven, from 20 to 20,000 Hz, with no more than 0.005% total harmonic distortion.

100 watts per channel into 8 ohms.

Load impedance..... 4 to 16 ohms

Total harmonic distortion

..... less than 0.005% at or below rated min. RMS power output

Intermodulation distortion

(60 Hz: 7 kHz = 4:1 SMPTE method)

..... less than 0.005% at rated power output

Frequency response (at 1 watt)

Overall (from CD)..... 1 to 300,000 Hz, +0 dB
-3 dB

RIAA curve deviation (PHONO-MM, 20 Hz to 20 kHz)

..... +0.2 dB, -0.2 dB

Input sensitivity and impedance (at 1 kHz)

PHONO (MC)..... 300 μ V/100 ohms

European models only

PHONO (MC TRANS)..... 160 μ V/16 ohms

PHONO (MM)..... 2.5 mV/47 kohms

(Max. input capability: 210 mV at 1 kHz, less than 0.01% total harmonic distortion)

CD, TUNER, LINE..... 150 mV/47 kohms

TAPE/DAT PLAY-1, 2, 3

..... 150 mV/47 kohms

PROCESSOR RETURN

..... 150 mV/47 kohms

Output level (1,000 Hz)

TAPE/DAT REC-1, 2, 3

..... 150 mV into 47 kohms

PROCESSOR SEND..... 150 mV into 47 kohms

Signal to noise ratio (short-circuit, A-network)

PHONO (MM)..... 88 dB

CD, TUNER, LINE..... 110 dB

TAPE/DAT PLAY-1, 2, 3

..... 110 dB

Controls and Filter

BASS..... \pm 5 dB at 50 Hz

TREBLE..... \pm 5 dB at 15 kHz

SUBSONIC..... -3 dB at 16 Hz (6 dB/oct)

MUTING..... -20 dB

LOUDNESS..... +8 dB at 50 Hz

+6 dB at 10 kHz

(VOLUME: -30 dB position)

Power requirements..... AC 120V/220V/240V,
50/60 Hz

For U.S.A. & Canada... AC 120V, 60 Hz

Power consumption..... 380 watts 460 VA Rated
720 watts Maximum

Dimensions..... 448 mm (17-11/16") W
160 mm (6-9/16") H
441 mm (17-3/8") D

Weight..... 17.1 kg (37.7 lbs) net
19 kg (41.9 lbs) packed

to be continued ►

Sansui

SANSUI ELECTRIC CO., LTD.

1. BLOCK DIAGRAM

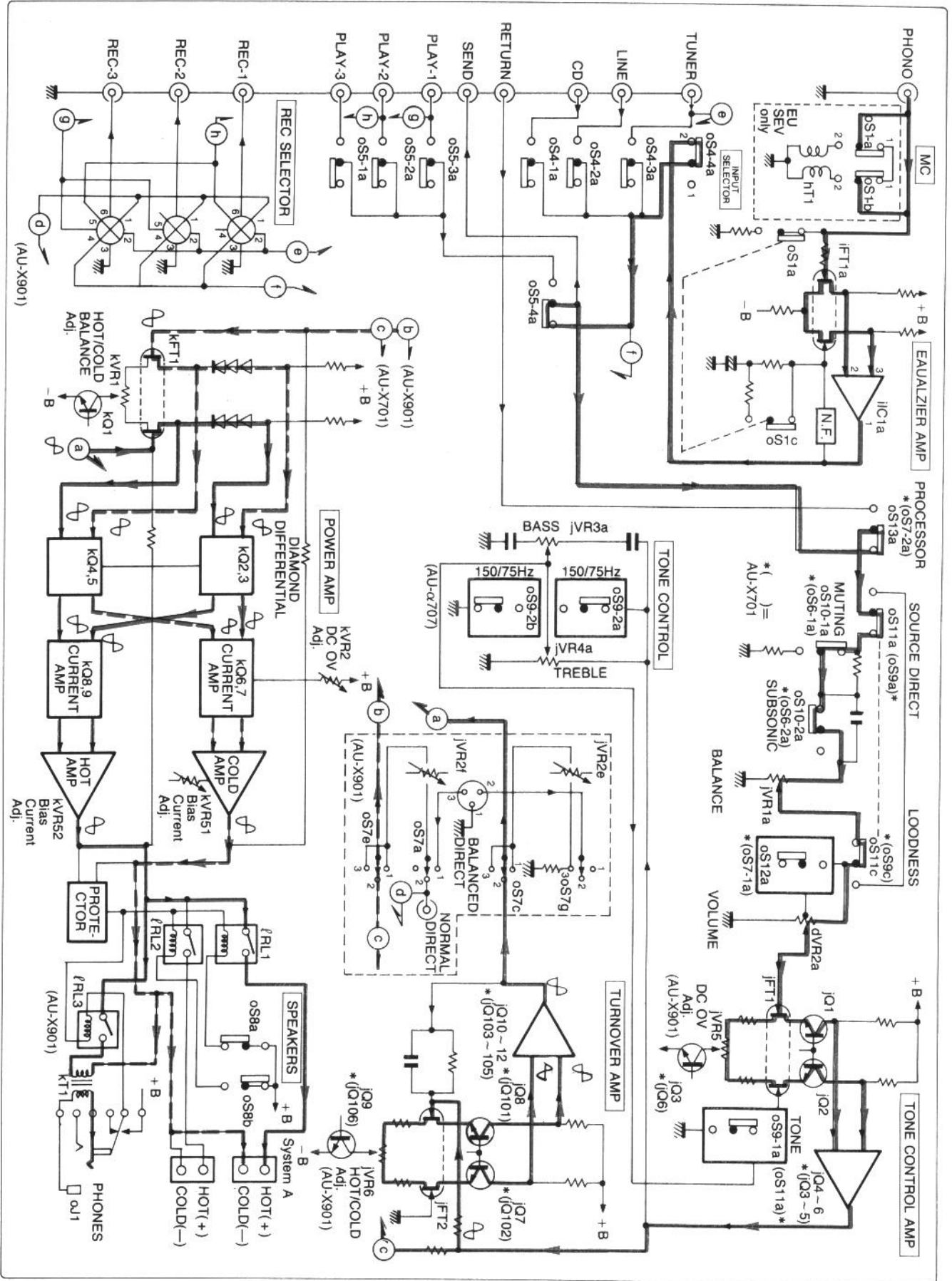

4. PARTS LOCATION ON BOARD

4-1. F-5628 EQ Amp & Input Terminal Board <AU-X701>

Pattern Side

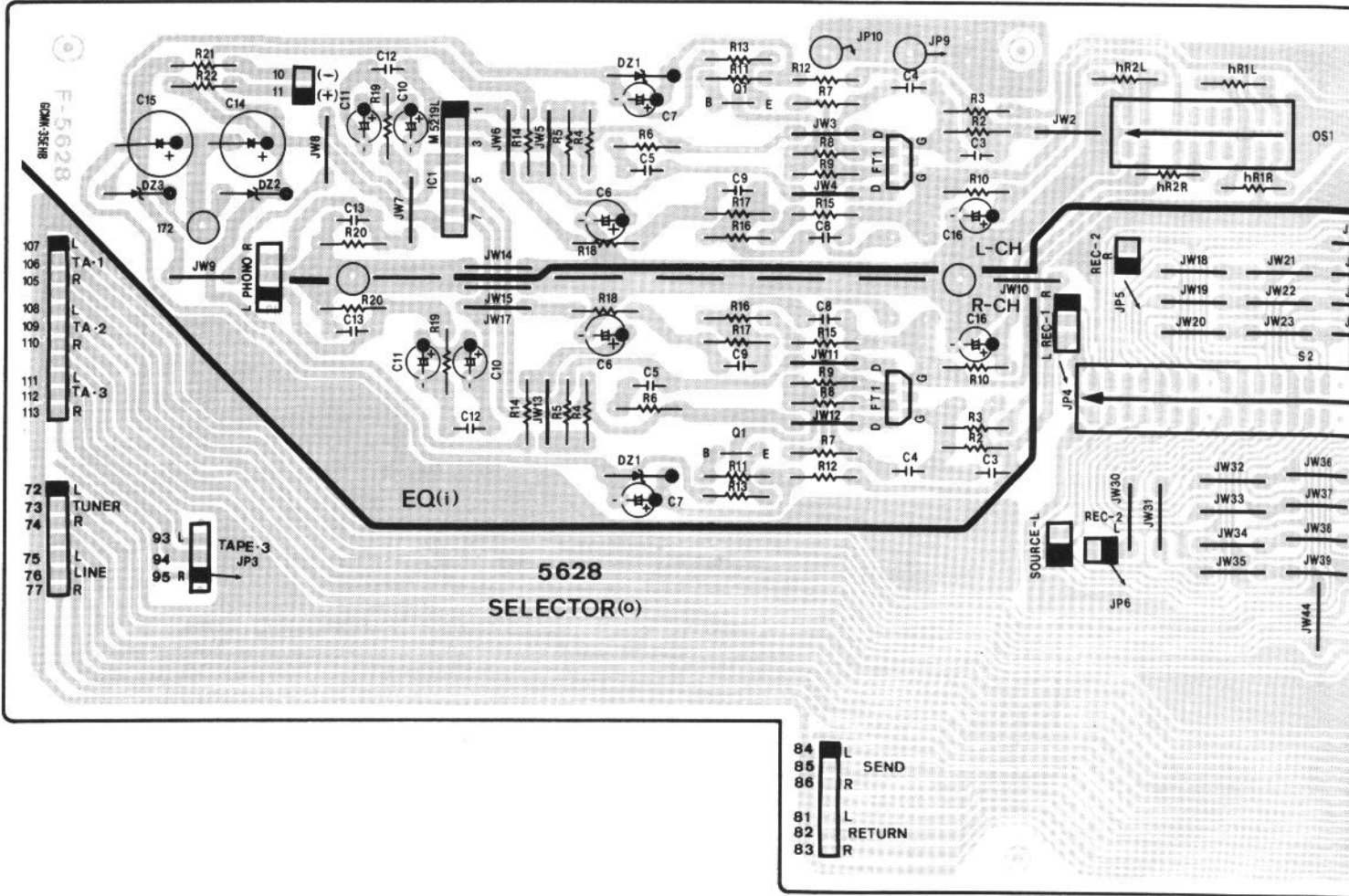

4-3. F-5691 Tape Terminal Board <AU-X701-EU·SEV/AU-X901-XX·UL·EU·SEV·CSA>

Component Side

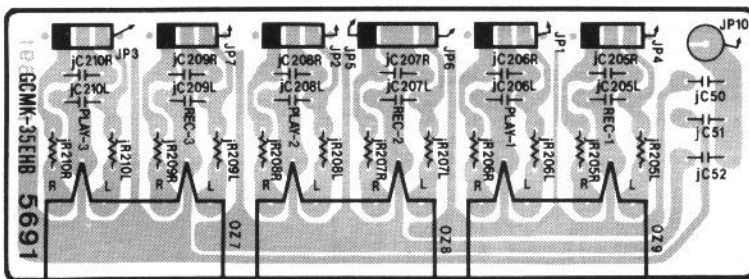

4-4. F-5692 Power Amp Direct

Component Side

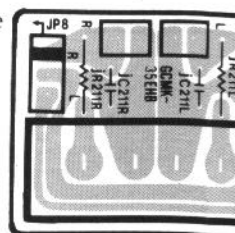

4-5. F-5694 L-CH Power Limiter Board

Component Side

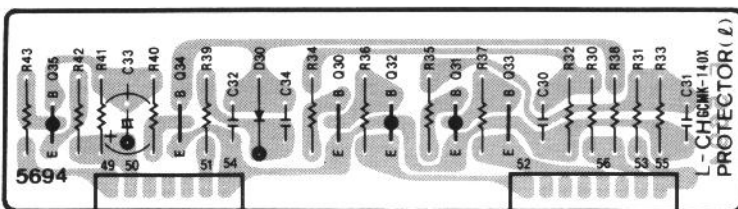

4-6. F-5695 R-CH Power Limite

Component Side

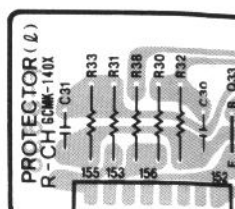

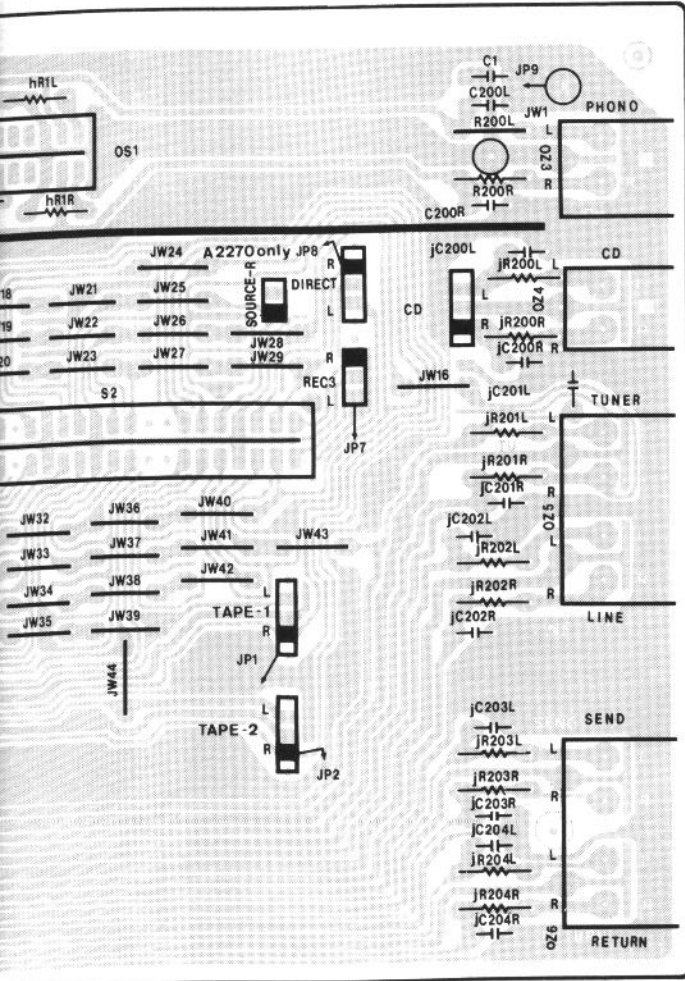

Amp Direct Terminal Board <AU-X901>

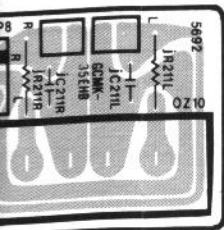

Power Limiter Board

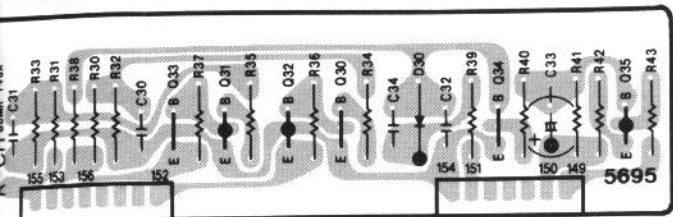

4-2. F-5631 Power Supply Board

Component Side

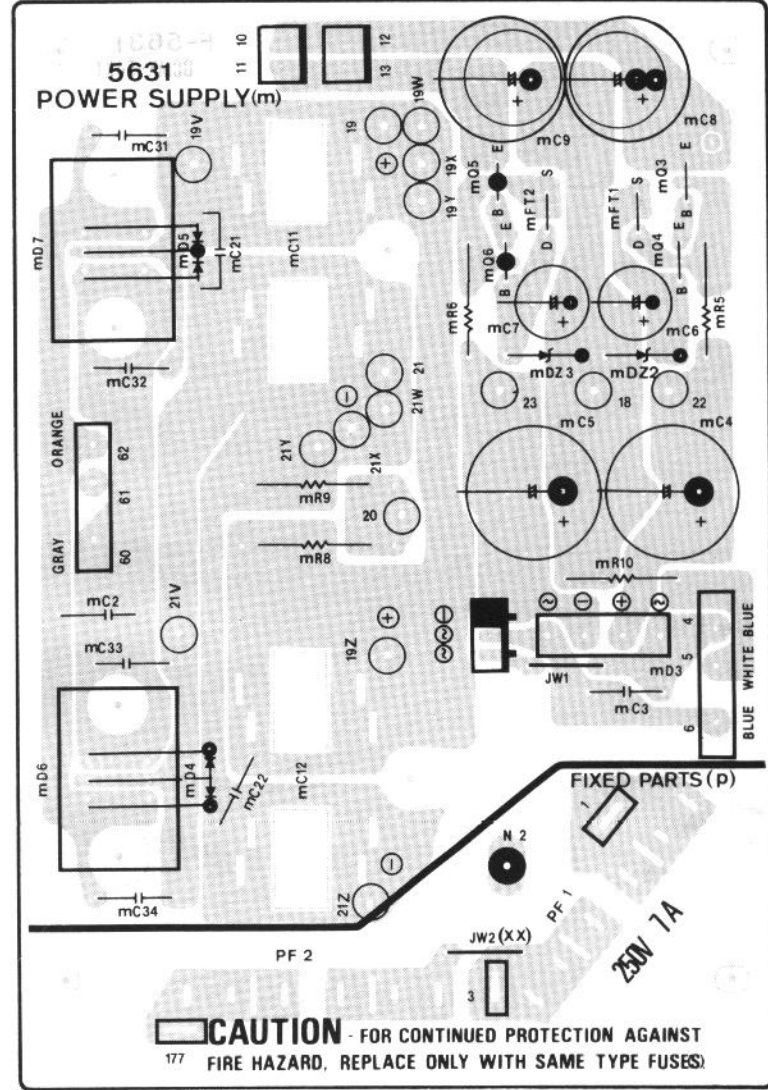

4-7. F-5629 Tape Terminal Board <AU-X701-XX-UL-CSA>

Component Side

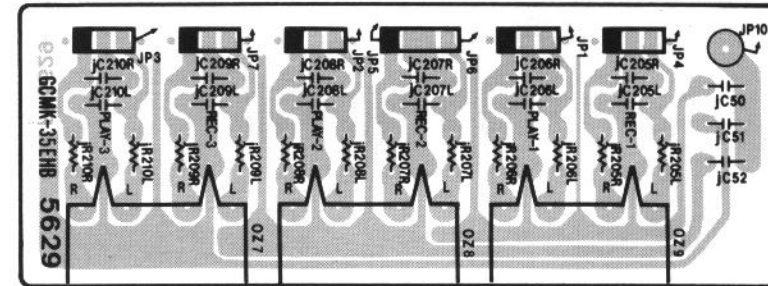

4-8. F-5642 AC Outlet Board (EU, SEV)

Component Side

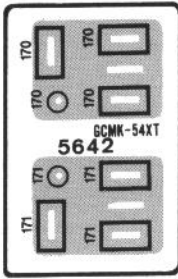

4-9. F-5690 EQ Amp & Input Terminal Board <AU-X901/AU-X701-EU>

Pattern Side

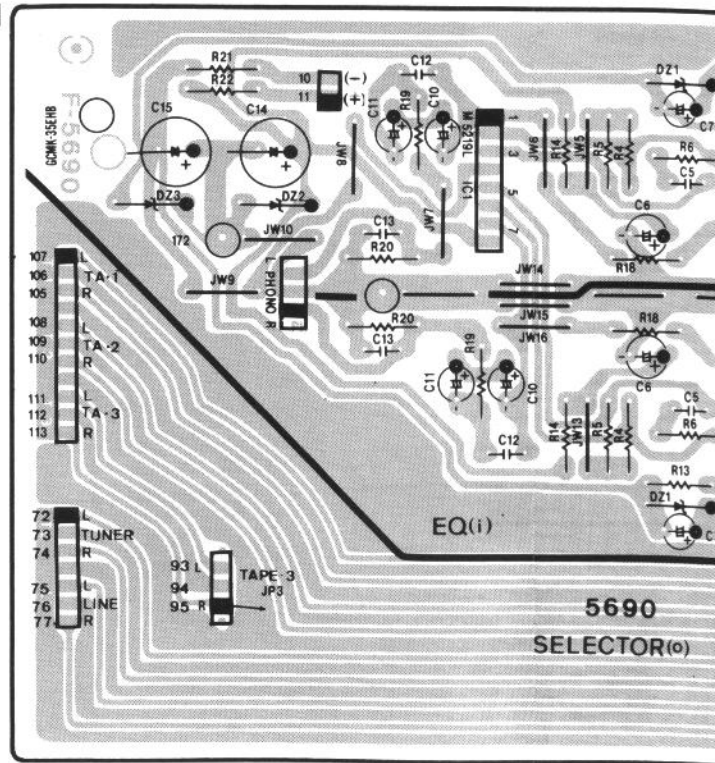

4-10. F-5635 Tone Control Amp Board <AU-X701>

Component Side

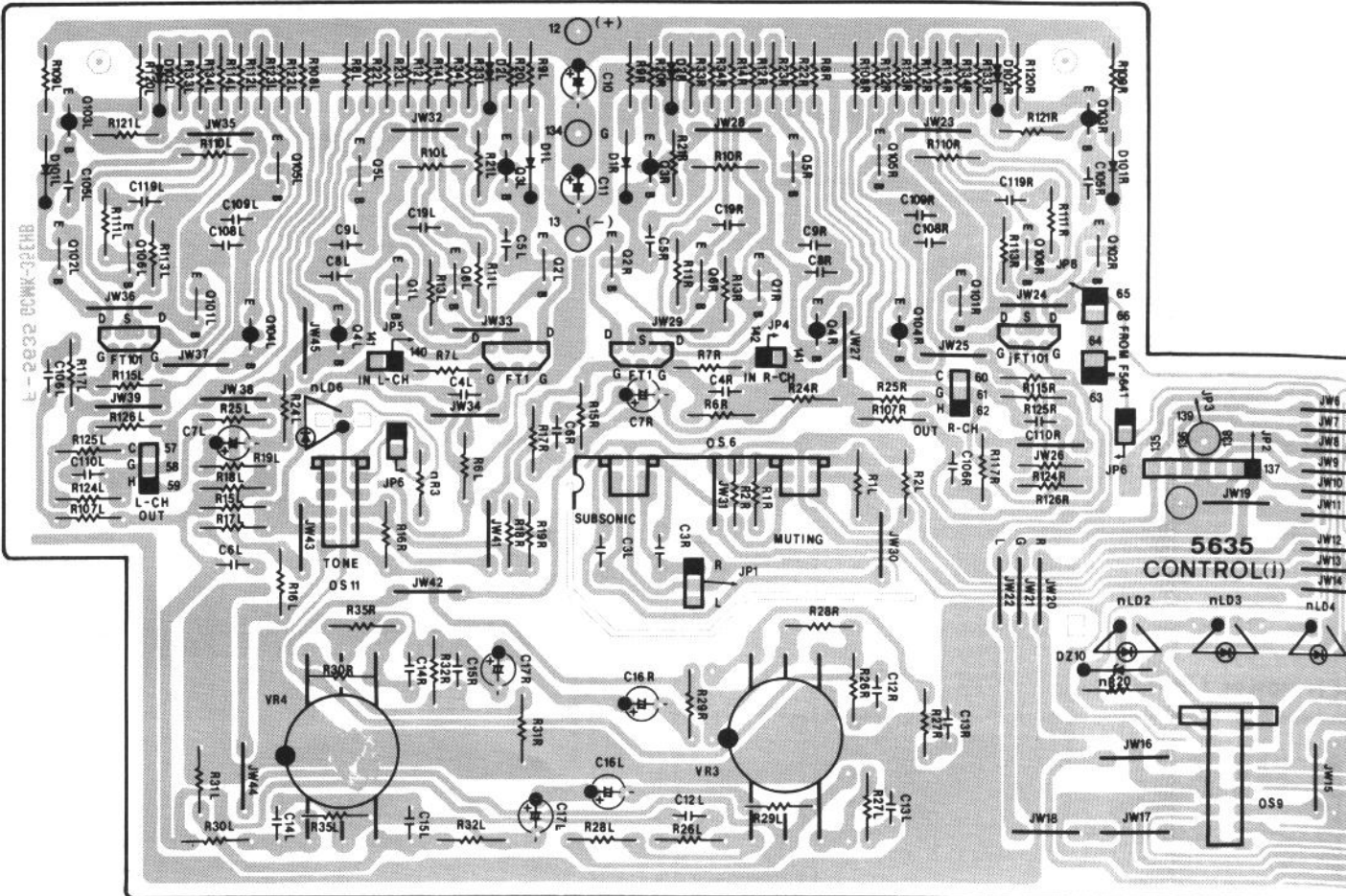

J-X901/AU-X701-EU-SEV >

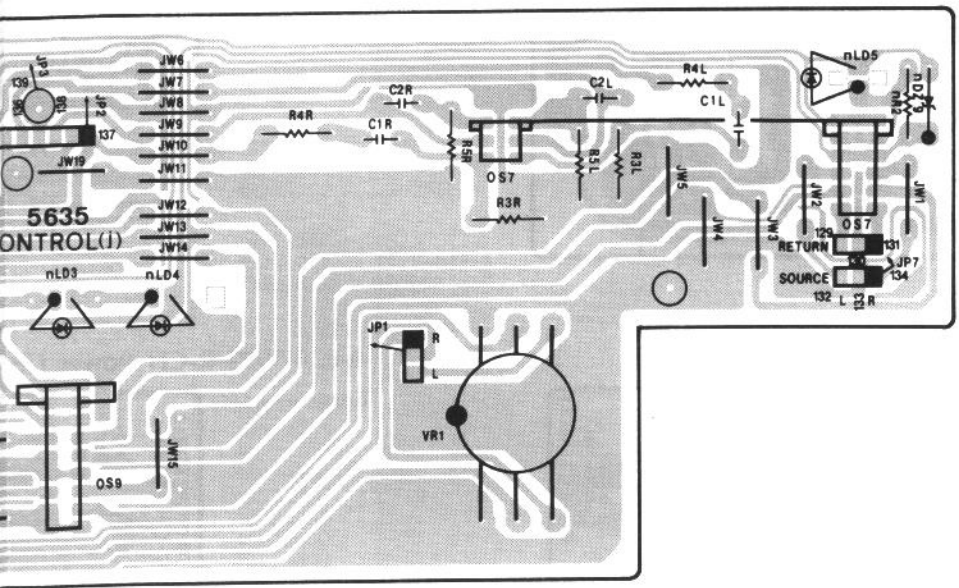
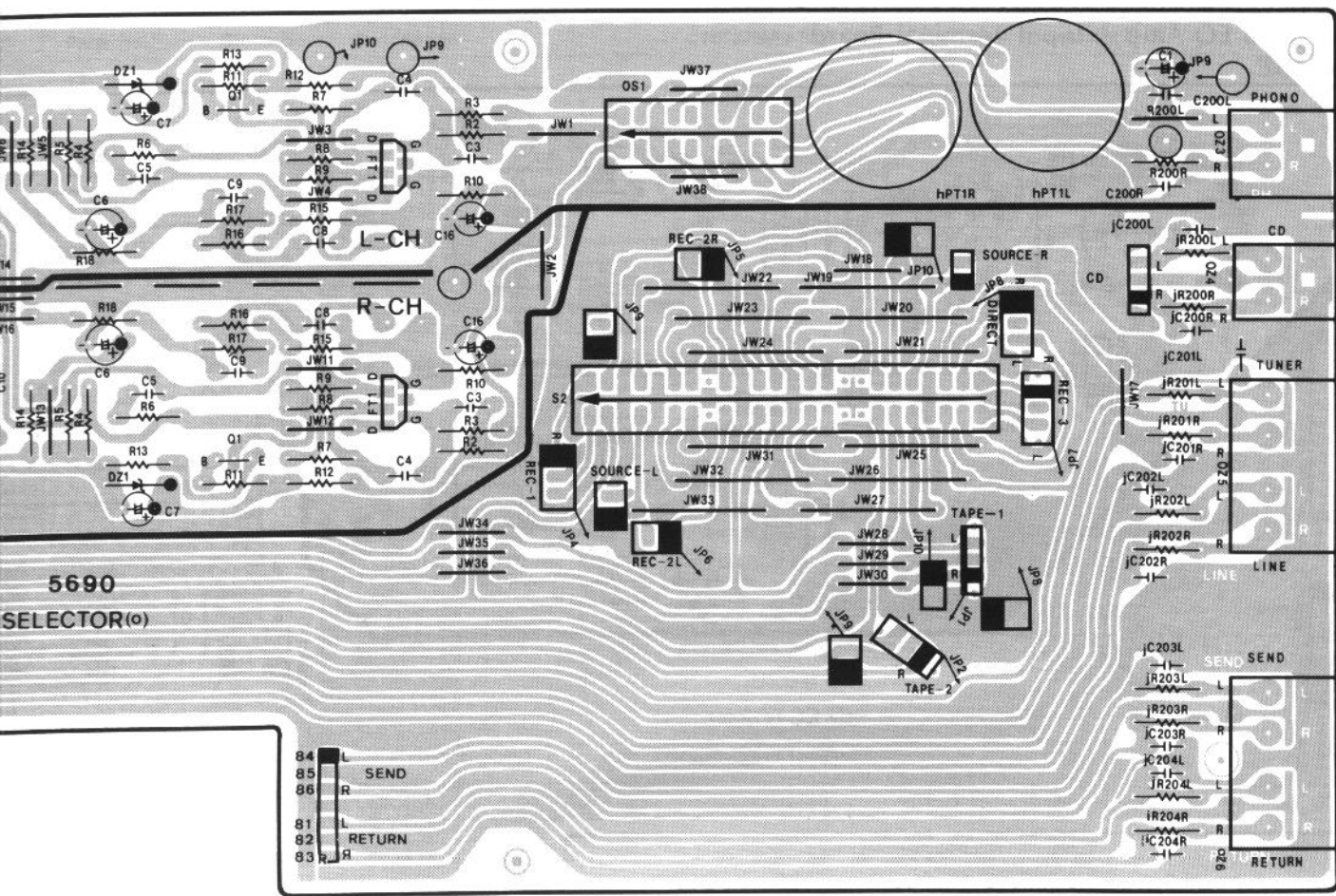

4-11. F-5643 Tone Control Amp Board <AU-X901>

Component Side

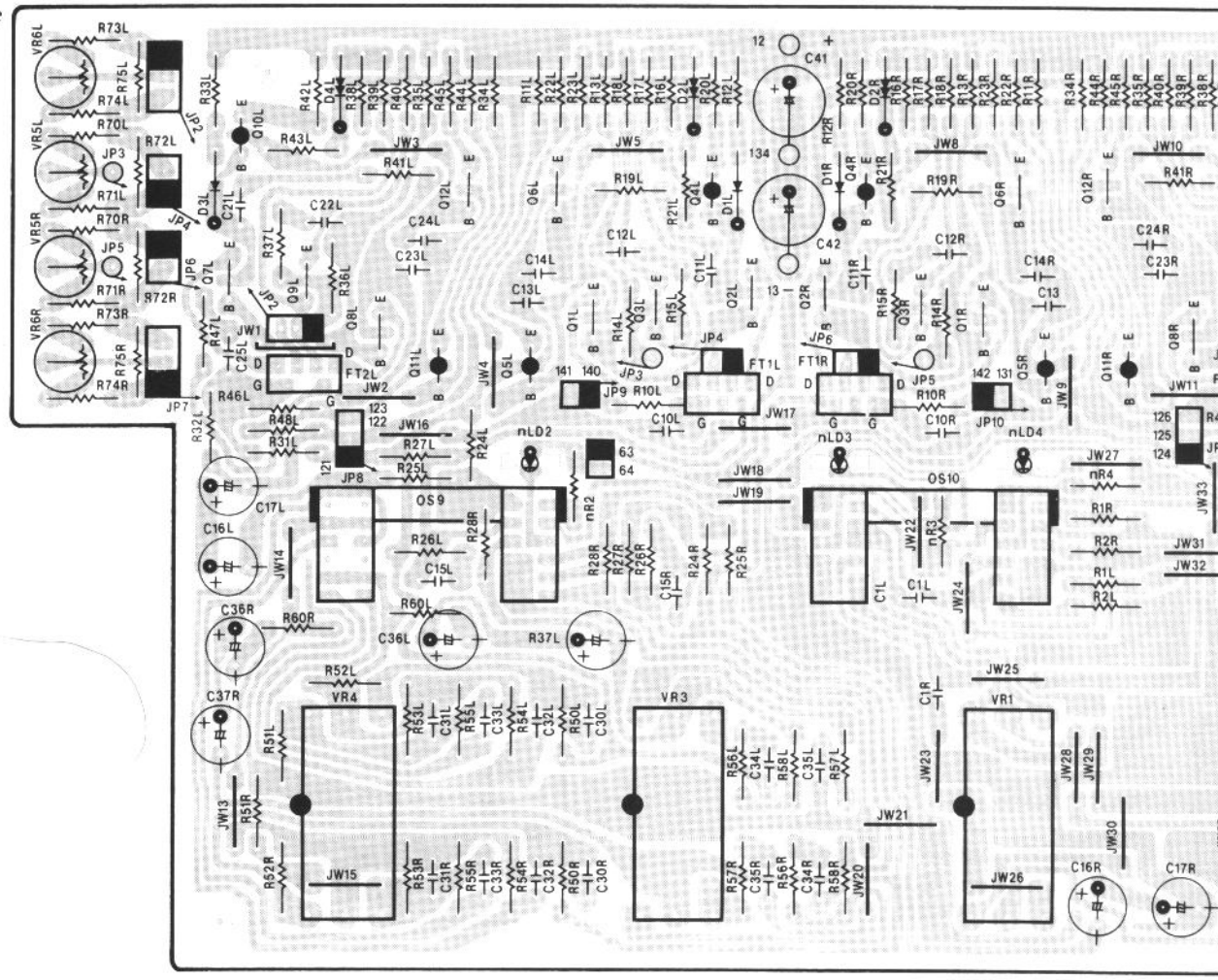

4-13. F-5640 Head Phones Board

Component Side

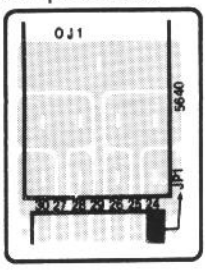

4-15. F-5641 SP SW. Board

Component Side

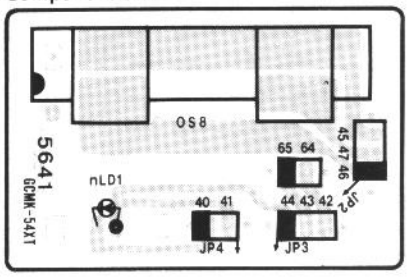

4-14. F-5645 Input Selector Board <AU-X901>

Component Side

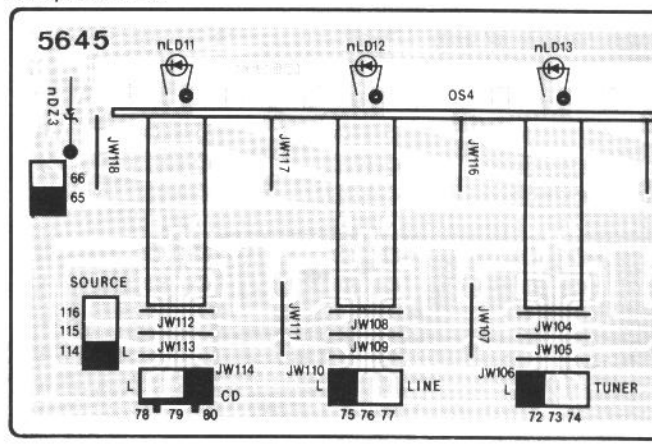

4-12. F-5644 Volume Board <AU-X901>

Component Side

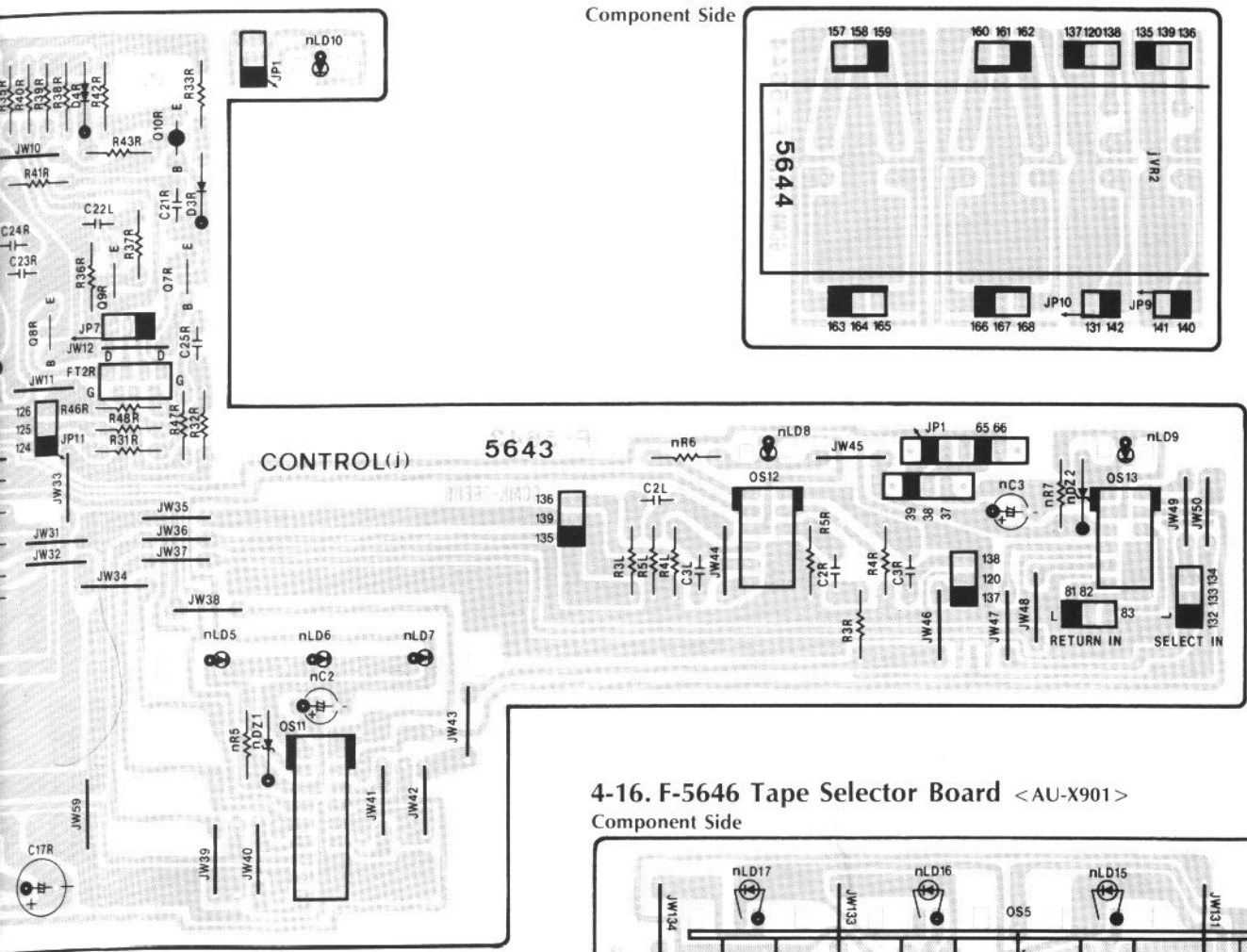

4-16. F-5646 Tape Selector Board <AU-X901>

Component Side

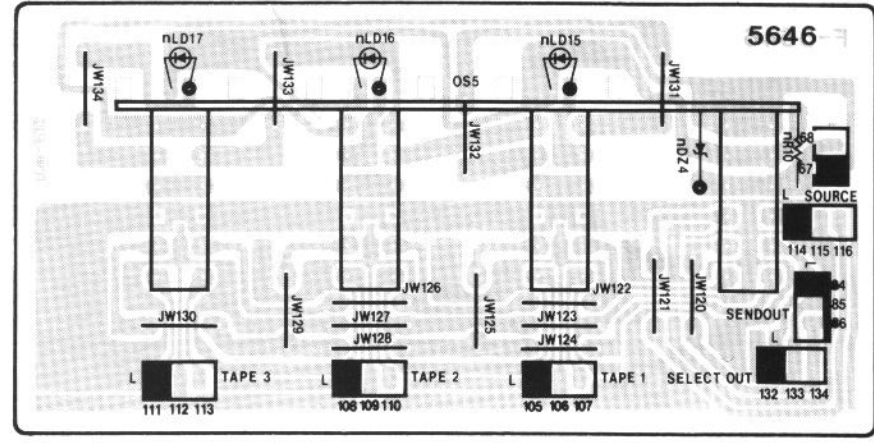

4-17. F-5647 Power Amp Direct SW. Board <AU-X901>

Component Side

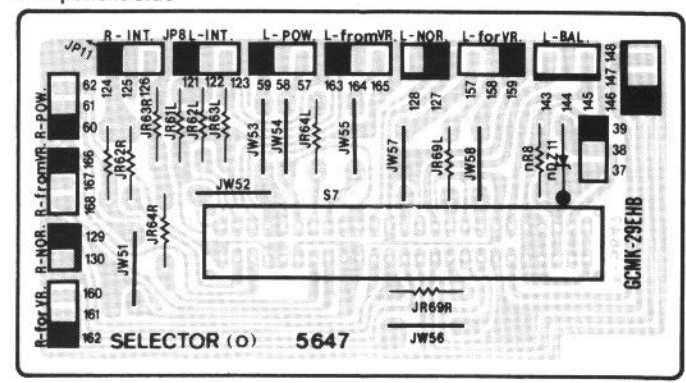

4-18. F-5693 Power Amp Board

Component Side

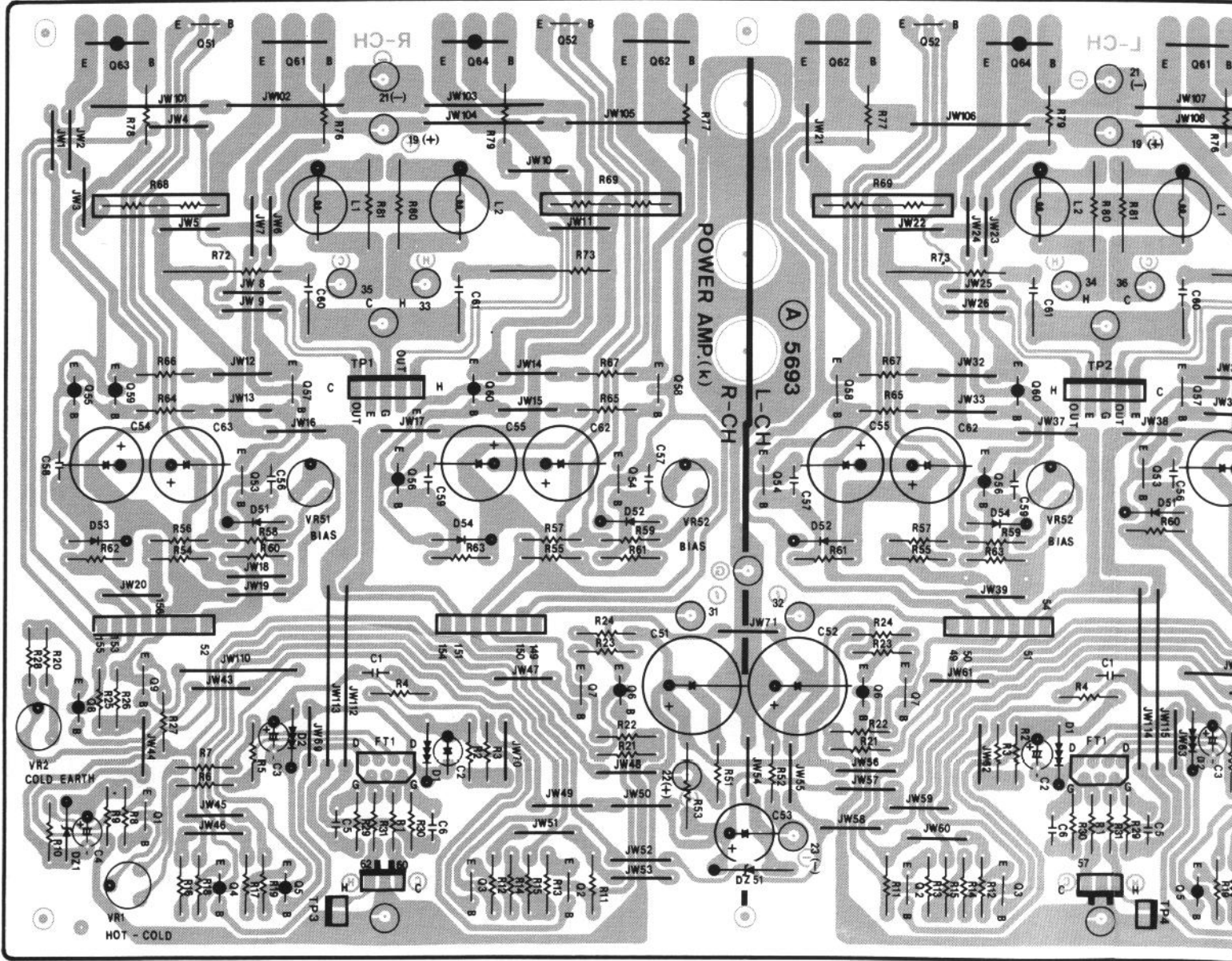

4-20. F-5637 Input Selector Board <AU-X701>

Component Side

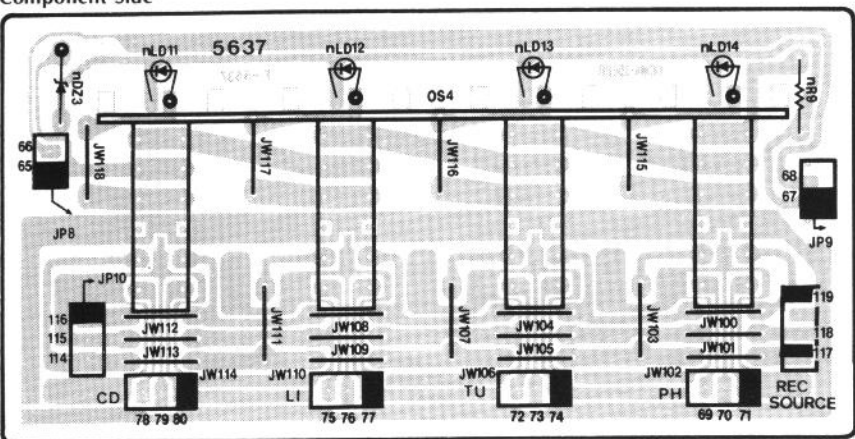

4-21. F-5638 Tape Selector Board <AU-X701>

Component Side

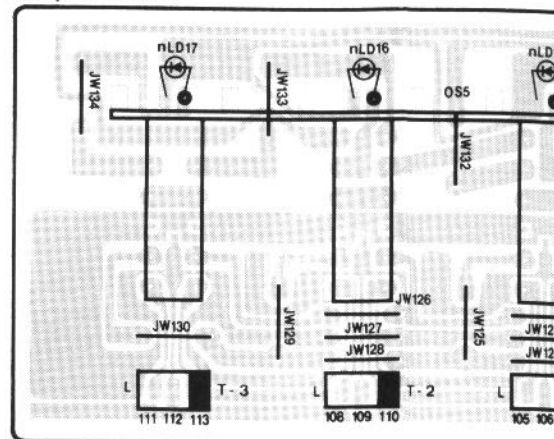

4-19. F-5639 Protector Board

Pattern Side

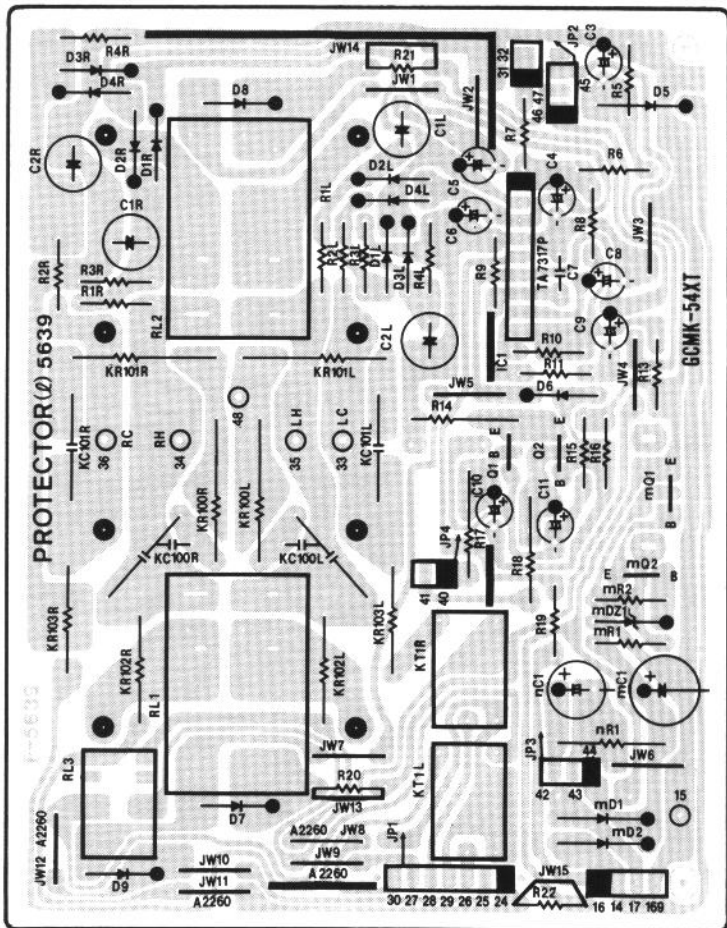
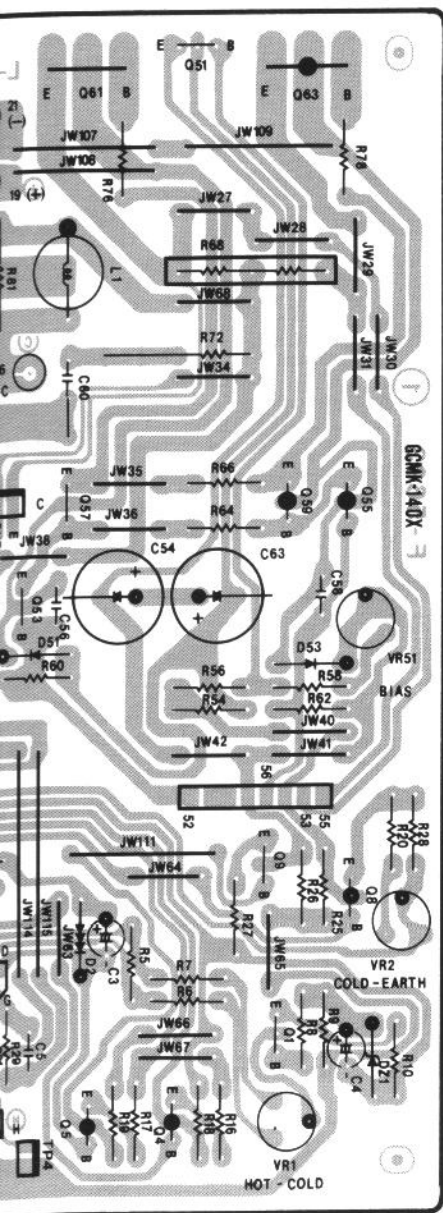

ard <AU-X701>

4-22. F-5636 Volume Board <AU-X701>

Component Side

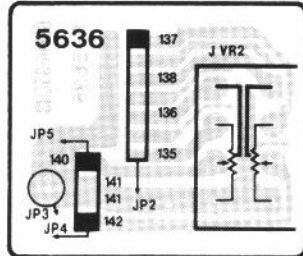
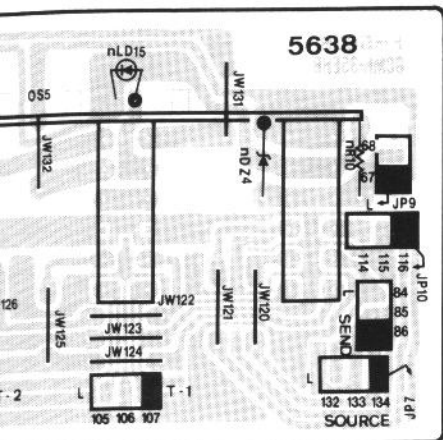

* Design and specifications subject to change without notice for improvement.
 * La présentation et les spécifications sont susceptibles d'être modifiées sans préavis par suites d'améliorations éventuelles.
 * Änderungen, die dem technischen Fortschritt dienen, bleiben vorbehalten.

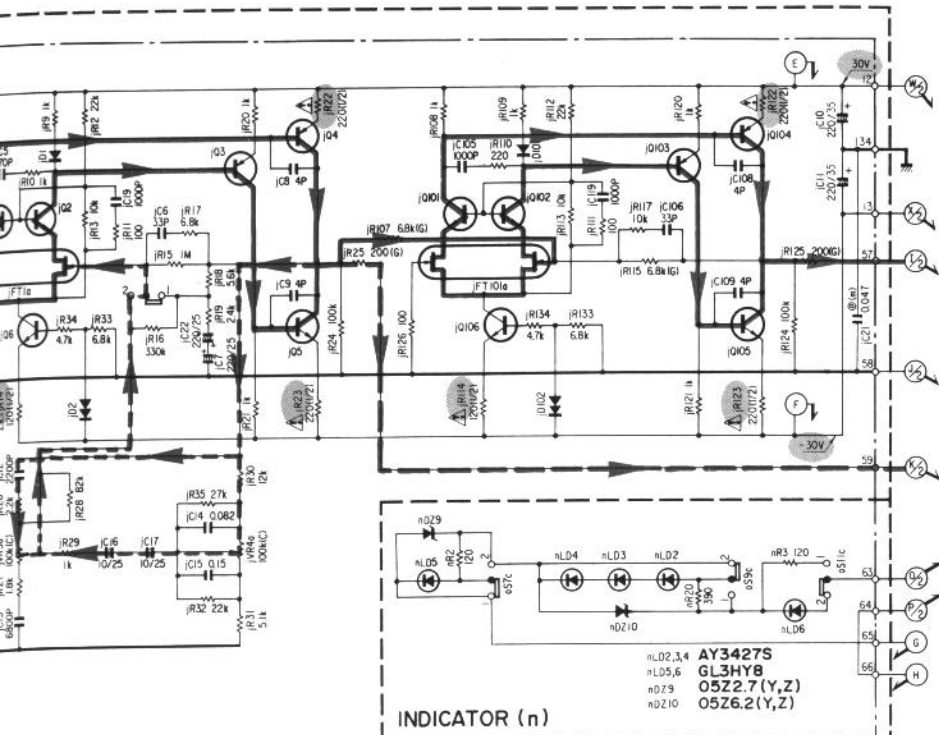

INDICATOR (n)

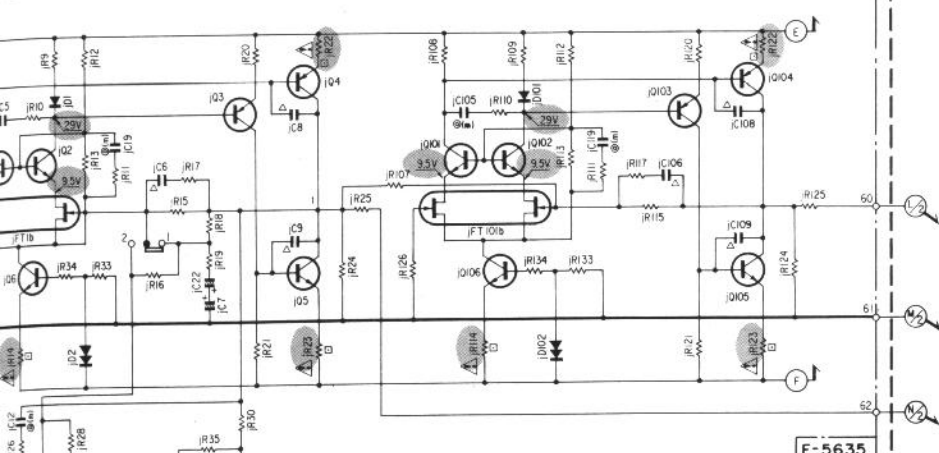

SYMBOL OF FUNCTION

- (h) MC
- (i) EQ
- (j) CONTROL
- (k) POWER AMP
- (l) PROTECTOR
- (m) POWER SUPPLY
- (n) INDICATOR
- (o) SELECTOR
- (p) FIXED PARTS

- SYMBOL
- △ Ceramic
 - ⊖/m Mylar
 - ⊖ Polystyrene
 - ⊖/p Polypropylene film
 - ⊖ Non-inflammable Resistor

⚠ is Safety Part.
 Use only replacement parts recommended by the manufacturer.

RESISTORS
 Are in ohms, 1/4 Watts, 1.5% Tolerance Unless otherwise Noted as kΩ, M, MΩ

TOLERANCE
 G ± 2%

CAPACITORS
 Are in μF, Unless otherwise Noted p, pF

ELECTROLYTIC CAPACITOR
 Capacitance (μF / Volt/V)

- SWITCHES
- o51 CARTRIDGE SELECTOR
 - 1 MM
 - 2 MC
 - o52 REC SELECTOR
 - 1 TUNER
 - 2 OFF
 - 3 SOURCE
 - 4 1 → 2,3
 - 5 2 → 1,3
 - o54 LINE SELECTOR
 - 1 CD
 - 2 LINE
 - 3 TUNER
 - 4 PHONO
 - o55 TAPE SELECTOR
 - 1 TAPE 3
 - 2 TAPE 2
 - 3 TAPE 1
 - 4 TAPE / LINE
 - o56-1 MUTING
 - 1 OFF 2 ON
 - o56-2 SUBSONIC
 - 1 OFF 2 ON
 - o57-1 LOUDNESS
 - 1 OFF 2 ON
 - o57-2 PROCESSOR
 - 1 SOURCE
 - 2 RETURN
 - o59 SOURCE DIRECT
 - 1 OFF 2 ON
 - o511 TONE
 - 1 OFF 2 ON

- 2SA982
- 2SA1049
- 2SA1145
- 2SC1815
- 2SC1845
- 2SC2705
- 2SD357
- 2SA1438
- 2SC3851
- 2SA1115
- 2SC2459
- 2SC2603
- 2SK163
- 2SA1386
- 2SC3519
- 2SK389
- 2SA1306
- 2SC3298
- TA7317P
- M5219L
- FMG-22S
- UB-152LFF
- FMG-22R
- 1S1588
- 1S2091
- 1S2473D
- 10E2
- 11E2
- MV12
- MV103
- 05Z2.7
- 05Z6.2
- 05Z7.5
- 05Z20
- 05Z24
- 05Z33
- RD6.2E
- RD22F

1
2
3
4
5

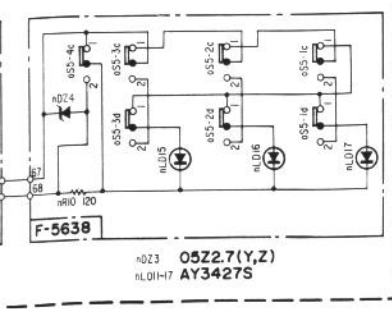
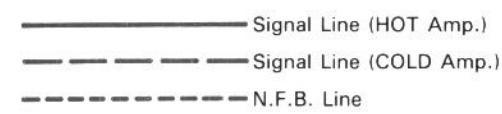

nD23 05Z2.7(Y,Z)
 nD1-H7 AY3427S

F-5635

E

F

G

H

* Design and specifications subject to change without notice for improvement.
 * La présentation et les spécifications sont susceptibles d'être modifiées sans préavis par suites d'améliorations éventuelles.
 * Änderungen, die dem technischen Fortschritt dienen, bleiben vorbehalten.

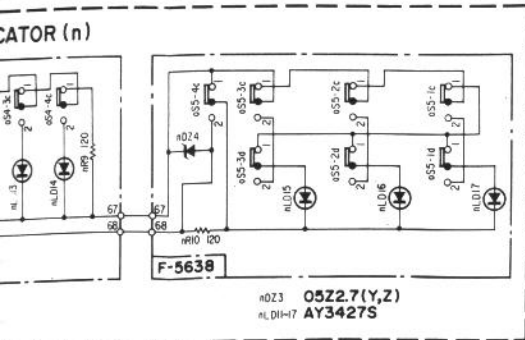
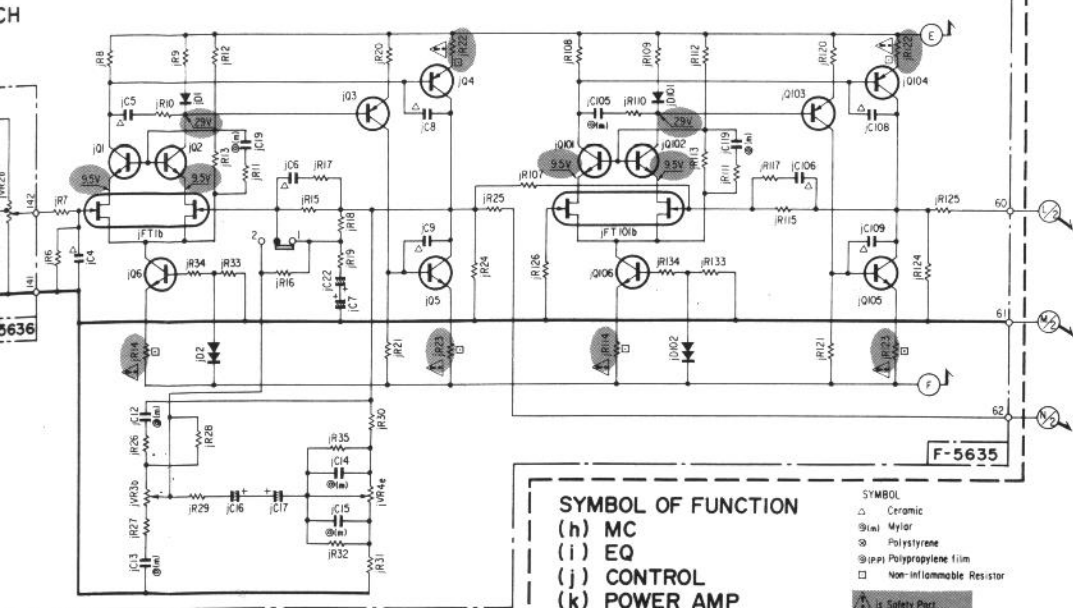
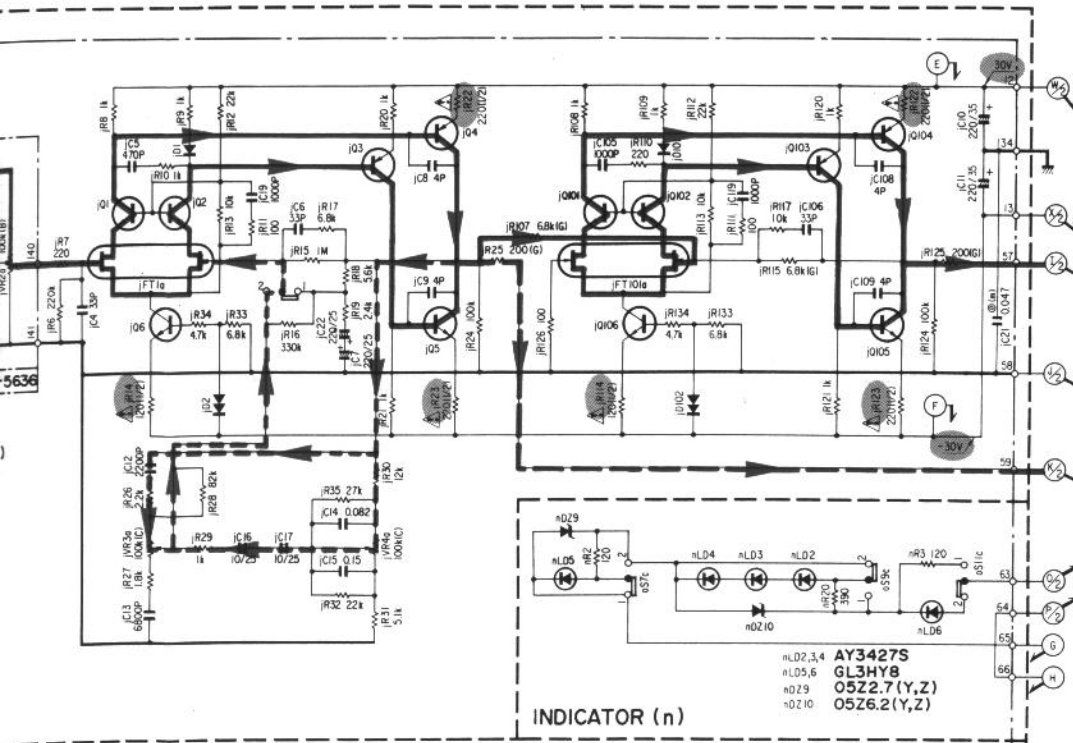

INDICATOR (n)

SYMBOL OF FUNCTION

- (h) MC
- (i) EQ
- (j) CONTROL
- (k) POWER AMP
- (l) PROTECTOR
- (m) POWER SUPPLY
- (n) INDICATOR
- (o) SELECTOR
- (p) FIXED PARTS

- SYMBOL**
- Ceramic
 - ⊗ Mylar
 - ⊙ Polystyrene
 - ⊕ Polypropylene film
 - Non-Flammable Resistor
- ⚠ Safety Part**
 Use only replacement parts recommended by the manufacturer.
- RESISTORS**
 Are in ohms, 1/4 Watts, ±5% Tolerance Unless otherwise noted. k, M, MG
- TOLERANCE**
 ± 2%
- CAPACITORS**
 Are in µF, Unless otherwise noted. P, pF
- ELECTROLYTIC CAPACITOR**
 Capacitance (µF) / Volt (V)



- 2SA992
- 2SA1049
- 2SA1145
- 2SC1815
- 2SC1845
- 2SC2705
- 2SD357
- 2SA1115
- 2SC2459
- 2SC2603
- 2SA1438
- 2SC3851
- 2SK163
- 2SA1386
- 2SC3519
- 2SK389
- 2SA1306
- 2SC3298
- TA7317P
- M5219L
- FMG-22S
- UB-152LFF
- FMG-22R
- 1S1588
- 1S2091
- 1S2473D
- 10E2
- MV12
- MV103
- 05Z2.7
- 05Z6.2
- 05Z7.5
- 05Z20
- 05Z24
- 05Z33
- RD6.2E
- RD22F

- SWITCHES**
- 051 CARTRIDGE SELECTOR
 - 1 MM
 - 2 MC
 - 052 REC SELECTOR
 - 1 TUNER
 - 2 OFF
 - 4 1=SOURCE
 - 5 2=1,3
 - 054 LINE SELECTOR
 - 1 CD
 - 2 LINE
 - 3 TUNER
 - 4 PHONO
 - 055 TAPE SELECTOR
 - 1 TAPE 3
 - 2 TAPE 2
 - 3 TAPE 1
 - 4 TAPE /LINE
 - 056-1 MUTING
 - 1 OFF 2 ON
 - 056-2 SUBSONIC
 - 1 OFF 2 ON
 - 057-1 LOUDNESS
 - 1 OFF 2 ON
 - 057-2 PROCESSOR
 - 1 SOURCE
 - 2 RETURN
 - 059 SOURCE DIRECT
 - 1 OFF 2 ON
 - 0511 TONE
 - 1 OFF 2 ON

* FT2 MODEL only

1

2

3

4

5

A

B

C

D

6-3. Power Amp & Power Section <AU-X701>

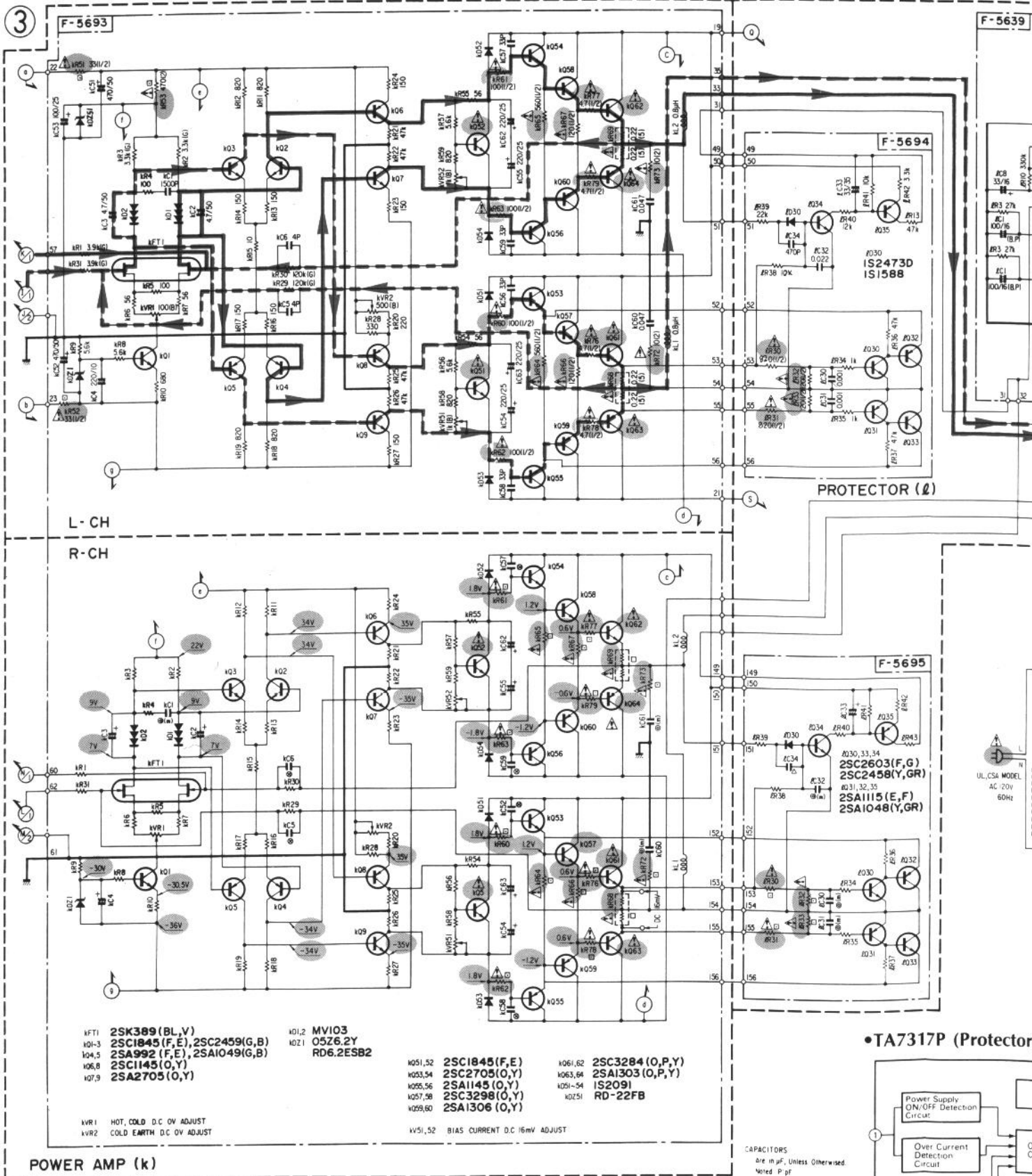

F-5693

F-5639

F-5694

F-5695

L-CH

R-CH

PROTECTOR (l)

- KFT1 2SK389 (BL,V)
- K01-3 2SC1845 (F,E), 2SC2459 (G,B)
- K04,5 2SA992 (F,E), 2SA1049 (G,B)
- K06,8 2SC1145 (O,Y)
- K07,9 2SA2705 (O,Y)
- K01,2 MV103
- K02,1 05Z6.2Y
- RD6.2ESB2

- K051,52 2SC1845 (F,E)
- K053,54 2SC2705 (O,Y)
- K055,56 2SA1145 (O,Y)
- K057,58 2SC3298 (O,Y)
- K059,60 2SA1306 (O,Y)
- K061,62 2SC3284 (O,P,Y)
- K063,64 2SA1303 (O,P,Y)
- K051-54 IS2091
- K0251 RD-22FB

KWR1 HOT, COLD D.C. OV ADJUST
KWR2 COLD EARTH D.C. OV ADJUST

KV51,52 BIAS CURRENT D.C. 16mV ADJUST

SYMBOL OF FUNCTION (n) INDICATOR
(l) PROTECTOR (o) SELECTOR
(m) POWER SUPPLY (p) FIXED PARTS

SYMBOL
 △ Ceramic Capacitor
 (M) Mylar
 ⊕ Polystyrene
 □ Non-inflammable Resistor
 □ Cement Resistor

SWITCHES
 ○SB-a SPEAKER-A
 | OFF 2 ON
 ○SB-b SPEAKER-B
 | OFF 2 ON

RESISTORS
 Are in ohms, 1/4 Watts, ±5%
 Tolerance Unless Otherwise
 Noted x k, M, MΩ

CAPACITORS
 Are in μF, Unless Otherwise
 Noted P pF

ELECTROLYTIC CAPACITANCE
 Capacitance (μF/volt/v)

TOLERANCE
 ± 2%

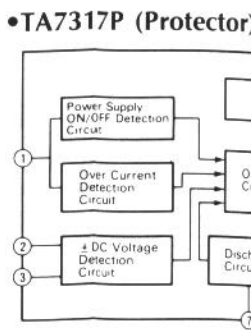

6-4. EQ Amp & Control Amp Section <AU-X901>

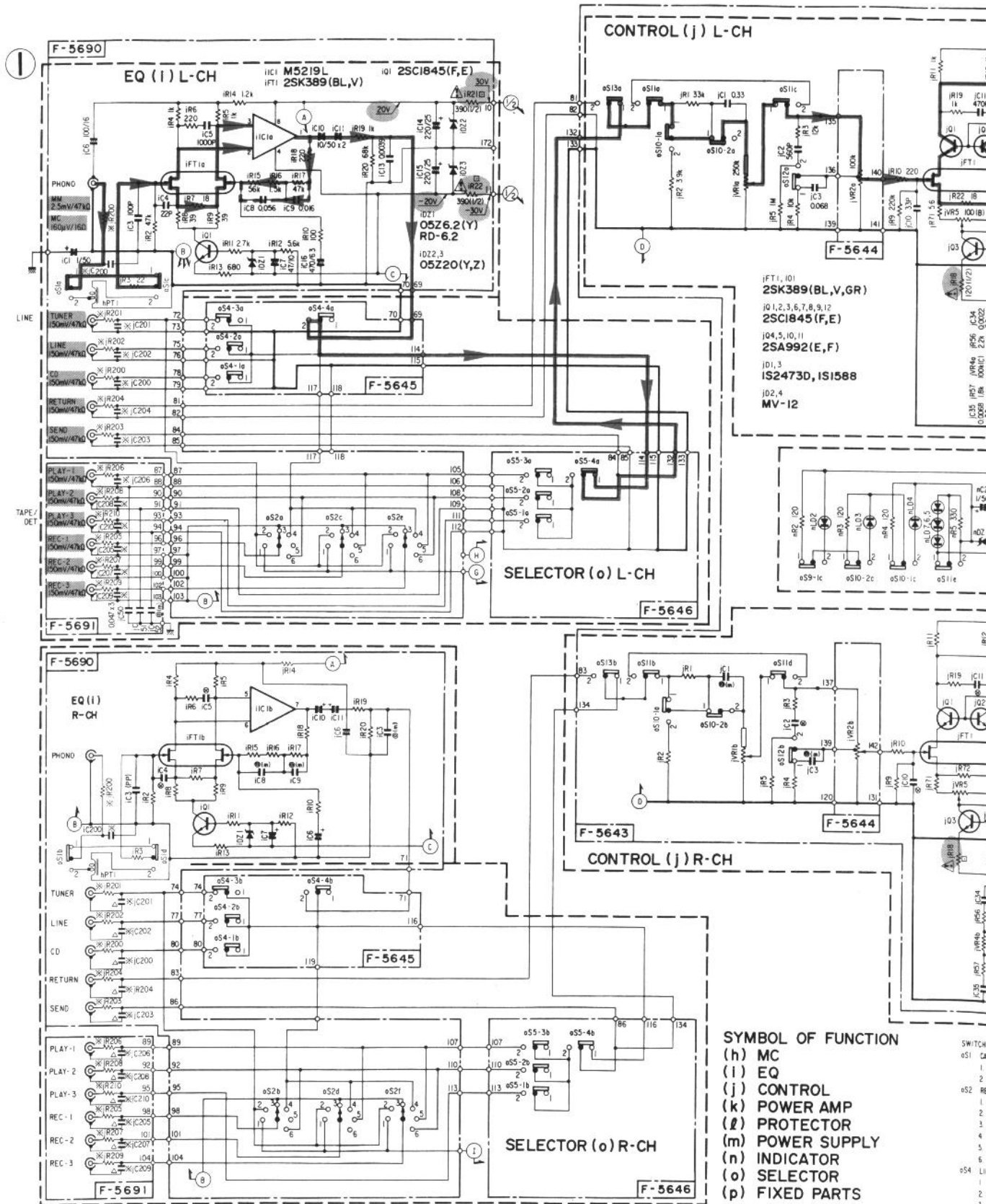

* Design and specifications subject to change without notice for improvement.
 * La présentation et les spécifications sont susceptibles d'être modifiées sans préavis par suites d'améliorations éventuelles.
 * Änderungen, die dem technischen Fortschritt dienen, bleiben vorbehalten.

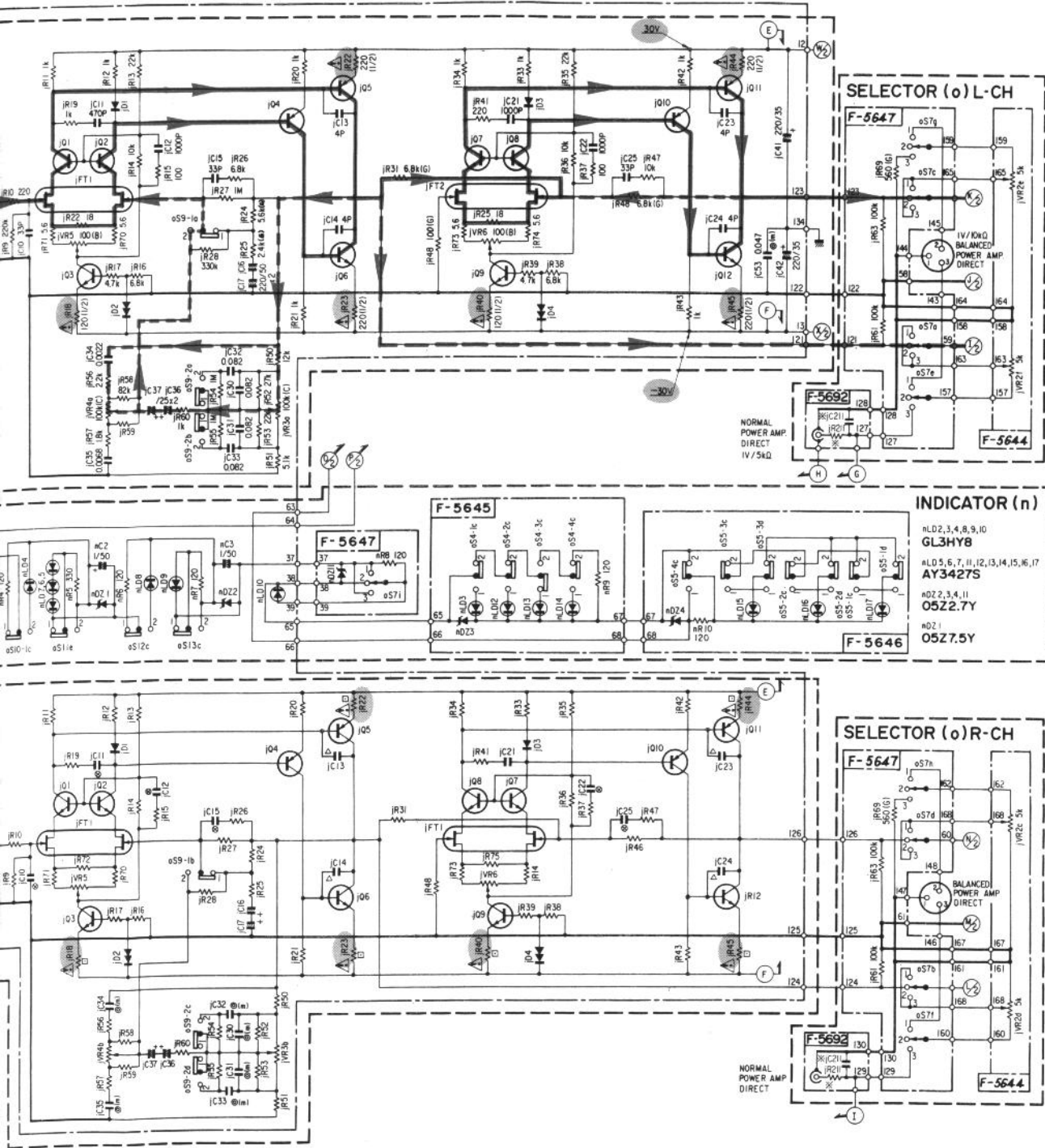

- 2SA992
- 2SA1049
- 2SA1145
- 2SC1815
- 2SC1845
- 2SC2705

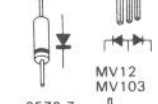
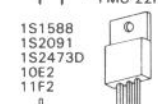
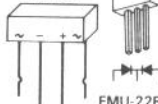
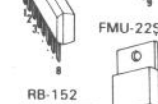
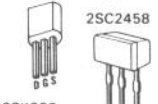
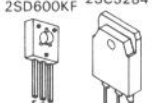
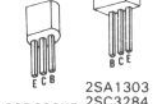

1

2

3

4

5

- SWITCHES**
- oS1 CARTRIDGE SELECTOR
 - 1 MM
 - 2 MC
 - oS2 REC SELECTOR
 - 1 DIRECT (NORMAL)
 - 2 TUNER
 - 3 OFF
 - 4 SOURCE
 - 5 1-2,3
 - 6 2-1,3
 - oS4 LINE SELECTOR
 - 1 CD
 - 2 LINE
 - 3 TUNER
 - 4 PHONO
 - oS5 TAPE SELECTOR
 - 1 TAPE 3
 - 2 TAPE 2
 - 3 TAPE 1
 - 4 TAPE / LINE
 - oS7 POWER AMP DIRECT OPERATION
 - 1 BALANCED
 - 2 INTEGRATED
 - 3 NORMAL
 - oS9-1 TONE
 - 1 OFF 2 ON
 - oS9-2 TURNOVER
 - 1 75Hz 2 150Hz

- oS10-1 MUTING
 - 1 OFF 2 ON
- oS10-2 SUBSONIC
 - 1 OFF 2 ON
- oS11 SOURCE DIRECT
 - 1 OFF 2 ON
- oS12 LOUDNESS
 - 1 OFF 2 ON
- oS13 PROCESSOR
 - 1 OFF 2 ON

- SYMBOL**
- △ Ceramic
 - Mylor
 - Polystyrene
 - ⊖ Polypropylene film
 - Non-Inductive Resistor
- ⚠ Safety Part.
 Use only replacement parts recommended by the manufacturer.
 * FTZ MODEL only

- RESISTORS**
- Are in ohms, 1/4 Watts, ±5% Tolerance
 Unless Otherwise Noted k kΩ, M, MΩ
- TOLERANCE**
 G ±2%
- CAPACITORS**
- Are in μF, Unless Otherwise Noted P pF
- ELECTROLYTIC CAPACITORS**
 Capacitance μF/Volts(V)

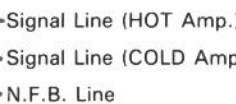

2SD600KF



A

B

C

D

6-5. Power Amp & Power Section <AU-X901>

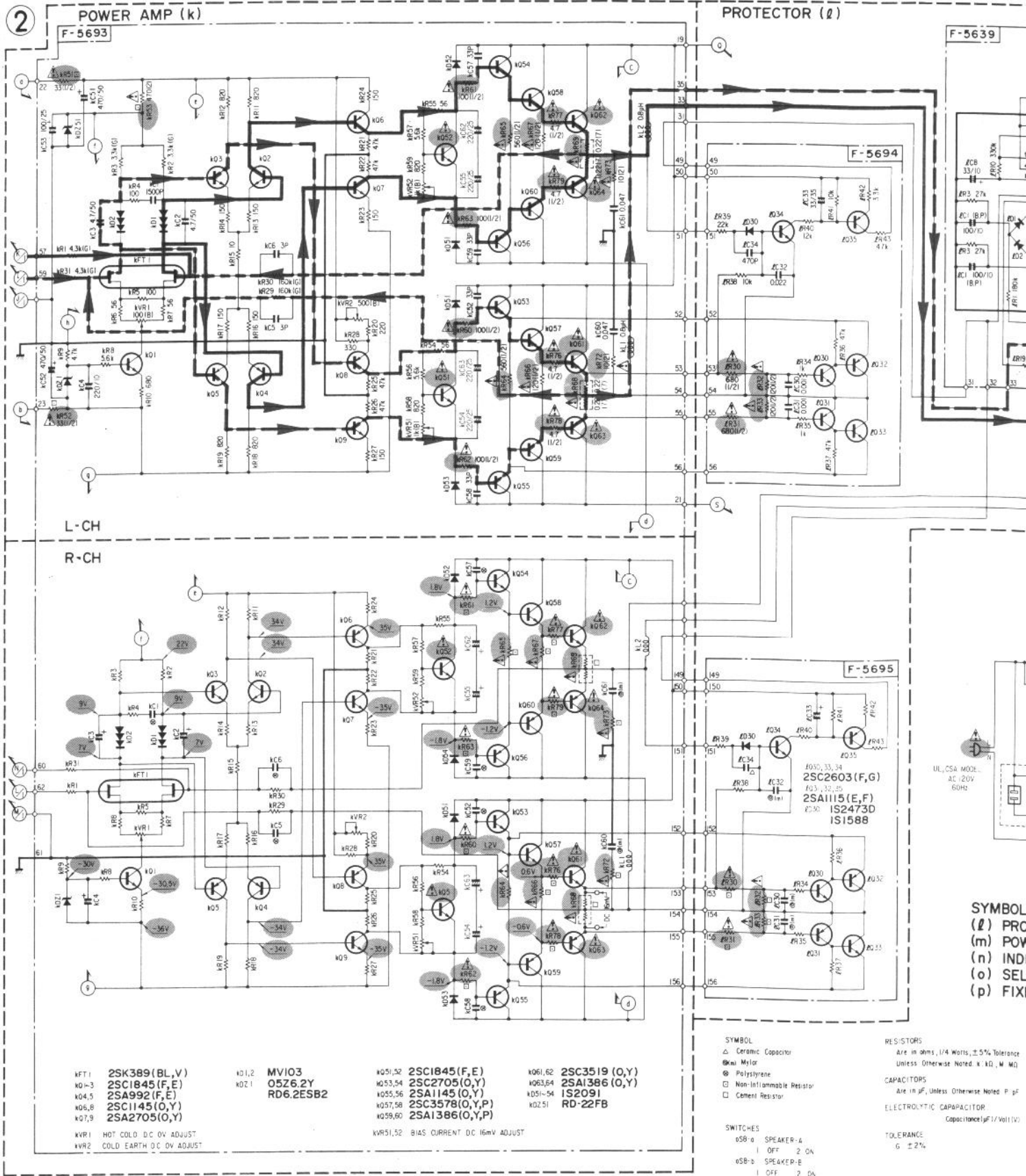

6-6. Power Supply (Primary Side) Section <AU-X701>

•AU-X701

④

XX MODEL (V)

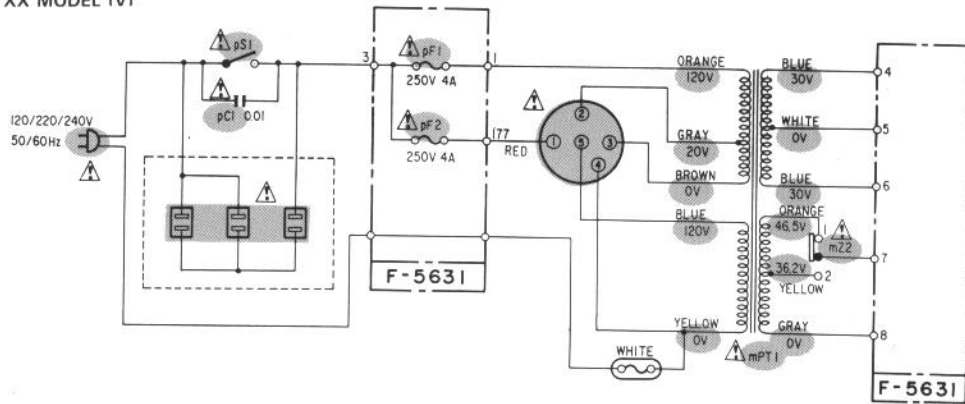

EU MODEL

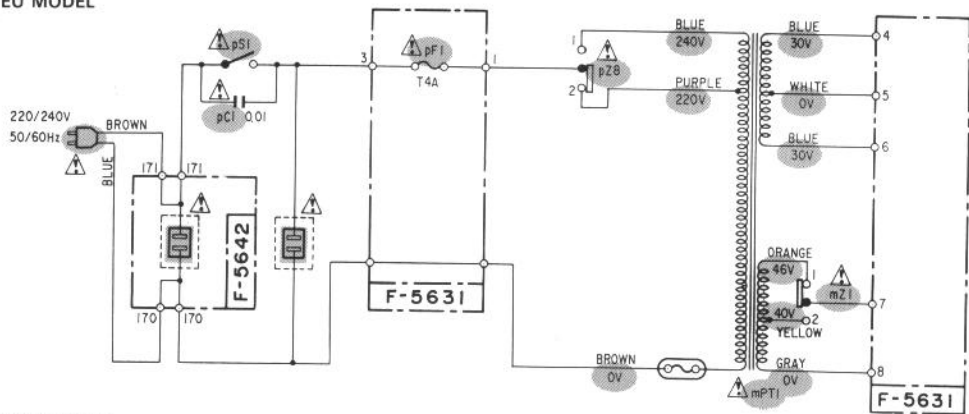

SEV MODEL

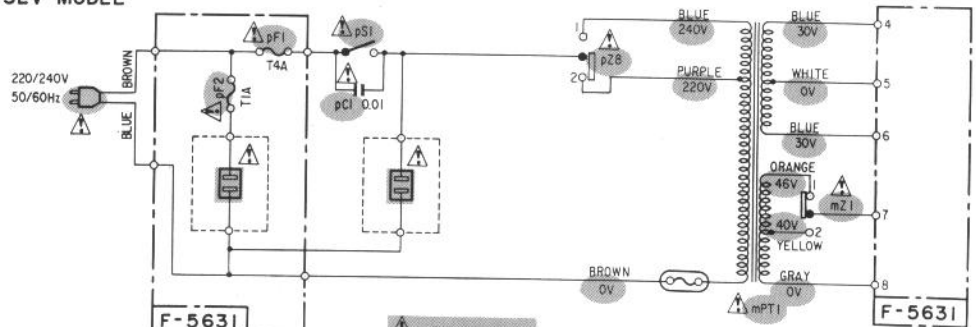

- pZ8 VOLTAGE SELECTOR
 1. 240V 2. 220V
- mZ1 SPEAKER IMPEADANCE SELECTOR
 1. A+B 8~12Ω, A,B 4~16Ω
 2. A+B 16Ω, A,B 8~16Ω

⚠ is Safety Part
 Use only replacement parts recommended by the manufacturer.

* Design and specifications subject to change without notice for improvement.
 * La présentation et les spécifications sont susceptibles d'être modifiées sans préavis par suites d'améliorations éventuelles.
 * Änderungen, die dem technischen Fortschritt dienen, bleiben vorbehalten.

6-7. Power Supply (Primary Side) Section <AU-X901>

•AU-X901

③

XX MODEL (V)

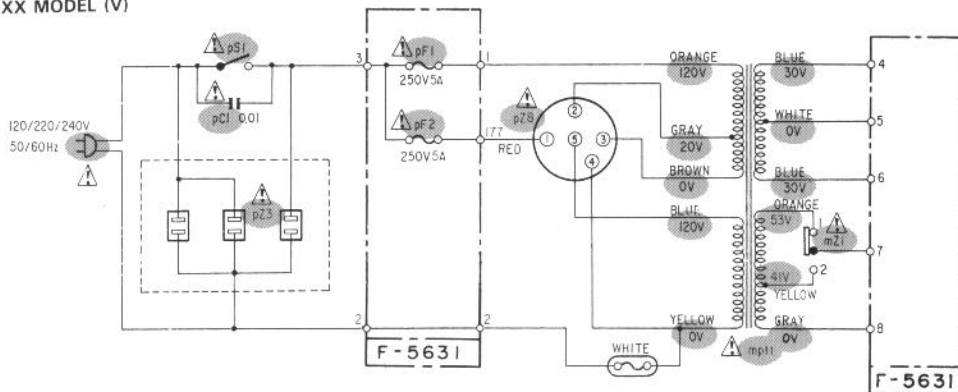

EU MODEL

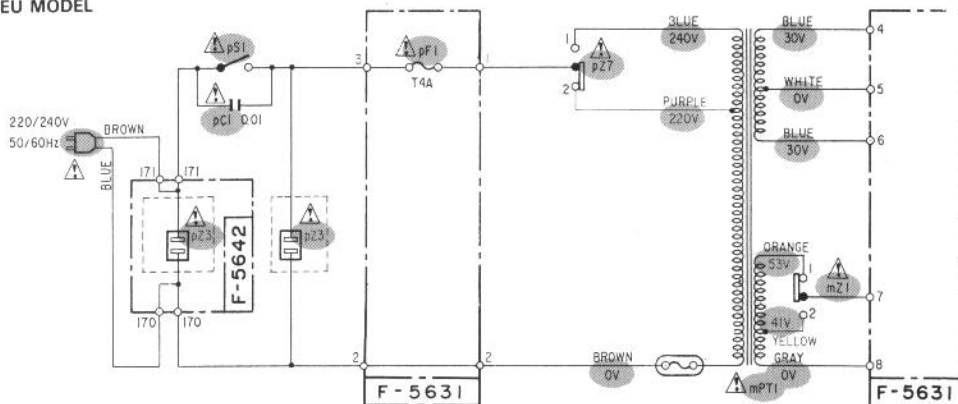

SEV MODEL

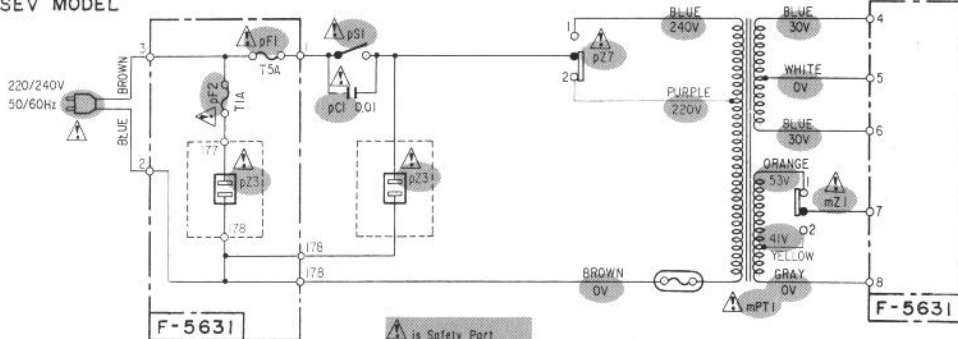

- pZ7 VOLTAGE SELECTOR
 1. 240V 2. 220V
- mZI SPEAKER IMPEADANCE SELECTOR
 1. A or B 8-16Ω A and B 16Ω
 2. A or B 4-6Ω A and B 8-12Ω

⚠ is Safety Part.
 Use only replacement parts recommended by the manufacturer.

- 2SA992
- 2SA1049
- 2SA1145
- 2SC1815
- 2SC1845
- 2SC2705

2SD357

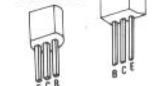

- 2SA1115
- 2SC2459
- 2SC2603

2SA1438

2SC3851

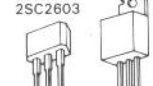

- 2SK163

2SA1386

2SC3519



- 2SK389



2SA1306

2SC3298



TA7317P



M5219L



- FMG-22S

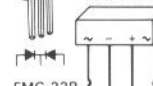

UB-152LFF



- FMG-22R



1S1588

1S2091

1S2473D

10E2

11E2



MV12

MV103

05Z2.7

05Z6.2

05Z7.5

05Z20

05Z24

05Z33

RD6 2E

RD22F

1

2

3

4

5

7. ADJUSTMENT

Condition: 1. Master Volume Minimum
 2. Room Temperature 18°C ~ 28°C (65°F ~ 83°F)

7-1. F-5693 Power Amp. Adjustment

STEP	SUBJECT	MEASURE OUTPUT	ADJUST	ADJUST FOR	REMARKS
1.	Center DC 0V Adj. <L-ch>	DC Voltage between Speaker Terminals COLD and GND <L-ch>	kVR2L	DC 0V ± 3 mV	<ul style="list-style-type: none"> •Set Speaker-A switch to "ON". •Set the POWER AMP DIRECT <AU-X901> switch to normal position.
2.	Center DC 0V Adj. <R-ch>	DC Voltage between Speaker Terminals COLD and GND <R-ch>	kVR2R	DC 0V ± 3 mV	
3.	Hot/Cold Balance Adj. <L-ch>	DC Voltage between Speaker Terminal HOT and GND. <L-ch>	kVR1L	DC 0V ± 3 mV	
4.	Hot/Cold Balance Adj. <R-ch>	DC Voltage between Speaker Terminal HOT and GND. <R-ch>	kVR1R	DC 0V ± 3 mV	

7-2. F-5643 Tone Control Amp. Adjustment <AU-X901>

STEP	SUBJECT	MEASURE OUTPUT	ADJUST	ADJUST FOR	REMARKS
1.	Center DC 0V Adj. <L-ch>	DC Voltage between F-5693 Point(A) (kR31) and Chassis (See Fig. 7-1)	jVR5L	DC 0V ± 3 mV	<ul style="list-style-type: none"> •For this adjustment, remove the front panel. •Set the POWER AMP DIRECT switch to integrated position. •Set Speaker-A switch to "ON".
2.	Center DC 0V Adj. <R-ch>	DC Voltage between F-5693 Point(B) (kR31) and Chassis (See Fig. 7-1)	jVR5R	DC 0V ± 3 mV	
3.	Hot/Cold Balance Adj. <L-ch>	DC Voltage between Speaker Terminals HOT and GND. <L-ch>	jVR6L	DC 0V ± 3 mV	
4.	Hot/Cold Balance Adj. <R-ch>	DC Voltage between Speaker Terminals HOT and GND. <R-ch>	jVR6R	DC 0V ± 3 mV	

Fig. 7-1 F-5693

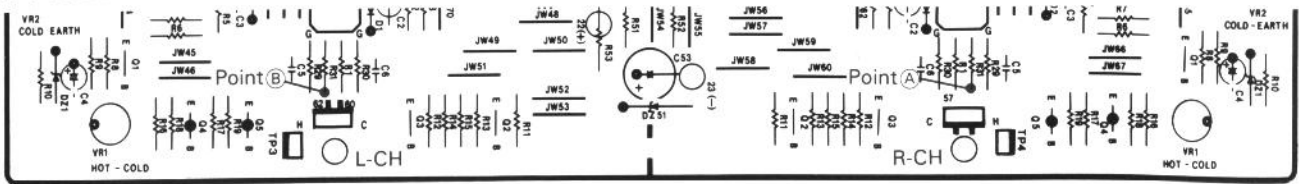

7-3. F-5693 Power Amp. Adjustment

- Note:** Perform this adjustment after the preheating (more than five minutes)
- Preheating**
 1. Arrange the connection as shown in Fig. 7-2.
 2. Set the output level of Audio OSC for obtaining 16.8V (35W) <AU-X701> or 20.6V (53W) <AU-X901> on the AC Volt Meter.
 3. Set the Volume to minimum position after the preheating.

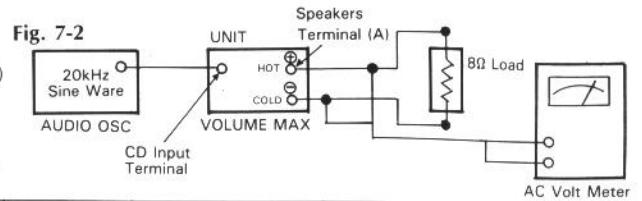

STEP	SUBJECT	MEASURE OUTPUT	ADJUST	ADJUST FOR	REMARKS
1.	Bias Current Adj. <Hot Side Amp. of L-ch>	DC Voltage between both edges of kR69 <L-ch> (See Fig. 7-3)	kVR52L	DC 17mV ± 2 mV	<ul style="list-style-type: none"> •Set the POWER AMP DIRECT <AU-X901> switch to normal position. •After this adjustment position (Bias Current), repeat procedures as stated in 7-1 & 7-2.
2.	Bias Current Adj. <Cold Side Amp. of L-ch>	DC Voltage between both edges of kR68 <L-ch> (See Fig. 7-3)	kVR51L	DC 17mV ± 2 mV	
3.	Bias Current Adj. <Hot Side Amp. of R-ch>	DC Voltage between both edges of kR69 <R-ch> (See Fig. 7-3)	kVR52R	DC 17mV ± 2 mV	
4.	Bias Current Adj. <Cold Side Amp. of R-ch>	DC Voltage between both edges of kR68 <R-ch> (See Fig. 7-3)	kVR51R	DC 17mV ± 2 mV	

Fig. 7-3 F-5693

