

2000 / 2000 SERIES TWO PREAMPLIFIER

Service Manual

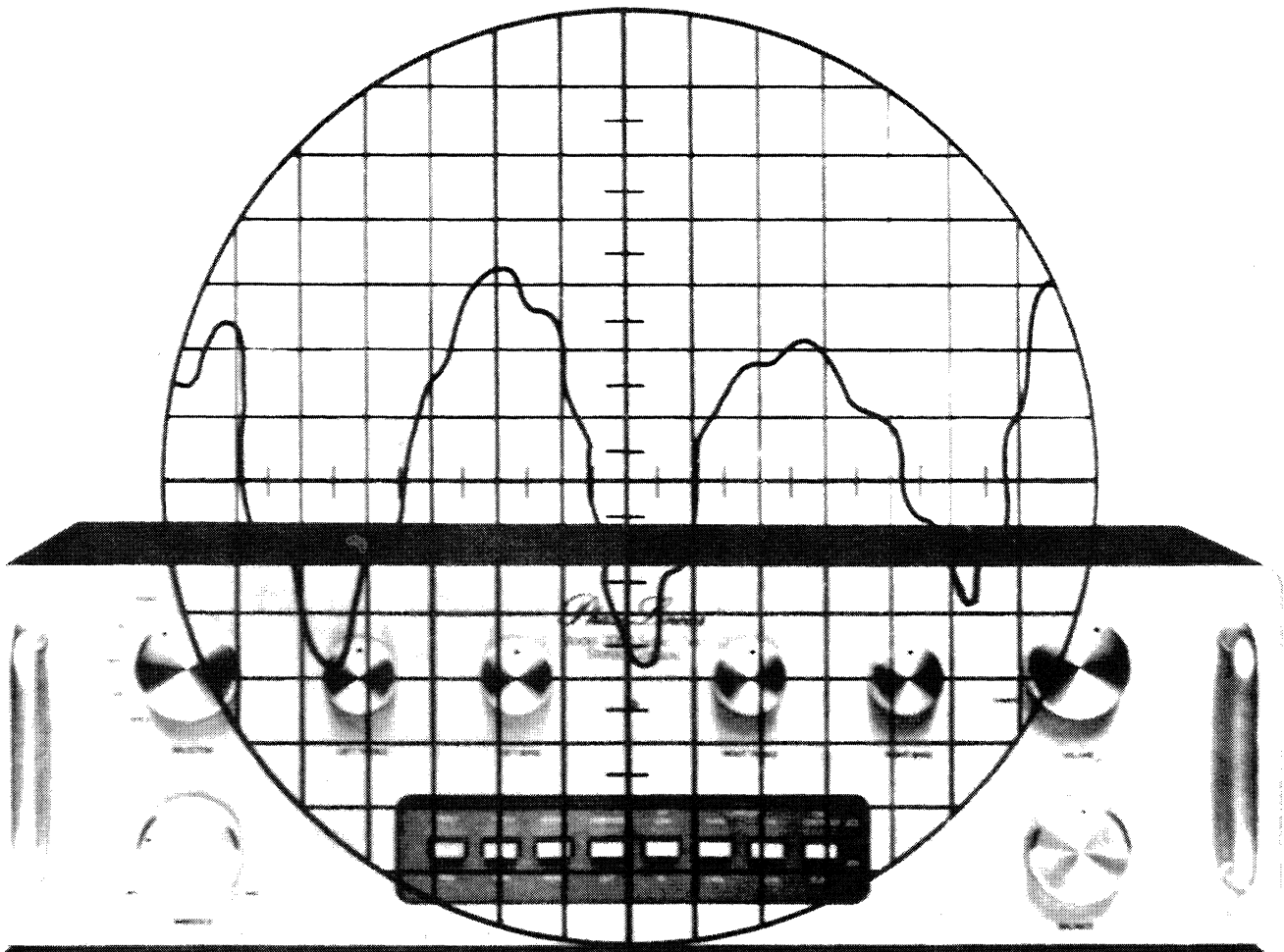

Phase Linear

THIS DOCUMENT
PROVIDED BY
WATTS_ABUNDANT.

CONTACT US AT

watts.abundant@yahoo.com

FOR PARTS AND
SERVICE

2000/2000II
STEREO PREAMPLIFIER

Service Manual

Contents:

	p.
1-0. SPECIFICATIONS	2
2-0. PERFORMANCE AND DESIGN FEATURES.	3
3-0. TECHNICAL CIRCUIT DESCRIPTIONS and SCHEMATIC and ASSEMBLY DIAGRAMS.	6
Schematic Diagram, Model 2000.	7
Assembly Diagram, Main PCB, Model 2000	8
Schematic Diagram, Model 2000II.	9
Assembly Diagram, Main PCB, Model 2000II . .	10
X-Ray View of 2000II Main PCB from Foil Sidell	
4-0. TEST PROCEDURE	12
5-0. TROUBLESHOOTING GUIDE.	14
6-0. 2000/2000II PARTS LIST	18
7-0. SERVICE BULLETINS and SUPPLEMENTS.	19

THIS MANUAL IS INTENDED FOR USE ONLY BY QUALIFIED PERSONNEL. HAZARDOUS VOLTAGES MAY BE ENCOUNTERED IN THE SERVICING OF THE MODEL 2000 OR 2000II, AND ONLY QUALIFIED PERSONNEL WITH PROPERLY INSULATED AND PROTECTED EQUIPMENT SHOULD ATTEMPT SERVICE. USE EXTREME CAUTION AND READ ALL INSTRUCTIONS CAREFULLY.

Phase Linear Service Department
20121 48th Ave. West
Lynnwood, WA 98036
Tel. (206) 774-8848
(206) 774-3571

prepared 7/76
1st rev 4/78
2nd rev 6/81

1-0. TECHNICAL SPECIFICATIONS

1-1. Performance Specifications

RATED OUTPUT VOLTAGE: 2.0 volts RMS

DISTORTION: Less than 0.05% at or below rated output,
20Hz-20kHz

SIGNAL-TO-NOISE RATIO(IHF A-WEIGHTED):

Phono - greater than 80dB re 10mV input

High Level - greater than 88dB below 2v output

INPUT IMPEDANCE:

Phono - 47k ohms in parallel with 33pF

High Level - greater than 40k ohms

INPUT SENSITIVITY(for rated output voltage):

Phono - 2.0mV

High Level - 200mV

FREQUENCY RESPONSE:

Phono - RIAA Deviation ± 0.5 dB

High Level - 20Hz-20kHz ± 0.5 dB

RESIDUAL NOISE LEVEL(IHF A-WEIGHTED)AT PREAMP OUTPUT:

Less than 100uV w/Phono selected

Less than 60uV w/High Level input selected

TONE CONTROLS:

Bass - Turnover frequency 50Hz, ± 1 dB @ 20Hz

Turnover frequency 150Hz, ± 1.3 dB @ 20Hz

Treble - Turnover frequency 5kHz, ± 1 dB @ 20kHz

Turnover frequency 2kHz, ± 1.4 dB @ 20kHz

MAXIMUM OUTPUT @ CLIPPING: 10 volts into 50k ohms @ 1kHz

PHONO OVERLOAD LEVEL(1kHz, THD 0.1%): 100mV

VOLUME CONTROL TRACKING: ± 1 dB

1-2. General Specifications

POWER REQUIREMENTS: Model 2000 - 117VAC/60Hz(USA & Canadian models)
220VAC/50Hz(Export models)

Model 2000II - 100-120/220-240VAC, 50/60Hz
switchable transformer primary

POWER CONSUMPTION: 5 watts

AC OUTLETS: 1 unswitched, 400 watts max.

2 switched, 400 watts max. total

DIMENSIONS: 19w x 5½h x 6d inches

48.3w x 14h x 15.2d centimeters

GROSS WEIGHT: Aluminum alloy chassis - 11 lbs.(5kg)

Steel chassis - 15 lbs.(6.8kg)

2-0. PERFORMANCE AND DESIGN FEATURES

2-1. Ambience

The model 2000/2000II is equipped with an ambience recovery system which can greatly enhance listening realism by adding an approximation of the natural reverberant acoustics of the concert hall which may be present in the recorded material. The amount of ambience which may be recovered by the preamplifier is dependent upon how the program material was originally recorded. Due to variations in recording techniques ambience content will vary from record to record. Due to the formula by which the ambient signal is extracted from the stereo signal, the greater the stereo separation of the signal the greater the amount of available ambience there is. With ambience added to the music it will sound more life-like.

NOTE: NO AMBIENCE CAN BE EXTRACTED FROM A MONOPHONIC SOURCE.

The ambience recovery system may be utilized in either of the two following configurations:

1) Operation of Ambience with a Conventional Stereo System:

The ambience control knob should be set fully counterclockwise with the AMBIENCE push button in the "out" position. Put on any program stereo source material and turn the ambience level up until a desirable level is attained; this position is usually around 1 or 2 o'clock. The greatest amount of ambience will be at a fully clockwise position.

The effect of the added ambience to the stereo channels can best be compared to the conventional stereo signal by performing an A-B test with the AMBIENCE push button. NOTE: When the ambience button is pushed "in" the ambience circuit is taken out of the signal path; when the button is in the "out" position the ambience circuit is engaged.

2) Operation of Ambience with an Additional Rear Channel Amplifier and Pair of Speakers:

The speakers should be arranged such that the front stereo pair is in front of the listener and the rear ambience pair is placed behind or to the sides of the listener. The amplifier driving the rear channel speakers should be connected to the 2000 MAIN REAR(RR,LR) outputs.

Once the program stereo source material has been selected the AMBIENCE push button may be utilized to place the ambience circuit in the signal path(button in the "out" position) and the amount of ambience delivered to the rear speakers can be controlled by the AMBIENCE level knob. It should be noted that the only signal from the MAIN REAR outputs of the 2000 is the ambience signal. Therefore as the AMBIENCE level control is rotated clockwise the volume in the rear channel speakers will increase.

2-2. TONE CONTROLS AND TURNOVER FREQUENCIES

The model 2000/2000II has adjustable tone control turnover points(see fig. 2-2). The turnover point is the place on the

frequency spectrum above and below which the tone controls will take effect. The turnover point for the bass controls may be set at 50Hz by leaving the low frequency turnover button "out". In the depressed position the turnover point is switched to 150Hz and the bass boost will be audibly greater. The turnover point for the treble is set at 5kHz with the high frequency turnover button in the "out" position. In the depressed position the turnover is switched to 2kHz which will increase the effects of the treble tone controls.

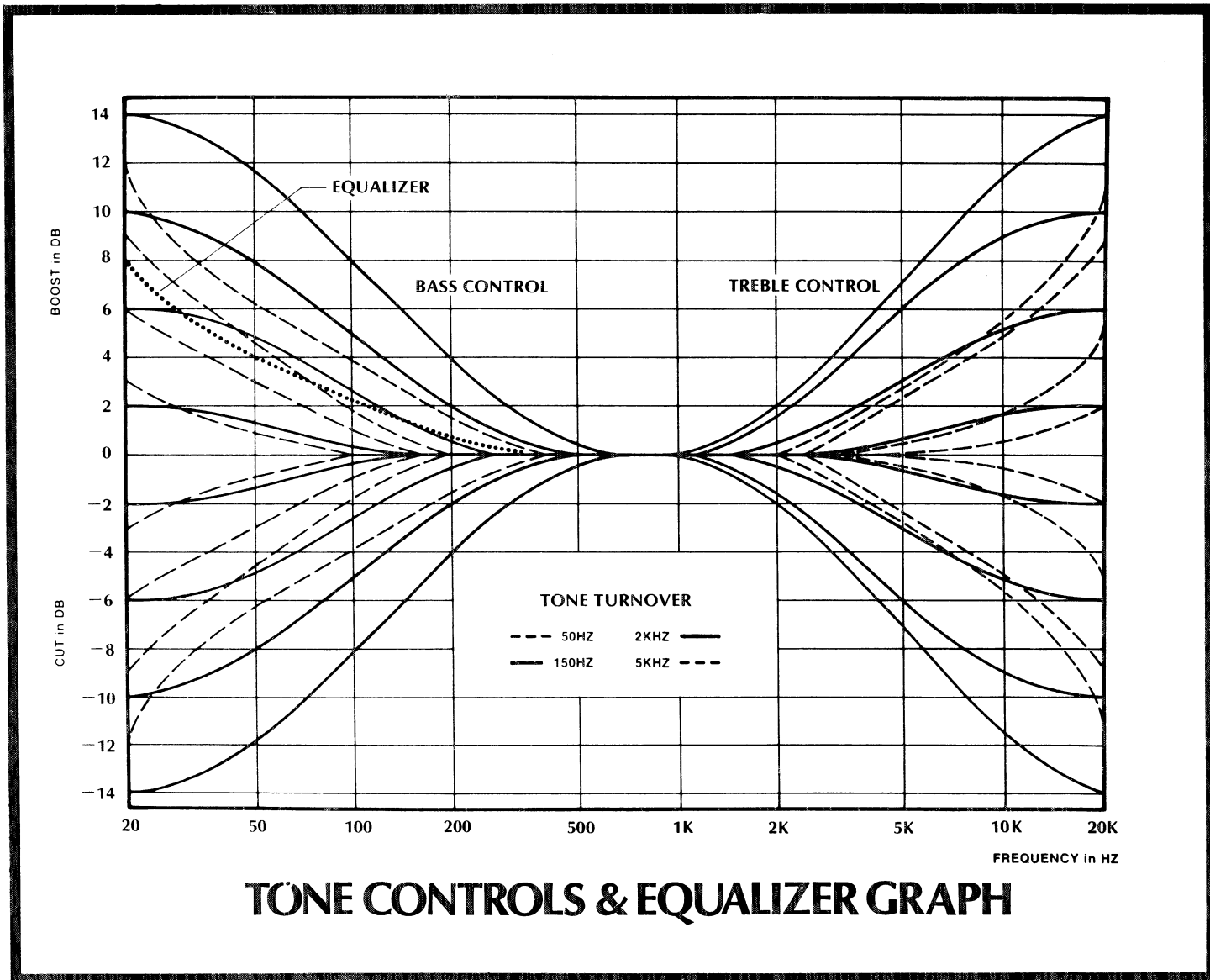

Fig. 2-2

The tone controls can boost or cut up to 12dB starting at the turnover point selected. There are separate bass and treble controls for greater flexibility. THE MODEL 2000 TONE CONTROLS ARE DESIGNED TO COMPENSATE FOR TYPICAL SPEAKER DEFICIENCIES AND NOT TO AUGMENT POOR SOURCE MATERIAL. THEY ARE THEREFORE SUBTLE IN EFFECT, SO AS NOT TO ALTER THE CRITICAL MID-FREQUENCY AREA, PREFERRING TO ACT INSTEAD ONLY ON THE HIGHEST AND LOWEST OCTAVES.

2-3. Low Equalizer

A switchable built-in active equalizer is provided to boost the extreme low frequencies (5dB @ 50Hz). The majority of loudspeaker systems exhibit a gradual roll-off below 50Hz in most listening rooms. The boost is designed to produce a flatter, more uniform total system response and is particularly useful when used together with powerful amplifiers and speaker systems exhibiting high power handling capabilities.

2-4. Tape Functions

The model 2000/2000II preamplifier is equipped with two complete tape-recording playback circuits which provide for a great deal of flexibility. In addition to the usual record and playback facilities for two tape decks it is also possible to copy from Tape 1 onto Tape 2 or vice-versa. Following are connection and operating instructions for using one or two tape machines:

1) Playback of Tape 1:

Set SELECTOR switch to the TAPE 1 position and insure that the TAPE 1 push button is in the "out" or SOURCE position.

2) Record on Tape 1:

Set SELECTOR switch to the desired source. With the TAPE 1 push button in the "out" position, the source being recorded will be heard. With the TAPE 1 button "in", the recording being made is monitored.

3) Playback of Tape 2:

Same as procedure 1) above for Tape 1.

4) Record on Tape 2:

Same as procedure 2) above for Tape 1.

5) Copy Tape 1 onto Tape 2:

Set the SELECTOR switch to TAPE 1 with the TAPE 1 button in the "out" or SOURCE position. With the TAPE 2 button "in", the new recording being made on TAPE 2 is monitored. To hear the original source (Tape 1) the TAPE 2 button must be in the "out" or SOURCE position.

6) Copy Tape 2 onto Tape 1:

Set the SELECTOR switch to TAPE 2 with the TAPE 2 button in the "out" or SOURCE position. When the TAPE 1 button is "in", the new recording being made on Tape 1 is monitored. To hear the original source (Tape 2) the TAPE 1 button should be "out". It should be noted that while dubbing from one tape machine to another only tape may be listened to.

NOTE: For the correct connection and operation of auxiliary equipment normally used in the tape path, such as equalizers, refer to the respective auxiliary equipment manufacturer's instruction manual.

3-0. TECHNICAL CIRCUIT DESCRIPTIONS/SCHEMATIC AND ASSEMBLY DIAGRAMS

3-1. Power Supply:

Power transformer secondary voltage is rectified through diodes D3-D6 giving $\pm 17\text{VDC}$ supply to all transistors and IC's.

3-2. Phono Circuit:

IC Z1(4739) serves as a non-inverting high-gain amplifier equalized to the RIAA standard curve and provides a gain of 41dB @ 2 kHz.

3-3. High Level Amplifier:

The input signal is applied through the selector switch, tape functions, and volume control(R17)to the first two stages of Z3 (4136)which provide a flat gain of 22dB and also provide a switchable low frequency gain of 8dB @ 20Hz(active equalizer).

3-4. Tone Circuit:

The remaining two stages of IC Z3(4136)serve as active tone amplifiers which have switchable turnover points.

3-5. Ambience Circuit:

A portion of the signal from the right channel volume pot R17 is buffered through transistor Q1 and applied with signal from left channel R17 to the inputs of difference amplifier Z2(4739). The output of this first stage of Z2 is applied to the right rear output jack, left channel summing resistor R24, and the remaining stage of Z2 through ambience control R45. This second stage of Z2 serves as an inverting buffer delivering an inverted difference signal to the left rear output and right front channel through summing resistor R23.

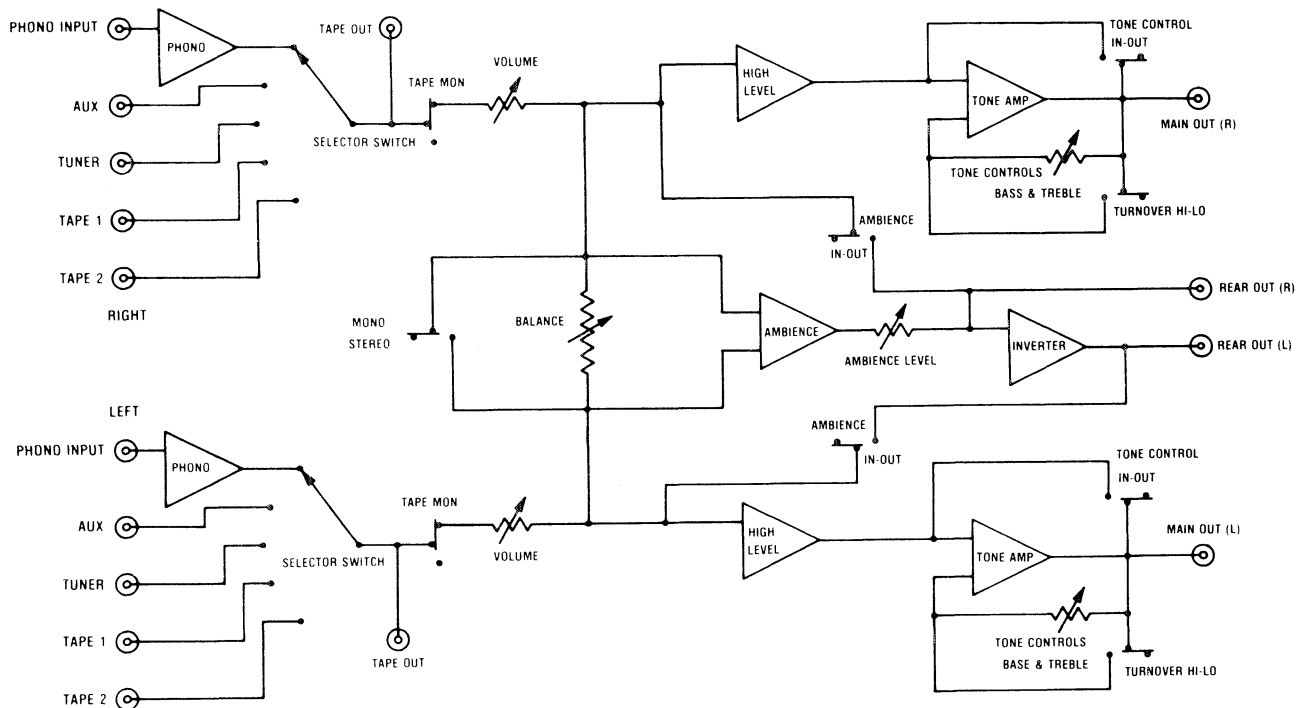

SIGNAL PATH DIAGRAM

DESIGN PICKERS	4-6-75
CMND	
APVD	
RELEASE STATUS	
PREL	
FINAL	
D	2000
E	402531

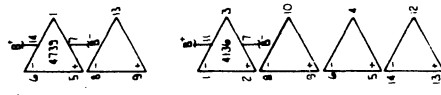
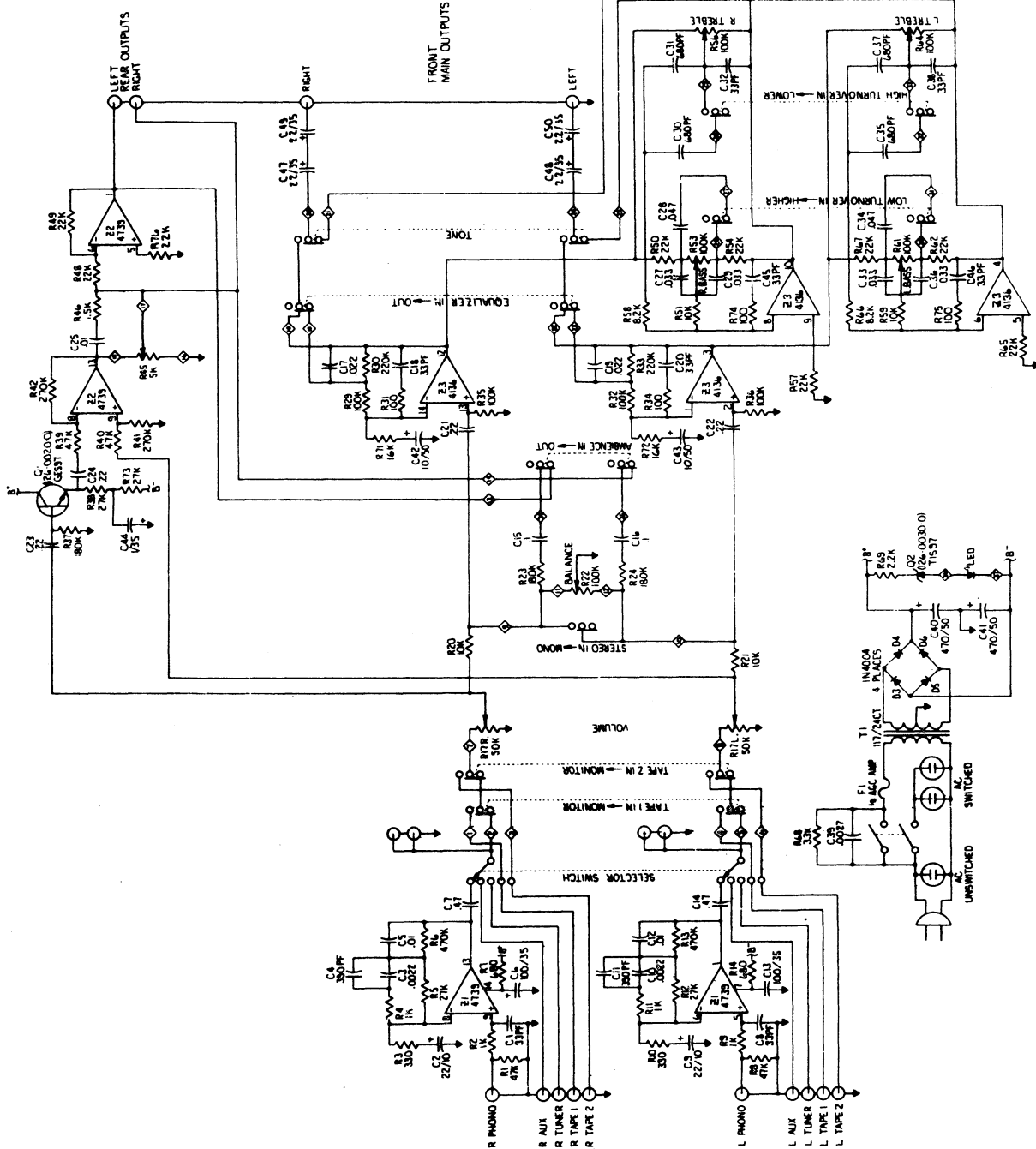

Schematic Diagram, Model 2000

DESIGN	PROJEN	16-8-75
CHWD	APVD	2-2-78
RELEASE STATUS		
PREL		
FINAL		
D	2000	900-0051-0 I

PHASE LINEAR

INTER CONNECT SCHEMATIC

2000 PREAMP

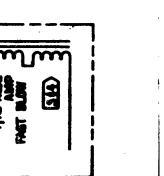
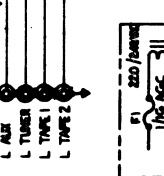
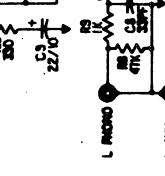
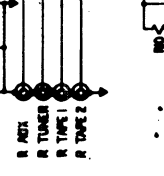
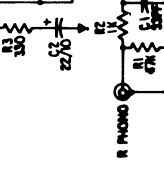
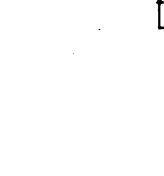
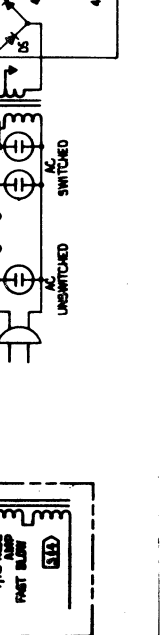
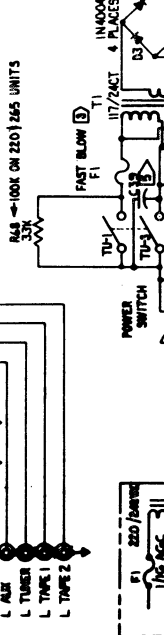
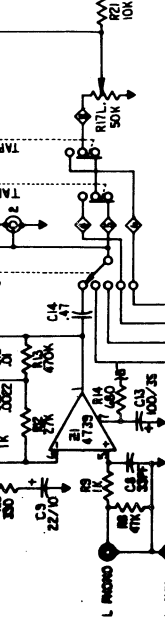
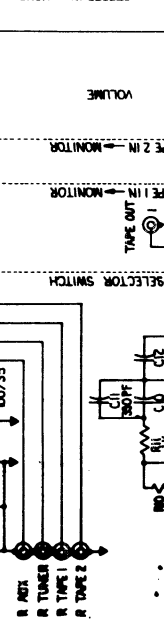
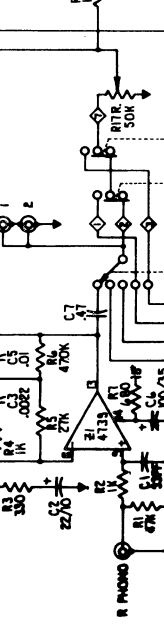
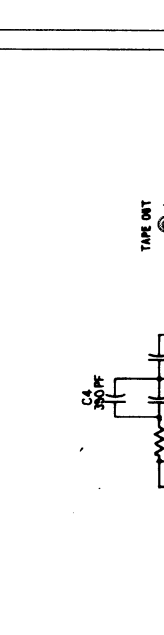
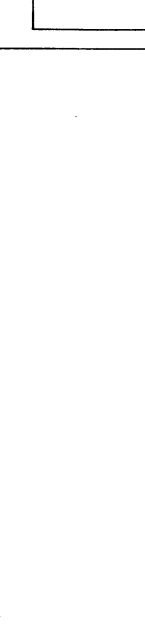
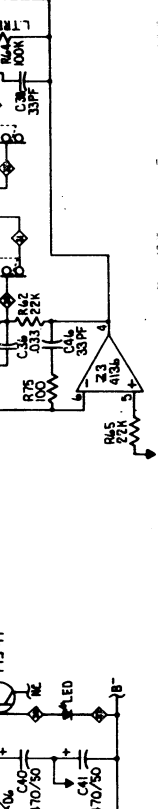
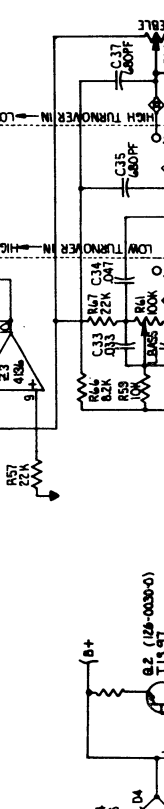
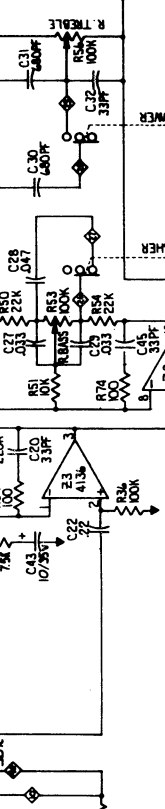
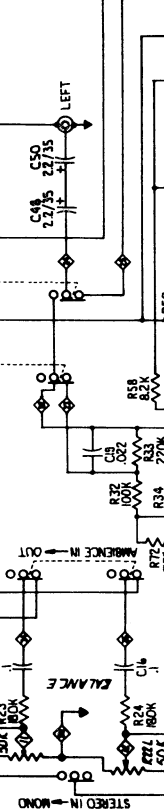
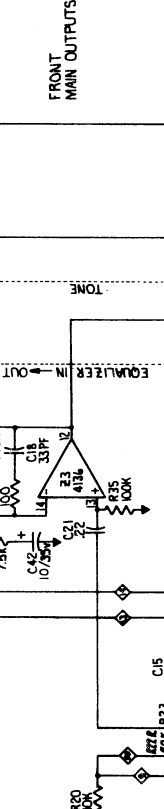
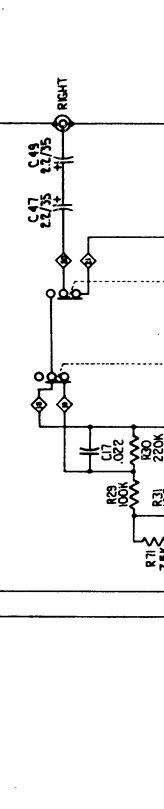
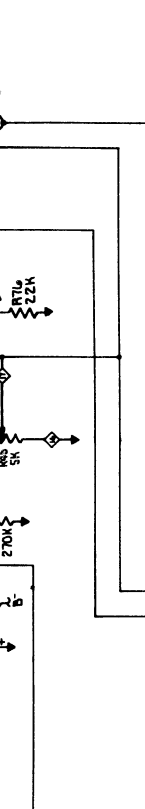

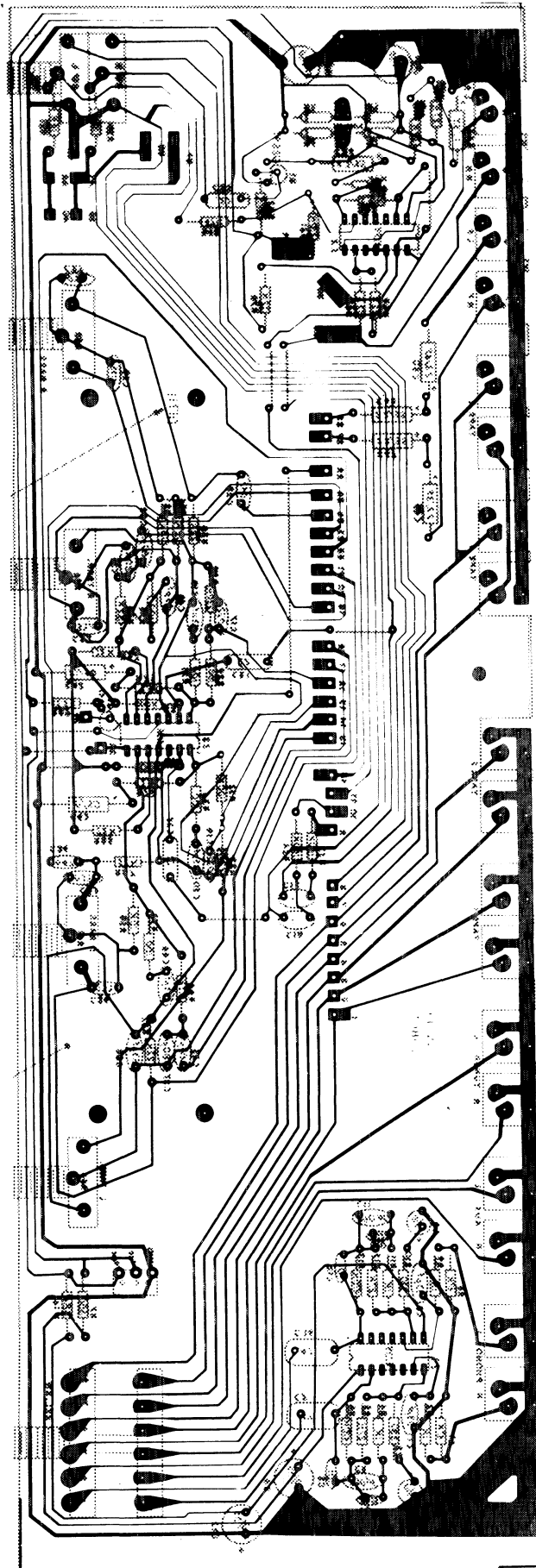

X-Ray View of 2000II Main PCB as Viewed from Foil Side

4-0. TEST PROCEDURE

Contents:

- 4-1. Energizing the Unit
- 4-2. Input Functions and Tape Monitor
- 4-3. Volume Pot Tracking and Balance Control
- 4-4. Stereo/Mono - Separation
- 4-5. Ambience
- 4-6. Tone Controls/Active Equalizer
- 4-7. Phono THD & S/N Ratio
- 4-8. High Level THD & S/N Ratio

Recommended Test Equipment:

Dual-trace Oscilloscope
AC Voltmeter(x2)
Signal Generator
Distortion Analyzer

NOTE: Unless otherwise specified all tests are to be performed with all auxiliary circuits (tone, active EQ and ambience) switched OUT and balance control centered.

5-1. Energizing the unit. Plug the 2000 line cord into the proper line voltage source. Switch the POWER/VOLUME control to "on" and verify that the power LED illuminates immediately.

5-2. Input Functions and Tape Monitor. Using each of the following inputs verify a signal at the corresponding indicated output. Proper switch position is determined by reading across the chart. High level inputs should be driven by a 250mV 2kHz sine wave signal; phono input should be driven by a 10mV 2kHz signal.

Input	Output	Selector	Tape Mon 1	Tape Mon 2
PHONO	MAIN	PHONO	out	out
AUX	MAIN	AUX	out	out
TUNER	MAIN	TUNER	out	out
TAPE 1	MAIN	TAPE 1	out	out
TAPE 2	MAIN	TAPE 2	out	out
TAPE 2	MAIN	AUX	out	in
TAPE 1	MAIN	AUX	in	out

5-3. Volume Pot Tracking and Balance Control. Select and drive the AUX inputs with a 250mV 2kHz signal and monitor the MAIN outputs with scope and voltmeters. With the balance control at 12 o'clock turn the volume control fully clockwise and then slowly turn it counterclockwise while observing the voltmeters. Verify that the left and right channels track within 1dB of each other.

Return the volume control to the reference position. Rotate the balance control fully clockwise, then fully counterclockwise while monitoring the signals on the scope. Verify that the proper corresponding channel becomes fully attenuated.

4-4. Stereo/Mono - Separation. Select and drive the AUX inputs with a 250mV 2kHz signal and obtain a 0dB reference on the AC voltmeters (set on the 1-volt scale). Unplug the left input and verify that the left output is removed with the 2000 in the STEREO mode. Push the STEREO/MONO switch to the MONO position and verify that both outputs read -6dB, ±1dB. Switch back to STEREO mode. Verify that any signal present in the left channel is -40dB or more below the right channel output.

4-5. Ambience. Select the drive the AUX inputs to obtain a 0dB reference reading on the voltmeters (set on the 1-volt scale). Remove one input, turn the AMBIENCE control fully counterclockwise and switch the AMBIENCE "in" (push button will physically be in the "out" position). Rotate the AMBIENCE control fully clockwise and verify that a signal appears at the undeiven channel's output which is 180 degrees out of phase and down -10dB from the reference channel. Connect scope and voltmeters to the rear outputs (MAIN RR,LR) and verify that the two channel signals are 180 degrees out of phase but equal in amplitude ±1dB.

4-6. Tone Controls/Active Equalizer. Drive the AUX inputs with a 250mV 2kHz signal and monitor the channel outputs on the scope and voltmeters. Engage the TONE CONTROLS (push button will be physically "out") and verify corresponding signals per the following chart and switch positions. All of the chart readings have a ±2dB tolerance.

Sig.Gen. Frequency	Turnover	Boost and Cut	Active EQ
12kHz	8kHz	±8dB	-
12kHz	2kHz	±13dB	-
50Hz	40Hz	±8dB	+8dB
50Hz	150Hz	±13dB	+8dB

4-7. Phono THD & S/N Ratio. Select and drive the PHONO inputs with a 10mV 1kHz signal. Connect the distortion analyzer inputs to the tape output and verify less than .05% THD. Remove the PHONO input and verify that phono output noise is approximately 74dB (unweighted) below 1 volt.

4-8. High Level THD and S/N Ratio. Select and drive the AUX inputs with a 250mV 1kHz signal and obtain a 2-volt output. Using one channel at a time connect the distortion analyzer to each MAIN output and verify that noise is approximately 88dB (unweighted) below 2 volts.

5-0. TROUBLESHOOTING GUIDE

Contents:

- 5-1. Power Supply/Switched AC Outlet Malfunction
- 5-2. Input/Tape Monitor Malfunction
- 5-3. Volume Control Tracking/Balance Malfunction
- 5-4. Stereo/Mono - Separation Malfunction
- 5-5. Ambience Malfunction
- 5-6. Tone Controls/Active Equalizer Malfunction
- 5-7. Phono THD & S/N Ratio
- 5-8. High Level THD & S/N Ratio

5-1. Power Supply/Switched AC Outlet Malfunction

5-1.1. Power LED will not illuminate.

- a) Check line fuse. Fuse values should be 1/8-amp (.125-amp) for 110-120v models and 1/16-amp (.0625-amp) for 220-240 volt models.
- b) Check continuity of power switch contacts. Replace power switch/volume control if necessary.
- c) Check continuity of line cord.

5-1.2. Switched AC outlets inoperable or intermittent.

- a) Check continuity of power switch and replace switch if necessary. NOTE: Be sure to replace (or install if necessary) the .01/1000v disc capacitor across the switched outlet terminals on the power switch since this greatly extends the life of the switch contacts. See diagram 5-1 on page 17.

5-1.3. Main output "snap" or "pop" when power switch is turned on or off.

- a) Replace (or install if necessary) .0027/150v disc capacitor across preamp power terminals of power switch (two upper terminals). See diagram 5-1 on page 17.

5-2. Input/Tape Monitor Malfunction

5-2.1. Loss of one or both channels.

- a) Check output of Z3(4136) and replace as necessary.
- b) Since the tape monitor switches override the input selector, the loss of one or both channels may be caused by a defective tape monitor switch. Check switch continuity and replace the switch assembly as necessary.
- c) Check remaining switches in the switch assembly for intermittent contact. Cleaning or replacement may be necessary. This is rarely a problem in the 2000II, but may occur occasionally with the model 2000.

5-2.2. Oscillation when 3-head tape deck is utilized through selector inputs(not tape monitor).

a) Some 3-head tape decks do not disconnect their record electronics while in the play mode. This can cause a feedback loop back into the tape deck from the preamp tape outputs and consequently oscillate.

To solve this problem utilize the tape monitor circuit (TAPE 1 or TAPE 2) on the preamp in conjunction with the tape deck rather than using the selector switch tape input circuit.

5-3. Volume Pot Mistracking.

a) Perform volume control tracing and balance tests as outlined in section 4-3. Replace volume control as necessary.

5-4. Poor Separation.

a) Perform channel separation test as outlined in section 4-4. If the unit fails to meet separation specs it is most likely due to a failure of one or more of the self-shortening input/output jacks to make proper shorting of the contacts. Adjust and/or clean shorting contacts as necessary.

5-5. Ambience Malfunction.

5-1.1. No ambience.

a) Replace Z2(4739)and/or Q1(GES97)as necessary.

b) Check AMBIENCE control pot.

5-1.2. Hum or noise with AMBIENCE in circuit.

a) Replace Z2(4739).

5-6. Tone Controls/Active EQ Malfunction.

5-6.1. Loss of one channel when tone circuit is "in".

a) Clean and lubricate switch assembly contacts.

b) Replace Z3(4136).

c) Replace switch assembly.

5-6.2. Tone controls oscillate at extreme boost or cut position.

a) On 2000II units check/replace C45/R74 or C46/R75.

b) On pre-Series Two 2000 units install RC combination of 33pF disc cap and 100-ohm ½-watt resistor in series and connect this RC combination to respective leads of R62/R66 and R54/R58 for each channel as shown on 2000 Main PCB Assembly Diagram, page 8.

6-5.3. High DC offset from one or both channels with tone controls in.

a) Check for broken tone control pot. Since the tone control shafts are the primary means of support for the main PC board to the chassis, the tone pots may break from impact stress if the unit is dropped or handled roughly. This condition is also sometimes difficult to examine since the break may occur within the pot case. Remove the front panel for a positive inspection.

5-7. Phono THD & S/N

5-7.1. Excessive distortion or noise in phono circuit.

- a) Replace Z1(4739).
- b) Check shorting input/output jacks and clean and adjust or replace as necessary.

5-8. High Level THD & S/N Ratio

5-8.1. Excessive distortion or noise in high level input functions.

- a) Replace Z3(4136).
- b) Check shorting input/output jacks and clean and adjust or replace as necessary.

NOTE:

In certain applications of the model 2000 preamp(not the model 2000II)involving use with power amplifiers with low input sensitivity and/or low gain, it may be desirable to increase the overall gain of the 2000 to accommodate lower output cartridges and tape decks.

A voltage gain of approximately 6dB may be easily obtained by adding in parallel to R71 and R72 a second resistor of the same value. In earlier production models where R71 and R72 are 22k-ohms, add another 22k-ohm resistor in parallel to each for the gain increase. In later productions models where R71 and R72 are 16k-ohms, parallel each with another 16k-ohm resistor for the gain increase. No other alteration or modifications are necessary.

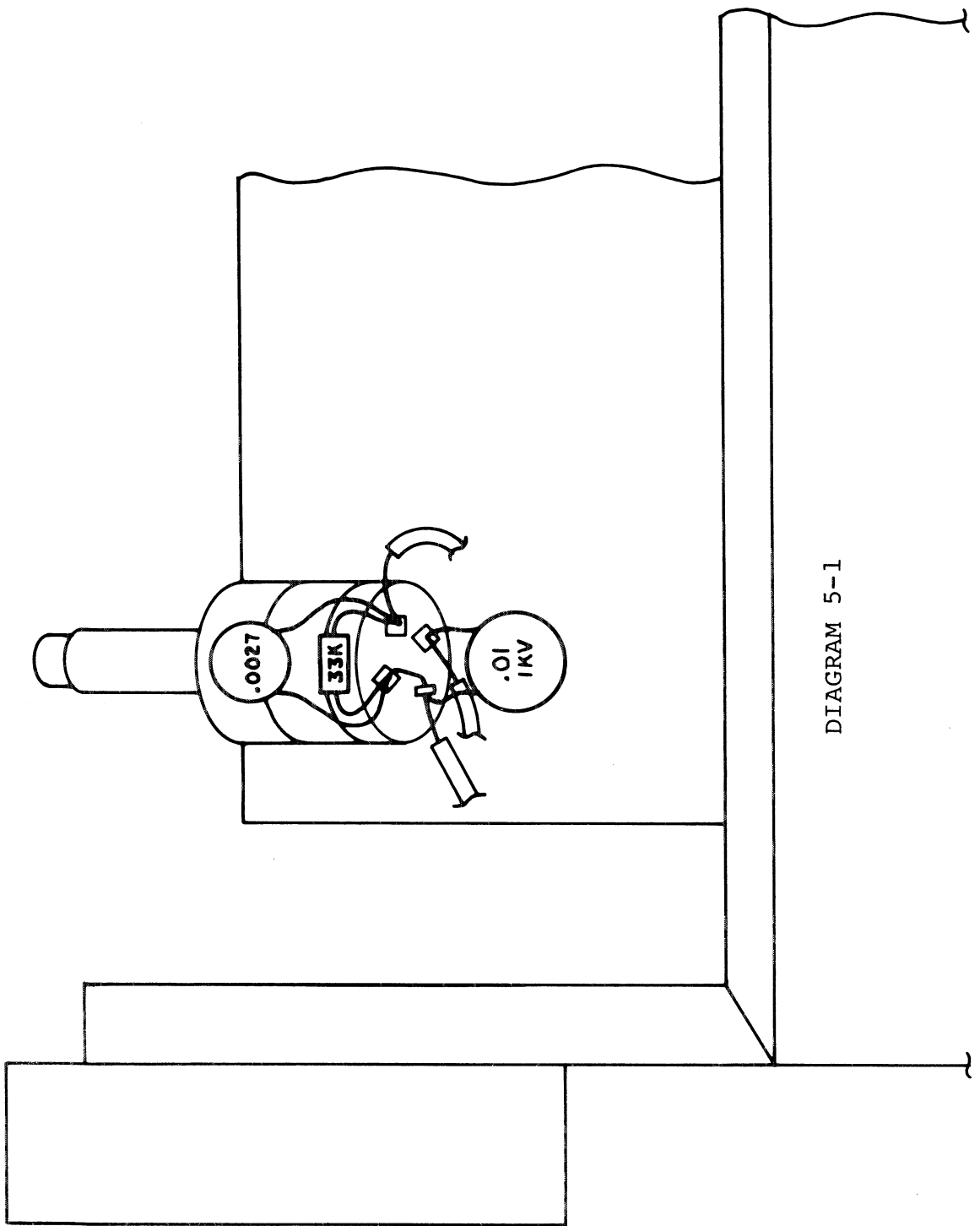

6-0. 2000/2000II PARTS LIST

TRANSISTORS: PL Part No.
 GES97, TIS97.....126-0033

INTEGRATED CIRCUITS:

RC4136.....126-0027
 RC4739.....126-0029

DIODES:

1N4004.....126-0003
 LED, red(2000).....126-0019
 LED, amber(2000II).....126-0065

CAPACITORS:¹

.01/1000v:disc.....127-0066
 .0027/150v:disc.....126-0049
 470/50v:lytic.....127-0038
 100/35v:lytic.....127-0034
 10/35v:lytic.....127-0035
 4.7/35v:lytic.....127-0037
 2.2/35v:lytic.....127-0068
 1/35v:lytic.....127-0036
 22/10v:lytic.....127-0078
 .47/100v:mylar.....127-0014
 .22/100v:mylar.....127-0028
 .1/100v:mylar.....127-0015
 .047/100v:mylar.....127-0058
 .033/100v:mylar.....127-0025
 .022/100v:mylar.....127-0059

SWITCHES:

POWER/VOL(2000/2000II).129-0025
 Selector:5-pos:rot.....129-0029
 Switch Assy:8-sta:2000.129-0024
 Sw. Assy:8-sta:2000II..129-0092

POTENTIOMETERS:

VOL/PWR Sw:50k:NL:dual.129-0025
 TONE:100k:L.....129-0028
 Balance:50k:NL:dual...129-0037
 Balance:100k:L.....129-0026
 Ambience:5k:NL.....129-0027

TRANSFORMER² PL Part No.
 117/24v:CT.....125-0009
 220/24v:CT.....125-0010

PRINTED CIRCUIT BOARDS:

PL22 Main PCB(2000)....210-0065
 PL22 Main PCB(2000II)..210-0141
 Switch PCB Assy(2000)..210-0030
 Switch PCB Assy(2000II)210-0142

FRONT PANEL COMPONENTS:

Knob:1.5"dia.....142-0038
 Knob:1.1"dia.....142-0039
 Push button:bl:2000....121-0065
 Push button:pl:2000II..142-0028
 Handle(2000II).....142-0027
 Handle ferrule(2000II).143-0015

METALWORK:

Front panel:2000210-0011
 Front panel:2000II.....210-0028
 Sub-front panel:2000II.220-0030
 Cover:top:2000/2000II..141-0126
 Cover:bottom:2000.....141-0027
 Cover:bottom:2000II....141-0127
 Chassis:2000.....220-0010
 Chassis:2000II.....220-0029

HARDWARE:

Nut:pot shaft:3/8-32...122-0042
 Nut:hex:¼-20.....122-0015
 Handle screw:2000II....122-0092
 Screw:top,btm.cover....122-0123

MISCELLANEOUS:

Jack:phono:PCB-mount...121-0022
 Line cord:l6-2.....121-0021
 Fuseholder:AGC.....121-0010
 Fuse:AGC-1/8.....121-0067
 Grounding post.....121-0019
 AC outlet.....121-0009

¹All values in microfarrads unles otherwise noted.

²Dual-primary power transformers which were used in the model 2000II are no longer available. If the transformer is defective or if the unit is to be set up to operate on a different AC line voltage the transformer for the given operational line voltage must be installed.

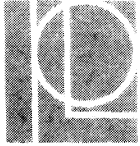

Phase Linear Corporation

20121-48 Avenue West
Lynnwood, Washington 98036 USA
206 774-3571 TWX 9104492851

SERVICE BULLETIN

2-76
rev 6-81

SUBJECT: Defective IC Date Code Lots

The following two IC's with the given date codes as marked on the IC case have been found to have excessively high failure rates and should automatically be replaced with a newer date coded device of the same type.

<u>Vendor</u>	<u>IC</u>	<u>Date Code</u>
Raytheon	RC4136	7505, 7518, 7520
Raytheon	RC4739	7513 or earlier(7505, etc.)

A description of fendor, IC number and date code location is as follows:

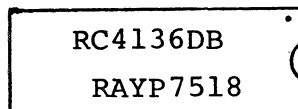

These IC's were only used in pre-Series Two models 1000, 2000 and 4000. They were not used in any production runs of Series Two products.