



McIntosh Laboratory, Inc. 2 Chambers Street Binghamton, New York 13903-2699 Phone: 607-723-3512 www.mcintoshlabs.com

MC275
Tube Power Amplifier
Owner's Manual





The lightning flash with arrowhead, within an equilateral triangle, is intended to alert the user to the presence of uninsulated "dangerous voltage" within the product's enclosure that may be of sufficient magnitude to constitute a risk of electric shock to persons.

WARNING - TO REDUCE RISK OF FIRE OR ELECTRICAL SHOCK, DO NOT EXPOSE THIS EQUIPMENT TO RAIN OR MOISTURE.



AVIS RISQUE DE CHOC ELECTRIQUE - NE PAS OUVRIR.

NO USER-SERVICEABLE PARTS INSIDE. REFER SERVICING TO QUALIFIED PERSONNEL.

The exclamation point within an equilateral triangle is intended to alert the user to the presence of important operating and maintenance (servicing) instructions in the literature accompanying the appliance.

To prevent the risk of electric shock, do not remove cover or back. No user-serviceable parts inside.

IMPORTANT SAFETY INSTRUCTIONS!

PLEASE READ THEM BEFORE OPERATING THIS EQUIPMENT.

1. Read these instructions.
2. Keep these instructions.
3. Heed all warnings.
4. Follow all instructions.
5. Do not use this apparatus near water.
6. Clean only with a dry cloth.
7. Do not block any ventilation openings. Install in accordance with the manufacturer's instructions.
8. Do not install near any heat sources such as radiators, heat registers, stoves, or other apparatus (including amplifiers) that produce heat.
9. Do not defeat the safety purpose of the polarized or grounding-type plug. A polarized plug has two blades with one wider than the other. A grounding type plug has two blades and a

third grounding prong. The wide blade or the third prong are provided for your safety. If the provided plug does not fit into your outlet, consult an electrician for replacement of the obsolete outlet.

10. Protect the power cord from being walked on or pinched particularly at plugs, convenience receptacles, and the point where they exit from the apparatus.
11. Only use attachments/accessories specified by the manufacturer.
12. Use only with the cart, stand, tripod, bracket, or table specified by the manufacturer, or sold with the apparatus. When a cart is used, use caution when moving the cart/apparatus combination to avoid injury from tip-over.
13. Unplug this apparatus during lightning storms or when unused for long periods of time.
14. Refer all servicing to qualified service personnel. Servicing is required when the apparatus has been damaged in any way, such as power-



supply cord or plug is damaged, liquid has been spilled or objects have fallen into the apparatus, the apparatus has been exposed to rain or moisture, does not operate normally, or has been dropped.

15. Do not expose this equipment to dripping or splashing and ensure that no objects filled with liquids, such as vases, are placed on the equipment.
16. To completely disconnect this equipment from the a.c. mains, disconnect the power supply cord plug from the a.c. receptacle.
17. The mains plug of the power supply cord shall remain readily operable.
18. Do not expose batteries to excessive heat such as sunshine, fire or the like.
19. Connect mains power supply cord only to a mains socket outlet with a protective earthing connection.

IMPORTANT!

**INSTRUCTIONS FOR REMOVAL
OF FOAM INSERT OVER THE
VACUUM TUBES PRIOR TO
CONNECTING THE A.C. POWER
SUPPLY CORD, START ON THE
NEXT PAGE.**





Unpacking the MC275

Caution: To prevent damage to the MC275 Tubes during shipping, there is a special foam insert surrounding the Tubes of the Power Amplifier.

The Foam Insert must be removed from the MC275 before connecting the AC Power Supply Cord to the power amplifier.

Failure to do so has the potential of a Fire Hazard, resulting in damage to the MC275 and the surrounding environment.

Follow these instructions for removal of the packing foam before connecting the AC Power Supply Cord to the MC275.

In order to remove the foam insert surrounding the tubes on the MC275, it is necessary to temporarily remove the Tube Cover. After the foam insert is removed, the Tube Cover is re-installed and should not be removed. The cover provides protection from the hazardous voltages inside the MC275. The MC275 has no

user serviceable parts, including the tubes. If repairs are needed they must be performed by an authorized McIntosh Service Agency.

1. Orient the MC275 so the Front is facing you and remove the Warning Sheet. Refer to figure 1.
2. Using a Philips Head #2 screw driver, remove the Tube Cover Screw securing the Tube Cover to the chassis on each side of the MC275. Refer to figure 2.
3. Carefully lift up and remove the Tube Cover from the MC275. Refer to figure 3.
4. Place the Tube Cover and the previously removed chassis screws in a safe location, as the Tube Cover will be reinstalled.

4. Carefully lift up and remove the Foam Insert from the MC275 exposing the Tubes. Refer to figures 4 and 5.

5. Carefully reinstall the previously removed Tube Cover using a Tube Cover Screw on each side of the MC275. Refer to figures 6, 7A, 7B and 8.

Note: Only use the chassis screws supplied with the MC275. If you can not find the chassis screws, contact the McIntosh Parts Department for replacements.

6. Save the Foam Insert and Warning Sheet with the MC275 Shipping Carton for possible future use.

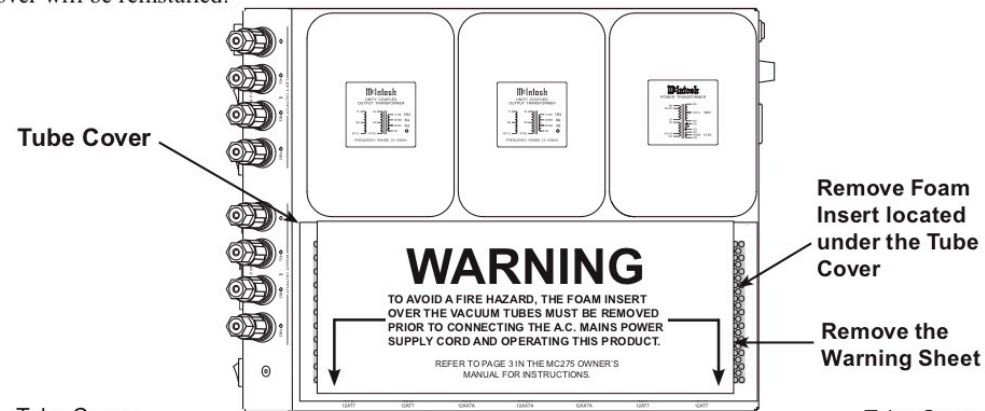

Figure 1

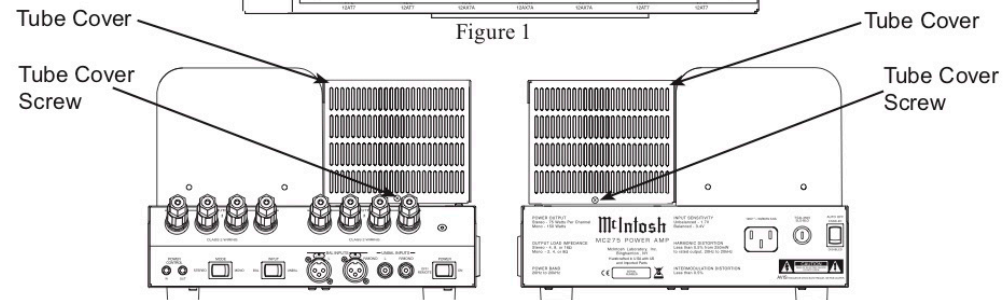

Figure 2

Figure 3

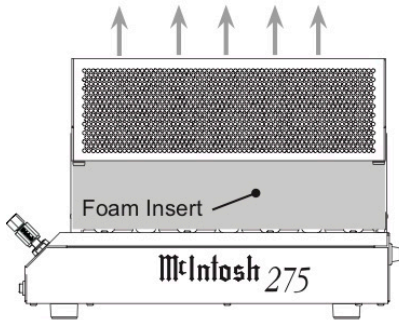

Figure 6

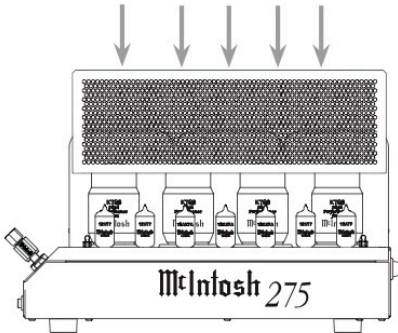

Figure 4

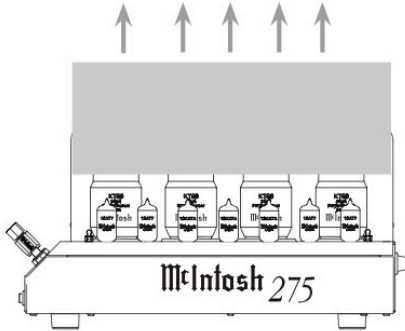

Figure 7A

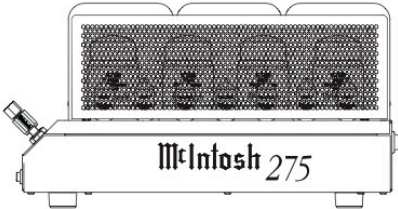

Figure 5

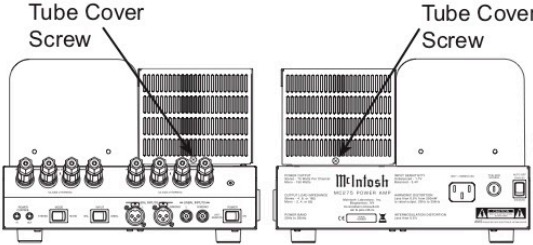
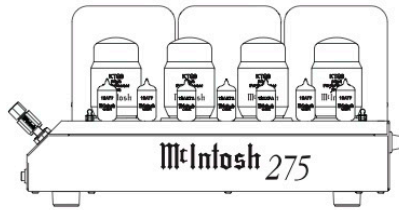

Figure 7B

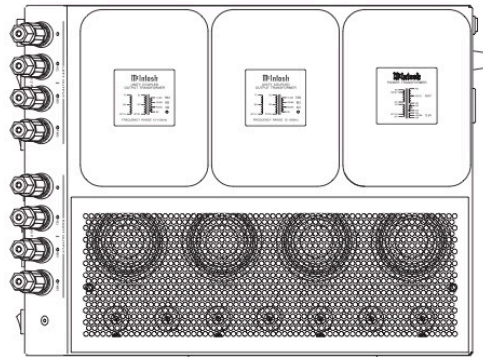

Figure 8

Ventilation

Adequate ventilation extends the trouble free life of the MC275. Always allow air to flow through the ventilation holes on the bottom of the amplifier and a means for the warm air to escape at the top. Refer to figure 9.

Allow at least 19 inches (48.3cm) above the top; 4 inches (10.2cm) for the Rear and Sides; allow 1/2 inch (1.3cm) below the Power Amplifier so the airflow is not obstructed.

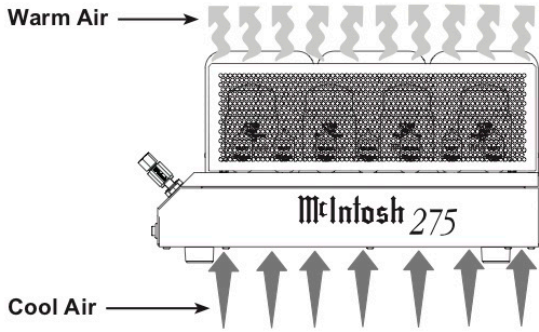

Figure 9



Thank You

Your decision to own this McIntosh MC275 Tube Power Amplifier ranks you at the very top among discriminating music listeners. You now have “The Best.” The McIntosh dedication to “Quality,” is assurance that you will receive many years of musical enjoyment from this unit.

Please take a short time to read the information in this manual. We want you to be as familiar as possible with all the features and functions of your new McIntosh.

Please Take A Moment

The serial number, purchase date and McIntosh Dealer name are important to you for possible insurance claim or future service. The spaces below have been provided for you to record that information:

Serial Number: _____

Purchase Date: _____

Dealer Name: _____

Technical Assistance

If at any time you have questions about your McIntosh product, contact your McIntosh Dealer who is familiar with your McIntosh equipment and any other brands that may be part of your system. If you or your Dealer wish additional help concerning a suspected problem, you can receive technical assistance for all McIntosh products at:

McIntosh Laboratory, Inc.
2 Chambers Street
Binghamton, New York 13903
Phone: 607-723-1545
Fax: 607-724-0549

Customer Service

If it is determined that your McIntosh product is in need of repair, you can return it to your Dealer. You can also return it to the McIntosh Laboratory Service Department. For assistance on factory repair return procedure, contact the McIntosh Service Department at:
McIntosh Laboratory, Inc
2 Chambers Street
Binghamton, New York 13903
Phone: 607-723-3515
Fax: 607-723-1917

Table of Contents

Safety Instructions	2-3
Unpacking the MC275 and Ventilation.....	4-5
Thank You and Please Take a Moment.....	6
Technical Assistance and Customer Service	6
Table of Contents	6
General Information	6
Connector Information	7
Introduction.....	7
Performance Features	7
Dimensions	8
Left Side Connections; Indicator and Switch: Right Side Connection, Fuse Holder and Switch.....	9
How to Connect for Stereo Operation	10
Connection Diagram (Separate Sheet).....	Mc1A
How to Connect for Monaural Operation.....	12
Connection Diagram (Separate Sheet).....	Mc1B
Right Side Switch, Left Side Switch and Indicators .	14
How to Operate.....	15
Photos.....	16-17
Specifications.....	18
Packing Instruction.....	19

General Information

1. For additional connection information, refer to the owner’s manual(s) for any component(s) connected to the MC275.
2. The MC275 mutes the speaker output for approximately fifteen seconds when first turned on.
3. For the best performance and safety it is important to always match the impedance of the loudspeaker to the Power Amplifier connections. Refer to pages 10 thru 13.

Note: The impedance of a Loudspeaker actually varies as the Loudspeaker reproduces different frequencies. As a result, the nominal impedance rating of the Loudspeaker (usually measured at a midrange frequency) might not always agree with the impedance of the Loudspeaker at low frequencies where the greatest amount of power is required. Contact the Loudspeaker Manufacturer for additional information about the actual impedance of the Loudspeaker before connecting it to the McIntosh MC275.

4. The Ω is the symbol for the word ohms and refers to the impedance of the Output Terminals of the MC275.
5. When discarding the unit, comply with local rules or regulations. Batteries should never be thrown away or incinerated but disposed of in accordance with the local regulations concerning battery disposal.
6. For additional information on the MC275 and other McIntosh Products please visit the McIntosh Web Site at www.mcintosh-labs.com.



Connector and Cable Information

XLR Connectors

Below is the Pin configuration for the XLR Balanced Input, Input/Output Connectors on the MC275. Refer to the diagram for connection:

- PIN 1: Shield/Ground
- PIN 2: + Output
- PIN 3: - Output

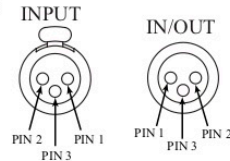

Power Control Connector

The MC275 Power Control Input receives an On/Off signal from +5 to +12 volts. The Power Control Output will in turn provide a +12 volt Output Signal with a current up to 20mA. An additional connection is for controlling the green illumination of the MC275 Small Signal Tubes when connected to a compatible McIntosh Preamplifier or A/V Control Center Power Control Output. The 1/8 inch stereo mini phone plug connects to a McIntosh Preamplifier or A/V Control Center Power Control Output.

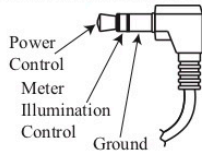

Note: When it is desired to switch Off the green illumination of the Small Signal Tubes, and the MC275 is not connected to a McIntosh McIntosh Preamplifier or A/V Control Center with meter illumination control, connect a 1/8 inch Mono mini phone plug to the POWER CONTROL IN jack.

Introduction

Now you can take advantage of traditional McIntosh standards of excellence in the MC275 Tube Power Amplifier. The 75 watt power output per channel will drive any high quality Loudspeaker System. The MC275 reproduction is sonically transparent and absolutely accurate. The McIntosh Sound is "The Sound of the Music Itself."

Performance Features

• Power Output

The MC275 is a Tube Power Amplifier with a capability of 75 watts per channel into 4, 8 or 16 ohm Loudspeakers with less than 0.5% distortion. It may also be operated in mono at 150 watts into 2, 4, or 8 ohm Loudspeaker.

• Unity Coupled Circuitry

The MC275 Power Amplifier uses the famous McIntosh Patented Unity Coupled Circuit which provides low distortion, extended frequency response and cool operating output tubes.

• Multifilar Wound Output Transformer

The MC275 Output Transformer Windings are part of the Unity Coupled Circuitry. There are two bifilar wound primaries, one for the cathodes and one for the plates. The secondary winding is wound together with the primary windings. This provides very close primary to secondary coupling. The result is flat frequency response and wide power bandwidth.

• Balanced and Unbalanced Input

Balanced connections guard against induced noise and allow long cable runs without compromising sound quality.

• Sentry Monitor Tube Protection

McIntosh Sentry Monitor Tube Protection Circuits ensure the MC275 will have a long and trouble free operating life.

• Gold Plated Connectors and Tube Socket Contacts

Gold Plated Input Jacks and Output Binding Posts provide trouble free connections. Ceramic tube sockets with gold plated contacts provide protection from atmospheric contamination. Output Tube Sockets include Air-Pipe cooling at their bases.

• Custom Gold Plated Jumper Bars

To facilitate the MC275 Power Amplifier Monaural Parallel Mode of Operation, there are two Custom Designed Gold Plated Jumper Bars included. These bars provide maximum power transfer and ease of connection to the Output Binding Posts.

• Special Power Supply

A regulated Power Supply, a very large core Power Transformer and large capacitors ensure stable noise free operation even though the power line varies.

• LED Tube Illumination

Tri-Color LEDs illuminate the small signal processing tubes of the MC275. They indicate tube warm up, normal and sentry monitor modes of operation.

• Titanium Chassis with Super Mirror Finish

The famous McIntosh Stainless Steel Chassis with Super Mirror Finish ensures the pristine beauty of the MC275 will be retained for many years.



Dimensions

The following dimensions can assist in determining the best location for your MC275.

Front View of the MC275

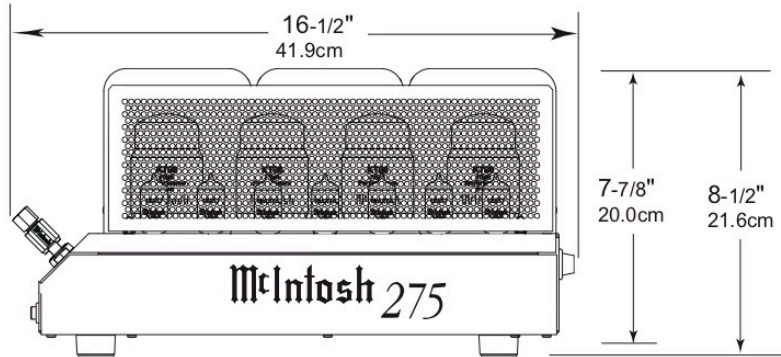

Left Side View of the MC275

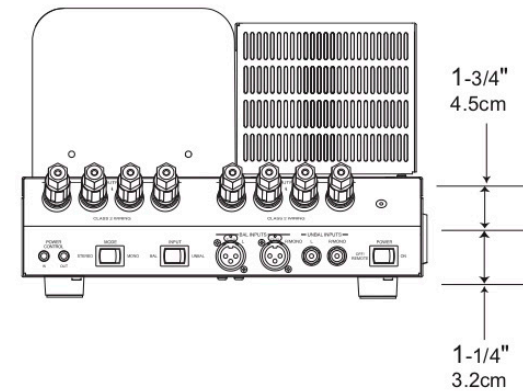

Top View of the MC275

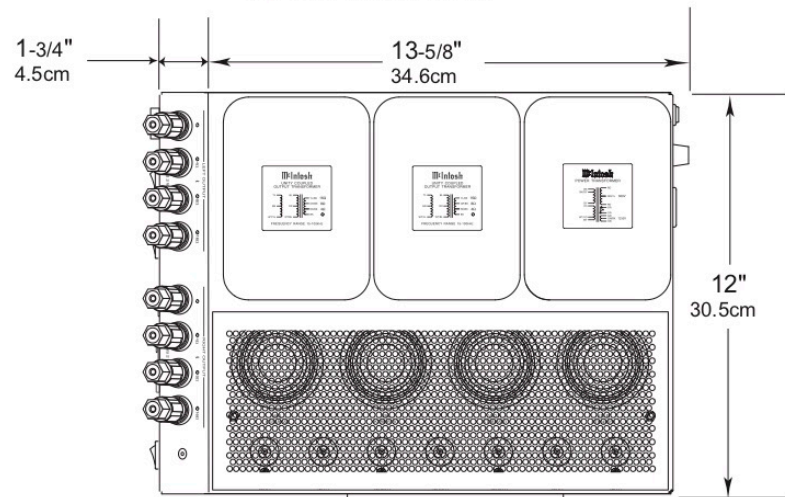

Right Side View of the MC275

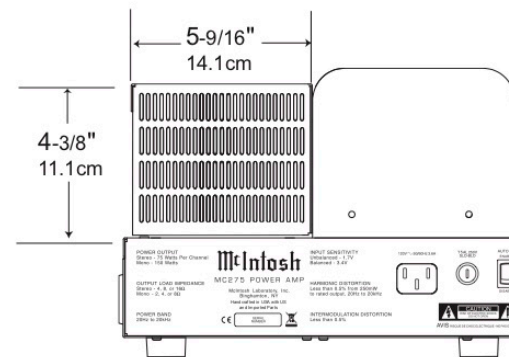

Left Side Connections, Indicator and Switch; Right Side Connection, Fuse Holder and Switch

LEFT OUTPUT
Connections for
a 4, 8 or 16 ohm
Loudspeaker

BALANCED INPUTS for
audio cables from a Preamplifier
or A/V Control Center
audio output

RIGHT OUTPUT
Connections for
a 4, 8 or 16 ohm
Loudspeaker

UNBALANCED INPUTS
for audio cables from a
Preamplifier or A/V Control
Center audio output

Connect the MC275
power cord to a live AC
outlet. Refer to the no-
menclature above this
AC Socket to determine
the correct voltage

AUTO OFF Disables
or Enables the Power
Saving Circuitry¹

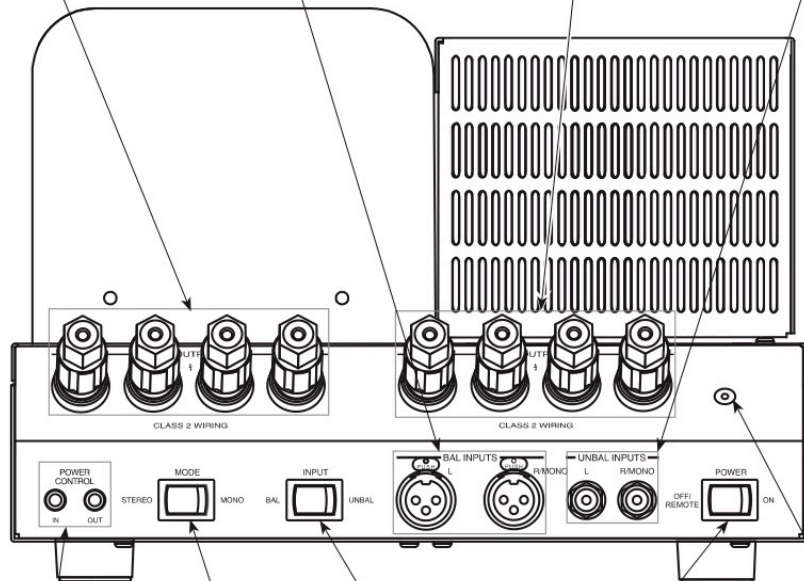

MODE switch selects between
STEREO and MONO Parallel
modes of operation

POWER Switch Turns
AC Power On or Off/
Remote (On/Off)

POWER CONTROL IN receives a turn On/Off
signal from a McIntosh component
POWER CONTROL OUT sends a turn On/Off
signal to the next McIntosh Component

INPUT switch selects
between BALANCED
and UNBALANCED
Input connections

Standby Power
On Indicator

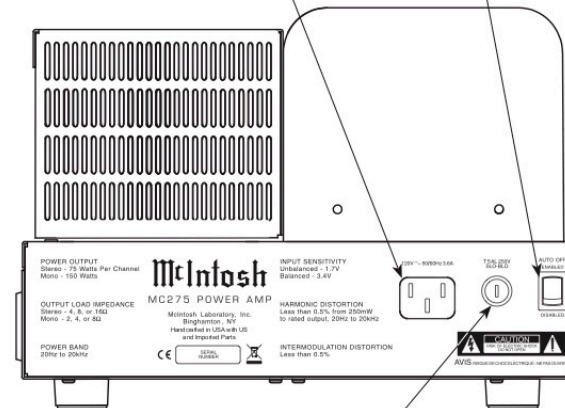

Fuse holder, refer to the nomenclature
above this fuse holder to determine the
correct the correct fuse size and rating

¹ Refer to page 15 for additional information



Output Terminals

When connecting the Loudspeaker Hookup Cables to the MC275 Power Amplifier Output Terminals please follow the steps below:

1. Rotate the top of the Output Terminal Post counterclockwise until an opening appears. Refer to figures A and B.
2. Insert the Loudspeaker hookup cable into the Output Terminal Post opening or the cable spade lug around the center post of the Output Terminal. Refer to figure C.
3. Rotate the top of the Output Terminal Post clockwise until it is finger tight. Refer to figure D.
4. Place the supplied McIntosh Wrench over the top of the Output Terminal and rotate it one quarter of a turn (90°) to secure the Loudspeaker Cable Connection. **Do not over tighten.** Refer to figure E.

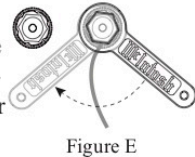
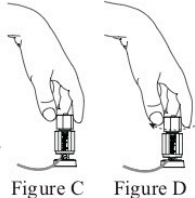
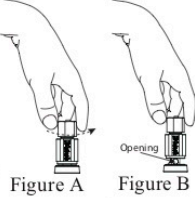

How to Connect for Stereo Operation

Caution: Do not connect the AC Power Cord to the MC275 Right Side Panel until after the Loudspeaker Connections are made. Failure to observe this could result in Electric Shock.

The connection instructions below, together with the MC275 Connection Diagram located on the separate folded sheet "McIA", is an example of a typical audio system. Your system may vary from this, however the actual components would be connected in a similar manner. For additional information refer to "Connector and Cable Information" on page 7.

1. For Remote Power Control, connect a power control cable from the Audio Preamplifier Power Control Main Output Jack to the Power Amplifier POWER CONTROL IN Jack.
2. Connect XLR cables from the Balanced Main Output connector of the Audio Preamplifier to the Power Amplifier BALANCED INPUTS. Place the INPUT Switch in the BALANCED Position.

Note: An optional hookup is to use unbalanced cable and place the INPUT MODE Switch in the UNBALANCED Position.

This McIntosh MC275 Power Amplifier is designed for Loudspeakers with an impedance of 4 ohms, 8 ohms or 16 ohms. Connect a single Loudspeaker only to the Output Terminals.

When connecting Loudspeakers to the MC275 it is very important to use cables of adequate size, so there is little to no power loss in the cables. The size is specified in Gauge Numbers or AWG (American Wire Gauge). The smaller the Gauge number, the larger the wire size:

Loudspeaker Cable Distance vs Wire Gauge Guide			
Loudspeaker Impedance	25 feet (7.62 meters) or less	50 feet (15.24 meters) or less	100 feet (30.48 meters) or less
4 Ohms	12AWG	10AWG	8AWG
8 Ohms	14AWG	12AWG	10AWG
16 Ohms	16AWG	14AWG	12AWG

3. Prepare the Loudspeaker Hookup Cable for attachment to the MC275 Power Amplifier:

Bare wire cable ends:

Carefully remove sufficient insulation from the cable ends, refer to figures 1, 2 & 3. If the cable is stranded, carefully twist the strands together as tightly as possible.

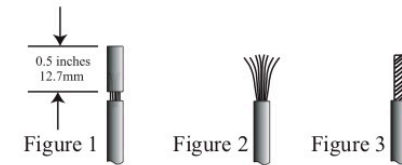

- Notes:*
1. If desired, the twisted ends can be tinned with solder to keep the strands together.
 2. The prepared bare wire cable ends may be inserted into spade lug connectors.
 3. Banana plugs are for use in the United States and Canada only.

Banana Plugs are for use in the United States and Canada only:

4. Attach the previously prepared bare wire cable ends into the banana plugs and secure the connections. Refer to figure F.
5. Rotate the top of the Output Terminal Post clockwise until it is finger tight. Refer to figure G. Then using the McIntosh Wrench, rotate the top of the Output Terminal one quarter of a turn (90°). **Do not over tighten.** Refer to figure E.
6. Referring to figure H, connect the Loudspeaker hookup cables with banana plugs into the hole at the top of the MC275 Negative (-) and Positive Output (+) Terminals. The Positive Terminals are identified as 4Ω (ohms), 8Ω (ohms) or 16Ω

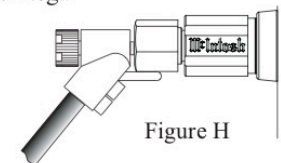
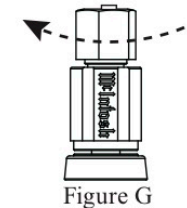
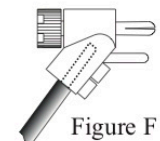

(ohms) connection to match the impedance of the Loudspeaker, being careful to observe the correct polarities.

If the Loudspeaker's impedance is in-between the available connections, use the nearest lower impedance connection. Refer to "General Information" Note 3 on page 6 for additional information.

WARNING: Loudspeaker Terminals are hazardous live and present a risk of electric shock. For additional instruction on making Loudspeaker Connections contact your McIntosh Dealer or McIntosh Technical Support.

7. Connect the MC275 Power Cord to an active AC outlet.

Spade Lug or Wire Connections:

8. Connect the Loudspeaker hookup cables to the MC275 Negative Output Terminal (-) and Positive Output (+) Terminal identified as 4Ω (ohms), 8Ω (ohms) or 16Ω (ohms) connection to match the impedance of the Loudspeaker, being careful to observe the correct polarities. Insert the spade lug connector or prepared section of the cable end into the terminal side access hole, and tighten the terminal cap until the cable is firmly clamped into the terminals so the lugs or wire cannot slip out. **Do not over tighten.** Refer to figures 4, 5 and figure E.

Note: Refer to "Output Terminals" step 4 on page 10 for important information.

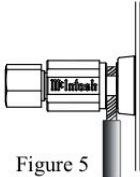
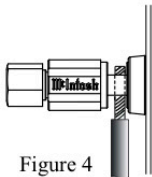

If the Loudspeaker's impedance is in-between the available connections, use the nearest lower impedance connection. Refer to "General Information" Note 3 on page 6 for additional information.

WARNING: Loudspeaker terminals are hazardous live and present a risk of electric shock. For additional instruction on making Loudspeaker Connections contact your McIntosh Dealer or McIntosh Technical Support.

9. Connect the MC275 Power Cord to an active AC outlet.





Output Terminals

When connecting the Loudspeaker Hookup Cables to the MC275 Power Amplifier Output Terminals please follow the steps below:

1. Rotate the top of the Output Terminal Post counterclockwise until an opening appears. Refer to figures A and B.

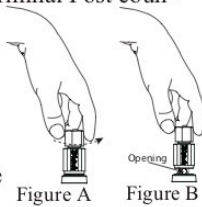

2. Insert the Loudspeaker hookup cable into the Output Terminal Post opening or the cable spade lug around the center post of the Output Terminal. Refer to figure C.

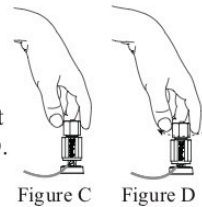

3. Rotate the top of the Output Terminal Post clockwise until it is finger tight. Refer to figure D.
4. Place the supplied McIntosh Wrench over the top of the Output Terminal and rotate it one quarter of a turn (90°) to secure the Loudspeaker Cable Connection. **Do not over tighten.** Refer to figure E.

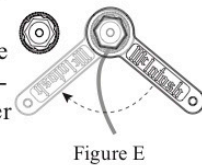

How to Connect for Monaural Operation

Caution: Do not connect the AC Power Cord to the MC275 Right Side Panel until after the Loudspeaker Connections are made. Failure to observe this could result in Electric Shock.

The following information is applicable to audio systems using more than one MC275. This would include a stereo system where one MC275 Power Amplifiers operating in Mono Mode for the Right Channel and another MC275 for the Left Channel.

The following connection instructions, together with the MC275 Connection Diagram located on the separate folded sheet “Mc1B”, illustrates the con-

nections for the Left Channel. The connections also applies to a second MC275 Power Amplifier for the Right Channel.

Your system may vary from this, however the actual components would be connected in a similar manner. For additional information refer to “Connector and Cable Information” on page 7.

1. For Remote Power Control, connect a power control cable from the Audio Preamplifier Power Control Main Output Jack to the first MC275 Power Amplifier POWER CONTROL IN Jack.
2. Connect a second Power Control Cable from the POWER CONTROL Output of the first MC275 to the second MC275 Power Amplifier POWER CONTROL IN Jack.
3. Connect an XLR cable from the Balanced Main Output Left Channel connector of the Audio Preamplifier to the first MC275 Power Amplifier BALANCED INPUT R/MONO. Place the INPUT Switch in the BALANCED position and the MODE Switch in the MONO position.

Notes: 1. An optional hookup is to use an unbalanced cable and place the INPUT MODE Switch in the UNBALANCED Position.

2. When multiple MC275s are used in a Stereo System, match up the Preamplifier Channel Output designation to each MC275 with the Loudspeaker location in the room.

4. Connect an XLR cable from the Balanced Main Output Right Channel connector of the Audio Preamplifier to the second MC275 Power Amplifier BALANCED INPUT R/MONO.

The McIntosh MC275 Power Amplifier in MONO Mode is designed for Loudspeakers with an impedance of 2 ohms, 4 ohms or 8 ohms. Connect a single Loudspeaker only to the Output Terminals.

When connecting Loudspeakers to the MC275 it is very important to use cables of adequate size, so there is little to no power loss in the cables. The size is specified in Gauge Numbers or AWG (American Wire Gauge). The smaller the Gauge number, the larger the wire size:

Loudspeaker Cable Distance vs Wire Gauge Guide			
Loudspeaker Impedance	25 feet (7.62 meters) or less	50 feet (15.24 meters) or less	100 feet (30.48 meters) or less
2 Ohms	12AWG	10AWG	8AWG
4 Ohms	14AWG	12AWG	10AWG
8 Ohms	16AWG	14AWG	12AWG

5. Prepare the Loudspeaker Hookup Cables for attachment to the MC275 Power Amplifier.

Bare wire cable ends:

Carefully remove sufficient insulation from the cable ends, refer to figures 1, 2 & 3. If the cable is stranded, carefully twist the strands together as tightly as possible.

- Notes: 1. If desired, the twisted ends can be tinned with solder to keep the strands together.*
2. The prepared bare wire cable ends may be inserted into spade lug connectors.
 3. Banana plugs are for use in the United States and Canada only.

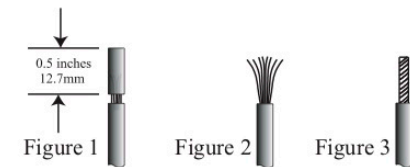

Banana Plugs are for use in the United States and Canada only:

6. Attach the previously prepared bare wire cable ends into the banana plugs and secure the connections. Refer to figure F.
7. For the MC275 MONO Mode of operation, use the supplied Jumper Bars to connect the Output of the Left and Right Amplifier Channels in parallel.

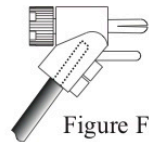

Figure F

Insert a Jumper Bar into the terminal side access hole of the LEFT OUTPUT (-) Negative Terminal post and the other end of the Jumper Bar into the RIGHT OUTPUT (-) Negative Terminal post. Tighten the terminal caps until the Jumper Bar is firmly clamped into the terminals so the Jumper Bar cannot slip out nor touch the chassis. Refer to Connection Diagram located on the separate folded sheet “Mc1B”.

8. In a similar manner, connect the other Jumper Bar between the two (+) Positive 16Ω Output Terminals for connecting a 8Ω (ohm) Loudspeaker (or between the 8Ω Terminals for a 4Ω (ohm) Loudspeaker, or between the 4Ω Terminals for a 2Ω (ohm) Loudspeaker). It is important to match the impedance of the Loudspeaker, being careful to observe the correct polarities. If the Loudspeaker’s impedance is in-between the available connections, use the nearest lower impedance connection. Refer to “General Information” Note 3 on page 6 for additional information.

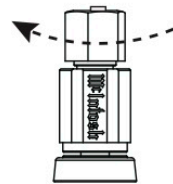

Figure G

9. Rotate the top of the Output Terminal Posts clockwise until they are all finger tight. Refer to figure G. Then using the

McIntosh Wrench, rotate the top of the Output Terminal one quarter of a turn (90°). **Do not over-tighten.** Refer to figure E.

10. Referring to figure H, connect the Loudspeaker hookup cables with banana plugs into the hole at the top of the MC275 LEFT OUTPUT Negative (-) Terminal and the Positive Output (+) Terminal (which has the previously installed Jumper Bars).

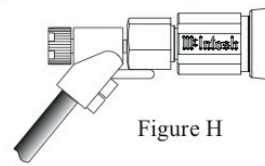

Figure H

WARNING: Loudspeaker Terminals are hazardous live and present a risk of electric shock. For additional instruction on making Loudspeaker Connections contact your McIntosh Dealer or McIntosh Technical Support.

11. Connect the MC275 Power Cord to an active AC outlet.

Spade Lug or Wire Connections:

12. For the MC275 MONO Mode of operation, use the supplied Jumper Bars for connecting the Output of the Left and Right Amplifier Channels in parallel. Insert the Jumper Bar into the terminal side access hole of the LEFT OUTPUT (-) Negative Terminal post and the other end of the Jumper Bar into the RIGHT OUTPUT (-) Negative Terminal post. Tighten the terminal caps until the Jumper Bar is firmly clamped into the terminals so the Jumper Bar cannot slip out nor touch the chassis. Refer to Connection Diagram located on the separate folded sheet “Mc1B”. Also refer to figures 4, 5 and figure E.

Note: Refer to “Output Terminals” step 4 on page 12 for important information.

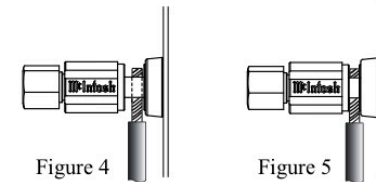

Figure 4

Figure 5

13. In a similar manner, connect the other Jumper Bar between the two (+) Positive 16Ω Output Terminals for connecting a 8Ω (ohm) Loudspeaker (or between the 8Ω Terminals for a 4Ω (ohm) Loudspeaker, or between the 4Ω Terminals for a 2Ω (ohm) Loudspeaker). It is important to match the impedance of the Loudspeaker, being careful to observe the correct polarities. If the Loudspeaker’s impedance is in-between the available connections, use the nearest lower impedance connection. Refer to “General Information” Note 3 on page 6 for additional information.
14. Connect the Loudspeaker hookup cables to the MC275 LEFT OUTPUT Negative (-) Terminal and Positive Output (+) Terminal (which has the previously installed Jumper Bars).

WARNING: Loudspeaker terminals are hazardous live and present a risk of electric shock. For additional instruction on making Loudspeaker Connections contact your McIntosh Dealer or McIntosh Technical Support.
15. Connect the MC275 Power Cord to an active AC outlet.



Right Side Switch, Left Side Switches and Indicators

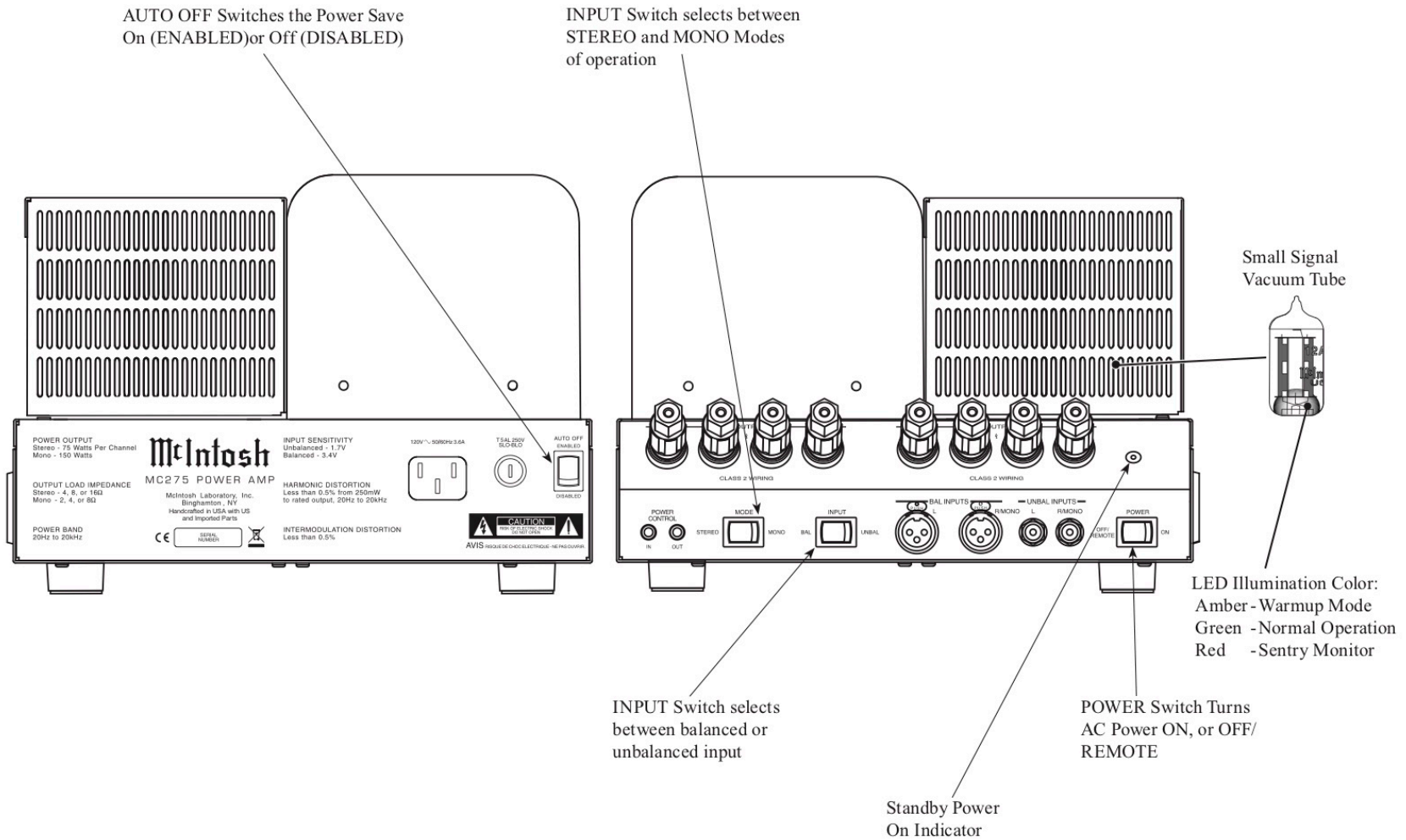

How to Operate

Power

With the POWER Switch (located on the Left Side of the MC275) set to the OFF/REMOTE Position, the MC275 will turn On or Off when the Preamplifier turns On or Off. For manual operation, place the POWER Switch to the ON Position as desired. Refer to figure 10. The LED indicator located above the Power Switch is illuminated when the MC275 is connected to an active AC Outlet. Refer to figure 11.

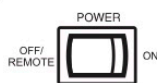

Figure 10



Figure 11

- Notes: 1. There must be a power control connection between the MC275 and the McIntosh Preamplifier in order for the remote power turn-on to function.
2. To switch the MC275 back On after the Auto Sense Circuitry has placed the amplifier into the Standby Mode, it is first necessary to place the POWER Switch in the OFF/REMOTE position. Then place the POWER Switch in the ON position. Refer to "Auto Off Switch" below for additional information.
3. When the MC275 is first switched On, there is a Warm-Up period of time during which no sound will be heard; there is also sequential illumination (amber color) of the Small Signal Vacuum Tubes. After the Warm-Up period of time, sound will be heard and the illumination color of the Small Signal Vacuum Tubes will change to green.

Auto Off Switch

The MC275 incorporates Power Save Circuitry to automatically place the MC275 into the power saving Standby Mode approximately 30 minutes after there has been an absence of an audio input signal.

When there is a Power Control Connection between the MC275 and a Preamplifier with Power Save Circuitry, the AUTO OFF Switch is bypassed (located on the Right Side Of the MC275). Refer to figure 12.

In the event there is no Power Control Connection and the Power Save Circuitry is activating inappropriately relative to your specific use of the MC275, place the AUTO OFF Switch in the DISABLE position.

Note: If the Power Save Circuitry has switched Power to the MC275 OFF, place the POWER in the OFF Position and then in the ON position to reset the circuitry.



Figure 12

Input Switch

The Input Switch (located on the Left Side of the MC275) allows you to select either the BAL (Balanced) or UNBAL (Unbalanced) Input. Refer to figure 13.

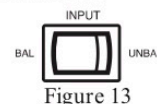

Figure 13

Mode Switch

The MODE Switch (located on the Left Side of the MC275) allows selection of either Stereo or Mono (Parallel) Modes of Operation. Refer to figure 14 and pages 10 thru 13 for connection information.

With the MODE Switch placed in the STEREO position the MC275 is capable of delivering over 75 watts per channel (Left and Right) into a Loudspeaker with an impedance¹ of 4 Ω, 8 Ω or 16 Ω.

When the MODE Switch is placed in the MONO position, the MC275 operates in a Single Channel Mono Parallel Mode and is capable of delivering over

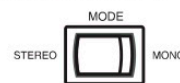

Figure 14

150 watts into a Loudspeaker with an impedance¹ of 2 Ω, 4 Ω or 8 Ω.

Sentry Monitor

The MC275 Sentry Monitor Tube Protection Circuitry provides protection to the Power Amplifier in the event of an impedance mismatch¹ between the MC275 and the Loudspeaker(s). It will also activate if there is a short circuit at the MC275 Output Terminals (or the Loudspeaker Terminals) or if a MC275 Power Output Tube should fail. During normal operation the Sentry Monitor Tube Protection Circuitry has no effect on the performance of the Power Amplifier.

In the event a problem occurs, the circuitry will activate to prevent potentially destructive high levels of current from flowing in the amplifier. The illumination color of the Small Signal Vacuum Tubes of the affected channel will change from green to red. To reset the Sentry Monitor Tube Protection Circuitry first note the position of the POWER Switch. If the POWER Switch is set to the OFF/REMOTE position, switch Off the Preamplifier for approximately one minute and then switch the Preamplifier On. When the POWER Switch set to the ON position, place the POWER Switch to the OFF/REMOTE for approximately one minute, then place the POWER Switch to the ON position.

¹ The impedance of a Loudspeaker actually varies as the Loudspeaker reproduces different frequencies. As a result, the nominal impedance rating of the Loudspeaker (usually measured at a midrange frequency) might not always agree with the impedance of the Loudspeaker at low frequencies where the greatest amount of power is required. Contact the Loudspeaker Manufacturer for additional information about the actual impedance of the Loudspeaker before connecting it to the McIntosh MC275.







Specifications

Power Output Stereo

Minimum sine wave continuous average power output per channel, both channels operating is:

75 watts into 4 ohm loads

75 watts into 8 ohm loads

75 watts into 16 ohm loads

Power Output Mono (Parallel)

Minimum sine wave continuous average power output is:

150 watts into 2 ohm load

150 watts into 4 ohm load

150 watts into 8 ohm load

Output Load Impedance

4, 8 or 16 ohms (Stereo Mode)

2, 4 or 8 ohms (Mono Mode)

Rated Power Band

20Hz to 20,000Hz

Total Harmonic Distortion

0.5% maximum harmonic distortion at any power level from 250 milliwatts to rated power, 20Hz to 20,000Hz

Frequency Response

+0, -0.5dB from 20Hz to 20,000Hz

+0, -3.0dB from 10Hz to 100,000Hz

Input Sensitivity (for rated output)

1.7 Volts Unbalanced

3.4 Volts Balanced

Signal To Noise Ratio (A-Weighted)

105dB below rated output

Intermodulation Distortion

0.5% maximum, if the instantaneous peak power output does not exceed twice the rated power output for any combination of frequencies from 20Hz to 20,000Hz.

Wide Band Damping Factor

Greater than 22

Input Impedance

47,000 ohms Unbalanced

20,000 ohms Balanced

Tube Compliment

3 - 12AX7A Input and Phase Inverter

4 - 12AT7 Voltage Amplifier and Driver

4 - KT88/6550 Power Output

Power Requirements

Field AC Voltage conversion of the MC275 is not possible. The MC275 is factory configured for one of the following AC Voltages:

100V ~ 50/60Hz at 4.4 Amps

110V ~ 50/60Hz at 3.6 Amps

120V ~ 50/60Hz at 3.6 Amps

220V ~ 50/60Hz at 2.0 Amps

230V ~ 50/60Hz at 1.8 Amps

240V ~ 50/60Hz at 1.8 Amps

Standby: Less than 0.3 watts

Note: Refer to the right side panel of the MC275 for the correct voltage.

Overall Dimensions

Width is 21-1/2 inches (54.6cm) including Cables

Height is 8-1/2 inches (21.6cm) including feet

Depth is 12 inches (30.5cm)

Weight

67 pounds (30.5 kg) net, 75 pounds (34.1 kg) in shipping carton

Shipping Carton Dimensions

Width is 22 inches (55.9cm)

Height is 14 inches (35.6cm)

Depth is 16-3/4 inches (42.6cm)

Packing Instructions

In the event it is necessary to repack the equipment for shipment, the equipment must be packed exactly as shown below. It is very important that the four feet are attached to the bottom of the equipment. This will ensure the proper equipment location on the bottom foam pad. Failure to do this will result in shipping damage.

To protect the tubes during shipment, the Foam Insert removed from the MC275 needs to be re-inserted. Follow the unpacking instructions on pages 4-5 in the reverse order.

Use the original shipping carton and interior parts only if they are all in good serviceable condition. If a shipping carton or any of the interior part(s) are needed, please call or write Customer Service Department of McIntosh Laboratory, refer to page 3. Please see the Part List for the correct part numbers.

Quantity	Part Number	Description
1	034529	Shipping carton
1	034526	Foam Pad Top
2	034527	Foam Pad Bottom
1	034528	Foam Insert (for protecting the Tubes during shipping)
1	041314	Warning Sheet
4	400131	10-32 x 1/2 inch screw
4	163073	Feet

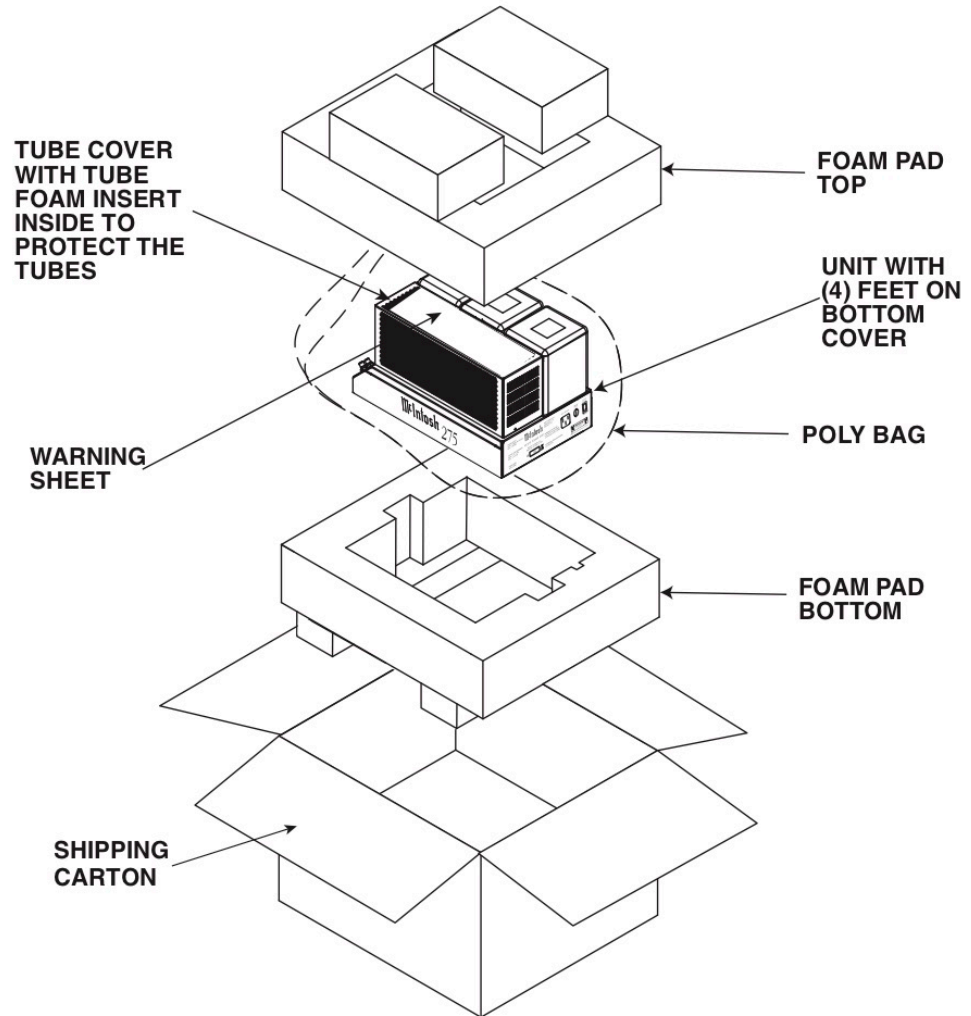



McIntosh Laboratory, Inc.
2 Chambers Street
Binghamton, NY 13903
www.mcintoshlabs.com

The continuous improvement of its products is the policy of McIntosh Laboratory Incorporated who reserve the right to improve design without notice.
Printed in the U.S.A.

McIntosh Part No. 04132700