

**Model 120
FM/AM Stereophonic
Tuner**

Handbook of instructions

© 1964 Philips North America, Inc.

Philips

TABLE OF CONTENTS

Preparation for Use	2
Rear Panel Connections	2
Output Jacks	2
Tape Out Jacks	2
Quadradiial Jack	3
FM Antenna	3
Antenna Attenuator	4
AM Antenna	4
Power Connections	4
Connection to AC Outlet	4
Convenience Outlet	4
Simplified Operating Procedure	4
Scope Display	5
Centering of the Scope Display	5
Tuning Display	5
FM Tuning Display	5
AM Tuning Display	5
FM Multipath Indication	6
Audio Display Switch	7
External Audio Display Switch	7
Mono Switch	7
Muting Switch and Muting Level Control	7
Hi Blend Switch	8
Functional Description	8
FM Front End	8
FM IF Amplifier	9
FM Stereo Demodulator	9
Muting Circuit	10
Scope Display Circuit	10
Focus, Brightness, and Centering	
Adjustments	10
AM Tuner	10
Technical Descriptions	11
Service Notes	12

LIST OF ILLUSTRATIONS

1. Rear Panel Connection Facilities and Adjustments	2
2. Connection of Tuner and Amplifier	2
3. To make a recording depress selection switch to be desired program source and put the recorder into the record mode of operation	3
4. FM/AM Antenna Connection	3
5. AM Ferrite-rod Antenna	4
6. Centering of Scope	5
7. FM Tuning Display	5
8. AM Tuning Display	6
9. FM Broadcast Modulation Characteristics	6
10. Adjusting Antenna Direction	6
11. Audio Display	7
12. Connection for External Audio Display	7
13. Front Panel	8
14. Functional Block Diagram	9
15. FM Characteristics	10
16. Stereo Separation	10
17. Packing Instructions	12

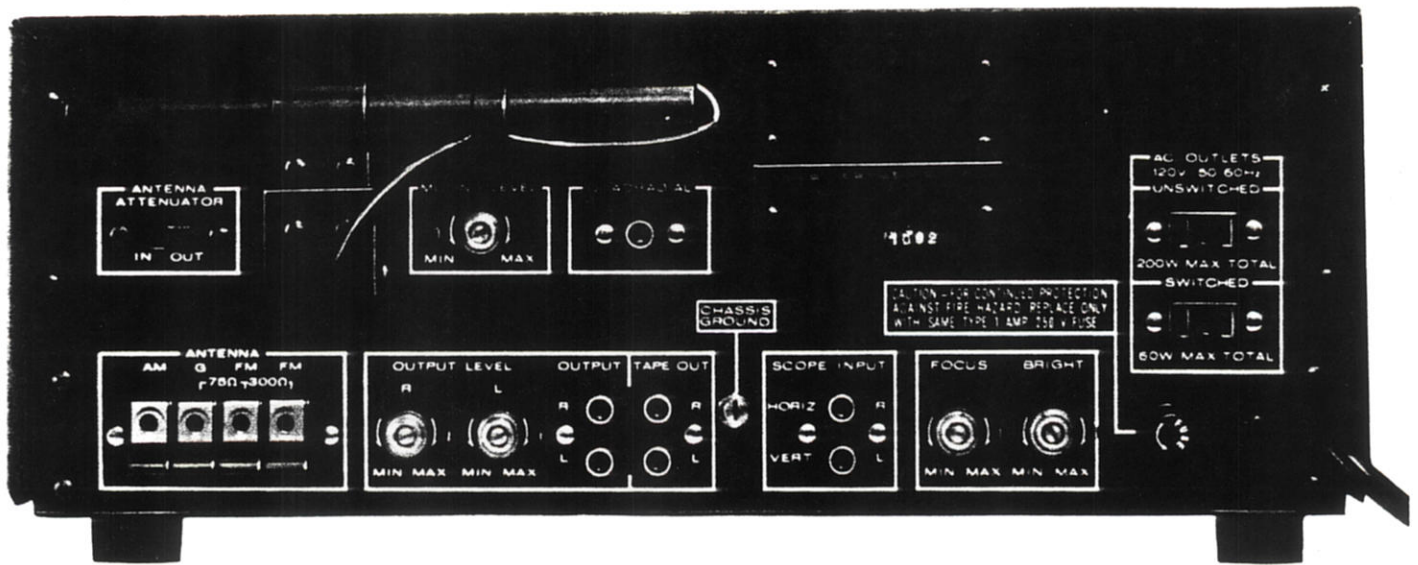

Figure 1. Rear Panel Connection Facilities and Adjustments

PREPARATION FOR USE

REAR PANEL CONNECTIONS

All signal connections to the Model 120, with the exception of the FM antenna, should be made with shielded audio cables. Figure 1 shows the location of input and output jacks on the rear panel. These jacks are for "permanent" connections. These connections are arranged in stereo pairs except for the QUADRADIAL jack and FM antenna connections. To avoid confusion, connect one cable at a time between the Model 120 and the your audio system. In this way, you will avoid cross-connecting channels or confusing signal sources with destinations.

OUTPUT Jacks

The signal output selected by the AM or FM pushswitch on the front panel is fed to the OUTPUT jacks. All output jacks are controlled by the MONO and HI BLEND pushswitches. Left and/or right output levels can be varied by rotating the corresponding OUTPUT LEVEL controls on the rear panel. Both output levels have been set at the factory for maximum output level, and may be decreased by turning the controls counterclockwise.

Connect "R" OUTPUT of the Model 120 to the "R" input of AUX or TUNER jacks of your audio amplifier. Next, connect "L" OUTPUT of the Model 120 to the "L" jack of your amplifier as shown in Figure 2.

TAPE OUT Jacks

Connecting these jacks to the line or radio inputs of a tape recorder permits recording from the program source selected by the FM or AM mode selection switch. To make tape recordings, see Figure 3.

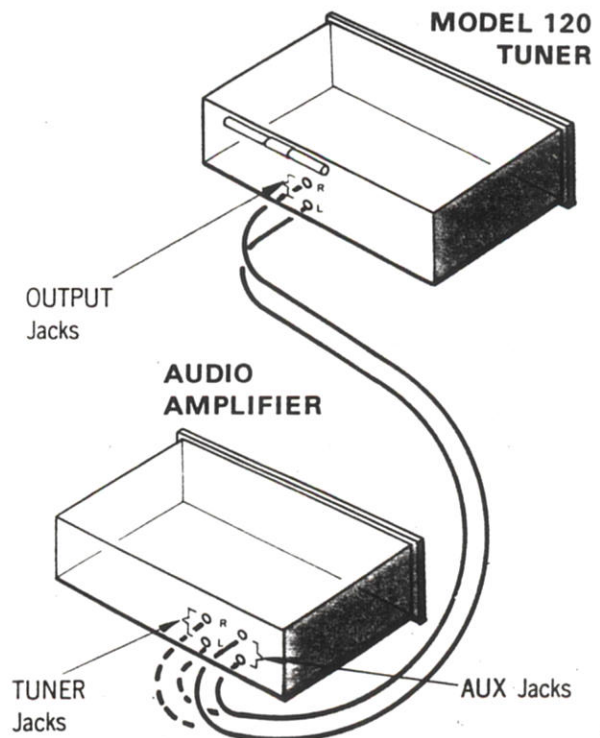

Figure 2. Connection of Tuner and Amplifier

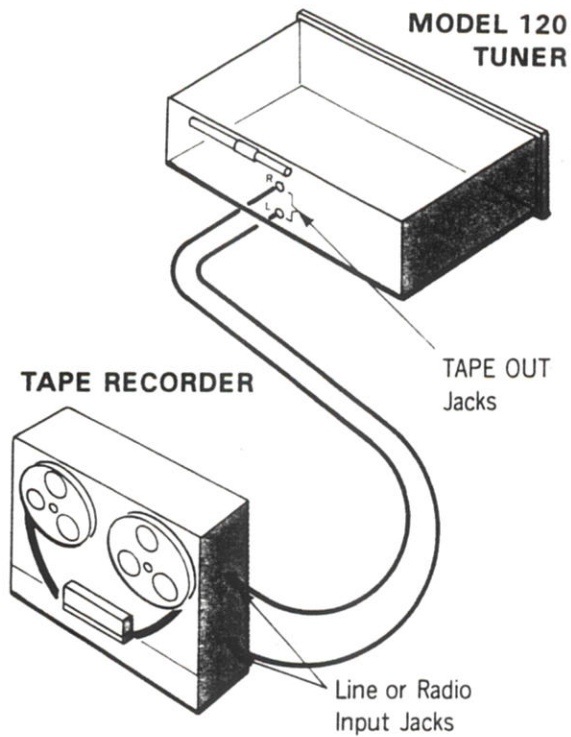

Figure 3. To make a recording depress selection switch to be desired program source and put the recorder into the record mode of operation

QUADRADIAL Jack

In anticipation of the coming of 4-channel stereo broadcasting, your Model 120 is equipped with an output **QUADRADIAL** jack. The signal available at this jack is the unequalized, buffered output of the FM discriminator. Its level, frequency response characteristics and FM output impedance are ideal to drive any 4-channel adaptor. This jack can also be used as a simple white noise generator for frequency response check of loudspeakers or amplifiers. For this application, use muting off the Model 120 in FM mode and tune off from any FM signal.

FM ANTENNA

The best FM reception is obtained with a Log-Periodic type antenna with a good rotor system. For fringe areas, Marantz recommends a Log-Periodic antenna with six or more elements designed expressly for FM reception. For minimum local noise and multipath pickup by the lead-in wires, use a balanced and shielded 300 ohm cable. (An unshielded lead-in wire can act as an omnidirectional antenna, and cancel the directional benefits of your antenna.) Low-loss 300 ohm

shielded cable consists of two inner conductors plus an outer shield and insulating jacket. This type of shielded cable effectively prevents the lead-in from contributing multipath distortion.

For rural areas, it is recommended that a local dealer be consulted about antenna installation and lightning arrestor protection. Master antenna system are not recommended for use with your Model 120. Such systems are usually designed expressly for television reception and frequently suppress FM signals before distribution. In addition, master antenna systems often severely limit good quality FM reception.

Where outdoor antennas are prohibited or inconvenient, use a simple form of 300 ohm, TV "rabbit ear" antenna or the simple ribbon-type folded dipole antenna supplied with the Model 120. Both are practical and will give satisfactory results in primary signal areas.

The Tuner will accept either a 75 ohm or 300 ohm antenna. (See diagram Figure 4.) The 300 ohm antenna cable should be connected to the two terminals marked **FM** on the **ANTENNA** terminal. When using 75 ohm coaxial antenna cable, connect its shield to the "**G**" (**G**ROUND) terminal, and its inner or center conductor to either of the **FM** terminals.

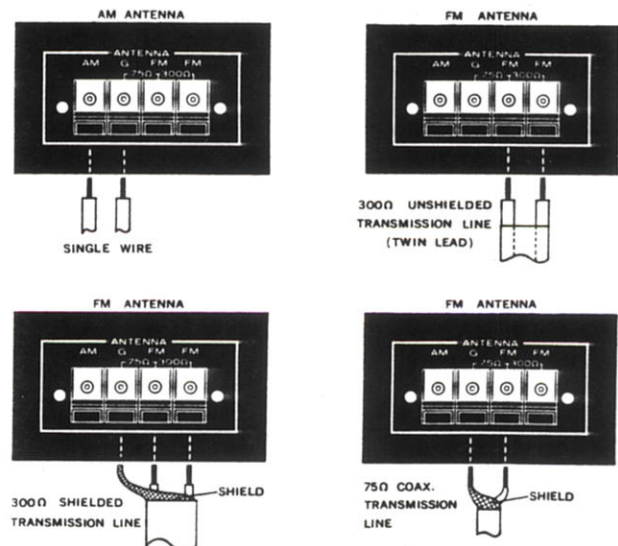

Figure 4. FM/AM Antenna Connection

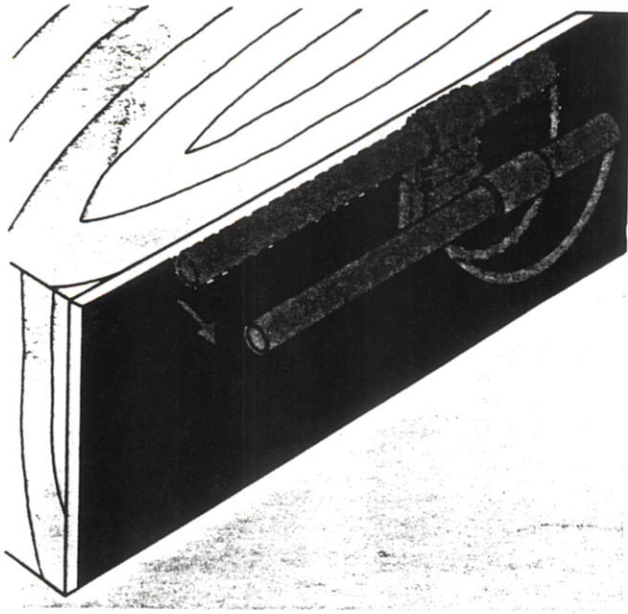

Figure 5. AM Ferrite-rod Antenna

ANTENNA ATTENUATOR

The **ANTENNA ATTENUATOR** can be switched into or out of the antenna circuit. Use the **ANTENNA ATTENUATOR** switch in the "IN" position only when overloading is apparent from reception of one station at several points of the dial and is affecting reception of a desired station. Overloading may also cause severe distortion which will not disappear with proper antenna orientation. (Note: With the **ANTENNA ATTENUATOR** switch "IN", the FM sensitivity and the number of stations that can be received are reduced.)

AM ANTENNA

Your Model 120 is equipped with an AM ferrite-rod antenna.

BEFORE USING THE MODEL 120, PULL THE ANTENNA OUT AS SHOWN IN FIGURE 5.

The ferrite-rod antenna will give satisfactory results in primary signal areas. However, an outdoor antenna will provide better reception. Two single wires are required to make an AM outdoor antenna. First, connect one end of a single wire to the **AM** antenna terminal on the rear panel, and place the other end at a very high position outdoors (the higher the better), or swing it from the window of your room. Next, connect the other single wire between the "G" (**GROUND**) terminal of your Model 120 and an earth ground (such as a water pipe).

POWER CONNECTIONS

The Model 120 is equipped with a universal power transformer to permit operation at any standard AC line voltage and at frequencies of 50 Hz to 60 Hz. For operation at line voltages other than indicated on the rear panel nameplate, have a qualified technician perform the simple wiring changes necessary.

CONNECTION TO AC OUTLET

With the front panel power pushswitch "out", plug the line cord into an electrical outlet supplying the proper voltage.

CAUTION: DO NOT PLUG YOUR MODEL 120 INTO A DC OUTLET, SINCE SERIOUS DAMAGE WILL OCCUR WHICH IS NOT COVERED BY OUR WARRANTY.

CONVENIENCE OUTLET

One **UNSWITCHED** and one **SWITCHED** AC outlet are provided on the rear panel for powering associated components of your system.

SIMPLIFIED OPERATING PROCEDURE

When operating the Model 120 Stereo Tuner for the first time, follow these simple directions. Later, full advantage can be taken of its versatility with the remaining control and pushswitches.

- Step 1. Connect the FM antenna to the appropriate terminals.
- Step 2. Connect both signal **OUTPUTS** to the **TUNER** (or **AUX**) input jacks of your amplifier as shown in Figure 2.
- Step 3. Place the selector or mode switch of your amplifier in the **TUNER** (or **AUX**) position.
- Step 4. Turn on the tuner power by depressing the power switch.
- Step 5. Set the **scope display** centering controls (under the scope) to the straight up (12 o'clock) position.
- Step 6. Select the desired program source by depressing the **AM** or **FM** pushswitch on the front panel. Rotate the "Gyro-Touch" **TUNING** knob until the desired station is tuned.

SCOPE DISPLAY

Important Notice

The scope display system is provided with an ON/OFF pushswitch.

Switch the display OFF when not in use to extend the life of the cathode ray tube (CRT).

Failure to turn the display OFF will shorten the CRT's life by causing the phosphor to become desensitized on the center portion of the display area.

—SUCH DAMAGE TO THE CRT IS NOT COVERED BY THE WARRANTY—

To operate the scope indicator, press in the front panel "ON" pushswitch.

CENTERING OF THE SCOPE DISPLAY

When the centering controls are rotated, the display will move vertically and horizontally. To correctly set these controls, proceed as follows:

- Step 1. Depress the "ON" and "EXTERNAL" scope display pushswitches. Note that the "scope trace" will be reduced to a very dim "dot" (if your tape recorder or any other audio equipment is connected to the "SCOPE INPUT" jacks on the rear panel, turn off the tape recorder or the other equipment during this adjustment.) Under ambient light conditions and/or low power line conditions, the "dot" may appear extremely dim. If necessary, shade the scope so that the "dot" can be seen during adjustment. (On the use of EXTERNAL scope and FOCUS and BRIGHTness controls, see page 10.)
- Step 2. Adjust the centering controls (VERT and HORIZ) to bring the "dot" into the center of the small circle as illustrated in Figure 6.

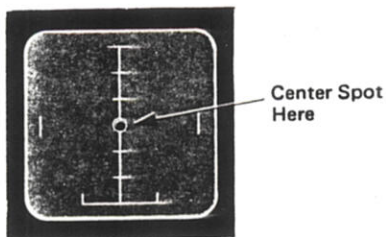
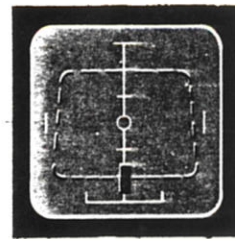
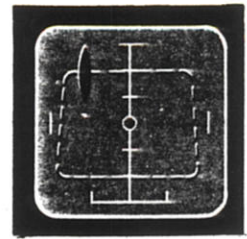

Figure 6. Centering of Scope



No Station Tuned



Off-Tune Left

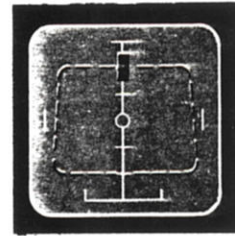

Correctly Tuned

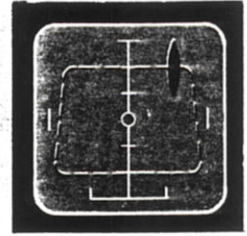

Off-Tune Right

Figure 7. FM Tuning Display

TUNING DISPLAY

FM Tuning Display

With both TUNING display and FM mode pushswitches depressed, a short vertical trace will appear in the lower center of the scope. As you tune past each station, this bright trace follows an approximately rectangular path as indicated in Figure 7.

For correct tuning, the trace should be centered on the upper portion of the scope as illustrated in Figure 7. Weak distant stations can be seen even when below the muting threshold. Orientation of the antenna will often increase the signal strength sufficiently to improve reception.

Signal strength is indicated by the relative displacement of the trace above the horizontal line. The vertical displacement is approximately logarithmic.

AM Tuning Display

With both TUNING display and AM mode pushswitches depressed a short horizontal trace will appear in the lower part of the scope. As you tune past each AM station, this trace will move up and down. For correct tuning, the trace should indicate the maximum vertical deflection.

FM MULTIPATH Indication

With both **MULTIPATH** display and **FM** mode selection switches depressed, the trace on the scope will indicate FM broadcast modulation and Multipath distortion characteristics.

FM modulation characteristics (without multipath distortion) are shown in Figure 9. If an FM station flagrantly over-modulates (grossly exceeds the 75 KHz deviation limits) an excessively long horizontal trace will result, with ends curling downwards outlining the top of the IF pass band characteristics of the tuner.

The trace on the scope will also indicate when the antenna is oriented to the best possible direction. A snake like or distorted trace (rather than the relatively smooth horizontal line shown in Figure 10),

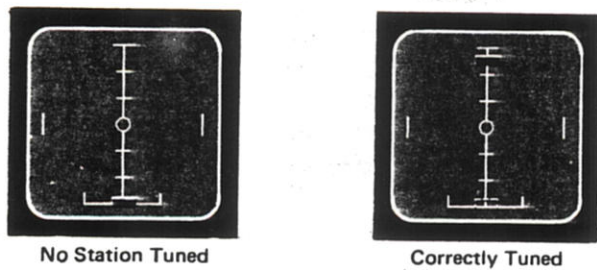

Figure 8. AM Tuning Display

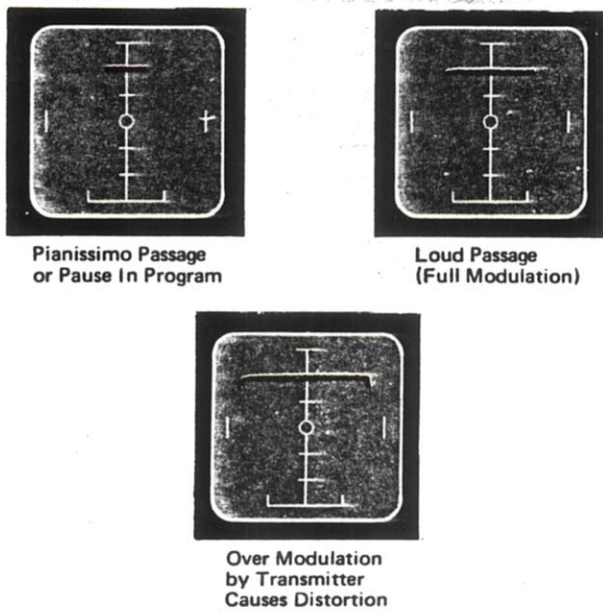

Figure 9. FM Broadcast Modulation Characteristics

indicates that the antenna is pointing in a direction unfavorable for good reception from the station. It shows the multipath reflections (identical to the ones that generate TV "ghosts") received along with the wanted signal. For best reception from each station, rotate the antenna to the direction giving the smoothest and most horizontal trace indication. This antenna orientation may not be the same as for the strongest signal (maximum vertical deflection). Thus "signal strength" or "center-of-channel" meters are not precise indicators for best quality signal reception.

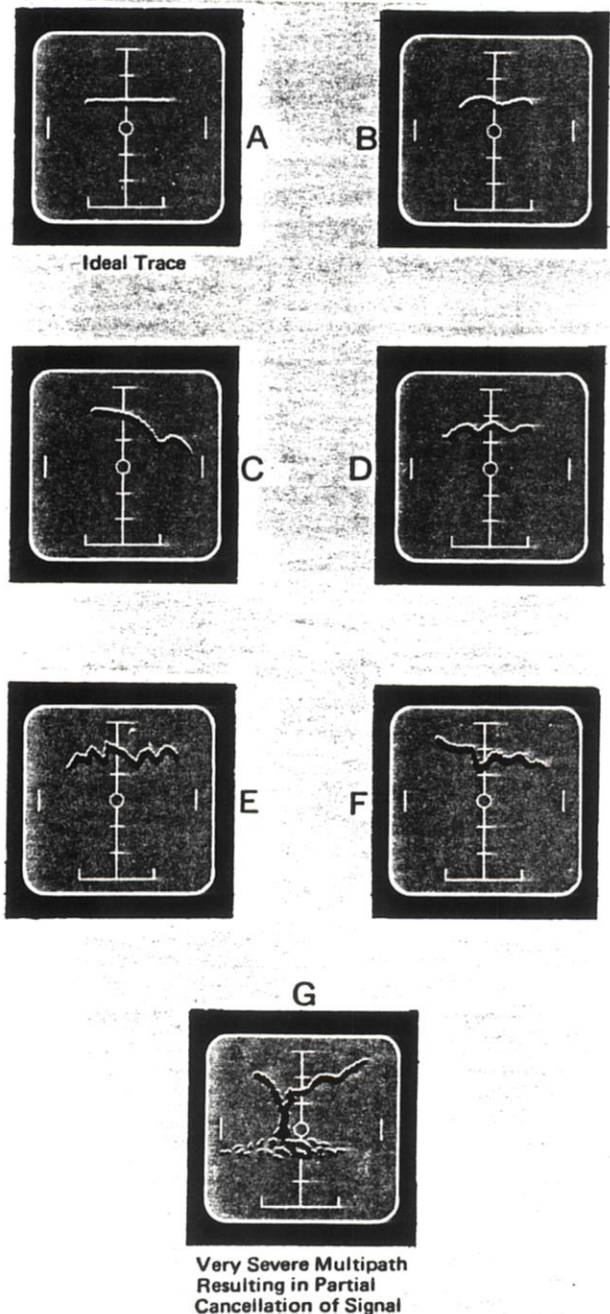

Figure 10. Adjusting Antenna Direction

The long gentle trace shape of illustration B is preferable to those of illustrations C through G and should yield good reception. In turn, trace illustrations C and D are preferred to E and F. Finally, G indicates very poor antenna orientation, causing signal cancellation and unacceptably noisy and distorted reception.

AUDIO Display Switch

Depressing the **AUDIO display** pushswitch connects the tuner outputs to the vertical and horizontal inputs of the display circuit.

In FM mode, the scope presents a stereo display of the left and right audio channels. This permits checking the channel separation and phasing of the program material. Typical trace pattern of audio display are shown in Figure 11. This display of Left and Right audio channel is an X-Y plot, or Lissajou figure. With the illustration shown in Figure 11, the user can visually analyze the program material.

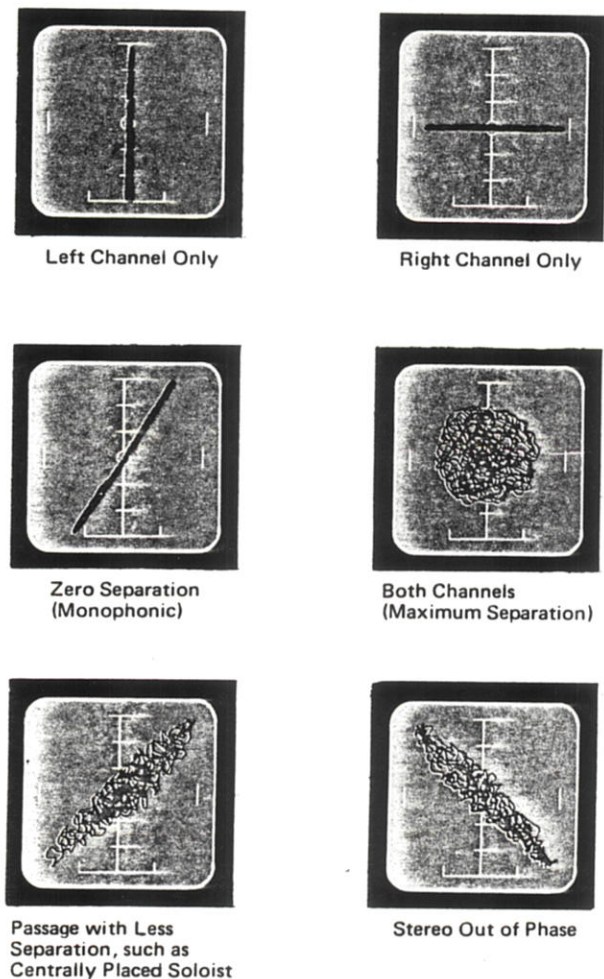

Figure 11. Audio Display

EXTERNAL Audio Display Switch

The test described above can also be performed with an external audio source (tape deck, preamp, etc), simply connect the Left and Right source outputs to the rear panel **SCOPE INPUT (HORIZ and VERT)** Jacks of your Model 120, and depress the **EXTERNAL scope display** pushswitch. The display will not be affected by any mode selection switches on the front panel. See Figure 12.

MONO Switch

Weak FM stereo signals sometimes cause noisy reception, when random noise phase modulation interferes with the multiplex decoding process.

This noise can be reduced appreciably by operating the FM tuner in the **MONO** mode.

Depressing the **MONO** pushswitch will convert all output signals to monophonic (Left plus Right), including signals at the **TAPE OUT** jacks.

MUTING Switch and MUTING LEVEL Control

In the absence of an FM carrier, any FM tuner will produce appreciable noise. This noise is apparent between stations while tuning.

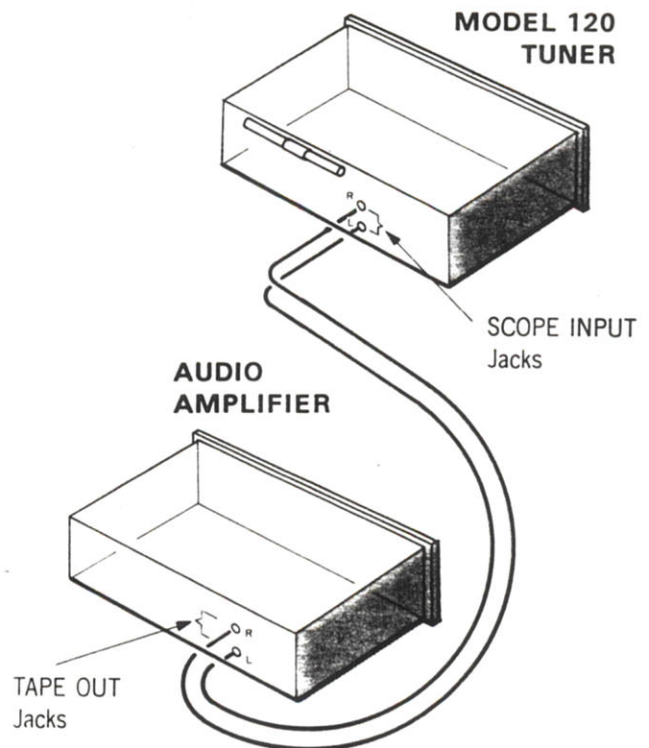

Figure 12. Connection for External Audio Display

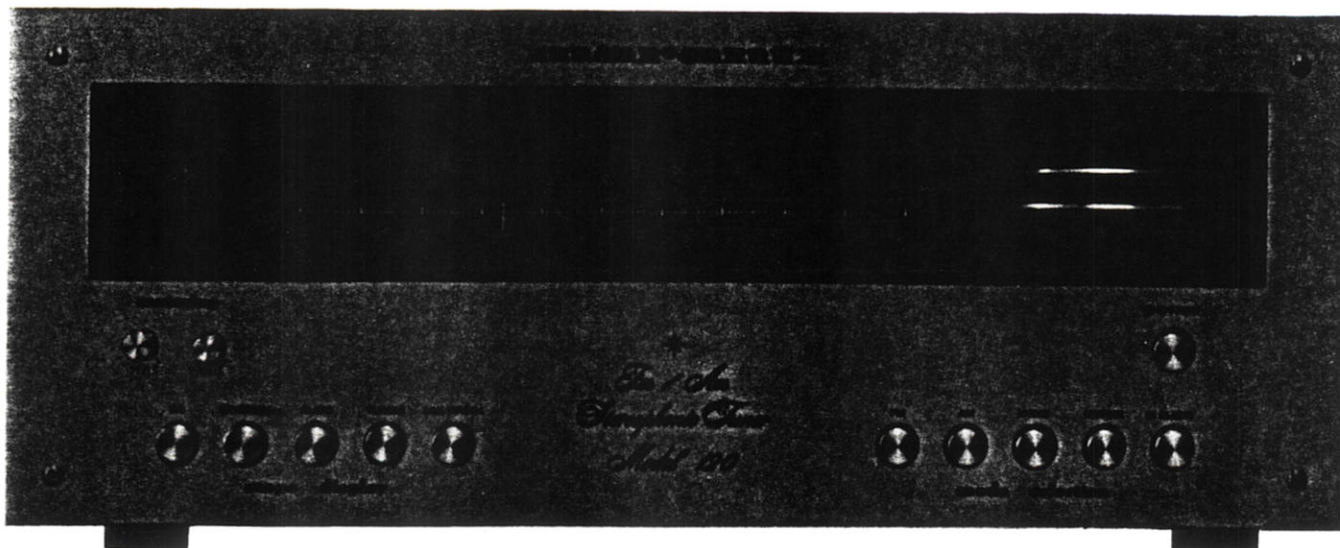

Figure 13. Front Panel

Your Model 120 features circuitry which mutes the audio outputs when tuned "off-station".

Depressing the **MUTING** pushswitch activates this circuitry.

The muting threshold can be varied by rotation of the **MUTING LEVEL** control on the rear panel. To prevent muting off very weak stations along with the noise, the muting function may be turned off by releasing the **MUTING** pushswitch to "out" position.

Hi BLEND SWITCH

With the pushswitch "in" stereo separation is reduced at high audio frequencies. For weak FM signals with excessive noise and/or interference. "Hiblending" provides suppression of out-of-phase noise. Unlike most FM noise filters, this does not sacrifice high end frequency response.

For normal listening, leave this pushswitch "out".

FUNCTIONAL DESCRIPTION

Figure 14 is a block diagram of the Model 120 Tuner showing the main functional elements and input and output signal routing.

FM FRONT END

FM antenna signals are applied through a balun transformer and the antenna attenuator switch to the antenna coil which drives a field-effect transistor RF amplifier. When the **ATTENUATOR** switch is placed in the "OUT" position, the attenuator circuit is cut off and FM signals are directly fed to the FM antenna coil. With **ATTENUATOR** switch placed in the "IN" position, the signals are attenuated about 20 dB by the attenuator circuit, then fed to the antenna coil. The amplified signals from the FM amplifier are fed through the triple-tuned RF filter circuit to the FET Mixer stage, which also receives the signal generated by the local oscillator. This mixer converts the carrier frequency to the 10.7 MHz intermediate frequency. Careful attention to its thermal and electrical characteristics has minimized drift, thus obviating the necessity for AFC. The 10.7 MHz converted signal is then fed to a phase linear ceramic IF filters, followed by an IC limiter. It is then, in turn, processed through an FM discriminator. The output of the FM discriminator is fed to a composite signal amplifier which then drives the demodulator.

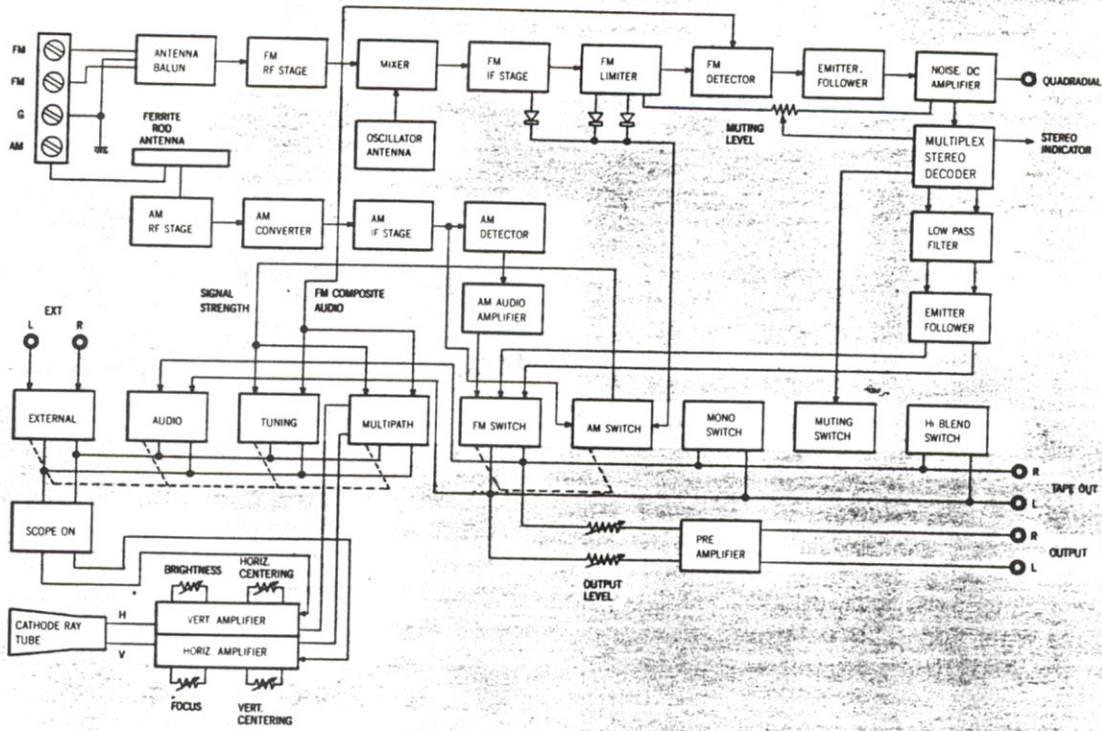

Figure 14. Functional Block Diagram

FM IF AMPLIFIER

The IF amplifier consists of 8 ceramic filters and 7 stages of IF amplifiers including limiter stages. The characteristics of these ceramic filters are ideal in that the 200 KHz passband and phase linearity assures the elimination of a major source of high frequency distortion and loss of stereo separation. The sharp cut-off slope improve selectivity, permitting reception of closely spaced channels. The Model 120 utilized symmetrical diode limiter circuits consisting of high performance Gold Bond Hot Carrier Type diodes and IF limiter amplifier with a very small dynamic aperture. Thus, undesirable amplitude modulation is removed from the IF signal within the limiter and good capture ratio is also assured. The amplified and symmetrically limited FM signals are fed to the super-linear discriminator circuit.

The detected audio signals are, then, distributed to the **QUADRADIAL** jack, MPX Decoder circuit and Noise amplifier.

FM STEREO DEMODULATOR

The composite audio signal from the buffer amplifier is fed into the multiplex stereo demodulator circuit consisting of 11 transistors and 6 diodes. The 19 KHz pilot signal contained in the composite audio signal is doubled into 38 KHz after

two-stage amplification and then the 38 KHz signal is further amplified to the level necessary to drive the diode switching circuit. The composite audio signal is decoded into the left and right channels by the 38 KHz switching signal in the diode matrix circuit. The right and left channel audio signals are processed in the crosstalk cancelling circuit which utilizes complementary configuration with NPN and PNP transistors. The audio signals are then fed into the low-pass filters for filtering undesired 19 and 38 KHz components and emitter followers for low impedance output.

The stereo demodulator circuit has been designed with the de-emphasis network to provide flat frequency response up to 15 KHz. One hundred percent air-tight coils and filters are incorporated in the stereo demodulator circuit for improved stability and reliability with good stereo separation and frequency response.

The multiplex stereo demodulator circuit has been provided with an automatic stereo/monaural switching circuit. The circuit checks the input signal intensity and activates the stereo demodulator circuit and the stereo indicator lamp automatically only when the input signal is powerful enough to provide good quality stereo reception. When the input signal strength is below the threshold level, the FM stereo broadcast is processed as monaural signal and improved signal-to-noise ratio is obtained in this mode of operation.

MUTING CIRCUIT

In the absence of an FM carrier, all FM receivers produce noise. The muting circuit eliminates this noise, providing you with noise-free tuning between stations. A muting circuit consisting of all solid-state electrical switching has been incorporated in the Model 120.

Three inputs control the muting function. The first is related to signal strength, the second to the noise condition at the detector, and the third is derived from the DC component of the detector output. These inputs are properly matrixed and gated to provide muting free from noise and transients.

SCOPE DISPLAY CIRCUIT

The scope display circuit of the Model 120 consists of two DC amplifiers, one vertical and the other horizontal amplifiers, and a very sensitive Cathode Ray Tube. Each signal to be displayed is selected by the appropriate **scope display** pushswitch on the front panel. When the **EXTERNAL** scope display switch is depressed, the input circuit of the DC amplifiers are directly connected to the **SCOPE INPUT** jacks on the rear panel. Thus, any external signals can be displayed on the scope.

In the case where the external audio signals are larger than 200 mV, they must be decreased to the value of 180mV by connecting an suitable resistor or voltage divider to the external source circuit to avoid over deflection of the scope trace.

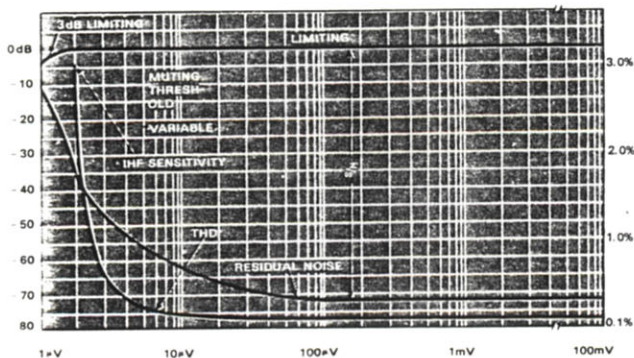

Figure 15. FM Characteristics

FOCUS, BRIGHTNESS, and CENTERING ADJUSTMENTS

The rear panel **FOCUS** and **BRIGHT** controls were properly preset at the factory. For your convenience, proper adjusting procedure is as follows:

1. Disconnect (or turn off) any accessory you have connected to the rear panel **SCOPE INPUT** jacks of your Model 120.
2. Depress **scope display** pushswitches **ON** and **EXTERNAL**. Center the dot with the front panel controls.
3. Adjust **FOCUS** for a sharply defined dot, and adjust **BRIGHT** so that dot is barely visible.

You may now use your Model 120 and/or accessories. Automatic beam intensifier circuitry will brighten the display when trace deflecting signals are applied to the horizontal or vertical amplifiers.

AM TUNER

The AM tuner portion of the Model 120 has been provided with a double tuned RF amplifier incorporating a three-section variable capacitor for improved selectivity and spurious response.

The ceramic filters utilized in the AM IF amplifier have very high selectivity and adequate bandwidth for interference-free AM reception. Following the AM IF amplifier, the AM detector recovers the audio modulation and provides this signal to the AM pushswitch.

The AM front end and IF amplifier are subjected to the action of an effective automatic volume control circuit which maintains constant the level of all stations in the AM band.

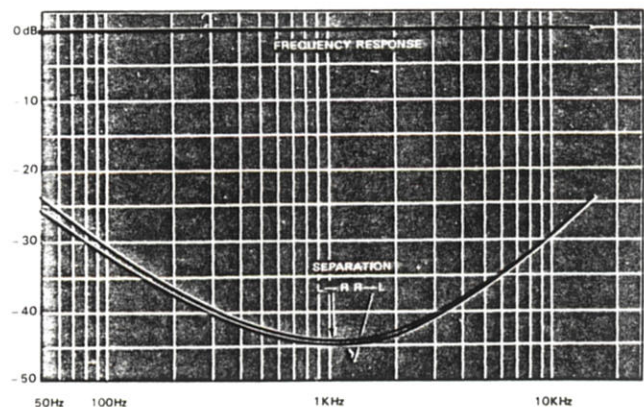

Figure 16. Stereo Separation

TECHNICAL SPECIFICATIONS

FM SECTION

Tuning Frequency Range	.88 MHz–108 MHz
IHF Usable Sensitivity	2.3 μ V
IHF Selectivity	80 dB
Capture Ratio	1.6 dB
Image Rejection Ratio at 106 MHz	93 dB
Signal to Noise Ratio in Mono	70 dB
Signal to Noise Ratio in Stereo	60 dB
Total Harmonic Distortion in Mono	0.15%
Total Harmonic Distortion in Stereo	0.3%
Frequency Response (ref. 75 μ .sec. de-emphasis)	\pm 1 dB (50 to 15 KHz)
Stereo Separation	42 dB at 1 KHz 26 dB at 10 KHz 36 dB at 200 Hz

AM SECTION

Tuning Frequency Range	540 KHz–1605 KHz
Usable Sensitivity	.20 μ V
Selectivity	26 dB
Image Rejection Ratio at 1400 KHz	70 dB
Signal to Noise Ratio	46 dB
Frequency Response, –3 dB down	50 Hz–4 KHz
Total Harmonic Distortion	1%

GENERAL

Power Requirements	100/120/200/220/240V AC 50 Hz to 60 Hz 40 Watts
--------------------	---

Dimensions

Panel Width	15.4 Inches
Panel Height	5.8 Inches
Depth	11.8 Inches

Weight

Unit Alone	21 lbs
Packed for Shipment	29.3 lbs

* These specifications and exterior designs may be changed for improvement without advance notice.

Please Pack the Tuner as Illustrated.

CAUTION

Please **DO NOT** ship the tuner mounted in its cabinet.

Insure tuner for full value:

Make sure that you correct return address is on shipping label.

Ship via a reputable carrier. **DO NOT USE PARCEL POST**-Be sure to obtain receipt from carrier.

SERVICE NOTES

REPAIRS

Only the most competent and qualified service technicians should be allowed to service the Marantz Model 120 Tuner. The Marantz Company and its warranty station personnel have the knowledge and special equipment needed for the repair and calibration of this precision instrument.

In the event of difficulty, write directly to the factory (to the attention of the **technical service department**) for the name and address of the nearest Marantz warranty or authorized service station. Please include the model and serial number of the unit together with a description of the problem.

If it should ever be necessary to ship the unit to the factory or authorized service station, **ALWAYS REMOVE THE TUNER FROM ITS CABINET**. Pack the unit carefully, using the original packing material. If the packing material has been discarded, lost, or damaged, write to the factory (to the attention of the **technical service department**) for new packing material. Carton, fillers, and packing instructions will be shipped to you at a nominal charge. No receiver should be returned to the factory without an Authorized Return Label which the Marantz company will supply if the description of difficulties appears to warrant factory service.

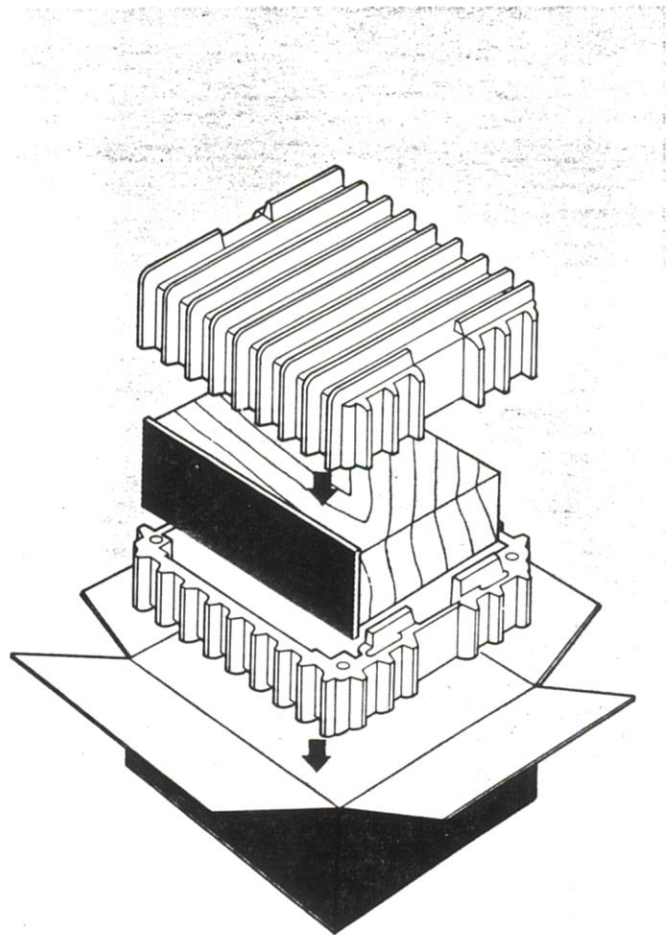

Figure 17. Packing Instructions