

# EMOTIVA



WHERE PASSION .....  
AND HOME THEATRE MERGE

## LPA-1

PROFESSIONAL 7 CHANNEL POWER AMPLIFIER

USER'S GUIDE

# Table of Contents

<b>Safety Precautions</b>	<b>4</b>
NEC (National Electrical Code) Standards	6
A Note for the Cable Television (CATV) Installer	6
Antenna Grounding Outside the House	6
<b>Thank You for your LPA-1 Purchase</b>	<b>7</b>
<b>Unpacking the LPA-1</b>	<b>8</b>
Inventory	8
Recording the Serial Number	8
<b>Emotiva LPA-1 Seven Channel Amplifier</b>	<b>9</b>
Professional 750 Watt Amplifier Features	9
<b>Front Panel Layout</b>	<b>9</b>
<b>Rear Panel Layout</b>	<b>10</b>
<b>Installation and Connections</b>	<b>11</b>
AC Power Considerations	11
Physical Placement	11
Input Connection Considerations	12
Output Connection Considerations	12
Bridging Channels 6 and 7	12
Connection Tips for Superior Sound	12
<b>Connection Diagrams</b>	<b>13</b>
Connecting a 7.1 Preamp/Processor	13
Connection using a 7 channel preout to LPA-1	13
Connecting a 5.1 Preamp/Processor	14
Connection using a 5.1 channel preout to LPA-1 (including LFE Channel)	14
Connecting a 5.1 and Second Zone System	15
Connection 5 main channels plus a second (2 channel) zone	15
Connecting Multiple Zones	16
Connection of up to 3 distinct (2 channel) zones	16
Connecting an Expanded Second Zone System	17
12V Trigger Connections	18
Speaker Output Connections	18
Series and Parallel Speaker Connections	19

Series	19
Parallel	19
Technical Note about Multiple Speaker Connections	20
<b>Troubleshooting Guide</b>	<b>21</b>
No Sound (from one or more speakers connected to the LPA-1)	21
The amplifier shuts down often or the line circuit breaker trips often	21
Poor Bass Performance From Full Range Speakers connected to the LPA-1	21
Turn-on and turn-off thumps	22
“Hum” Noises in the Speakers	22
Other Probable Causes of Noise	23
One or more RED lights on the Front Panel are Blinking	23
Problems with the whole A/V System	23
<b>LPA-1 Technical Specifications</b>	<b>24</b>
<b>Limited Warranty</b>	<b>25</b>
Service Assistance for the LPA-1	25
Emotiva Disclosure	25

# Safety Precautions

Read this User's Guide thoroughly before attempting to install and configure the Emotiva LPA-1 Amplifier. All the safety and operation instructions should be read before any operation of the component(s) begin. After successful installation and configuration of the Emotiva LPA-1 Amplifier, be sure to retain this manual in a safe place for any future reference needs.



All warnings on the Emotiva LPA-1 Amplifier and in these operating instructions should be followed. Safety is a key component to a long lasting and trouble free installation. The vast majority of the subsequent safety precautions involve simple common sense. If you are not comfortable with the installation of audio/video entertainment equipment, it will be to your benefit to seek the services of a qualified installation professional.

NEVER use the LPA-1 Amplifier near water such as a bathtub, washbowl, kitchen sink, laundry tub, in a wet basement, or near a swimming pool, etc. There is a risk of electric shock to your body and permanent damage to the equipment. Electric shock may result in permanent bodily injury or death.

The Emotiva LPA-1 Amplifier should be situated so that its location or installation position does not interfere with proper ventilation. The Emotiva LPA-1 Amplifier should not be situated on a bed, sofa, rug, or similar surface that may block any ventilation openings; or placed in a built-in installation such as a bookcase, cabinet, or closed equipment rack that may impede the flow of air through ventilation openings. If installed in a closed equipment rack for custom installations, be sure to add forced air ventilation so that it has adequate air circulation. The Emotiva LPA-1 Amplifier should be situated away from heat sources such as radiators, or any other devices which produce heat.

The Emotiva LPA-1 Amplifier should be connected to a power supply only of the type described in this User's Guide and what is labeled on the LPA-1 component. Power supply cords should be routed so that they are not in high foot traffic areas or pinched by items placed upon or against them, paying particular attention to cords at the wall plugs, convenience receptacles, and the point where they connect into the LPA-1 Amplifier. The power cord of the LPA-1 Amplifier should be unplugged from the outlet when unused for a long period of time. When it's time for cleaning the Emotiva LPA-1 Amplifier, it should be cleaned only as recommended in this User's Guide. Never spray liquids directly into the component's vent openings. Care should be taken so that small objects do not fall into the inside of the LPA-1 Amplifier.

The following situations require your Emotiva LPA-1 Amplifier is serviced only by qualified service personnel:



1. *The power-supply cord or the plug has been damaged; or*
2. *Objects have fallen, or liquid has spilled into the component; or*
3. *The LPA-1 has been exposed to rain; or*
4. *The LPA-1 does not appear to operate normally or exhibits a marked change in performance; or*
5. *The LPA-1 has been dropped, or its enclosure or chassis is damaged.*

The user should not attempt to service the LPA-1 Amplifier beyond the means described in this Owner's Guide. All other servicing should be referred to qualified service personnel.



**To prevent electric shock**, do not use this polarized plug with an extension cord, receptacle or other outlet unless the blades can be fully inserted to prevent blade exposure.

*Pour preevenir les chocs electriques ne pas utiliser cette fiche polarises avec un prolongateur, un prise de courant ou une autre sortie de courant, sauf si les lames peuvent titre inserees a fond sans laisser aucune parllle a decouvert.*

**Grounding or Polarization** — Precautions should be taken so that the grounding or polarization means of the component is not defeated.

This apparatus does not exceed the Class A/Class B (whichever is applicable) limits for radio noise emissions from digital apparatus as set out in the radio interference regulations of the Canadian Department of Communications.

*ATTENTION — Le present appareil numerique n'emmet pas de bruits radioelectriques depassant las limites applicables aux appareils numeriques de class A/de class B (selon le cas) prescrites dans le reglement sur le brouillage radioelectrique edicts par les ministere des communications du Canada.*

For questions regarding service, please contact:

**EMOTIVA**

Toll Free - (877) EMO-TECH  
Website - [www.emotivaaudio.com](http://www.emotivaaudio.com)

If you purchased your unit through AV123 and have service questions, please contact:

**AV123**  
2150 W. 6th Ave, Suite L  
Broomfield, CO 80020

Toll Free - (877) 543-7500  
Website - [www.av123.com](http://www.av123.com)  
e-mail - [info@av123.com](mailto:info@av123.com)

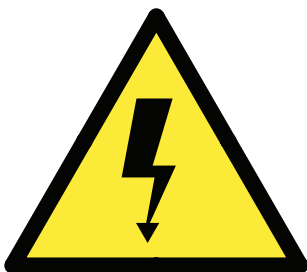

**WARNING** – TO REDUCE THE RISK OF FIRE OR ELECTRIC SHOCK, DO NOT EXPOSE THIS APPLIANCE TO RAIN OR MOISTURE.

**CAUTION:** TO PREVENT ELECTRIC SHOCK, MATCH WIDE BLADE OF PLUG TO WIDE SLOT, FULLY INSERT.

**ATTENTION:** POUR EVITER LES CHOCS ELECTRIQUES, INTRODUIRE LA LAME LA PLUS LARGE DE LA FICHE DANS LA BORNE CORRESPONDANTE DE LA PRISE ET POUSSER JUSQU'AU FOND.

## NEC (National Electrical Code) Standards

### A Note for the Cable Television (CATV) Installer

This reminder is to call the CATV system installer's attention to Article 820-40 of the NEC that provides guidelines for proper grounding and in particular, specifies that the cable ground shall be connected to the grounding system of the building as close to the point of cable entry as practical.

### Antenna Grounding Outside the House

If an outside antenna is connected to the receiver, be sure the antenna system is grounded so as to provide some protection against voltage surges and built-up static charges. Article 810 of the National Electrical Code, ANSI/NFPA 70, provides information with regard to proper grounding of the lead-in wire to an antenna-discharge unit, connection to grounding electrodes, and requirements for the grounding electrode. See diagram below.

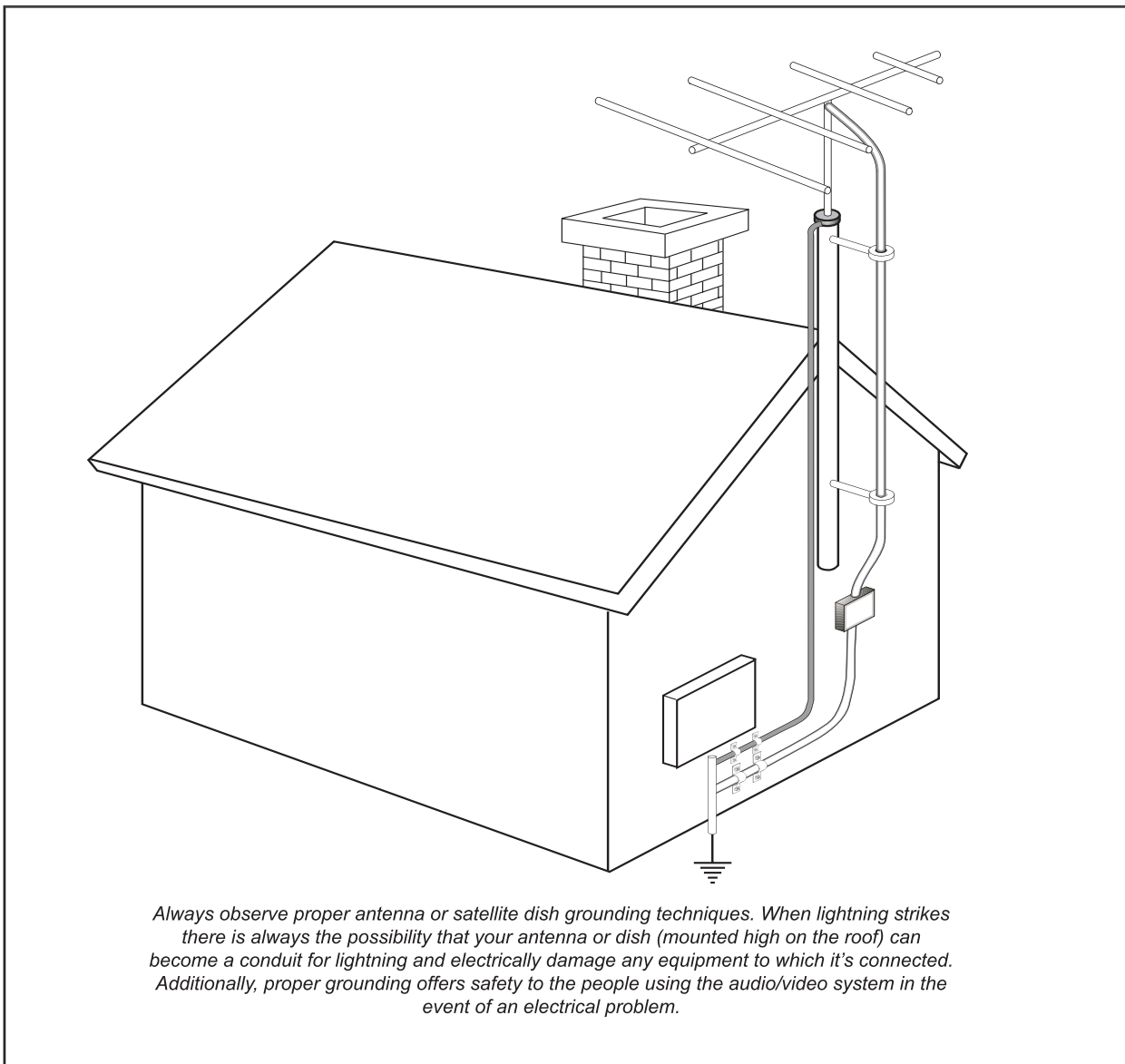

# Thank You for your LPA-1 Purchase

Dear Home Entertainment Enthusiast,

Thank you for purchasing the Emotiva LPA-1 Amplifier. We sincerely believe that it offers you outstanding performance and value. Emotiva products are engineered and produced with the highest quality materials and incorporate the latest technology. We think you will find the Emotiva LPA-1 meets or exceeds your expectations.

The Emotiva LPA-1 is a flexible, high performance amplifier. It has been designed for maximum performance, ease of use, and installation flexibility. By employing cutting edge technology, the Emotiva LPA-1 easily power to your speakers at high power levels, at the same time remaining as efficient as possible, regardless of volume levels. This allows you to fully enjoy audio and video sources without concern for dynamic headroom during complex musical passages and high level effects. What's more, the Emotiva LPA-1 does it all with exceptionally refined cosmetics and a sound quality that will satisfy even the most discriminating tastes.

The Emotiva LPA-1 features an array of leading edge technologies and all the features necessary to perform the functions expected of a high end Power Amplifier including a bridgeable 6th and 7th channel pair.

The Emotiva LPA-1 Power Amplifier is a rock solid component that allows you to control and manage all of your system's speakers with 7 amplifier channels in a single amplifier chassis. This makes installation of your home entertainment system much easier than connecting multiple mono or two channel amplifiers. At Emotiva, we remember that creating home audio/video products means that they should be easy to use while delivering unparalleled performance.



## Unpacking the LPA-1

The Emotiva LPA-1 Amplifier should reach you in flawless condition. If you notice any shipping damage or other issues upon unpacking the unit, please contact your Emotiva Retailer immediately.

### Inventory

Included with your LPA-1 amplifier should be an IEC Class 1, 2 prong power cord, and this User's Guide. Please take a moment to make sure all the items are there in the packaging.

Gently lift out the unit and remove all the packing material and accessories. This amplifier is heavy, so please unpack it carefully to avoid unnecessary injury or damage to the amplifier. It is important to save all the packing materials and the box in case your Emotiva LPA-1 ever needs to be moved or shipped back to the factory for service.

Make sure that you keep your sales receipt. It is the only way for Emotiva to establish the duration of your Limited Warranty and it may come in useful for insurance purposes.

### Recording the Serial Number

Please read the serial number located on the rear panel and record it below. Also record the place where you purchased this product and the date of purchase.

**Model Number** \_\_\_\_\_ LPA-1 \_\_\_\_\_

**Serial Number** \_\_\_\_\_

**Place of Purchase** \_\_\_\_\_

**Date of Purchase** \_\_\_\_\_

# Emotiva LPA-1 Seven Channel Amplifier

## Professional 750 Watt Amplifier Features

- Audiophile quality seven channel multi-channel power amplifier.
- Six 125 watt channels of amplification (one channel is configurable for two channel operation)
- Low noise 1.2 KVA torroid power transformer
- Complementary, discrete power amplifier design incorporating high current, high speed, Toshiba power devices
- Channel status indicators for standby, operate, and fault
- Configurable power output as follows: 125 watts/8 ohms x 6 channels or 125 watts/8 ohms x 5 channels plus 2 x 50 watts/8 ohms x 2 channels
- Completely stable into 4 ohm loads
- Signal to Noise Ratio is greater than 100dB, unweighted ref. full output
- THD .03% at rated power, 20Hz – 20kHz
- Fully protected from all fault conditions
- Soft start circuitry
- External trigger turn on
- Soft touch power switch
- 4RU chassis w/ solid milled aluminum faceplate
- IEC power inlet, 120/230 VAC configurable

## Front Panel Layout

### Front Panel LED Display

The front panel display contains informative LED lighting to indicate the condition of the LPA-1.

- NO LED =** Amplifier is OFF
- BLUE LED =** Normal Operation
- FLASHING RED LED =** Fault Condition

See "Troubleshooting" section for details.

### Front Panel Power Switch

This switch provides the ON/OFF control of the LPA-1 from the front panel. When the unit is off and in standby mode, the switch illuminates yellow. Automatic switching is accomplished with the 3.5mm trigger input on the back panel using a 3-12VDC control signal.

### Rubber Feet

These rubber feet keep the LPA-1 elevated for bottom ventilation as well as for vibration isolation.

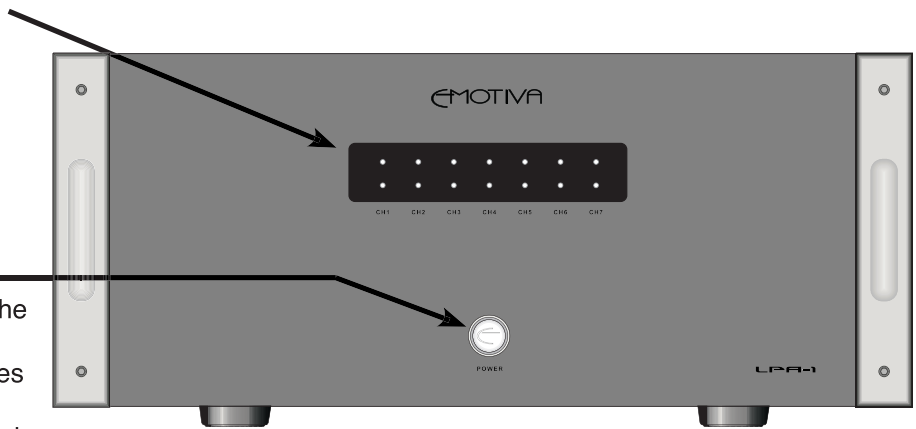

# Rear Panel Layout

## RCA Audio Inputs

These inputs provide the signal information for each channel on the LPA-1. Simply connect them to the appropriate output of the preamplifier/processor or other preamp level audio device. Channels 6 and 7 (far left) can be used as a bridged output, in which case it only requires an input from channel #6

## Master Power Switch

This rocker switch provides the master power for the LPA-1. After it is in the ON position, the amplifier can be turned on manually from the front panel switch or automatically with the trigger input via 3.5mm input jack.

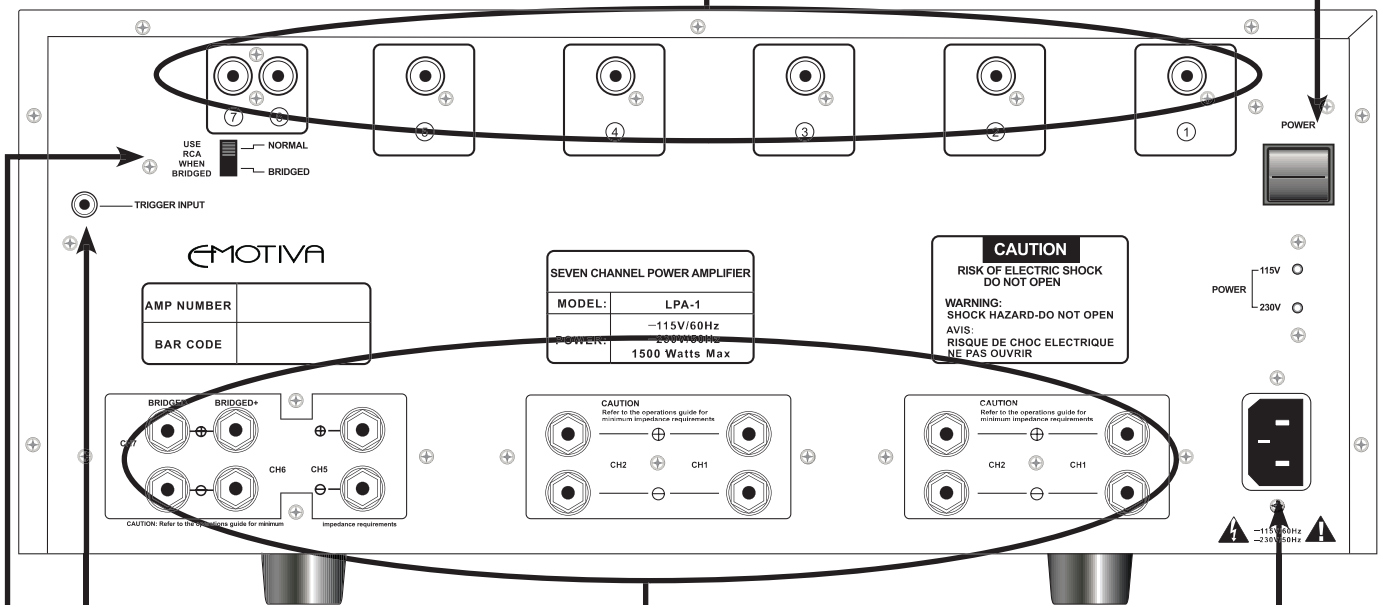

## Remote Turn On Jack

This 3.5mm jack accepts a 3-12 volt input for remote activation of the LPA-1. This mates directly with the Emotiva LMC-1 trigger output and supplied cable. If building your own cable, center is positive and outer shield is negative.

## Speaker Outputs (5 way Binding Posts)

These are the speaker outputs. The 5 way binding posts accept stripped speaker wire, banana plugs (single or dual), or spade connectors. Be sure to observe correct polarity when connecting speakers and be sure that the wires do not touch between positive and negative terminals.

## Channels 6 and 7 Bridged

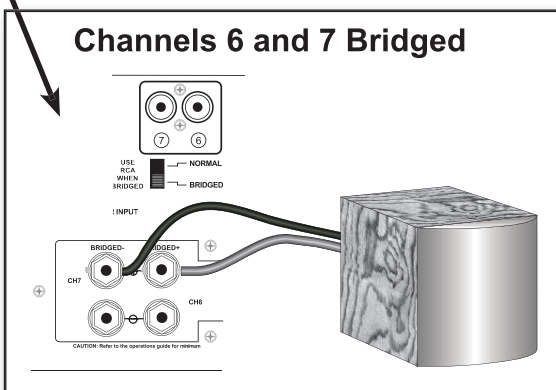

When bridging channels 6 and 7 to a passive (non powered) subwoofer system, refer to the diagram at left.

## Power Receptacle

Standard IEC 3 prong power receptacle. It is advised that this amplifier have a direct connection to a wall outlet. Do not plug into a "power strip".

# Installation and Connections

## AC Power Considerations

Ensure that the unit is plugged into an outlet capable of supplying the correct voltage and current specified for your model. Remember to account for the electrical power that other components will require if they share a common wall socket or electrical circuit. The majority of household electrical sockets in places other than the kitchen and garage are 15 amperes maximum. Most DVD players and other source components are fairly low current items. When all seven of the power modules are driven, the Emotiva LPA-1 requires a minimum of 10 amperes @ 120 volts or 5 amperes @ 230 volts. It should be sufficient to allow the other devices such as preamplifiers and A/V source units to share a wall socket, but power amplifiers such as the LPA-1 and a video display (big screen TV or video projector) should be provided a SEPARATE electrical connection on a SEPARATE circuit. As the LPA-1 has a minimum requirement that can consume nearly one entire circuit, please use a second (separate) electrical connection for other devices. DO NOT plug the LPA-1 into a power strip or extension cord unless the device is specifically designed and rated for high current use.

Refer to your preamplifier, A/V source component(s), and video display owner's manuals to learn the power requirements so you can safely plan your electrical power requirements for your home entertainment system.

Upon powering up the LPA-1 with the front panel switch or via 3.5mm trigger input (switch on the rear panel must be set to "ON"), you will notice the front panel LED lighting starts off red and cycles through each channel until complete, then all channels illuminate blue. This indicates the amplifier is on, functioning normally, and ready for operation. If you experience no LED light or a blinking red LED light while the amplifier is on during (otherwise) normal operation, please refer to the troubleshooting section of this manual.

## Physical Placement

Place the LPA-1 on a flat, level surface. Please distribute the weight equally on the four feet. Please give this unit adequate ventilation for proper cooling when placing. If this unit is placed in a cabinet, please make sure that the cabinet's rear is open to fresh air and there are at least 6 inches of free air space above the amplifier and 1 inch on each side. If the amplifier is located on a carpeted surface, place a board under the amplifier's feet. If the cabinet's design will not accommodate an open rear, install two small brushless DC fans (such as those used in computer cases) to provide continuous air flow into and out of the cabinet.

Do NOT block the ventilation holes on the LPA-1. The LPA-1 is equipped with a massive toroidal power transformer. This transformer generates a magnetic field that could induce a hum in a turntable (particularly a turntable equipped with a moving coil cartridge). Do NOT place a turntable directly above or directly adjacent to the LPA-1.

Before placing the LPA-1 on a shelf, verify that the weight bearing capacity of the shelf is 75 lbs or greater. The amplifier is heavy and should be placed toward the bottom of an audio rack to minimize the rack being unnecessarily top heavy.

## Input Connection Considerations

Whenever possible, keep preamp level audio cables away from electrical power cords by at least a few inches. It's more important with amplifiers as the AC power cords are carrying much more current than other source and preamplifier components, which means there is a larger degree of noise or "hum" potential with the amplifier power cord in close proximity.

## Output Connection Considerations

The output connectors provided on each channel of the LPA-1 are standard "binding post" speaker connectors with industry standard spacing. These are sometimes called 5-way binding posts because of the many ways in which the speaker wire can connect into the posts. The posts can accept bare wire, spade terminals, and dual or single banana connectors. Spade connections or banana plugs ensure a simple, solid fit in the terminal whereas bare wire may be awkward when the terminal is screwed down to compress the wire into place. Keep in mind that if you use "dual banana" plugs and "stack" them, you will be creating a parallel connection. For more details on series and parallel connections, see pages 19-20.

It is important to observe polarity so that the speaker wire connects to the red and black terminals on the amplifier and the corresponding terminals at the speaker. Also make sure that the positive speaker wires do not touch the negative speaker wires, or any chassis metal. This will cause a short circuit and activate the protection circuitry.

### Bridging Channels 6 and 7

When you are using channels 6 and 7 in a bridged configuration, in which case the right side positive terminal is the POSITIVE BRIDGED output and the left side positive terminal is the NEGATIVE BRIDGED output. The switch on the back of LPA-1 must be placed in the "BRIDGED" position. Minimum impedance on this bridged channel is 8 ohms.

## Connection Tips for Superior Sound

Before setting up your new system, please consider the following:

- *Always make sure the LPA-1 is turned off before making or changing ANY connections.*
- *Whenever possible, route the power cords away from the signal cables or speaker wires to prevent any hum or interference heard in the speakers.*
- *Many RCA type patch cords can be a very tight fit and there is usually a preferred method of getting them off. Some have to be removed with a twisting action. Be gentle or you may damage the jacks of your LPA-1, the cables themselves, or other components.*
- *Many audiophile signal cables are intended to be hooked up in one direction. If this is the case the cables will be marked with arrows the direction of signal flow.*
- *It is usual for the right channel RCA patch cord plugs to be red and the left channel connections to be white, grey, or black (depending on the cable brand). RCA connectors that are gold will be designated with a colored band to designate the channel.*

# Connection Diagrams

## Connecting a 7.1 Preamp/Processor

Connection using a 7 channel preout to LPA-1

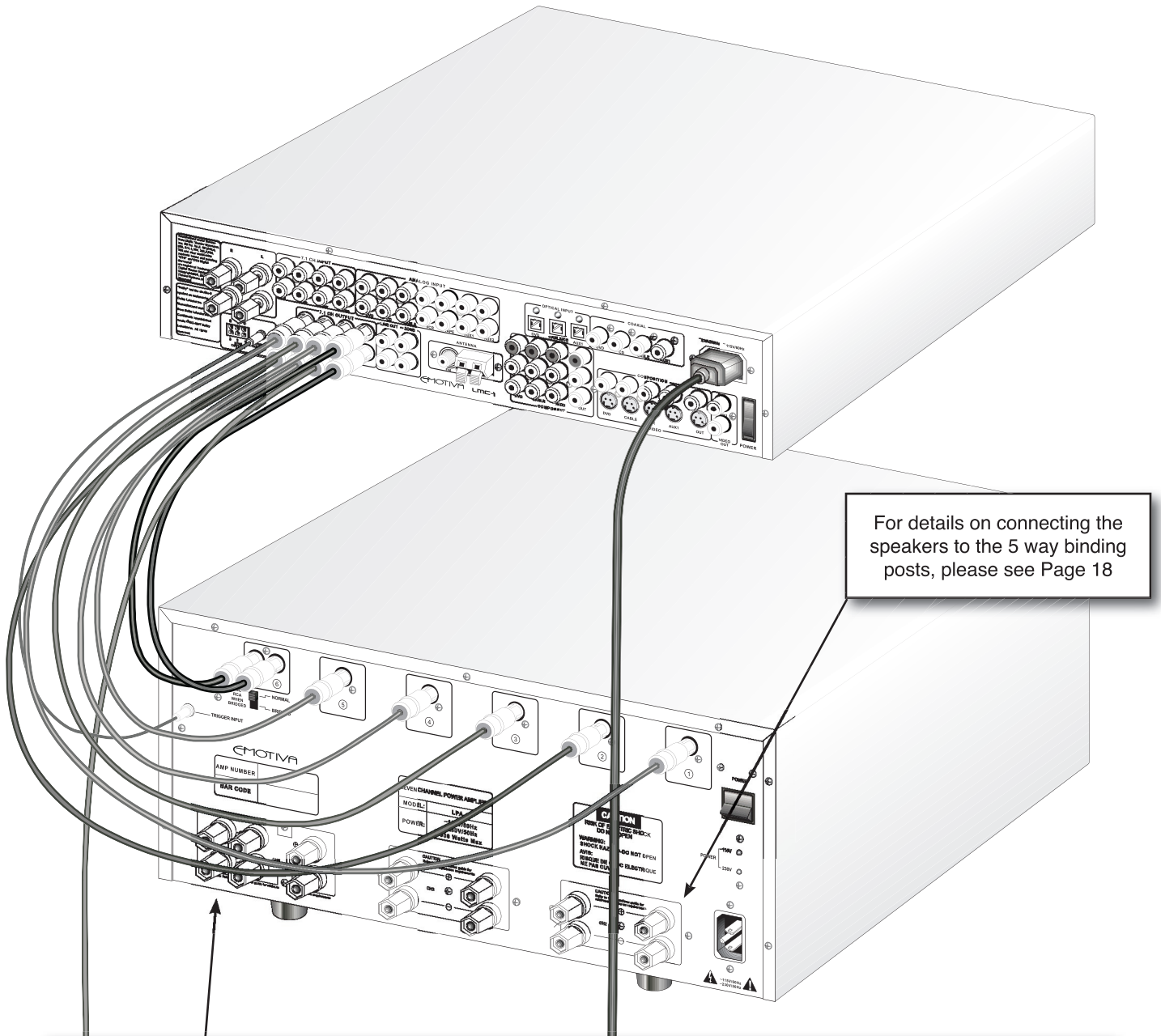

For details on connecting the speakers to the 5 way binding posts, please see Page 18

When connecting the LPA-1 to drive a 7.1 system, you can use channels 1-5 for the “Main” speakers as you wish, but Emotiva recommends using channels 6 and 7 as the “Rear Back” surround channels so that the power is distributed correctly in the room. This will yield the best results from the front L/C/R speakers and the main surround channels.

## Connecting a 5.1 Preamp/Processor

Connection using a 5.1 channel preout to LPA-1 (including LFE Channel)

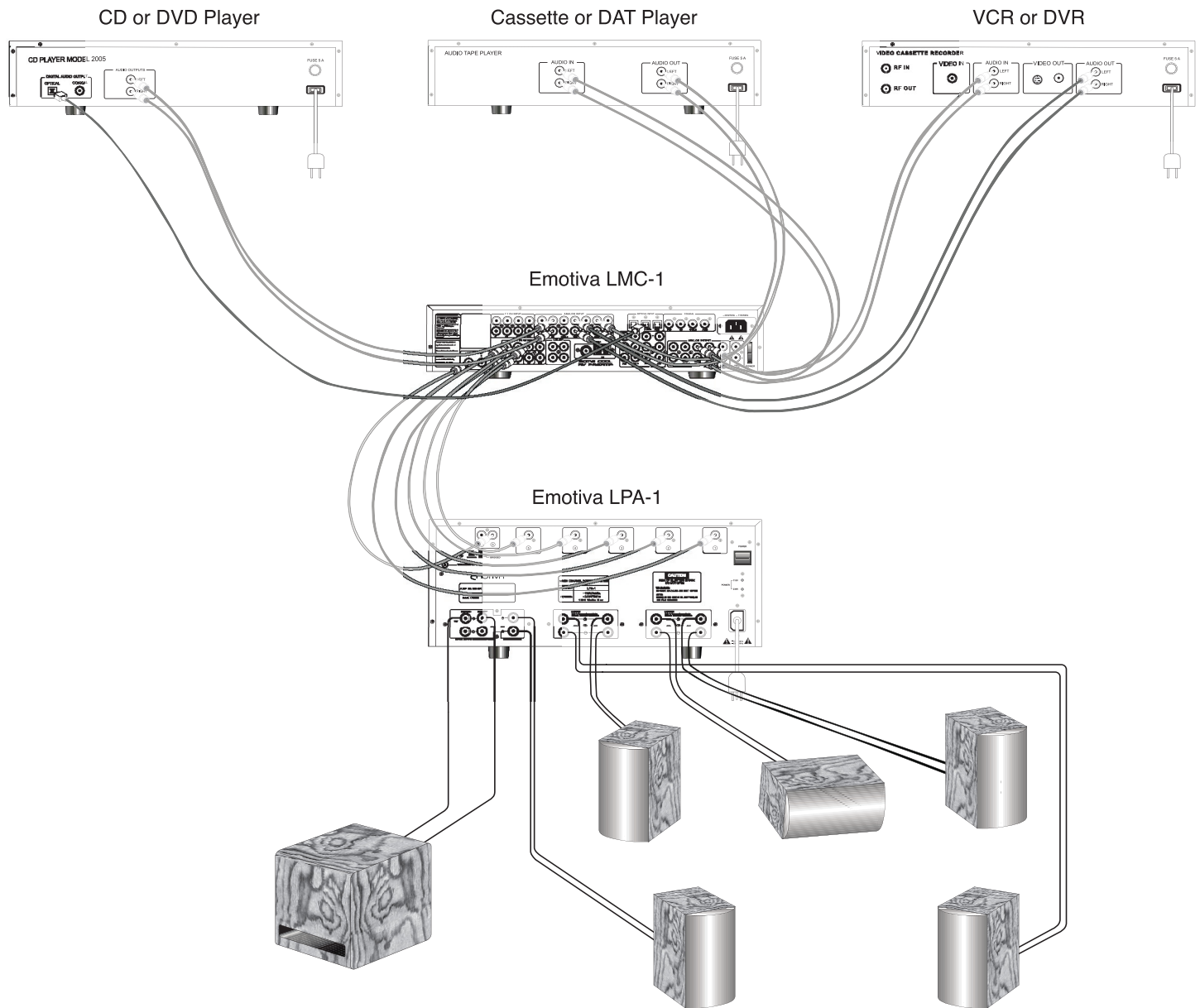

This configuration shows the LPA-1 driving five full range channels and using channels 6 and 7 in a bridged configuration for a non powered subwoofer. This type of configuration is ideal for enthusiasts who have (or will) make their own subwoofer and want to utilize an amplifier that will drive the entire system in one chassis.

# Connecting a 5.1 and Second Zone System

## Connection 5 main channels plus a second (2 channel) zone

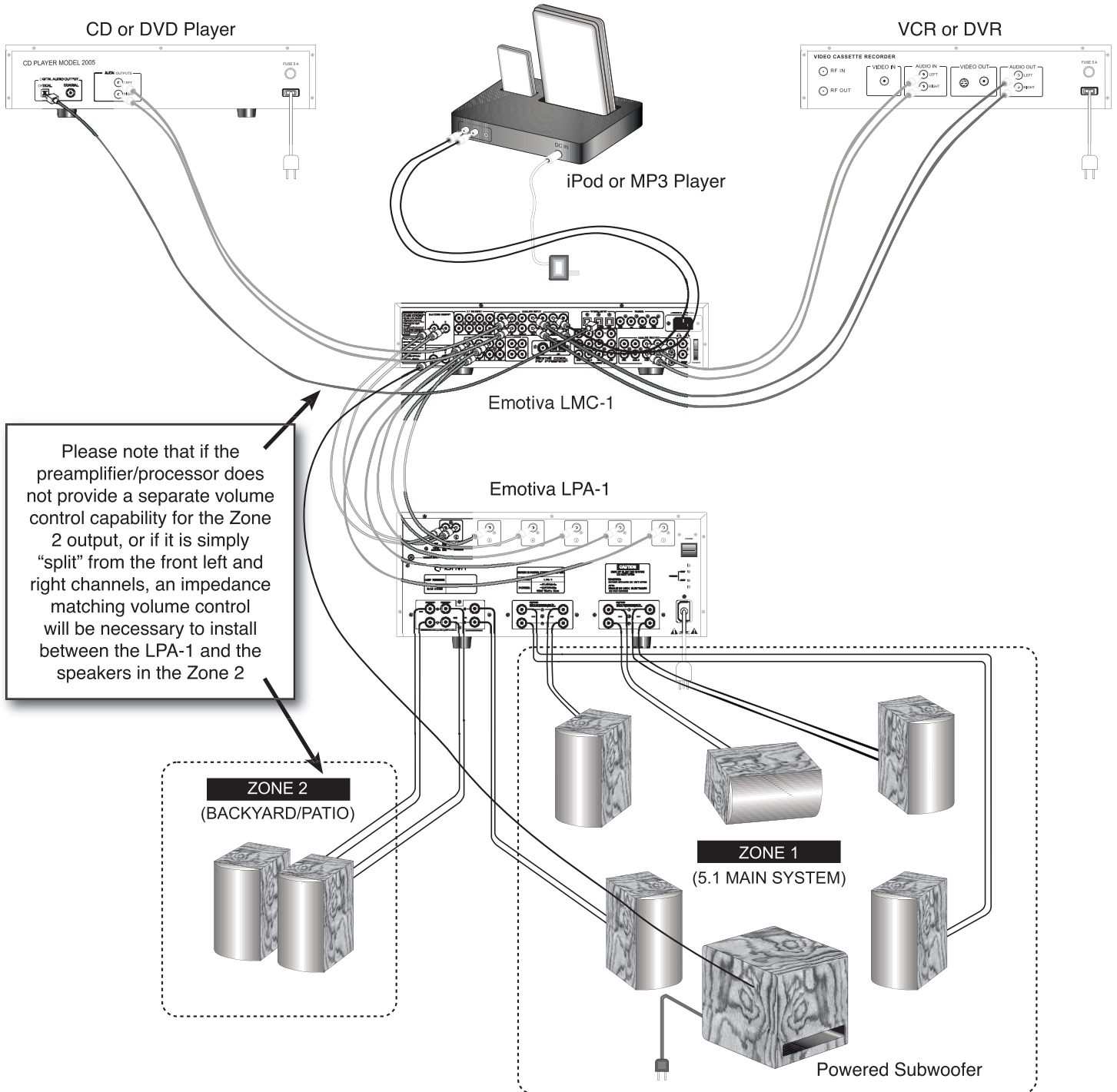

This configuration shows the LPA-1 driving five full range channels and using channels 6 and 7 for a second zone that is fed from the Zone 2 preamp output of the main preamplifier/processor. This type of configuration is ideal for enthusiasts have a 5.1 channel theater system that already has a powered subwoofer and wish to use the remaining two channels to drive speakers elsewhere in the home.

# Connecting Multiple Zones

Connection of up to 3 distinct (2 channel) zones

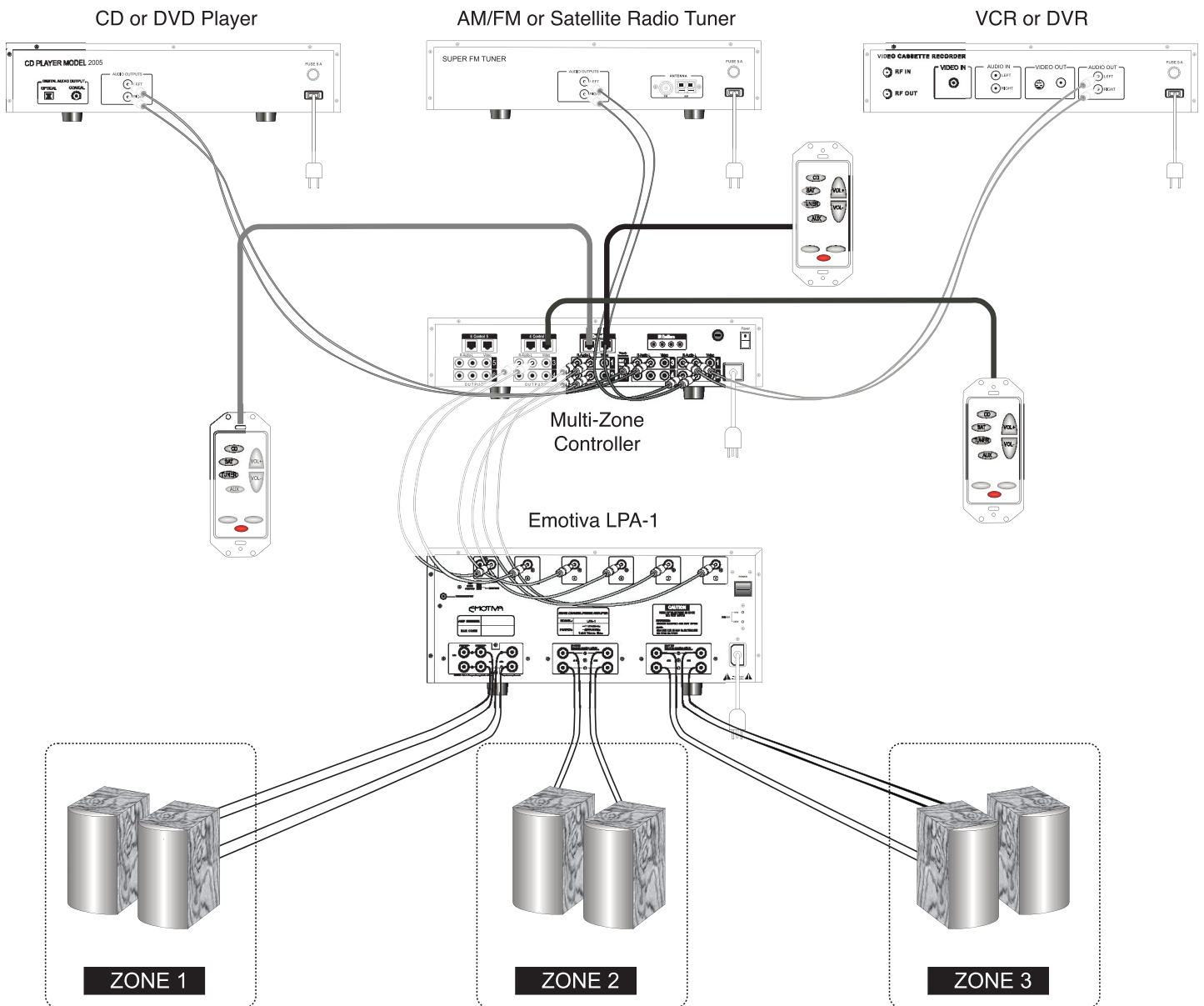

This configuration shows the LPA-1 three independent zones of audio through a “multi-zone controller”. The source units connect into the multi zone controller, as do the application specific keypads. From there, the preamp outputs for each zone connect to the LPA-1 and then each zone connects to two channels of LPA-1 power. In this configuration, channels 6 and 7 would be bridged to complete the channel 5/6 pair.

# Connecting an Expanded Second Zone System

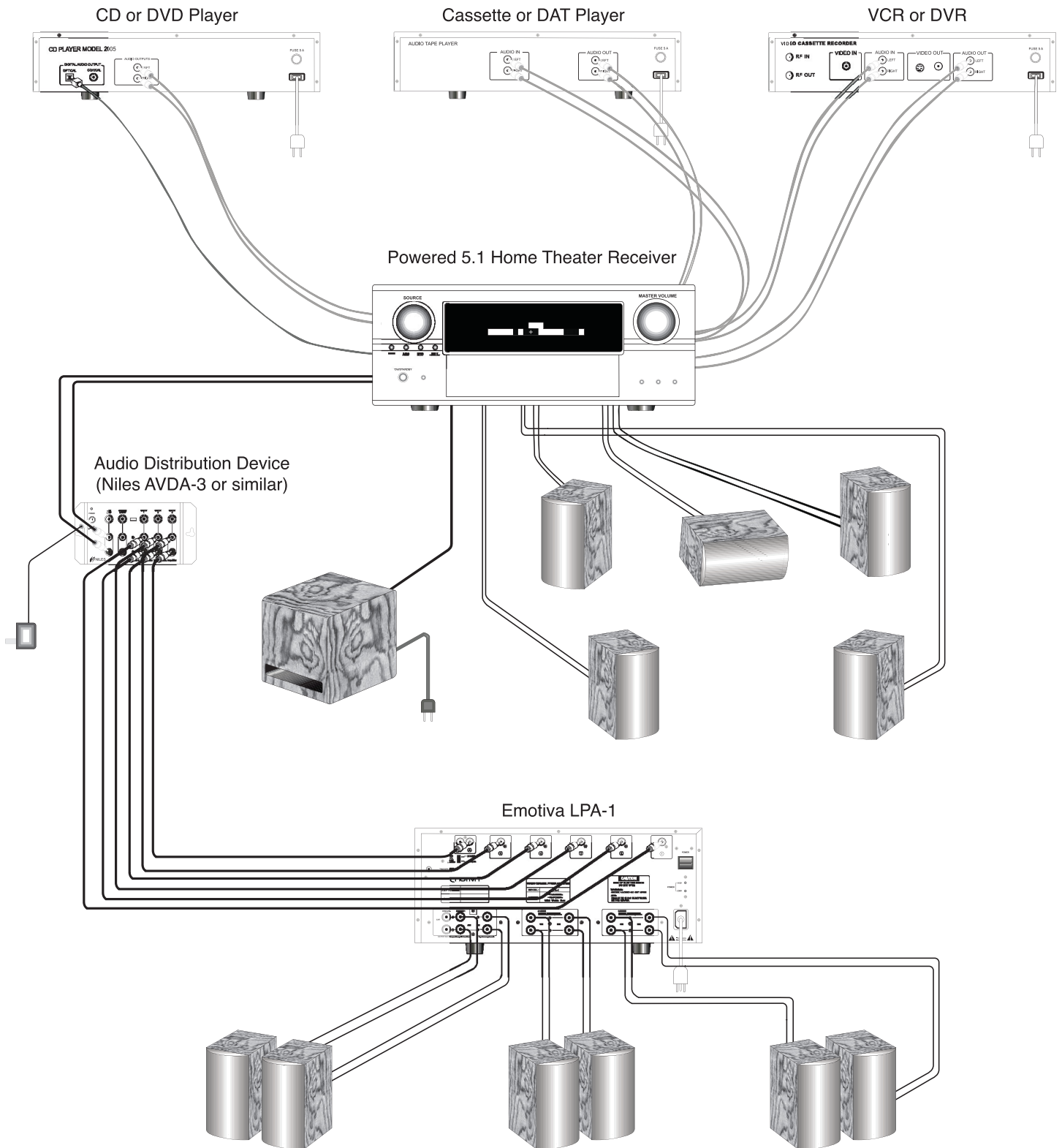

Please note that if the receiver does not provide a separate volume control capability for the Zone 2 output, or if it is simply "split" from the front left and right channels, an impedance matching volume control will be necessary to install between the LPA-1 and the speakers in each Zone.

### 12V Trigger Connections

The 12 VDC trigger connection shown can be used to turn the amplifier on when the preamplifier turns on. This trigger will actually trigger with any switched DC Voltage from 5-12 VDC, however the majority of home theater components use a standard 12 VDC trigger connection for this function. This is the preferred connection as it has the greatest degree of reliability.

**Never switch anything that plugs directly into the wall with this trigger connection. This action will damage the unit and VOID THE WARRANTY.**

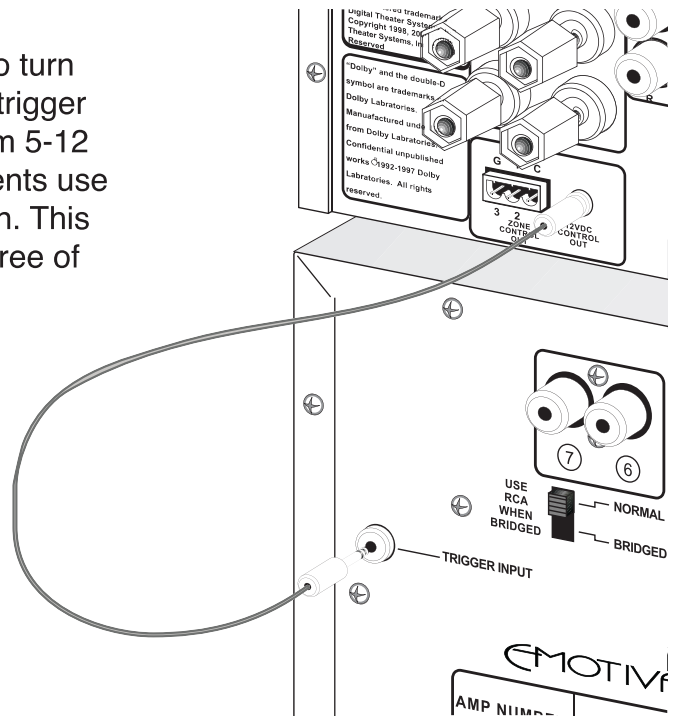

### Speaker Output Connections

The speaker output terminals for each amplifier channel are located across the bottom of the LPA-1. The top post of each binding post pair is the positive output, and connects to the positive (red) post of your speaker. The bottom post of each pair is the negative, and connects to the negative (black) post of your speaker. The only exception is when you are using channels 6 and 7 in a bridged configuration, in which case the right side positive terminal is the POSITIVE BRIDGED output and the left side positive terminal is the NEGATIVE BRIDGED output.

Regardless of the configuration used for the LPA-1 amplifier channels, proper connection of each speaker is essential. The 5-way binding posts can accept bare wire, spade terminals, and dual or single banana connectors. Spade connections or banana plugs ensure a simple, solid fit in the terminal whereas bare wire may be awkward when the terminal is screwed down to compress the wire into place. Keep in mind that if you use “dual banana” plugs and “stack” them, you will be creating a parallel connection and this amplifier is not rated to play below 4 Ohms per channel.

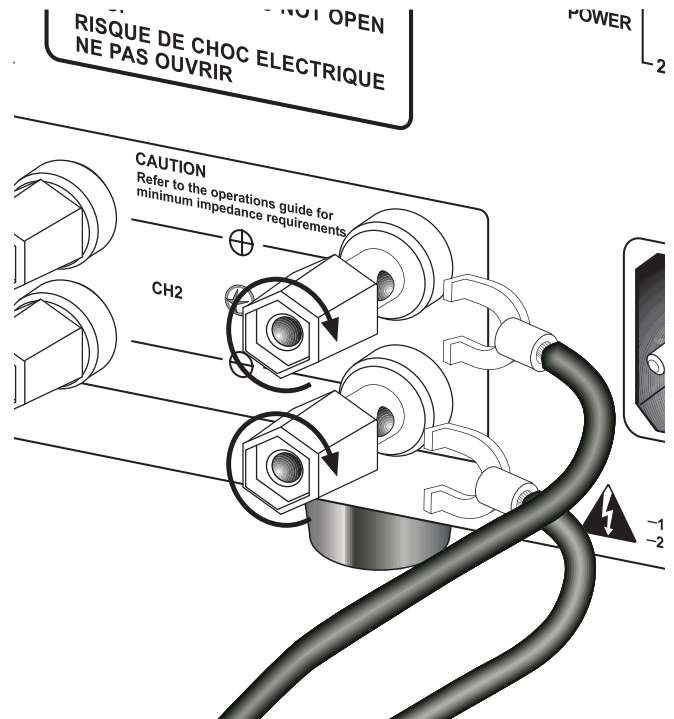

## Series and Parallel Speaker Connections

Whenever connecting more than one speaker per channel to an amplifier (regardless of the brand), you must consider the way in which the amplifier will be impacted by adding the additional speaker(s). Additionally, speakers with dual voice coils also apply to this consideration. Two voice coils in a single speaker also cause different reactions from an amplifier depending on the way in which they connect to the amplifier.

The connection of more than one speaker per channel will tend to degrade the speaker's frequency response and may make the amplifier run hot. For the best sonic results, use one speaker per amplifier channel. If you must connect more than one speaker per channel, there are two methods in which to do so: Series or Parallel.

### Series

A **series** connection is established when voice coils are connected in a string – end to end – so there's only *one* way for audio signals to flow "in" and only one way for audio signals to flow "out". For example, if you were to series-connect two speakers to the front right channel of the amplifier:

- *The positive output terminal of the right channel connects to the positive input post of the first speaker.*
- *The negative input post of the first speaker connects to the positive input post of the second speaker.*
- *The negative input post of the second speaker connects to the negative output terminal of the right channel.*

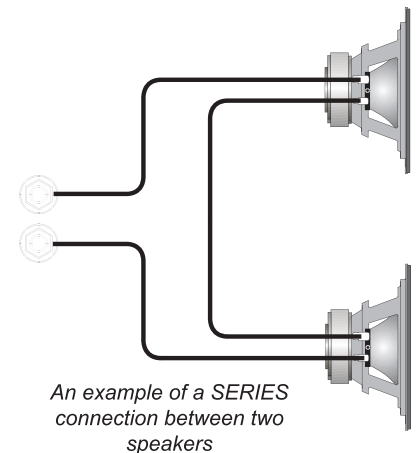

The total impedance of speakers in series is found by adding their impedances together. For example, two four ohm speakers in series is an eight ohm load. Series connections are easier on the amplifier than parallel connections as the total impedance is higher than driving a single speaker.

### Parallel

A **parallel** circuit is established when voice coils are connected in a way that there are multiple paths for audio signals to flow "in" and multiple paths for audio signals to flow "out". When speakers are connected in parallel, the total resistance at the amplifier is proportionally divided based on the value of each individual voice coil resistance. The term "divided" simply means all of the values together in parallel are a **SMALLER** value than each all by itself. For example, if you were to parallel connect two speakers to the front right channel of the amplifier:

- *The positive output terminal of the right channel connects to the positive input post of the first speaker **and** to the positive post of the second speaker.*

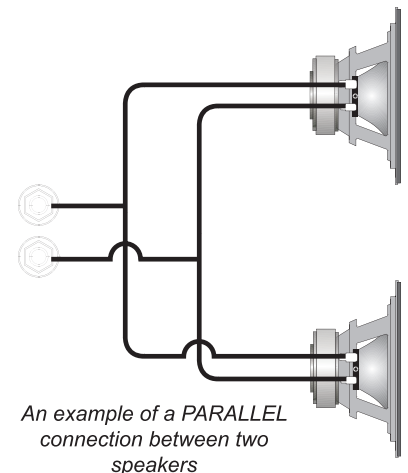

- *The negative output terminal of the right channel connects to the negative input post of the first speaker **and** to the negative post of the second speaker.*

The total impedance of equal speakers in parallel is found by dividing the impedance of one speaker by the number of speakers. For example, two eight ohm speakers in parallel is a four ohm load (eight ohms divided by two), four eight ohm speakers in parallel is a two ohm load (eight ohms divided by four). Two ohm single channel loads are **NOT RECOMMENDED** for the LPA-1! Furthermore, if you are bridging channels 6 and 7, the minimum load is 8 ohms. Running the LPA-1 below recommended impedance level can cause excessive heat and will eventually drive the amplifier into protection (blinking red LED's on the front of the unit).

Parallel connections are harder on the amplifier than series connections, as the total impedance is lower compared to driving a single speaker, and the amplifier must produce more current to drive them.

Ideally, the total average impedance should be no less than 4 ohms per channel. You must make sure that the lower impedance does not cause the amplifier to overheat, shut down, blow the line fuse, or trip your circuit breaker. If this happens, you should reduce the number of speakers wired in parallel, rewire them in series, or use more than one power amplifier.

### **Technical Note about Multiple Speaker Connections**

Although there are two possible connection types discussed in this manual, it is imperative that with either connection type that you use loudspeakers of the same type and nominal impedance for these connections. In doing so, you have the most predictable outcome for your installation. When speakers of different nominal impedances and/or different bandwidths are used, there are many other acoustic problems that come into play in addition to complex impedance at the amplifier's speaker output terminals. If you must use multiple speakers on any individual amplifier channel, please use speakers as close to identical as possible.

## Troubleshooting Guide

The Emotiva LPA-1 is expertly designed and built to provide years of trouble-free performance. Most problems that occur can usually be solved by checking your setup or making sure that the audio and video components connected to the amplifier are on and fully operational.

The following information will help you deal with common setup problems you may experience during normal use of your unit. If problems persist, contact your Emotiva Dealer for help.

### No Sound (from one or more speakers connected to the LPA-1)

- *Speaker cables may have come undone. Turn off your system and check the cables, and tighten the amplifier and speaker binding posts.*
- *Damaged audio cable.*
- *The preamplifier volume level is low for the channels concerned. Recheck the preamplifier calibration procedure.*
- *A preamplifier Mute switch may be on, or an external processor loop or a tape monitor loop is engaged.*
- *Check that your preamplifier or source is running the correct surround sound mode. Maybe it is set for 2-channel stereo when you were expecting 5.1 surround sound.*
- *Check in case any missing channels have been turned off in a preamplifier setup menu. For example, the center amplifier channel will not receive a signal if the preamplifier has been set to "Phantom."*
- *If the unit is not on, the ON/OFF switch on the LPA-1 might be in the off position.*
- *A internal fuse on the unit may have blown. Contact your Emotiva Dealer or AV123 for assistance.*

### The amplifier shuts down often or the line circuit breaker trips often

- *Check that the positive and negative speaker wires are not shorted together.*
- *Make sure that no speakers are shorted internally. If you have an ohm-meter, disconnect the speaker wires and measure the resistance between the speaker's positive and negative terminals. If the reading is less than 2.66 ohms on a single channel or 8 ohms on channels 6 & 7 when bridged, the speakers may have an internal short or you have connected several using a parallel configuration that yields too low an impedance. Measure all speakers and check their impedance specifications. If necessary, review the "Series and Parallel Connections" section of this manual.*
- *If you have connected speakers in parallel, the overall impedance may be too low. It is recommended that you rearrange the speakers in series to increase the overall impedance, thus taking some of the load off the amplifier.*
- *Make sure that the amplifier has good ventilation and is not overheating. Allow good airflow underneath wherever possible. If the amplifier is in a closed rack, open up the rear panel or use a quiet fan for improved ventilation.*

### Poor Bass Performance From Full Range Speakers connected to the LPA-1

- *Make sure that your preamp does not have the bass (tone control) level turned down.*
- *Many surround preamplifiers have controls which can direct all the bass to subwoofers, or let your main speakers play the full range. Make sure that the preamplifier has been correctly set. If you are not using a subwoofer, set the speaker options to "Large" where possible.*

- Check that the speaker wires have been connected correctly: Make sure that the positive of each speaker connects to a positive output of the amplifier, and the negative of each speaker connects to a negative output. If one speaker is wired incorrectly, than it will be “out of phase” with the others, resulting in poor bass performance. **DOUBLE CHECK ALL THE SPEAKER CONNECTIONS!!**

### Turn-on and turn-off thumps

- Plug the amplifier into an un-switched AC outlet, and use the 3.5mm Trigger Input connection with a trigger between 3-12VDC from the source unit or preamplifier (such as the Emotiva LMC-1 Preamplifier/Processor). This should allow the amplifier to turn on and off silently.
- If your powered subwoofer is the cause of the “thump” sound (not the other speakers connected to LPA-1), plug it into a different 110VAC outlet than the LPA-1 amplifier so there is no power surge conflict.
- Install a line conditioning device. Contact your Emotiva Dealer or AV123 for details.

### “Hum” Noises in the Speakers

This problem is more than likely caused by a “ground loop” in your system, rather than a fault in the LPA-1. Follow these steps to isolate the main cause of the hum, there may even be more than one. Remember to turn off all components in your system, including the LPA-1, before disconnecting or connecting any cables.

- Remember to turn off all components in your system, including the amplifier, before disconnecting or connecting any cables during troubleshooting.
- Try to have all of your equipment on the same electrical outlet or circuit. Group all the low power components (preamp, CD player, DVD etc.) on a single outlet or power strip. This is provided that the overall current draw from your equipment does not exceed the rating of the outlet or breaker.
- Disconnect all cables which come from outside the room, and check if the hum goes away. This includes such connections as cable TV, satellite TV, or roof top antennas. Make sure that they are disconnected where they first enter the room, so they are making no connection to the preamplifier or the TV, or any other component. If the hum is caused by the cable TV line, then you will need a “ground loop isolator.” This is an inexpensive device fitted in line with the coaxial cable feed. Contact your cable company or your Emotiva Dealer (unless purchased through AV123) for assistance.
- Disconnect all connections from the preamplifier to your TV, VCR or DVD.
- As a test, disconnect any other component which has a grounded power cord.  
**NOTE: Never remove the ground pin from any power cords (if present). This is very dangerous.**
- If the hum persists, disconnect all the source components one at a time from the back of the preamplifier, until you identify the problem.
- Try moving the speaker cables away from any power cords. Try just one speaker, connecting it to each amplifier channel and see if one channel is bad.
- Check that the interconnect cables to the amplifier do not have any broken connections. The best way to do this is to substitute a known good connection for the suspect connection. If you reverse the cables and the problem goes away, the cable may be damaged or broken. This is possible even if you can't physically see the break as the strain for pulling on audio cables can sometimes break the wire internally.

Ground loop isolators are available for audio lines and video devices. If you need assistance, contact your Emotiva Dealer. Although this is not always an ideal solution, the grounding differences between certain home entertainment components sometimes require ground loop isolators. This is the exception rather than the rule.

### Other Probable Causes of Noise

Speaker noise may also be caused by interference or noise on your AC line. Make sure there are no large appliances sharing the line, or halogen lamps or light-dimming Triac devices.

- *Try connecting your system to another AC socket on a separate line.*
- *If the hum is heard from within the LPA-1 and not through the speakers, this may also be caused by interference on the AC or DC lines. The power transformers may turn this interference into an audible noise. Internal hum can be made worse by a shelf or cabinet resonating, so try moving the LPA-1 to another shelf.*
- *Try moving your components further away from the TV, especially if you ever notice the screen has changed color in the area closest to the component.*
- *If you have very high efficiency speakers, these may tend to reveal noises which other speakers do not.*

### One or more RED lights on the Front Panel are Blinking

Each RED light indicates a fault condition for the corresponding power module. A fault condition is one or more of the following:

- *Excessive Operating Temp*
- *Excessive Current (Short Circuit)*
- *DC on the Outputs*

An excessive temperature fault can be reset by allowing amp to cool and cycling power on/off button on the front panel. Excessive current (short circuit) can be reset by removing the cause of the short and cycling power on/off button on the front panel. DC at output is a possible fault condition that is equipment related and requires technical assistance. Please contact AV123 if you have repeated problems causing the RED front panel light to flash that are NOT thermal or short circuit related.

### Problems with the whole A/V System

If you are having more complex problems in your overall home entertainment system (not just with the LPA-1 Amplifier, please contact your Emotiva Dealer or AV123 (Exclusive US Distributor) for professional installation assistance. These professionals have years of experience with a wide range of home entertainment and lifestyle products and can offer you assistance in troubleshooting and rectifying problems.

#### **AV123 (Contact Information)**

Toll Free -	(877) 543-7500 (menu option 2)
Website -	<a href="http://www.av123.com">www.av123.com</a> (click on "support")
e-mail -	<a href="mailto:support@av123.com">support@av123.com</a>

# LPA-1 Technical Specifications

<b>Rated Power Output:</b>	(All Channels Driven @ 1Khz, 120VAC/ 60HZ supply, THD noted)
Channels 1-5	<b>125</b> Watts into 8 Ohms (0.04%THD) <b>225</b> Watts into 4 Ohms (0.04%THD)
Channels 6-7	<b>50</b> Watts into 8 Ohms (0.05%THD) <b>95</b> Watts into 4 Ohms (0.05%THD)
<b>Frequency Response:</b>	
20-20Khz:	+/-0.1dB
10-100Khz:	+/-1.0dB
<b>Total Harmonic Distortion (THD):</b>	(80kHz measurement bandwidth)
Channels 1-5:	<0.040%
Channels 6-7:	<0.052%
<b>Signal-to-Noise Ratio:</b>	>100dB, Unweighted (Full Output Reference)
<b>DC Offset:</b>	<1mV
<b>Crosstalk:</b>	>75dB
<b>Damping Factor:</b>	Approximately 200 into 8 Ohms
<b>Input Sensitivity Range (Gain):</b>	
Channels 1-5	29dB
Channels 6-7	26dB
<b>Input Impedance (RCA Input)</b>	47K Ohm
<b>External Trigger Input:</b>	3-12 VDC, center tip of 3.5mm jack is positive
<b>Clearance for ventilation (Back):</b>	Minimum 2" / 50 mm
<b>Electrical Power Requirement:</b>	1200 watts @ 115VAC when driven into 8 Ohms
<b>Electrical Power Consumption:</b>	4 Watts (Standby) and 46 Watts (Idle)
<b>Raw Weight:</b>	63lbs / 28.63kg
<b>Shipping Weight:</b>	70bs / 31.81kg
<b>Dimensions:</b>	17" W x 7.75" H x 19" D 432mm W x 197mm H x 483mm D

## Limited Warranty

The Emotiva LPA-1 has been created to perform flawlessly for many years. As a result of this quality and craftsmanship, Emotiva offers the following warranty to owners of the LPA-1.

Emotiva Audio warrants the LPA-1 to be free from defects in materials and workmanship for a period of **five years** from the original date of purchase. The following items are excluded from, or will void this warranty coverage:

- 1) *Damage to the LPA-1 caused during shipment and handling.*
- 2) *Damage to the LPA-1 caused by accident, misuse or abusive operation contrary to the instructions specified within this manual.*
- 3) *LPA-1 units that have had the serial numbers defaced, modified, or removed.*
- 4) *Damage to the LPA-1 resulting from a modification of, or attempted repair by any person or company not authorized by Emotiva.*
- 5) *Any LPA-1 unit purchased from a non-authorized dealer.*
- 6) *Emotiva does not assume liability for loss of use, or damage to, associated or connected equipment.*

### Service Assistance for the LPA-1

Please note that BEFORE sending your LPA-1 in for repair, you MUST call Emotiva and obtain a return authorization (R/A) number. Before contacting Emotiva to begin the R/A process, please have as detailed a description of the problem(s) you are experiencing and the conditions under which the problem(s) occur. Additionally, please be sure to check the troubleshooting guide in this manual to rule out the possibility of something simple you may have overlooked. If you purchased your unit from AV123, please contact them for an R/A number. Please remember, this is a complicated product and most instances of perceived product failure are the result of improper set up or operation. Emotiva and its dealers will help you ascertain whether you have an operational problem or product defect.

Once you have obtained the R/A number, you must print this clearly on the outside of the box so it will be possible to determine from whom the LPA-1 came once it arrives. Parcels arriving without an R/A number will be refused and returned freight collect.

If you purchased your unit from AV123, please contact them for an R/A number:

#### **AV123 (Contact Information)**

Toll Free - (877) 543-7500 (menu option 2)  
 Website - [www.av123.com](http://www.av123.com)  
 e-mail - [support@av123.com](mailto:support@av123.com)

If you purchased your unit directly from Emotiva or from an authorized Emotiva Dealer, please send your repairs with R/A number to:

#### **Emotiva**

Attn.: Repair Department  
 106 Mission Court, Suite 101  
 Franklin, TN. 37067  
 Reference - (Put your R/A number in this spot)

### Emotiva Disclosure

Copyright 2005 Emotiva

All Rights Reserved. Emotiva reserves the right to make improvements to its products at any time. Therefore, the specifications of the product and the specific details of this manual are subject to change at any time.

# EMOTIVA

**Emotiva**

106 Mission Court, Suite 101  
Franklin, TN. 37067

Toll Free - (877) EMO-TECH  
Website - [www.emotivaaudio.com](http://www.emotivaaudio.com)

***Distributed Exclusively in the US by:***

**AV123**

2150 W. 6th Ave, Suite L  
Broomfield, CO 80020

Toll Free - (877) 543-7500  
Website - [www.av123.com](http://www.av123.com)  
e-mail - [info@av123.com](mailto:info@av123.com)