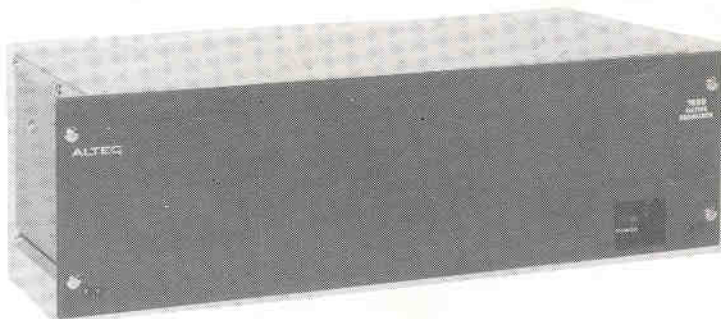

OPERATING
INSTRUCTIONS

OPERATION

The ALTEC 1650 Active Equalizer is an Acousta-Voicing* filter set equipped with 28 active, band-rejection filters and additional high/low pass filter selection to accurately equalize the entire audio spectrum of one sound system channel. The 1650 enables adjustment of the sound system so that the loudspeaker and enclosed room environment provide a flat acoustical response for the listener's ear. Internal gain correction restores the equalized output to the original input level.

Controls and Indicators

All normal operating controls and the pilot indicator are located on the front panel. Control functions are described in Table I. A hinged control cover prevents inadvertent control changes. When the hinged cover is secured, only the POWER switch/pilot indicator is exposed.

The filter controls are continuously variable slide potentiometers, detented in increments of 1-1/2 dB. ALTEC strongly recommends that only the detented positions be used so that precision resetting of the controls can be guaranteed. Typical sound system response curves before and after equalization are shown in Figures 1 and 2. A convenient method of recording filter control settings for future resetting of controls for different installations or applications is shown in Figure 3.

The first attempt to smooth the house curve should be limited to one or two of the greatest peaks or valleys. After this initial smoothing, run a new house curve to check results. Continue adjusting one or two sections at a time, replotting the frequency response each time, until the desired uniformity of response is

*The exclusive ALTEC Acousta-Voicing process is patented under Pat. No. 3,624,298

Table I. Operating Controls and Features

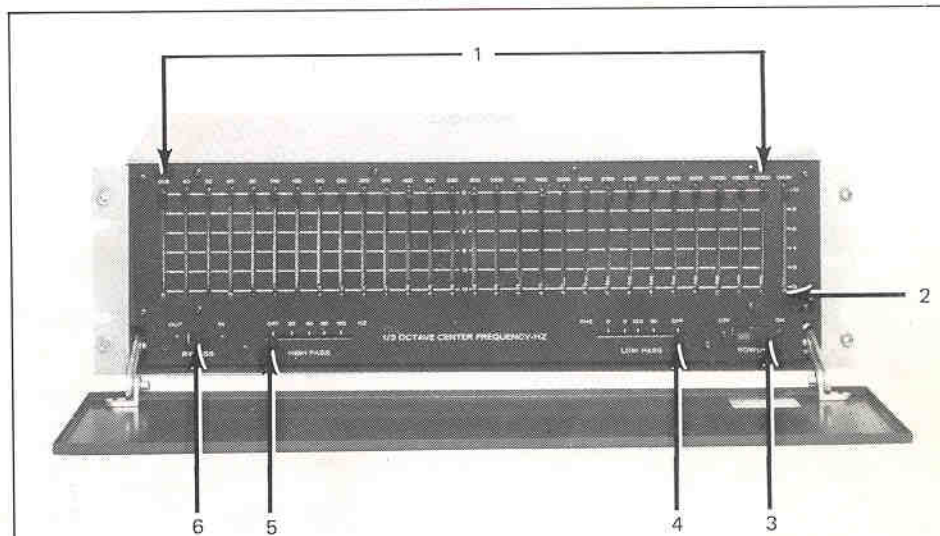

Item	Name	Function/Description
1	Filter Controls	Adjust 1/2-octave band-rejection filters. Twenty-eight linear, continuously variable slide controls, graduated from 0 to -15 dB, detented in increments of 1 1/2 dB. ISO center frequencies range from 31.5 to 16,000 Hz. Filter depth is -15 dB on each center frequency, combining with adjacent filters at -7 dB.
2	GAIN Control	Adjusts output level of equalized program to match input level of unequalized program. Maximum available gain is 20 dB.
3	POWER OFF-ON Switch	Applies primary ac power when depressed to ON position. Pilot light in switch illuminates when power is on.
4	LOW PASS Filter Control	Adjusts low pass filter to shape high-frequency portion of audio spectrum. Continuously variable slide control, graduated from 5 to 20 kHz. Rolloff is 18 dB/octave at the selected corner frequency.
5	HIGH PASS Filter Control	Adjusts high pass filter to shape low-frequency portion of audio spectrum. Continuously variable slide control, graduated from 20 to 160 Hz. Rolloff is 18 dB/octave at the selected corner frequency.
6	BYPASS OUT-IN Switch	Enables the 1650 to be conveniently switched in and out of the sound system channel. Useful for A/B comparison. Slide type switch inserts the 1650 into the sound system channel when moved to the OUT position.

Specifications and components subject to change without notice. Overall performance will be maintained or improved.

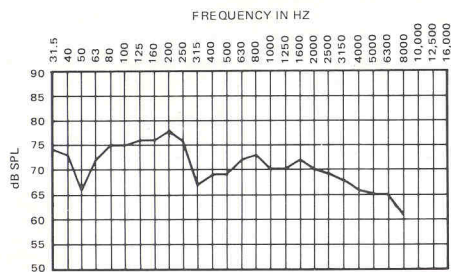

Figure 1. Typical Sound System Response Curve Before Equalization

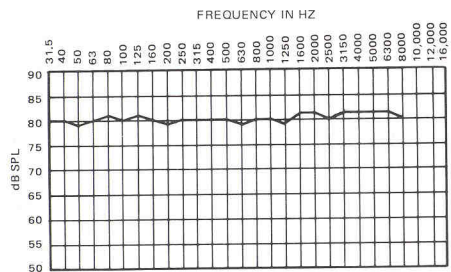

Figure 2. Typical Sound System Response Curve After Equalization

achieved or until correction capability of the 1650 is exceeded.

After the best obtainable house curve is achieved with the 1650 filter controls, adjust the GAIN control to provide an equalized output level as high as the unequalized input level. The GAIN control is detented in increments of 2 dB and has a reinsertion range of +20 dB.

INSTALLATION

Rack Mounting

The 1650 may be mounted in a standard 19-inch equipment rack, or installed in the 42625 or 42526 Cover Accessory with other ALTEC equipment. Vertical space required for mounting is 5 1/4".

Remove four screws securing the front cover; open and lower cover. Install the 1650 in the equipment rack, using the appropriate four screws supplied. Close the front cover and secure with the four screws previously removed.

Ventilation

If the 1650 is mounted in an equipment rack or cabinet with heat-producing equipment, be sure that environmental operating temperature does not exceed 55°C (131°F).

120 Volt, 50/60 Hz Power Connections

Equipment supplied for domestic use is provided with the power transformer primary strapped for 120 volts. The voltage rating nameplate, on the rear of the chassis above the power cord (see illustration of Table II), is mounted to show the appropriate side specifying the connections. Verify that line voltage is in accordance with the voltage rating *before* connecting the 1650 to line power.

240 Volt, 50/60 Hz Power Connections

Export equipment, specified, is provided with the power transformer primary

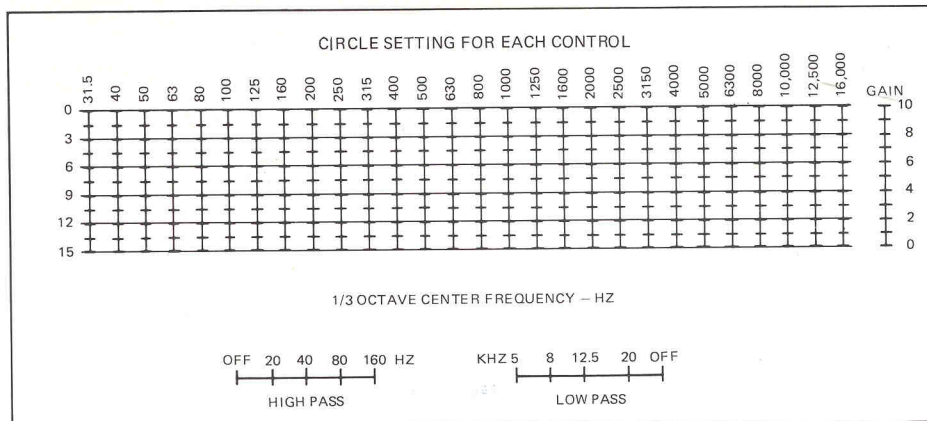

Figure 3. Control Settings Record

strapped for 240 volts. The voltage rating nameplate, on the rear of the chassis above the power cord (see illustration of Table II), is mounted to show the appropriate side specifying the connections.

If the 1650 is to be powered from a 240 volt, 50/60 Hz line, proceed as follows to

change factory wiring of the primary power circuit from 120 volts to 240 volts:

1. Remove seven screws securing top cover; lift off cover.
2. Locate terminal board TB103 on the rear panel of the chassis, behind transformer T102 (see Figure 4).

Table II. Rear Panel Controls and Features

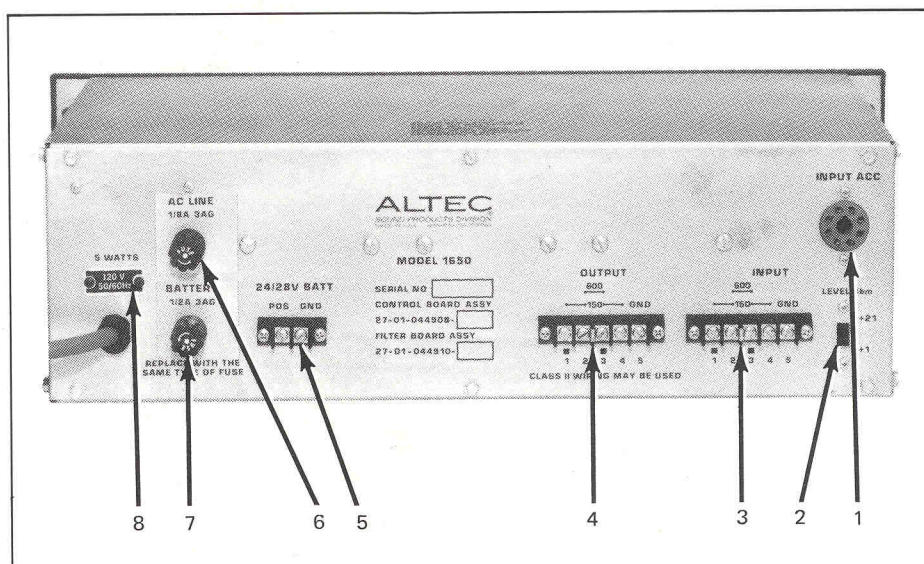

Item	Name	Function/Description
1	INPUT ACC receptacle	Accepts appropriate plug-in accessory to accommodate input circuitry for desired application. Accessories include 15356A Matching Transformer, 15335A Transformer, and the 8080B Pink Noise Generator.
2	LEVEL dBm switch	Selects either +1 or +21 dBm operating mode of 1650 in accordance with input program material.
3	INPUT terminal board	Connects 1650 to 150-ohm or 600-ohm source.
4	OUTPUT terminal board	Connects 1650 to 150-ohm or 600-ohm load.
5	24/28V BATT terminal board	Connects external battery power supply for auxiliary operation or standby switchover. Chassis negative ground.
6	AC LINE power fuse	Protects against excessive current drain from line power source. Replace with same type 1/8A slo-blo fuse (see Parts List).
7	BATTERY power fuse	Protects against excessive current drain from external battery. Replace with same type 1/2A fuse (see Parts List).
8	Voltage Rating Plate	Specifies primary voltage rating for indicated option: 120V ac, 50/60 Hz; or 240V ac, 50/60 Hz. Plate reversible in event of field modification.

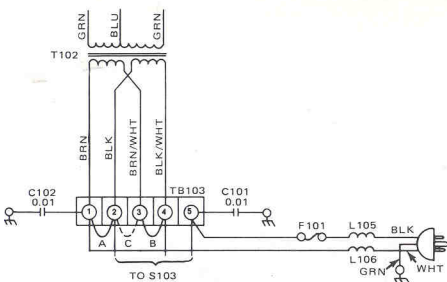

Figure 4. Converting to 240V, 50/60 Hz Power

3. Remove strap 'A' connecting terminals 1 and 2, and remove strap 'B' connecting terminals 3 and 4; then solder strap 'C' to terminals 2 and 3 as indicated in Figure 4.
4. Remove voltage rating plate from chassis; reverse and reinstall to show 240V rating.
5. Install bottom cover on chassis, using seven screws previously removed.

Battery Connections

If desired, the 1650 may be connected to an external 24/28V battery with minus (-) as ground. Terminals for the dc power connections are on TB104 (see Table 2).

If ac power fails, transfer to dc power is instantaneous, automatic and silent. The battery power supply is not operated by the POWER OFF-ON switch at the front panel of the 1650. If switching of battery power is desired, an external relay or switch should be provided by the user.

Input Connections

Input connections to the 1650 are made at the INPUT terminal board (TB101) at the rear of the chassis (see Table 2). Connections should be made with two-conductor twisted and shielded cable, such as Belden 8450 or 8451 cable.

150-Ohm and 600-Ohm Input Connections

As shipped from the factory, the 1650 is strapped for direct (unbalanced) input at the INPUT ACC receptacle at the rear of the chassis (pins 1 and 7).

For 600-ohm unbalanced input applications with the 1650, connect signal source to terminals 1 and 4 of TB101, and strap terminals 4 and 5 (see Figure 5A).

For balanced operation, the strap must be removed from the INPUT ACC receptacle, and replaced by the 15356A Line Matching Transformer accessory (see Table 2).

For 600-ohm balanced input applications with the 1650, connect signal source to terminals 1 and 4 of TB101, and strap terminals 2 and 3 (see Figure 5B). Connect the shield to chassis ground at terminal 5.

For 150-ohm balanced input applications with the 1650, connect signal source to terminals 1 and 4 of TB101, strap terminals 1 and 2, and strap terminals 3 and 4 (see Figure 5C). Connect the shield to chassis ground at terminal 5.

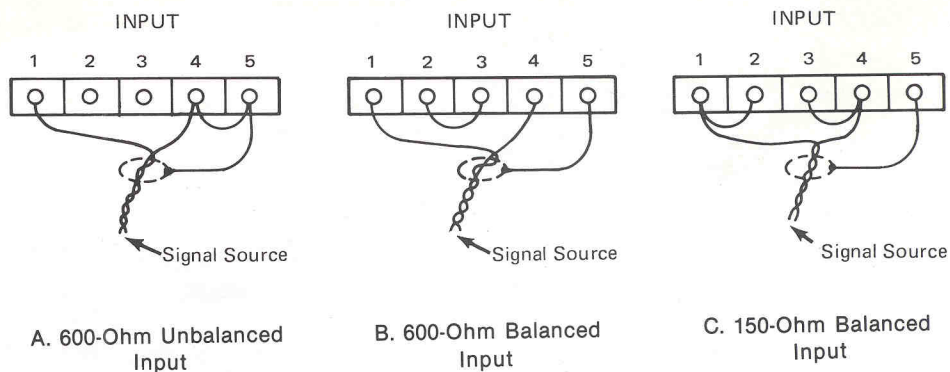

Figure 5. Input Connections at TB101

15,000-Ohm Input Connections

For 15,000-ohm balanced input applications with the 1650, connect the signal source to terminals 1 and 4 of TB101 (see Figure 6). Connect the shield to chassis ground at terminal 5. For unbalanced input, connect additional strap to terminal 5 as shown.

Remove the seven screws securing the top cover, lift off the cover and locate resistor R1 on the filter circuit board assembly (see Figure 6). Remove resistor R1 from the circuit by cutting one or both leads. This modification changes the input impedance of the 1650 to approximately 15,000 ohms.

To complete the circuit for the 15,000-ohm input application, the 15335A Line Matching Transformer accessory must be plugged into the INPUT ACC receptacle at the rear of the chassis (see Table 2).

8080B Pink Noise Generator Connections

Substitution of the 8080B Pink Noise Generator for the input transformer (plugged into the INPUT ACC receptacle at the rear of the chassis) of the 1650 provides convenient flexibility in tailoring the audio spectrum within various acoustic environments. While the 8080B is being used, no connections are required at the INPUT terminal board (TB101); normal input connections become open-circuit.

NOTE

The LEVEL dBm switch on the rear of the chassis must be moved to the +21 position to prevent clipping of noise peaks.

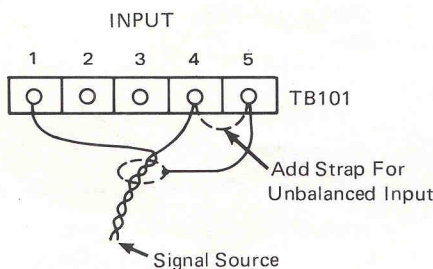

Figure 6. 15,000-Ohm Input Connections

Output Connections

Output connections from the 1650 are made at the OUTPUT terminal board (TB102) at the rear of the chassis (see Table 2). Terminal connections and cable requirements are the same as described for input connections, except that 15,000-ohm connections do not apply, and no plug-in transformer accessory is required.

SERVICE

This service information is for the use of authorized warranty stations only. Service must be performed by an ALTEC Qualified Service Representative.

NOTICE

REPAIR PERFORMED BY OTHER THAN AUTHORIZED WARRANTY STATIONS OR OTHER QUALIFIED PERSONNEL SHALL VOID THE WARRANTY PERIOD OF THIS UNIT. TO AVOID LOSS OF WARRANTY, SEE YOUR NEAREST ALTEC AUTHORIZED DEALER.

For factory service, ship the 1650 prepaid to:

Customer Service
ALTEC
131 West Katella Avenue
Anaheim, California 92803

For additional information or technical assistance, call (714) 774-2900 or Telex 65-5415.

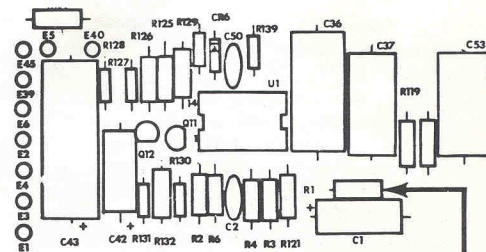

Cut resistor R1 from filter circuit board assembly to change input impedance to approximately 15,000 ohms

Internal Fuse

A fuse, located beneath ac line power transformer T102 on the filter circuit board assembly, protects the dc power supply from excessive current drain. The fuse is accessible when the top cover is removed from the chassis (see Figure 7). Replace only with the same type 1/2-ampere fuse (see Parts List).

Notch Filter Alignment

An alignment potentiometer is provided for each of the 28 notch filters. The alignment potentiometers compensate for slight variations of the corresponding filter control potentiometers. The following procedure is recommended to check or adjust the alignment potentiometers.

1. Remove four screws securing front cover; open and lower cover.
2. Move all filter controls and GAIN control to full upward position. Move LOW PASS and HIGH PASS filter controls to OFF. Move BYPASS switch to OUT. Move LEVEL dBm switch to +21 position. Transformer accessory must be plugged in.
3. Remove seven screws securing top cover to chassis; lift off cover.
4. Apply 100 Hz signal at a level of +10 dBm to terminals 1 and 4 of INPUT TB101.
5. Move POWER switch to ON.
6. Refer to Table 3 for check points. Locate appropriate resistors for associated notch frequencies and check level (-50 dBm or less) at sides of resistors where circuit board traces lead to connector J1. As necessary, adjust the associated alignment potentiometers listed in Table 3 for null.
7. When alignment is completed, install top cover and secure with seven screws.

Control PCB Assembly

To remove the control PCB assembly for replacement of one or more filter control potentiometers, proceed as follows:

1. Remove four screws securing front cover; open and lower cover.
2. Pull off all (31) filter control 'knobs'.
3. Remove seven screws securing top cover and seven screws securing bottom cover; lift off covers.
4. Remove four screws, located at each corner of control panel, to free panel from rear chassis.
5. Using one hand to restrain filter circuit board at base of connector, carefully rock panel assembly (end to end) to disconnect 80-terminal connector. Front panel assembly may now be removed from chassis to extent permitted by wiring.

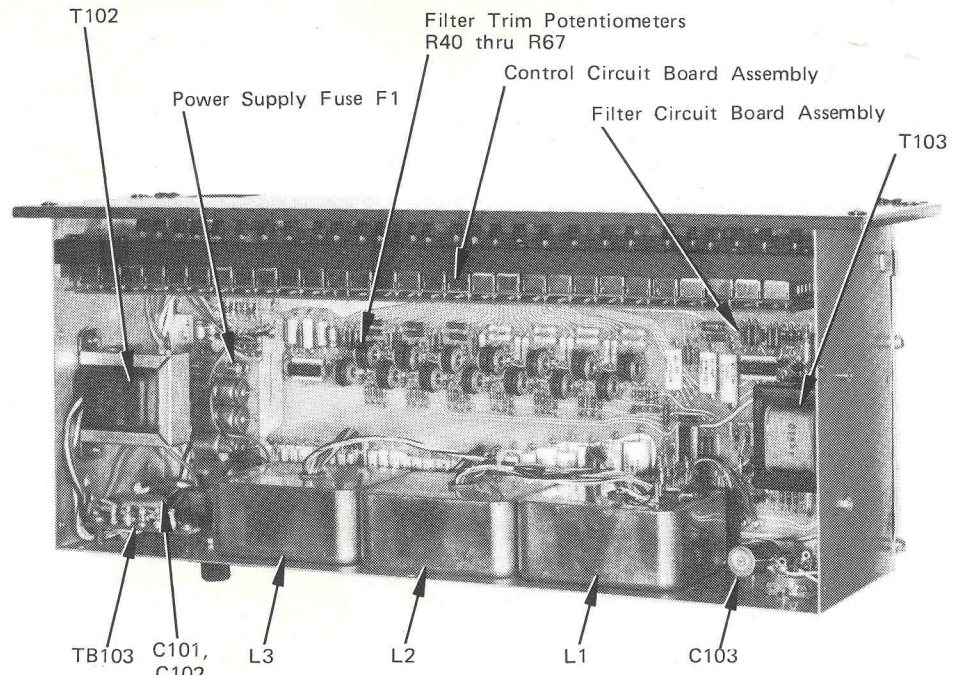

Figure 7. Internal View of 1650 Active Equalizer

Table 3. Notch Filter Check Points and Adjustments

Notch Frequency	4.12 K Ω Check Point (J1 Side)	Alignment Potentiometer
31.5	R70	R40
40	R77	R47
50	R84	R54
63	R91	R61
80	R71	R41
100	R78	R48
125	R85	R55
160	R92	R62
200	R72	R42
250	R79	R49
315	R86	R56
400	R93	R63
500	R73	R43
630	R80	R50
800	R87	R57
1000	R94	R64
1250	R74	R44
1600	R81	R51
2000	R88	R58
2500	R95	R65
3150	R75	R45
4000	R82	R52
5000	R89	R59
6300	R96	R66
8000	R76	R46
10,000	R83	R53
12,500	R90	R60
16,000	R97	R67

6. Remove two screws at lower corners of filter control board to free board from standoffs. Remove four screws along top of panel, and two screws located directly above the BYPASS and POWER switches.
7. The filter circuit board assembly may now be separated from the front panel. If R1, R14, R22 or R29 is to be replaced, the corresponding mounting brackets must be removed from the potentiometer housing.
8. When service is completed, install circuit board by reversal of removal procedure.

Filter PCB Assembly

1. Remove seven screws securing top cover, and seven screws securing bottom cover; lift off covers.
2. Most components are accessible for service. If greater access is required, free front panel from chassis by completing steps 1 through 5 of 'Control PCB Assembly' procedure.
3. Seven screws secure the filter PCB assembly to chassis brackets; these may be removed to allow the circuit board to be removed from the chassis to the extent permitted by wiring.

CAUTION

Replacement of the complete circuit board assembly is not recommended. If necessary to unsolder wiring, be sure to tag all wires according to position to facilitate later reconnection.

4. When service is complete, reverse procedure to restore the unit.

**PARTS LIST
MAIN CHASSIS**

Reference Designator	Ordering Number	Name and Description
—	24-04-112147-01	Knob, filter control
A1	27-01-044910-01	Filter PCB assembly
A2	27-01-044907-01	Control PCB assembly
C101,102	15-02-100089-01	Cap., 0.01 μ F \pm 20%, 1400V
C103	15-01-114213-01	Cap., 470 μ F, 40V
F101	51-04-109226-01	Fuse, 1/8 ampere, 3AG, slo-blo
F102	51-04-100463-01	Fuse, 1/2 ampere, 3AG
L1	56-01-018215-01	Choke, inductor assembly
L2	56-01-018216-01	Choke, inductor assembly
L3	56-01-018217-01	Choke, inductor assembly

Reference Designator	Ordering Number	Name and Description
L101,102	56-01-043100-01	Choke, ferrite bead
L103,104, 105,106	56-01-043100-01	Choke, ferrite bead
S101,102	51-02-118703-01	Switch, DPDT, slide
S103	51-02-113986-02	Switch, DPDT, lighted rocker
T102	56-08-007606-01	Transformer, power
T103	56-07-016810-01	Transformer, output
TB101,102	21-04-121378-01	Terminal board, 5-terminal
TB104	21-04-121377-01	Terminal board, 2-terminal

CONTROL PCB ASSEMBLY

Reference Designator	Ordering Number	Name and Description
R1 thru R28 R29	47-06-121298-01 47-06-113123-01	Pot., 5 K Ω , K taper Pot., 20 K Ω , slide w/detents

Reference Designator	Ordering Number	Name and Description
R30 R31	47-06-121299-02 47-06-121300-02	Pot., 20 K Ω , slide E taper quad Pot., 50 K Ω , slide E taper quad

FILTER PCB ASSEMBLY

Reference Designator	Ordering Number	Name and Description
C1,42	15-01-108543-01	Cap., 5 μ F, 25V
C2,31,32, 33,34,35	15-02-107455-01	Cap., 47 pF \pm 10%, 100V
C3	15-06-121387-01	Cap., 0.63 μ F \pm 2%, 100V
C4	15-06-121361-01	Cap., 0.25 μ F \pm 2%, 100V
C5	15-06-121357-01	Cap., 0.1 μ F \pm 2%, 100V
C6	15-06-121353-01	Cap., 0.04 μ F \pm 2%, 100V
C7	15-06-121349-01	Cap., 0.016 μ F \pm 2%, 100V
C8	15-06-121345-01	Cap., 0.0063 μ F \pm 2%, 100V
C9	15-06-121341-01	Cap., 0.0025 μ F \pm 2%, 100V
C10	15-06-121388-01	Cap., 0.5 μ F \pm 2%, 100V
C11	15-06-121360-01	Cap., 0.2 μ F \pm 2%, 100V
C12	15-06-121356-01	Cap., 0.08 μ F \pm 2%, 100V
C13	15-06-121352-01	Cap., 0.0315 μ F \pm 2%, 100V
C14	15-06-121348-01	Cap., 0.0125 μ F \pm 2%, 100V
C15	15-06-121344-01	Cap., 0.005 μ F \pm 2%, 100V
C16	15-06-121340-01	Cap., 0.002 μ F \pm 2%, 100V
C17	15-06-121389-01	Cap., 0.4 μ F \pm 2%, 100V
C18	15-06-121359-01	Cap., 0.16 μ F \pm 2%, 100V
C19	15-06-121355-01	Cap., 0.063 μ F \pm 2%, 100V
C20	15-06-121350-01	Cap., 0.025 μ F \pm 2%, 100V
C21	15-06-121347-01	Cap., 0.01 μ F \pm 2%, 100V
C22	15-06-121343-01	Cap., 0.004 μ F \pm 2%, 100V
C23,39	15-06-121339-01	Cap., 0.0016 μ F \pm 2%, 100V
C24	15-06-121362-01	Cap., 0.315 μ F \pm 2%, 100V
C25	15-06-121358-01	Cap., 0.125 μ F \pm 2%, 100V
C26	15-06-121354-01	Cap., 0.05 μ F \pm 2%, 100V
C27	15-06-121350-01	Cap., 0.02 μ F \pm 2%, 100V
C28	15-06-121346-01	Cap., 0.0063 μ F \pm 2%, 100V
C29	15-06-121342-01	Cap., 0.00315 μ F \pm 2%, 100V
C30	15-06-121338-01	Cap., 0.00125 μ F \pm 2%, 100V
C36	15-06-121364-01	Cap., 0.56 μ F \pm 2%, 100V
C37,53	15-06-121363-01	Cap., 0.4 μ F \pm 2%, 100V
C38	15-06-121383-01	Cap., 680 pF \pm 2%, 100V
C40	15-06-121384-01	Cap., 0.0027 μ F \pm 2%, 100V
C41,44,45	15-06-112120-01	Cap., 47 μ F, 25V
C43	15-01-112804-01	Cap., 470 μ F, 25V
C46,47,48, 49	15-01-114213-01	Cap., 470 μ F, 40V
C50,51,52, 54,55	15-02-100307-01	Cap., 0.01 μ F \pm 20%, 100V
CR2,3,4,5,6	48-01-100881-02	Diode, stabilizer, STB 567
CR7,8,9,10, 11,12,13	48-02-042787-01	Rect., silicon, 1A, 400 PIV, 1N4004
F1	51-04-119188-01	Fuse, 1/2 ampere, 3AG, 250V
Q3,5,7,9,11	48-03-121306-01	Transistor, 2N3904
Q4,6,8,10,12	48-03-107102-01	Transistor, 2N3906
Q13	48-03-107447-03	Transistor, 2N5320, selected
Q14	48-03-121251-01	Transistor, FET, MPF 4393
R1	47-01-102259-01	Res., 620 Ω \pm 5%, 1/2W
R2,126	47-03-121308-01	Res., 909 Ω \pm 1%, 1/8W

Reference Designator	Ordering Number	Name and Description
R3,4,6,125, 142 thru 149	47-03-119545-01	Res., 8.25 K Ω \pm 1%, 1/8W
R5,6,7,8,39, 100,105, 110,114, 120	47-01-102100-01	Res., 8.2 K Ω \pm 5%, 1/4W
R9,38,70 thru 99, 103,104, 108,109	47-03-108444-01	Res., 4.12 K Ω \pm 1%, 1/4W
R10	47-01-102059-01	Res., 160 Ω \pm 5%, 1/4W
R11	47-01-102070-01	Res., 470 Ω \pm 5%, 1/4W
R12,13,18, 33	47-01-102072-01	Res., 560 Ω \pm 5%, 1/4W
R14,19,25, R15,16,21, 22,28,29, 30,35,36, 37	47-01-102073-01 47-01-102074-01	Res., 620 Ω \pm 5%, 1/4W Res., 680 Ω \pm 5%, 1/4W
R17	47-01-102062-01	Res., 220 Ω \pm 5%, 1/4W
R20	47-01-102071-01	Res., 510 Ω \pm 5%, 1/4W
R23	47-01-102075-01	Res., 750 Ω \pm 5%, 1/4W
R24,27,31, 34	47-01-102069-01	Res., 430 Ω \pm 5%, 1/4W
R40 thru 67	47-05-108937-02	Pot., 2.2 K Ω \pm 20%, 1/4W
R68,69,101, 102,106, 107,111, 112,130, 131	47-01-102030-01	Res., 10 Ω \pm 5%, 1/4W
R113,134, 139,140, 141,150	47-01-102040-01	Res., 27 Ω \pm 5%, 1/4W
R115	47-01-102108-01	Res., 18 K Ω \pm 5%, 1/4W
R116	47-01-102064-01	Res., 270 Ω \pm 5%, 1/4W
R117	47-01-102090-01	Res., 3.3 K Ω \pm 5%, 1/4W
R118	47-03-121330-01	Res., 1.91 K Ω \pm 1%, 1/4W
R119,121	47-03-119016-01	Res., 3.83 K Ω \pm 1%, 1/4W
R122,123, 124	47-03-121329-01	Res., 3.16 K Ω \pm 1%, 1/4W
R127,128	47-01-109092-01	Res., 3.9 K Ω \pm 5%, 1/4W
R129,132	47-01-102232-01	Res., 47 Ω \pm 5%, 1/2W
R133	47-01-102208-01	Res., 4.7 Ω \pm 5%, 1/2W
R135	47-01-102056-01	Res., 120 Ω \pm 5%, 1/4W
R136,137, 138	47-01-102131-01	Res., 150 K Ω \pm 5%, 1/4W
R151	47-01-102262-01	Res., 820 Ω \pm 5%, 1/2W
U1,2,3,4,5	17-01-121305-01	Int. ckt., op. amp., RC4136DP

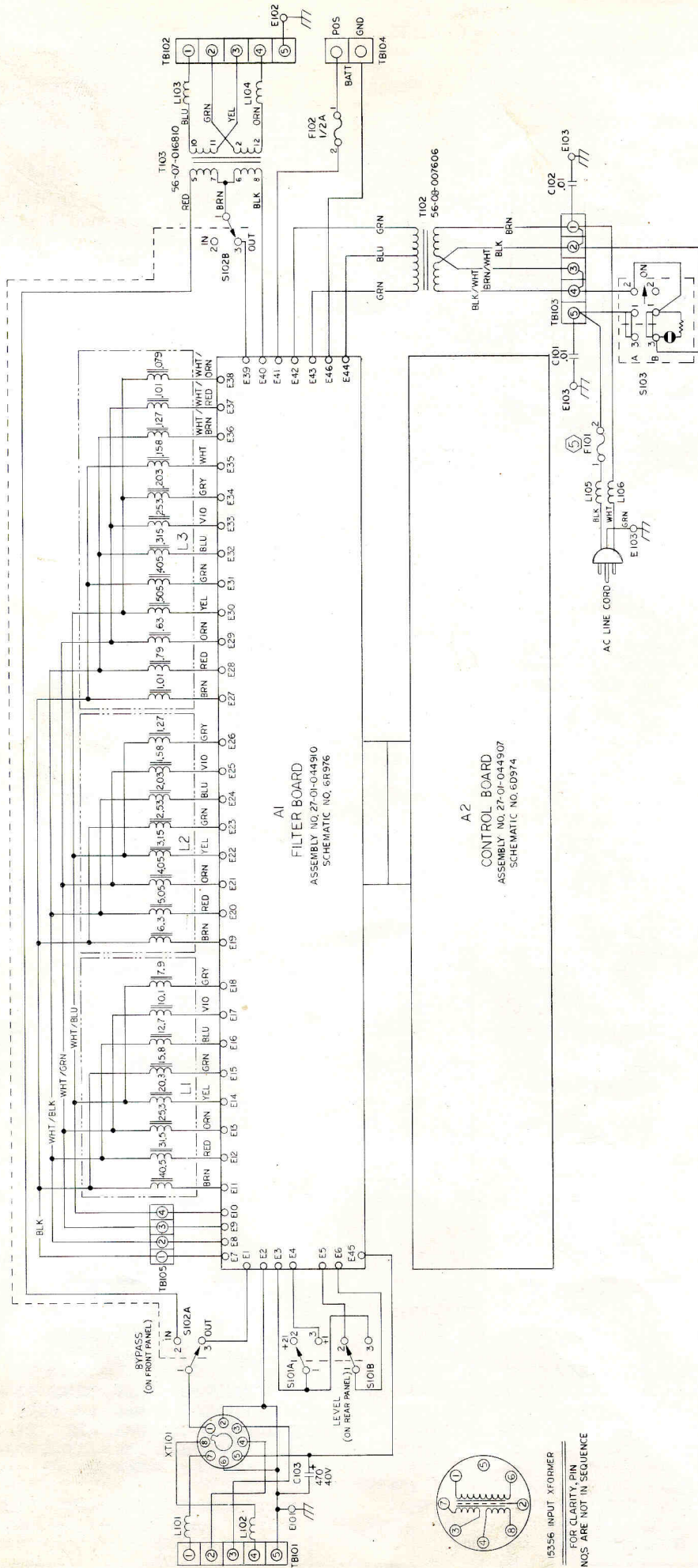
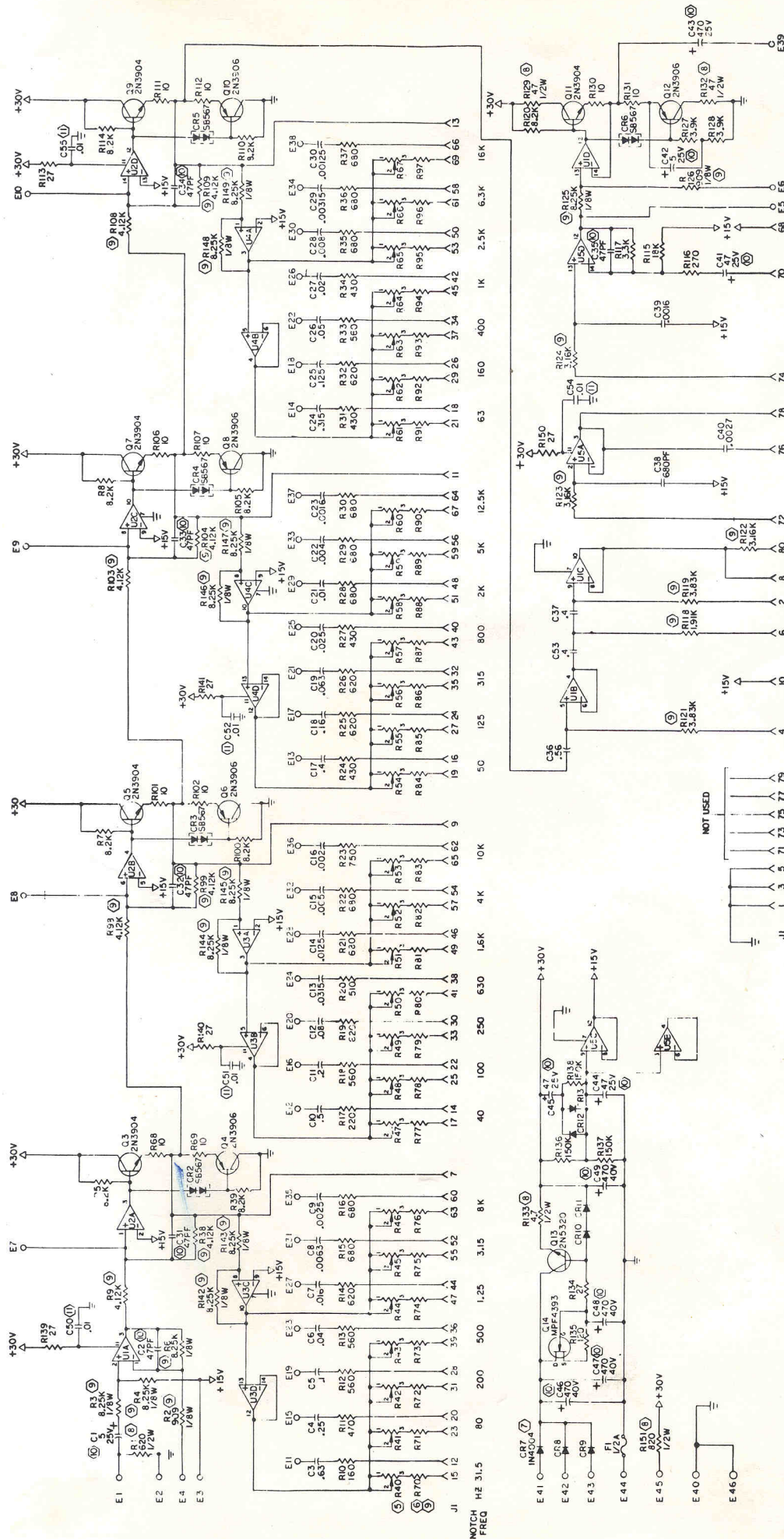

Figure 8. Schematic (6D967-99), Interconnecting Diagram



- NOTCH PREC
- 1 CAPACITORS ARE $\pm 20\%$
 2 RESISTORS ARE $\pm 10\%$
 3 RESISTORS ARE $\pm 1\%$
 4 RESISTORS ARE $\pm 5\%$
 5 R70 THRU R73 ARE $1/4W$
 6 R70 THRU R73 ARE $1/2W$
 7 R40 THRU R47 ARE $2.2K$ $1/4W$
 8 ALL CAPACITORS ARE $100V$ VOLTS -
 9 VALUES ARE IN MICROFARADS $\pm 2\%$
 10 ALL RESISTORS ARE $1/4W$ $\pm 2\%$
 11 FOR ASSY DWG SEE 27-01-044910
 12 NOTES UNLESS OTHERWISE SPECIFIED

Figure 9. Schematic (6R976-99), Filter PCB Assembly

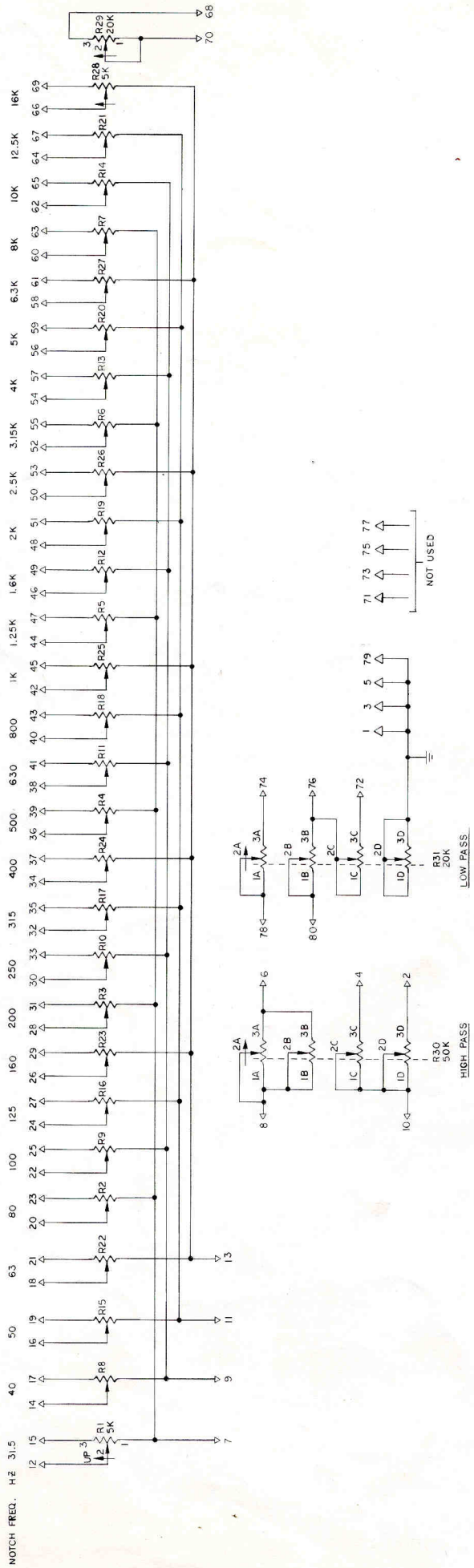

Figure 10. Schematic (6D974-99), Control PCB Assembly