

3-MOTOR 3-HEAD  
STEREO TAPE DECK

# RT-1020L

# RT-1020H

OPERATING INSTRUCTIONS

FU



Walnut veneered side panels are used in the construction of this cabinet.

 PIONEER

This operating instruction booklet is available in common for the operation of both models RT-1020L and RT-1020H, the only difference of which is "Tape running speeds." Please note that "RT-1020L" and "RT-1020H" in the explanations

are referred to as "RT-1020L/H."

RT-1020L	HI: 19cm/s (7-½ ips)
	LO: 9.5cm/s (3-¾ ips)
RT-1020H	HI: 38cm/s (15 ips)
	LO: 19cm/s (7-½ ips)

## WHERE TO PLACE YOUR DECK

Model RT-1020L/H can be operated in upright as well as horizontal position. When selecting the place for your deck, avoid the following conditions as they would affect the machine's performance and lead to trouble:

- Direct sunlight and the vicinity of heaters, etc.
- High humidity, poor ventilation
- Dust and dirt

- The vicinity of electrical appliances that generate magnetism, such as TV sets, motors, transformers, etc.

## IMPORTANT PRECAUTIONS

### Always Keep the Tape Heads Clean

Dirt and tape abrasions on the tape head surfaces can deteriorate the sound quality and lead to other trouble. Make it a habit to always clean the tape heads with the supplied cleaning bar before each use (Fig. 1). For stubborn deposits that the cleaning bar cannot remove, refer to "Care & Maintenance" on page 21.

### Always Use Two Reels of the Same Size

The use of different size reels can obstruct proper tape transport, causing damage to the tape. Always use two reels of the same diameter and, preferably, shape. If one reel is thinner than the other, place the supplied sheet on the reel base for the thinner reel.

### Always Apply the Reel Clamper if the Deck is in Upright Position

Reel clampers to hold the reels in place are built into the tips of the center shafts. Refer to Fig. 2. Place the reel on the shaft, then pull up and twist the tip of the shaft so that its protrusions will hold down the reel. **CAUTION!**

REELS FALLING OFF WHILE IN MOTION CAN BE DANGEROUS.

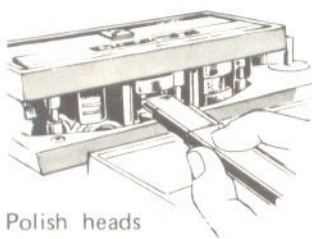

Polish heads carefully

Fig. 1

Pull tip of shaft towards you, then twist.

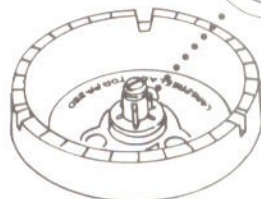

Fig. 2

### NOTE:

This model is to work on 120V AC. However, it can also be adjusted for use on other voltages at Pioneer authorized Service Center. For further information, contact Pioneer Electronic Corp.

## CONTENTS

WHERE TO PLACE YOUR DECK	2
IMPORTANT PRECAUTIONS	2
FEATURES	3
PARTS AND CONTROL FACILITIES	4
ASSEMBLY OF A COMPONENT	
STEREO SYSTEM	7
TAPE DECK CONNECTIONS	7
BASIC OPERATING INSTRUCTIONS	9
PLAYBACK	11
RECORDING	13
LIVE RECORDING WITH	
MICROPHONES	16
4-TRACK MONOPHONIC RECORDING	16
MIXING	17
SOUND-ON-SOUND RECORDING	17
ECHO RECORDING	18
WHEN EMPLOYING DIGITAL TIMER	19
MAGNETIC TAPE	20
CARE & MAINTENANCE	21
KEYS TO SUCCESSFUL RECORDING	
TECHNIQUE	22
TROUBLE-SHOOTING CHART	23
SPECIFICATIONS AND SCHEMATIC	
DIAGRAMS	Enclosed herewith

## FEATURES

### Sturdy Construction to Professional Standards

All mechanical parts are assembled on a chassis made of 5mm thick aluminum of high dimensional precision and supported by a unified diecast frame. This heavy-duty construction gives high accuracy and long durability.

### Precision Tape Transport Can Accommodate 10-inch Reels

The capstan is driven by a 4/8-pole hysteresis synchronous motor with a large 100mm flywheel to maintain superb speed accuracy without wow and flutter. The capstan itself is machined to extremely precise tolerances.

The reels are driven by a pair of specially designed 6-pole inner rotor induction motors which combine the ideal torque characteristics of eddy current motors with the high starting torque of induction motors. No excessive stress is applied to the tapes, thanks to the low rotational inertia of the motors and the solenoid-controlled differential band brakes.

### Three Tape Heads Including 4/2-channel Playback Head

The combined 4/2-channel playback head features highly precise track alignment, intimate tape-to-head contact due to its hyperbolic curvature, and gives excellent performance in regard to phase accuracy, linear frequency response and crosstalk. In the recording head — only 2-channel stereo recording is possible — much attention has been paid to obtain optimum bias, signal-to-noise ratio and frequency response characteristics. The three-head system of course permits professional after-tape monitoring of a recording in progress.

### Direct Coupled Playback Amplifier of Wide Dynamic Range

For each of the four channels, a 3-stage direct coupled amplifier with low-noise silicon transistors is provided. Its dynamic range goes to beyond 20dB above 0VU level. 2-track prerecorded master tapes can be played, too.

### Separate Recording Amplifiers for Line and Mic Inputs

The 2-channel recording amplifier features an excellent signal-to-noise ratio and a wide dynamic range of 50dB. The microphone inputs are sensitive enough to permit the use of studio-quality 600-ohm condenser microphones. To maintain stable recording conditions regardless of AC line voltage fluctuations or temperature changes, a stabilized voltage supply has been adopted, while a bias current limiter has been included in the bias supply oscillator circuit.

Independent level controls for the LINE and MIC inputs

permit effective mixing of program sources, "sing-along" recording, sound-on-sound recording and other professional processing methods.

### Click Noises Prevented by Electronic Switching

Solid state electronic — not mechanical — switches in the recording and playback equalizer circuits and a dynamic relay in the recording bias circuit prevent those unpleasant click noises caused by normal switches.

### 3-position Bias Selector, 2-position Equalizer Selector

To make the best of the extra quality potential of low-noise, high output tape (L.H. tape), proper bias current and equalization are of paramount importance. On model RT-1020L/H, bias current and equalization selector switches have been provided to establish optimum recording conditions for all types of recording tape now on the market.

### Swift-action Electronic Pushbutton Control with Perfect Tape Protection

All transport functions are switched by electronic solenoid pushbuttons. You can switch from any mode directly to any other mode without having to push the stop button and without fear of undue stress on the tape.

### Automatic Recording in Your Absence

The tape deck can be preset for recording and, with the help of an optional timer, can be energized at a preselected time, for example to record an FM program that you do not wish to miss.

### Auxiliary Controls Worthy of a Studio Machine

Tape tension can be changed according to reel size. Other controls include separate record switches for both channels, a "recording" indicator equipped with a light emitting diode, 4-channel/2-channel playback selector, tape/source monitor switches for front and rear channels, a headphone jack, etc.

### Function Begets Form

Outward appearance matches technical excellence — the impressive looking control panel, large-sized LEVEL meters and handsome controls are visual expressions of the high level of technical performance that you can expect from this tape machine.

# PARTS AND CONTROL FACILITIES

## PAUSE SWITCH

For short interruptions of tape travel. In position ON, the tape is stopped while the unit remains in its previous – recording or playback – mode. At OFF, the tape resumes travel at normal speed. Note, however, that the PAUSE switch does not function during fast forward or rewind.

## POWER SWITCH

Push this button to turn the unit ON, push it again and release it to turn the power OFF.

## REEL SIZE SWITCH

Changes tape tension in accordance with reel size. For 7-inch (17cm) or smaller reels, push the button in. When using 10-inch (26cm) reels, release the button. IMPORTANT!

ALWAYS USE TWO REELS OF THE SAME SIZE.

## TAPE SPEED SELECTOR

Pushbutton depressed: LO (low) tape speed.

Pushbutton released: HI (high) tape speed.

To switch from LO to HI, push the button lightly – it will return to released position.

RT-1020L HI: 19cm/s (7-1/2 ips) RT-1020H HI: 38cm/s (15 ips)  
LO: 9,5cm/s (3-3/4 ips) LO: 19cm/s (7-1/2 ips)

## MIC RECORDING LEVEL CONTROL

Controls the recording level of live microphone recordings. Clockwise rotation increases the recording level. This control also governs the recording level when a recording is made through the REC/PB connector (DIN-type) on the rear panel.

## LINE RECORDING LEVEL CONTROL

Controls the recording level that the signal is fed into the INPUT (REC) jacks on the rear panel. Clockwise rotation increases the recording level.

### NOTE:

The MIC and LINE recording level controls both consist of a pair of friction-coupled knobs; the inner knob controls the left channel, the outer ring, the right channel. Usually, knob and ring rotate together, but you can rotate one while holding the other in place with your other hand.

## RECORDING INDICATORS

REC-L: Red light emitting diode lights up when the left channel is in recording mode.

REC-R: Lights up when the right channel is in recording mode.

For stereo recordings, confirm that both indicators are lighted.

## LEVEL METERS

Indicate the recording and playback signal levels.

## MIC INPUT JACKS

Two microphones for stereo recording can be connected here. Low-impedance (600ohms) as well as high-impedance (10k ohms to 50k ohms) can be used, but the cables must have standard 6ϕmm plugs.

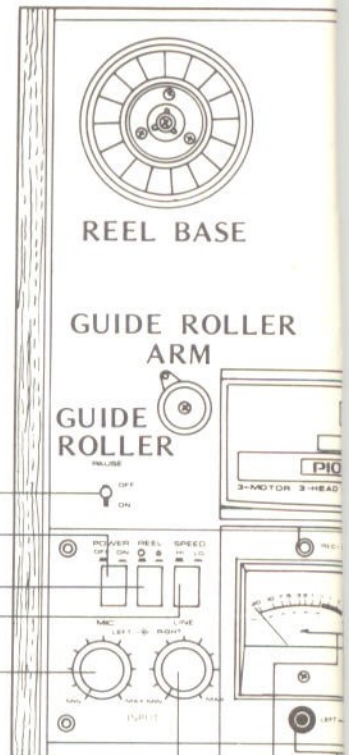

## TAPE COUNTER

Before starting a recording, reset the TAPE COUNTER to "0000" by depressing the reset button. Use of the TAPE COUNTER will make it easy to locate the starting point of a recording.

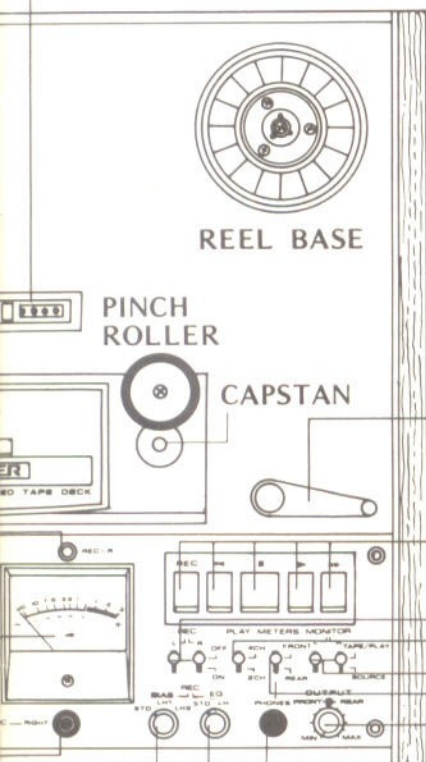

REEL BASE

PINCH ROLLER

CAPSTAN

## REC EQ SWITCH

Selects the recording equalization characteristics in accordance with the type of tape to be used.

STD: For recording on normal, conventional tape.

LH: For recording on low-noise high-output tape.

This switch has no function in playback.

## REC BIAS SWITCH

Selects the proper bias current in accordance with the type of tape to be used.

STD: For recording on normal tape. Smallest bias current.

LH1, LH2: For recording on low-noise high-output tape.

LH2 gives the strongest bias current.

Detailed instructions about the functions of the REC BIAS and REC EQ switches are given on page 14.

## TENSION ARM

Regulates tape tension, but also functions as an automatic shut-off sensor. If the tape is slack, breaks or runs out, the automatic shut-off mechanism stops the tape transport and returns all function buttons to neutral position.

## FUNCTION BUTTONS

- STOP: Stops tape travel from any mode, returns unit to neutral position.
- ▶ PLAY: Makes tape travel at selected speed. For playback, push this button. For recording, push this and the REC button.
- REC: Activates recording circuits. To start a recording, hold this button down while pushing the PLAY button.
- ▶ FAST FORWARD: Makes tape travel at high speed from left to right.
- ◀ REWIND: Makes tape travel at high speed from right to left.

### NOTE:

Unlike inconvenience of some kinds of tape machines on the market, this model helps you switch from one mode of operation to another without pushing the STOP button. That is, there is no need to push the STOP button when switching from either FAST-FORWARD or REWIND mode to another, for instance, you can switch directly to PLAY. Note, however, that such switching operation always stops the tape travel once, momentarily. A few seconds more, and it will soon run at normal speed.

- To go directly from FAST FORWARD or REWIND to PLAY, refer to page 10.
- For using thin tape in thickness, refer to NOTE on page 12.

## OUTPUT LEVEL CONTROL

Controls the output level that recorded tape is played back. This is a friction-coupled type consisting of the inner and outer knobs.

INNER KNOB: FRONT (CH.1, CH.3)

OUTER RING: REAR (CH.2, CH.4)

Usually, knob and ring rotate together, but you can rotate one while holding the other in place with your other hand.

## PHONES JACK

Stereo headphones can be connected here for monitoring or private listening. The METERS switch selects the channels that you hear through the headphones.

## WITH A 2-CHANNEL STEREO AMPLIFIER

### Playback Connections

Connect the OUTPUT (MON) FRONT terminals of the tape deck to the TAPE MON or similar tape inputs of the amplifier, as shown in Fig. 6. Use the supplied phono cables.

- OUTPUT FRONT LEFT — TAPE INPUT (MONITOR) LEFT CHANNEL
- OUTPUT FRONT RIGHT — TAPE INPUT (MONITOR) RIGHT CHANNEL

### Recording Connections

Connect the INPUT (REC) terminals of the tape deck to the TAPE REC or similar tape outputs of the amplifier, as shown in Fig. 6.

- INPUT (REC) LEFT — TAPE REC LEFT CHANNEL
- INPUT (REC) RIGHT — TAPE REC RIGHT CHANNEL

### Connection Through DIN-type REC/PB Connector

If your stereo amplifier is equipped with a DIN-type REC/PB connector (as most modern amplifiers and receivers are), all playback and recording connections can be made by linking this to the REC/PB connector of the RT-1020L/H with a single DIN cable (Fig. 7). Such a cable is available from your Pioneer dealer.

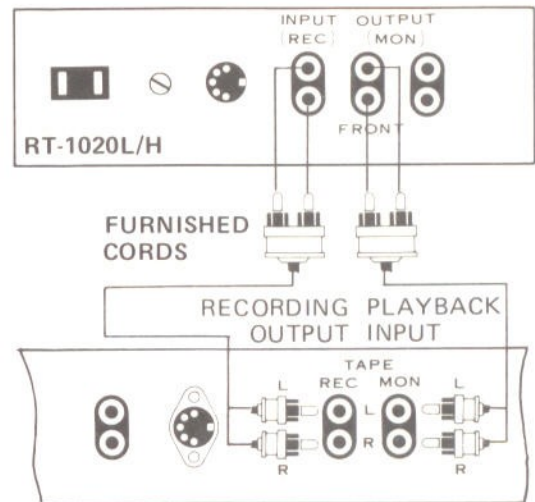

JACKS OF 2-CHANNEL STEREO AMPLIFIER  
Fig. 6

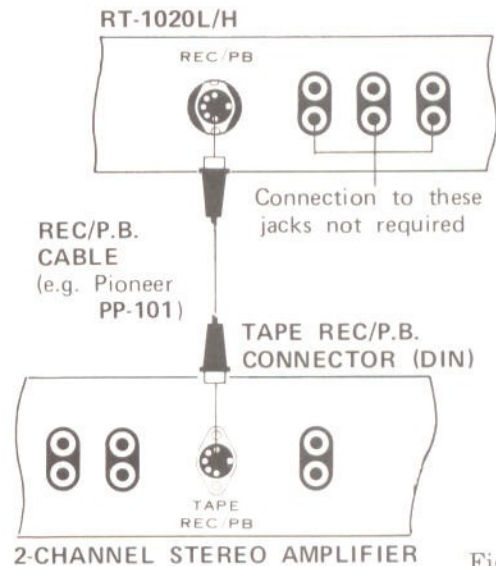

Fig. 7

# ASSEMBLY OF A COMPONENT STEREO SYSTEM

Model RT-1020L/H is capable of 4-channel and 2-channel playback as well as 2-channel recording but incapable of 4-channel recording. When combined with a 4-channel amplifier (such as Pioneer model QA-800A) and speakers, it will give you superlative sound from 4-channel prerecorded tapes. Instead of a 4-channel amplifier, you can also use two 2-channel amplifiers. When connected to only one stereo amplifier, model RT-1020L/H functions as a normal stereo tape deck for recording and playback, as shown in Figs. 3 and 4.

## TAPE DECK CONNECTIONS

### WITH A 4-CHANNEL STEREO AMPLIFIER

Connections between tape deck and amplifier must be made with the supplied phono cables as shown in Fig. 5.

#### Playback Connections

TAPE DECK	AMPLIFIER
OUTPUT FRONT LEFT	— TAPE INPUT
	FRONT LEFT (CH. 1)
OUTPUT FRONT RIGHT	— TAPE INPUT
	FRONT RIGHT (CH. 3)
OUTPUT REAR LEFT	— TAPE INPUT
	REAR LEFT (CH. 2)
OUTPUT REAR RIGHT	— TAPE INPUT
	REAR RIGHT (CH. 4)

#### Recording Connections

Model RT-1020L/H cannot make 4-channel recordings. For 2-channel stereo recording, connect the INPUT (REC) terminals to the amplifier's TAPE REC or similar tape outputs with the supplied phono cables, as shown in Fig. 5. If the amplifier has front and rear channel tape outputs, connect to the front channels unless you specifically want to record the rear channel signals.

#### NOTE:

Connections are basically the same as in using two 2 channel amplifiers.

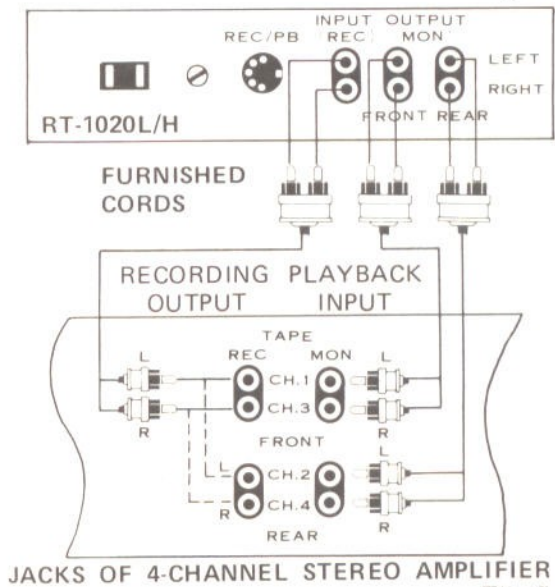
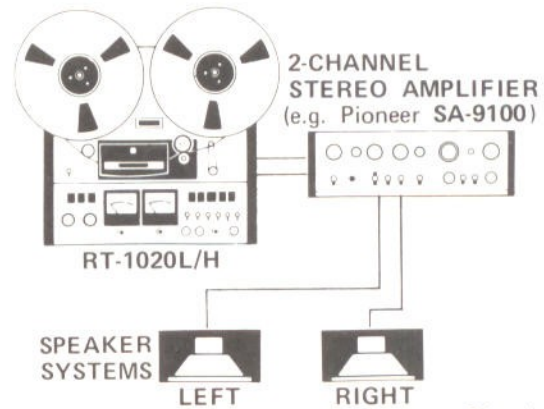
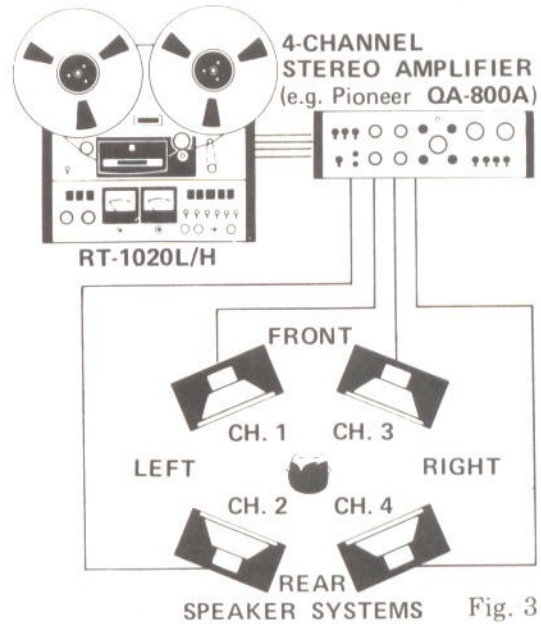

**-REC SWITCHES (L, R)**

To make a recording, one or both of these switches must be set at ON.

- L: Recording on left channel
- R: Recording on right channel

For stereophonic recordings, set both switches at ON.

**-PLAY SWITCH**

Selects 4-channel or 2-channel playback mode.

- 4 CH: Playback of 4-channel recorded tapes
- 2 CH: Playback of 2-channel recorded tapes

**-MONITOR SWITCHES (L, R)**

A recording in progress can be monitored (via speakers or headphones) in either of two ways — the original SOURCE sound, or the recorded TAPE sound as picked up by the playback head. By switching back and forth between positions SOURCE and TAPE/PLAY, you can compare the original sound quality with that of the recording and take corrective action if necessary.

The left switch controls the left channel, the right switch, the right channel.

**-METERS SWITCH**

Selects the channels to be displayed by the level meters (and supplied to the headphone jack) when playing 4-channel recorded tapes.

**FRONT:** Front channels (CH. 1 = left, CH. 3 = right) supplied to level meters and headphones.

**REAR:** Rear channels (CH. 2 = left, CH. 4 = right) supplied to level meters and headphones.

**AC POWER IN**

Connect the AC power cord here.

**GROUND TERMINAL (GND)**

Grounding is not necessarily required, but in the case of hum or externally induced noise, the GND terminal on the amplifier, or directly to earth.

**REC/PB CONNECTOR**

A combined input and output, for 2-channel operation only. If your stereo amplifier has an identical REC/PB connector, you can establish all recording (INPUT), and playback (OUTPUT) connections with a single DIN cable (optional) available from your Pioneer dealer.

Note that if connection is made to the REC/PB connector, the recording level must be controlled with the MIC level controls.

**INPUT (REC) TERMINALS**

For recording, connect these inputs to the TAPE REC or similar outputs of your stereo amplifier by means of the supplied phono cables. Be sure to connect left channel to LEFT, right to RIGHT.

**OUTPUT (MON) TERMINALS**

For playback, connect these outputs to the TAPE MONITOR, TAPE PLAYBACK or similar inputs on your stereo or 4-channel amplifier.

With a 4-channel amplifier:

- FRONT LEFT to FRONT LEFT (CH. 1) of amplifier
- FRONT RIGHT to FRONT RIGHT (CH. 3) of amplifier
- REAR LEFT to REAR LEFT (CH. 2) of amplifier
- REAR RIGHT to REAR RIGHT (CH. 4) of amplifier

With a 2-channel amplifier:

- FRONT LEFT to LEFT CHANNEL of amplifier
- FRONT RIGHT to RIGHT CHANNEL of amplifier

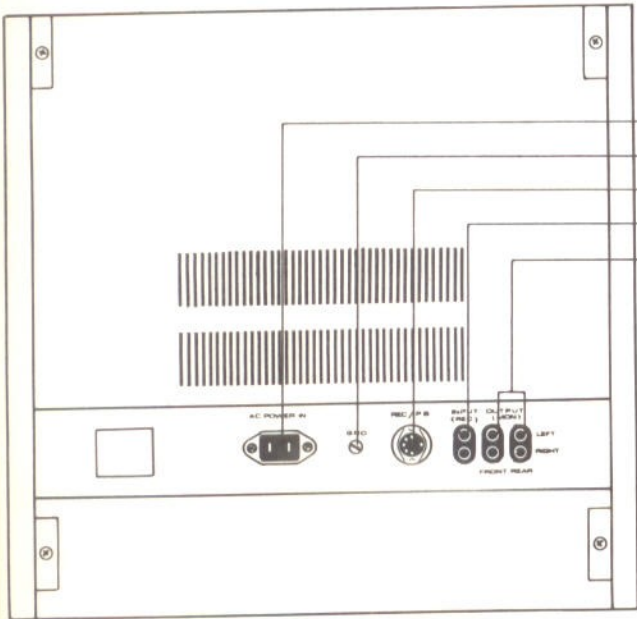

# BASIC OPERATING INSTRUCTIONS

## TAPE THREADING

As described in the foregoing, always use two reels of the same size. You will find it practical to use chiefly 10-inch or 7-inch reels rather than the very small ones.

1. Place the full reel on the left reel base, the empty reel on the right base. When using the supplied or similar 10-inch reels, you also need the supplied reel adaptors. See Fig. 8. These adaptors are not needed with 7-inch or smaller reels.

Differences in reel thickness can be compensated by placing the supplied sheet under the thinner reel as shown in Fig. 9.

2. Secure the reels in place by pulling up the tips of the center shafts and twisting them about 3 to 4mm to the left or right so that their protrusions will hold the reels down. Make it a habit to always secure the reels in this way — unsecured reels could fall off and cause damage (Fig. 10).

3. When using 7-inch or smaller reels, push down the REEL SIZE switch. With 10-inch reels, no need to push it down (Fig. 11).

4. Before threading the tape, lock the guide roller arm, as shown in Fig. 12. This locking mechanism is provided for convenience in threading the tape. Then thread the tape as shown in Fig. 13. Be sure to insert the leading end of the tape correctly into the take-up reel slot, since if it is not properly secured, slippage may occur when the tape is running. Turn the reel 3 or 4 revolutions to take up any tape slack.

Do not forget to release the guide roller arm lock before running the tape.

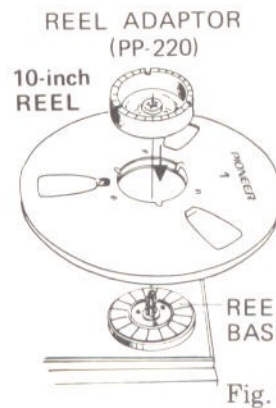

Fig. 8

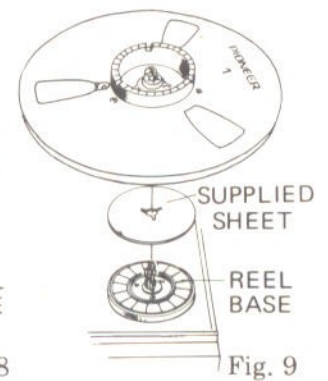

Fig. 9

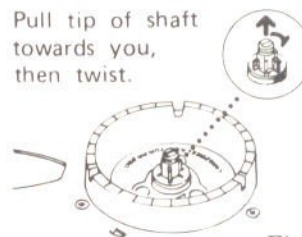

Fig. 10



Fig. 11

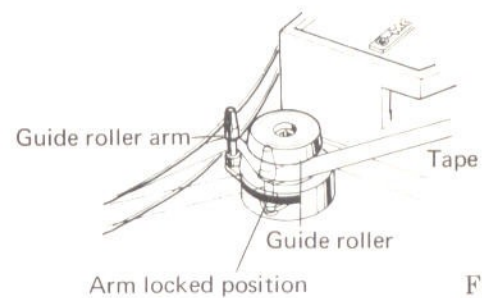

Fig. 12

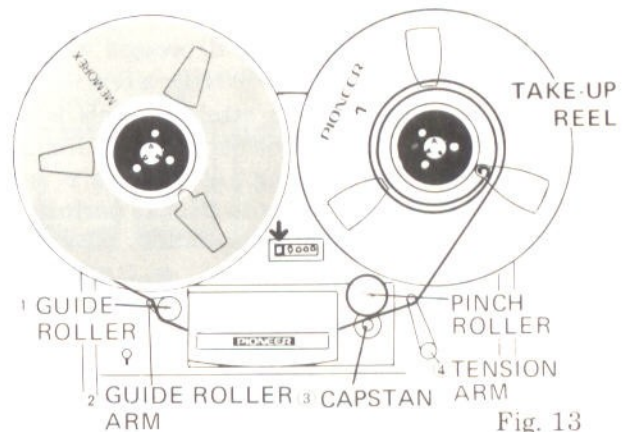

Fig. 13

• Above numbers indicate tape threading Sequence.

### TAPE TRAVEL (Fig. 14)

1. First, confirm that all function buttons are in neutral position. Otherwise, push the ■ STOP button once.
2. Push the POWER switch. The LEVEL meters will light up and the capstan will begin to rotate.
3. Push the ► PLAY button. The tape now travels from left to right.
4. Push the ■ STOP button. The tape stops.

### TAPE SPEED SELECTION (Fig. 15)

As long as the SPEED selector is released, the speed remains set at HI. For LO speed, push the selector. To release it again, push it once more.

- RT-1020L HI: 19cm/s (7-½ ips)  
 LO: 9.5cm/s (3-¾ ips)  
 RT-1020H HI: 38cm/s (15 ips)  
 LO: 19cm/s (7-½ ips)

### THE PAUSE SWITCH (Fig. 16)

The tape traveling at normal speed can be stopped by setting the PAUSE switch at ON. Return it to OFF, and the tape will resume travel. Note, however, that the PAUSE switch does not function during fast forward or fast rewind.

### FAST FORWARD, REWIND (Fig. 17)

1. For fast winding from the left to the right, push the ► FAST FORWARD button. For fast rewinding, push the ◀ REWIND button.
2. To stop the tape, push the ■ STOP button.
3. If the tape runs out or breaks, it will stop automatically.

By employing the PAUSE switch, tape motion can be immediately changed from FAST FORWARD or REWIND to PLAY (see Fig. 18).

When the PLAY button is depressed while the tape is in FAST FORWARD or REWIND, a few seconds will elapse before normal speed is attained. This is to protect the tape. In situations such as looking for the start of a recorded passage, cueing, etc., where it is desired to set the machine immediately to PLAY, perform the following steps.

1. Set the tape motion to ► FAST FORWARD or ◀ REWIND.
2. Depress the ► PLAY button.
3. After the tape has come to a complete stop, operate the PAUSE switch ON-OFF. By doing this, the tape will begin to move at normal speed.

It is important to wait until the tape has stopped completely before operating the PAUSE switch to avoid possible damage to the tape or mechanism.

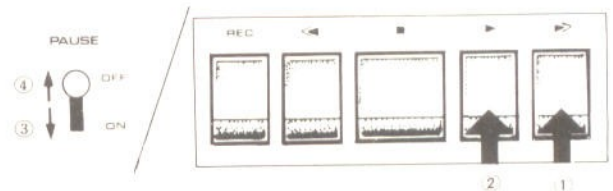
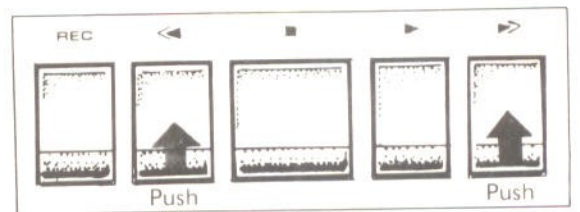
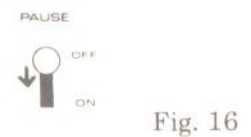
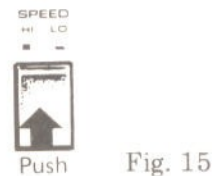
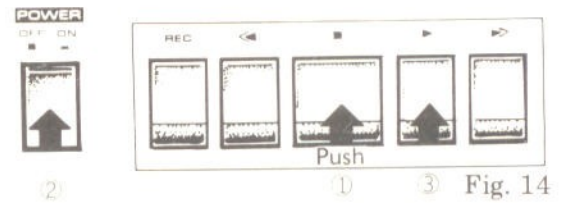

Above numbers indicate operating sequence.

# PLAYBACK

## TAPE THREADING

Thread the tape to be played on the tape deck, as explained on page 9. Be sure to use two reels of the same size and to secure the reels with the reel clampers.

## PLAYBACK PROCEDURE

1. Push the POWER switch to turn the unit on. (Fig. 19). The level meters light up and the capstan begins to rotate. Note, however, that the tape must be taut—with slack tape, the capstan will not rotate.
2. Confirm that the REEL SIZE switch is properly set (Fig. 19). When using 7-inch or smaller reels, push the REEL SIZE switch in. For 10-inch reels, do not push it in. To release this switch when it's locked, push it once again.

Make it a habit to check the REEL SIZE switch position whenever you operate the unit. Wrong reel size setting can cause malfunctions in the tape transport; too tight winding of the tape and, if the condition is permitted to persist, even damage to your tapes.

3. Set the TAPE SPEED selector to the speed at which the tape was recorded (Fig. 19).

RT-1020L HI: 19cm/s (7-1/2 ips)

LO: 9.5cm/s (3-3/4 ips)

RT-1020H HI: 38cm/s (15 ips)

LO: 9.5cm/s (7-1/2 ips)

4. Set the PLAY switch to 4-channel or 2-channel operation (Fig. 20). If the tape contains a 4-channel recording, set the switch at 4CH; if it contains a 2-channel stereo recording, at 2CH. If a 2-channel recorded tape is played over a 4-channel amplifier/speaker system with the PLAY switch set at 4CH, the reverse side of the tape (i.e. the other two tracks) will be heard in reverse from the rear speakers.
5. Set the METERS switch at FRONT (Fig. 20). In position REAR, the LEVEL meters indicate the signal level of the rear channels.
6. Set both MONITOR switches at position TAPE/PLAY. Playback of the signal from recorded tape is not possible if these switches are at SOURCE. See Fig. 20.
7. Push the ► PLAY button (Fig. 21). The tape begins to travel from left to right.
8. Control the output level of the signal from the recorded tape by rotating the OUTPUT LEVEL CONTROL (Fig. 22), with care taken not to make the needles of the LEVEL METERS swing over 0dB. If the input level of the stereo amplifier is low, the sound being played back may be distorted. In such a case, try to make the output level lower by rotating the OUTPUT LEVEL CONTROL to the left

(Continued on the Next Page)

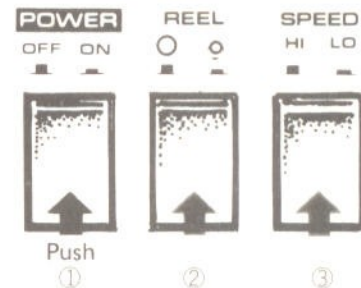

Fig. 19

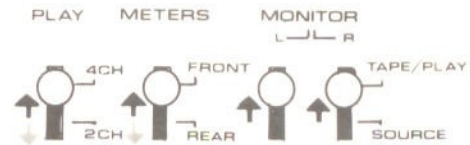

Fig. 20

**NOTE:**  
In 4-channel playback, the METERS switch controls the signals supplied to the LEVEL meters and the headphone jack. Switch position FRONT: Meters indicate signal levels and headphones reproduce front channels (CH. 1 & CH. 3). Switch position REAR: Meters and headphones give rear channel signals (CH. 2 and CH. 4).

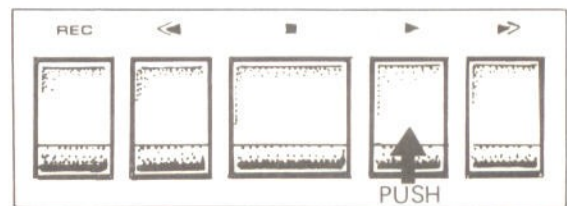
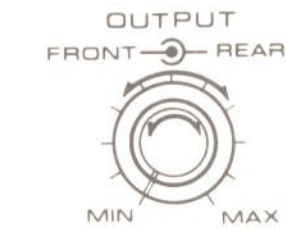

Fig. 21



OUTPUT LEVEL CONTROL Fig. 22

(counterclockwise). If the output levels of other stereo components such as a stereo tuner, turntables, etc. are also low, in the same manner, try to make those levels match the same as the RT-1020L/H's by controlling the OUTPUT LEVEL CONTROL of this tape deck.

9. Set all controls on your 4-channel or 2-channel amplifier for tape playback. Volume and tone must be adjusted with the controls on the amplifier.
10. To interrupt playback momentarily, set the PAUSE switch to position ON (Fig. 23).
11. To stop playback, push the ■ STOP button (Fig. 23). When the tape runs out, however, the unit will be stopped automatically by the auto-stop switch which is linked to the tension arm.

### FAST FORWARD

1. Push the ► FAST FORWARD button (Fig. 24). The tape will be wound from left to right at fast speed.
  - To switch from fast forward directly to playback, simply push the ► PLAY button. The tape will stop for a few seconds and then resume travel at rated speed.
  - If you have fast-forwarded the tape too far, simply push the ◀ REWIND button. The tape will be stopped and then rewound.
2. To stop the tape in fast forward mode, push the ■ STOP button.

### REWINDING

1. Push the ◀ REWIND button. The tape will be rewound from right to left at fast speed. See Fig. 25.
  - To switch from rewind mode to playback, simply push the ► PLAY button. No need to push the ■ STOP button.
  - If you have rewound the tape too far, simply push the ► FAST FORWARD button.
2. To stop the tape in fast rewind mode, push the ■ STOP button. When the tape runs out, the unit will stop automatically.

#### NOTE:

The advanced design of model RT-1020L/H permits it to be switched directly from any operation mode to any other operation mode (for example from fast forward to playback). To save time, it is designed to be unnecessary to push the STOP button between different modes of transport.

Of a variety of magnetic tapes available on the market, thin tape in thickness, used for long hours of continuous playing, must be taken of care not to change the PLAY or STOP mode directly from the FAST-FORWARD mode, for example.

Push the PLAY or STOP button only when reel rotation becomes slow shortly after switching the REWIND mode from the FAST-FORWARD mode or vice versa.

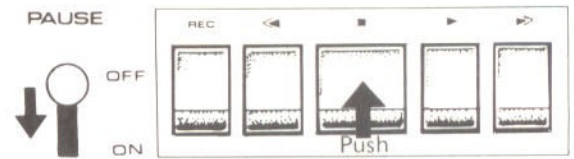

Fig. 23

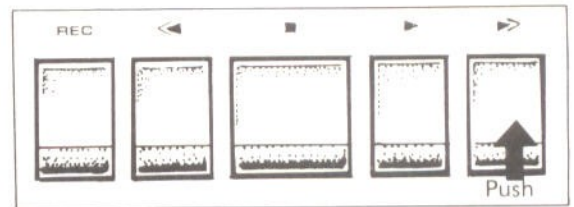

Fig. 24

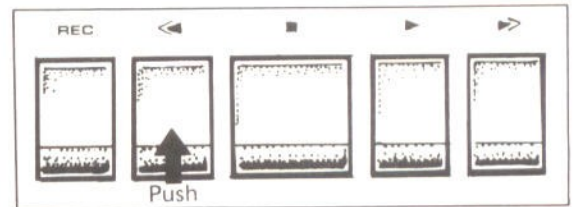

Fig. 25

With the help of an optional timer (available at electrical appliances stores), you can use your tape deck to lullaby you to sleep or to wake you up with music (refer to page 19).

# RECORDING

1. Thread the tape as described on page 9.
2. Push the POWER switch to turn the unit on (Fig. 26).
3. Confirm that the REEL SIZE switch is set correctly. When using 7-inch or smaller reels, push the switch down. For 10-inch reels, do not push it down. When locked, the switch can be released by pushing it once again. Always confirm that the REEL SIZE switch is in the correct position. Wrong setting can impair the tape transport or cause the tape to be wound too tightly or even damaged. Refer to Fig. 26.
4. With the TAPE SPEED selector select the desired tape speed (Fig. 26).  
 RT-1020L HI: 19cm/s (7-1/2 ips)  
 LO: 9.5cm/s (3-3/4 ips)  
 RT-1020H HI: 38cm/s (15 ips)  
 LO: 19cm/s (7-1/2 ips)  
 38cm/s and 19cm/s are most suitable for recording music. 9.5cm/s, suitable for recording conversation, gives longer recording time and greater tape economy, albeit at a slight loss in sound quality.
5. Set the REC BIAS and REC EQ switches in accordance with the type of tape to be used. Refer to Fig. 27. A great variety of normal and "low noise high output" (LH) tapes are now on the market. For details, refer to paragraph "The REC BIAS and REC EQ switches" on the next page.
6. Set both REC switches (L and R) to position ON (Fig. 28).
7. Set the PLAY switch at position 2CH (Fig. 28).
8. Set the METERS switch at position FRONT (Fig. 28).
9. Set both MONITOR switches at position SOURCE. The level meters now indicate the level of the incoming signal so that you can adjust the LINE recording level control for optimum recording quality. If the deck is connected to the amplifier via its DIN-type REC/PB connector, the recording level must be adjusted with the MIC recording level control. Refer to Fig. 29. For details, refer to paragraph "Proper Recording Level Adjustment" on page 15.
10. Push the REC and ► PLAY buttons simultaneously (Fig. 30). The recording indicators light up, the tape begins to travel, and recording starts.
11. To ascertain the quality of the recording being made, set the MONITOR switches at position TAPE/PLAY (Fig. 31). You now hear the taped sound, as picked up by the playback head, through headphones or speakers. If this check reveals poor sound quality, check the possible sources of trouble such as recording level adjustment, wrong REC BIAS or

(Continued on the Next Page)

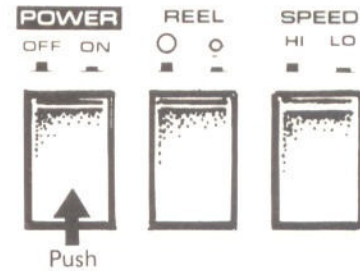

Fig. 26

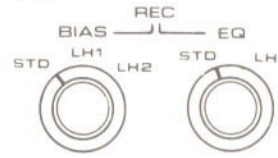

Fig. 27

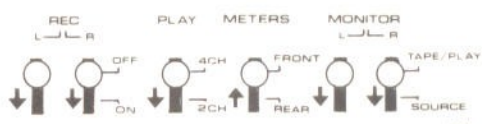

Fig. 28

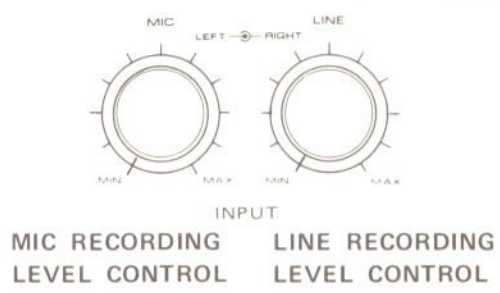

Fig. 29

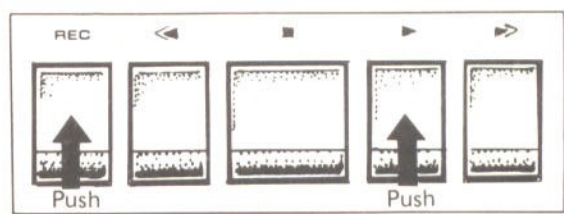

Fig. 30



Fig. 31

REC EQ setting, dirty tape heads, inferior tape quality, etc., and start anew.

12. To interrupt the recording momentarily, set the PAUSE switch at ON. See Fig. 32.
13. Whenever you want to stop the recording, push the ■ STOP button (Fig. 33).

### THE REC BIAS AND REC EQ SWITCHES (Fig. 34)

#### The REC BIAS Switch

A proper amount of bias current must be applied to the tape in order to obtain proper frequency response and distortion-free recordings. This bias current varies with the type of tape to be used.

Actually, almost all brands of tapes not otherwise marked can be considered "normal" and recorded with the REC BIAS switch set at STD. So-called "low-noise high-output" tapes, on the other hand, require more bias current — the REC BIAS switch should be set at LH 1 or LH 2.

- If a recording is made on low-noise high-output tape with the REC BIAS switch at STD, insufficient bias current will cause an unnatural boost in the high sound range, leading to distortions.
- Conversely, a recording made on normal tape with the switch at LH 1 or LH 2 will suffer from poor high frequency response.

#### The REC EQ Switch

The amount of high frequency boost that must be applied to the signal in the recording process differs for normal and low-noise high-output tapes and must be selected along with the bias current. This is done by the REC EQ (recording equalization) switch, set it at STD for normal tapes, at LH for low-noise high-output tapes.

- Recording on LH tape with the switch at STD will cause an unnatural boost in the high range.
- Conversely, recording on normal tape with the switch at LH will cause inferior response in the high frequency range.

#### Switch Settings for Common Brands of Tape

The right-side table gives recommended bias and equalization switch settings for a number of common brands of tape. These settings have been found optimum in actual recording tests with model RT-1020L/H and therefore are not necessarily identical with the tape manufacturers' specifications.

If you want your favorite tone quality, select BIAS and EQ switch setting by switching TAPE MONITOR.

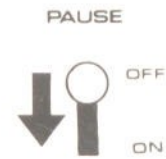

Fig. 32

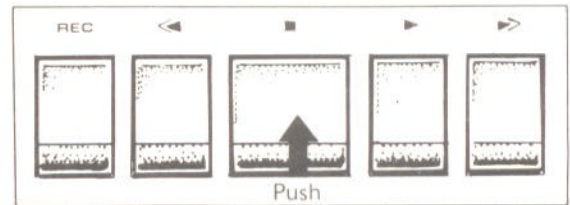

Fig. 33

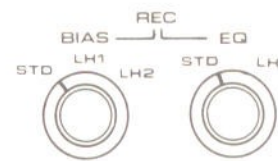

Fig. 34

EQ \ BIAS	STD	LH
STD	100, 150, other normal tape	Some long-playing tapes give good results at this setting.
LH 1	Some long-playing (150) tapes	SCOTCH 203, 206 SONY SLH BASF 35LH MEMOREX
LH 2	SCOTCH 203, 206 (Causes lower recording level but gives correct freq. response.	TDK SD MAXELL LNE AGFA PE36 HITACHI UO D

Table 1

**PROPER RECORDING LEVEL ADJUSTMENT**

When the unit is in recording mode and the METERS switch at FRONT position, the LEVEL meters indicate the recording level. Adjust the LINE or MIC recording level controls in such a way that the meters deflect as far as 0dB at peak volume. Refer to Figs. 35. and 36. If the meters are allowed to peak out — i.e. hit the end of the scale at +3dB — the recording will sound distorted.

**Use of the PAUSE Switch for Level Adjustment**

Put the unit in recording mode and set the PAUSE switch at ON. The tape don't run, but you can adjust the recording level. Then, to start recording, return the PAUSE switch to OFF. The PAUSE switch is also practical for avoiding the recording of announcements and commercials in FM programs.

**Monitoring of a Recording in Progress (Fig. 37)**

Model RT-1020L/H is a three-head tape deck with independent erase, recording and playback head. The erase head automatically erases any previous recording on the tape so that tapes can be used over and over again. The recording head "inscribes" the signal on the tape, while the playback head retrieves it. In a method called "tape monitoring," it is thus possible to hear the playback signal while the recording is being made, and to compare the original "source" sound with the recorded "tape" sound. This is done by alternately setting the MONITOR switches (there is one for each channel) at SOURCE and at TAPE/PLAY. In this way you can ascertain the recording quality and take corrective action if required.

**NOTE:**

While monitoring recording now in progress by switching the stereo amplifier's MONITOR switch ON/OFF (or TAPE/SOURCE), you may sometimes feel sound volume differ when comparing the volume at ON (or TAPE) with the volume at OFF (or SOURCE). In this case, control the OUTPUT LEVEL CONTROL of the RT-1020L/H to adjust the volume at ON to that at OFF.

**FOLLOW-UP RECORDING**

This is a convenient method for re-recording certain portions of an already recorded tape.

1. Set the unit in playback mode by pushing the ► PLAY button. Set the REC switches at position ON (Fig. 38). Listen to the tape as in usual playback.
2. At the point from which you want to re-record, push down the REC and ►PLAY buttons simultaneously (Fig. 39). The unit will switch to recording mode without the tape being stopped. You must push down both the REC and ► PLAY buttons simultaneously. Pushing the REC button alone will stop the tape.

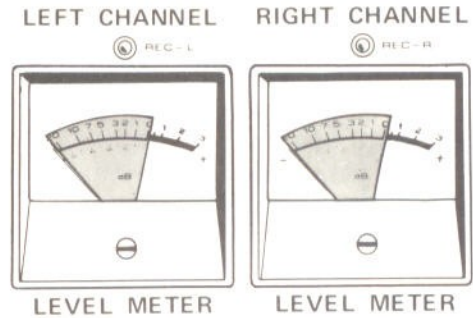

Fig. 35

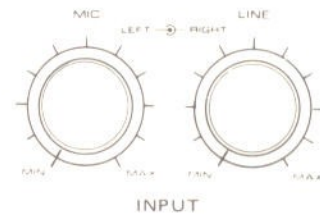

Fig. 36

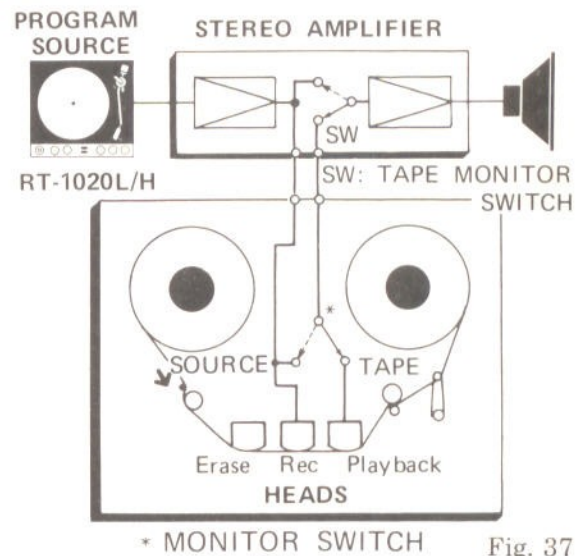

Fig. 37

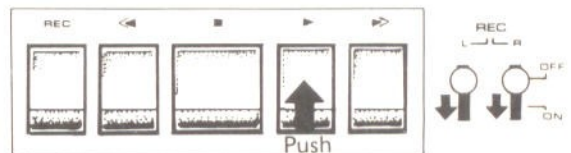

Fig. 38

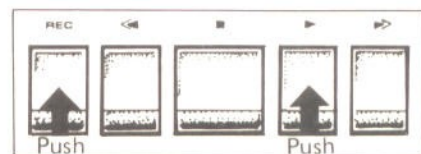

Fig. 39

# LIVE RECORDING WITH MICROPHONES

1. For stereophonic recordings, use two identical microphones and connect them to the MIC input jacks (Fig. 40).
2. Set the REEL SIZE switch and TAPE SPEED selector in accordance with the reel size used and the desired tape speed (Fig. 41).
3. Set both REC switches at ON. Set the PLAY switch at position 2CH (Fig. 42).
4. METERS switch: position FRONT. Both MONITOR switches: position SOURCE.
5. Adjust the recording level with the MIC level controls (Fig. 43).
6. Push down the REC and ► PLAY buttons at the same time (Fig. 44). Recording begins. For monitoring live recordings, we recommend the use of headphones rather than loudspeakers.

**NOTE:**

600-ohm low-impedance as well as 10 – 50k-ohm high-impedance microphones may be used with equally good results. High quality microphones are available from Pioneer.



Fig. 40



Fig. 41

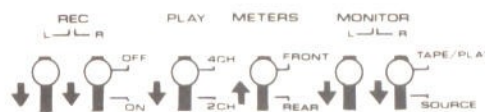

Fig. 42

## 4-TRACK MONOPHONIC RECORDING

By using only one microphone or one channel (L CH. or R CH.) REC terminals, the four tracks of the tape can be used for four separate monophonic recordings (Fig. 45). This method gives greatest tape economy.

1. Make 1st recording on track 1.  
REC switches: L ON, R OFF. Use LEFT channel MIC jack or INPUT (REC) terminal (Fig. 46).
2. Turn tape over, re-load. Make 2nd recording on track 4. Controls and inputs as before.
3. Turn tape over again. Make 3rd recording on track 3.  
REC switches: L OFF, R ON. Use RIGHT channel MIC jack or INPUT (REC) terminal (Fig. 47).
4. Turn tape over again. Make 4th recording on track 2. Controls and inputs as above.

The tape now contains four monophonic recordings on tracks 1, 4, 3 and 2, in that order.

**NOTE:**

For playing back the monophonic tape recorded in the order of tracks 1, 4 (L channels) and 2, 3 (R channels), use the following procedure:

1. Set the PLAY switch of model RT-1020LH to position 2CH.
2. For playback of tracks 1, 4: set the amplifier's MODE switch to position MONO LEFT.
3. For playback of tracks 2, 3: set the MODE switch to position MONO RIGHT.

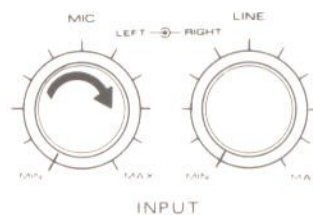

Fig. 43

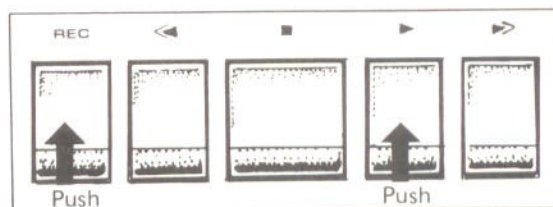

Fig. 44

Track 1	L <sub>1</sub>	(1) Input to left channel, tape side 1
Track 2	R <sub>2</sub>	(4) Input to right channel, tape side 2
Track 3	R <sub>1</sub>	(3) Input to right channel, tape side 1
Track 4	L <sub>2</sub>	(2) Input to left channel, tape side 2

(1) – (4) is the recommended order of making four monophonic recordings.

Fig. 45



Fig. 46

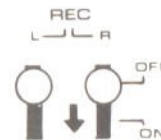

Fig. 47

## WHEN EMPLOYING DIGITAL TIMER

By using a separately sold digital timer, or time switch, unattended recording, programmed start and stop operation, such as when using BGM at a store can be performed.

### UNATTENDED RECORDING

1. Connect the power cords of the RT-1020L/H, amplifier, tuner, etc. to digital timer (see Fig. 52).
2. Turn on the power switches of the RT-1020L/H, amplifier and tuner.
3. Operate amplifier and tuner, select station to be recorded, and adjust RT-1020L/H recording levels.
4. Set digital timer so that power will be supplied to the equipment at the desired time. Since power will be interrupted while the timer is being set, the operating buttons of the RT-1020L/H will be released. Therefore, again simultaneously depress the REC and ► PLAY buttons. By this setup, when the desired time arrives, power will automatically be supplied to the equipment and recording will start.

If the timer is set so that the power will again be cut after the desired interval has elapsed, unattended recording can be confidently performed.

### SLEEP AND WAKEUP OPERATION

1. Connect the power cords of the RT-1020L/H, amplifier, tuner etc. to digital timer.
2. By setting the timer so that power will be cut off after 30 to 60 minutes, the listener can fall asleep to music and let the timer automatically turn off the equipment (sleep operation).
3. For wakeup operation, set the timer so that power will be supplied to the equipment at the desired time and operate the RT-1020L/H according to the "PLAYBACK" section on page 11. If the POWER switch is then set to ON, playback will automatically start at the desired time (wakeup operation).

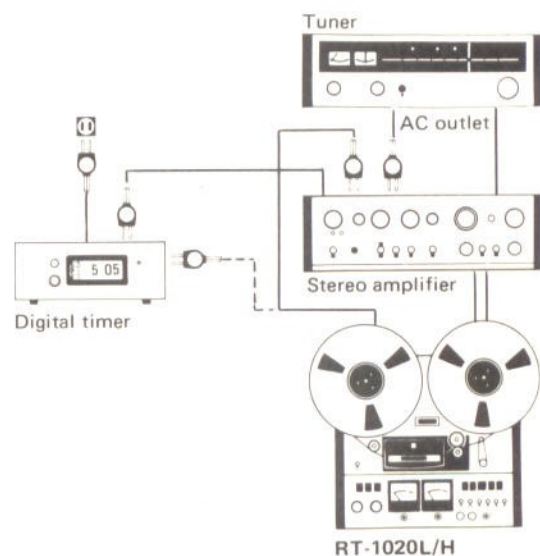

Fig. 52

Input signals supplied to the MIC and INPUT (REC) terminals, or to the REC/PB connector and INPUT (REC) terminals can be mixed on a recording.

**Microphone Signal + INPUT (REC) Signal**

1. Connect microphones to MIC jacks, supply signal from stereo amplifier to INPUT (REC) terminals (Fig. 48).
2. Adjust MIC and LINE recording level controls to obtain proper balance and total recording level.
3. Make recording as described on page 13.

**REC/PB Signal + INPUT (REC) Signal**

1. Connect two signal sources to REC/PB connector and INPUT (REC) terminals.
2. Adjust level of REC/PB signal with MIC recording level controls. Adjust level of INPUT (REC) signal with LINE recording level controls.
3. Make recording as described on page 13.

**SOUND-ON-SOUND RECORDING**

Sound-on-sound is a method in which two (or more) consecutive monophonic recordings can be mixed onto one tape track. Common applications of this technique include dual or triple recordings of a singer to obtain a chorus effect, or consecutive recordings of various instruments adding up to the sound of a band. The process is quite simple — the first recording is made on one tape track as usual. Then, the tape is rewound to the start. The second recording is made on the other tape track while the first recording is monitored and copied onto the other track. This process can be repeated several times, but each time the total mix of all previous recordings must be transferred to the other tape track. Refer to Fig. 49. Step-by-step procedure is as follows:

**FIRST RECORDING ALREADY MADE ON LEFT CHANNEL**

1. Connect FRONT LEFT OUTPUT (MON) terminal to RIGHT INPUT REC terminal (Fig. 50). Connect microphone to RIGHT MIC input jack.
2. Set REC switch L at OFF, REC switch R at ON.
3. Adjust recording levels with MIC and LINE recording level controls to obtain proper sound balance.
4. Table 2 shows the influence of the MONITOR switches upon LEVEL meter indication and output signals in sound-on-sound recording mode.
4. Make recording, then rewind tape and confirm recording quality. If unsatisfactory, repeat procedure. The original recording is still there on the left channel.

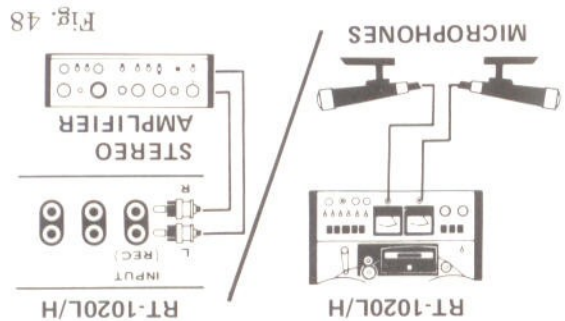
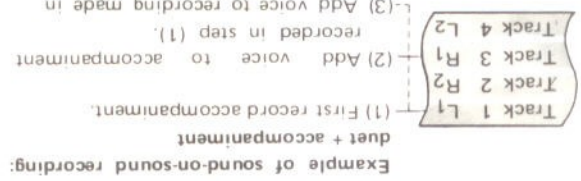

Fig. 48

**NOTE:**  
In MIC + LINE mixing, it is advisable to use a somewhat lower LINE recording level than in single-source recordings.



Example of sound-on-sound recording:  
duet + accompaniment  
(1) First record accompaniment.  
(2) Add voice to accompaniment recorded in step (1).  
(3) Add voice to recording made in step (2).  
Follow steps (1), (2), (3) in that order.

Fig. 49

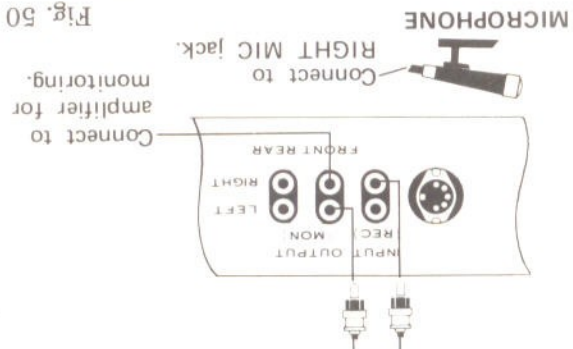

Fig. 50

MONITOR SWITCHES	CHANNELS	LEVEL METERS	SIGNAL AT OUTPUT JACKS
TAPES/PLAY	LEFT	INDICATES ORIGINAL RECORDING	ORIGINAL RECORDING
	RIGHT	INDICATES RECORDING JUST MADE	RECORDING JUST MADE
SOURCE	LEFT		
	RIGHT	INDICATES SIGNAL NOW BEING RECORDED	RECORDED

Table 2

**PLAYBACK OF RIGHT CHANNEL, RECORDING ON LEFT CHANNEL**

1. Connect FRONT RIGHT OUTPUT (MON) terminal to LEFT INPUT (REC) terminal. Connect microphone to LEFT MIC jack.
2. Set REC button L at ON, REC button R at OFF.

**ECHO RECORDING**

Interesting ambience effects can be obtained by employing echo recording for live material (especially vocal).

**CONNECTING METHOD**

1. Connect microphones to MIC jacks.
2. Connect connecting cords from LEFT & RIGHT OUTPUT (MON) terminals to the LEFT & RIGHT INPUT (REC) terminals and stereo amplifier LEFT & RIGHT playback (TAPE MONITOR) terminals (see Fig. 51).

**LEFT OUTPUT**



**RIGHT OUTPUT**



**RECORDING & PLAYBACK PROCEDURE**

1. Set LINE recording level control to MIN (minimum).
2. Position MONITOR switch to SOURCE and adjust MIC recording level for optimum level meter deflection.
3. With the LINE recording level control at MIN, set the MONITOR switch to TAPE/PLAY and begin recording.
4. Set the stereo amplifier monitor switch to ON. While slowly turning the LINE recording level control, listen to echo condition. Stop rotating at the best position.

**NOTE:**

1. If the LINE recording level control is increased excessively, howling will be produced. Therefore use caution.
2. Echo condition effects differ at different tape speeds. Change the TAPE SPEED selector setting to determine the most desirable effect.

RT-1020L/H

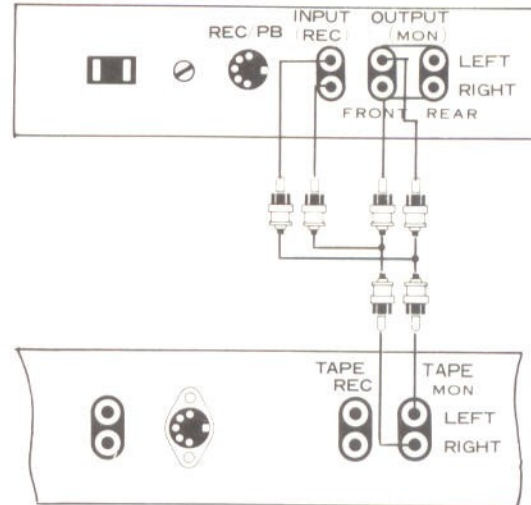

Input terminals of 2 ch. stereo amplifier

**NOTE:**

For echo recording, you need special connecting cords like those which are shown in the Figure. For details, consult your audio dealer.

Fig. 51

## CARE & MAINTENANCE

Model RT-1020L/H is a sophisticated precision instrument. Careful treatment and meticulous maintenance will pay off in superb performance time after time.

### CLEANING OF HEADS AND TAPE PATH

The parts shown in Fig. 55 — tape guide, heads, pinch roller, capstan and tension arm — easily become dirty. They should be kept scrupulously clean because dirt or oil on these parts can cause inferior sound quality and stereo balance, unstable tape transport and other troubles. At the first sign of dirt, clean these parts with the supplied cleaning ribbon as shown in Fig. 56. Before using the ribbon, push down the pinch roller in the arrow-indicated direction and pull at both ends of the ribbon by hand to bring it into direct contact with the capstans. Then try cleaning. Stubborn dirt and deposits can be removed with the supplied cleaning bar or a piece of cloth moistened with the supplied cleaning fluid.

### HEAD DEMAGNETIZING

As some static magnetism builds up in the tape heads after long-term use, these should be demagnetized with a demagnetizer about once a month. Refer to Fig. 57 and observe the instructions supplied with the demagnetizer.

### LUBRICATION

Model RT-1020L/H uses oilless metal in most of its moving parts. Only the following three parts should be lubricated with top quality machine oil once a year (Fig. 58).

Flywheel bearing	1 - 2 drops	} After lubrication, carefully wipe off excess oil.
Pinch roller shaft	1 drop	

Be especially careful not to put any oil on the capstan and rubber pinch roller. If this should happen, clean the capstan and pinch roller thoroughly with the supplied cleaning fluid.

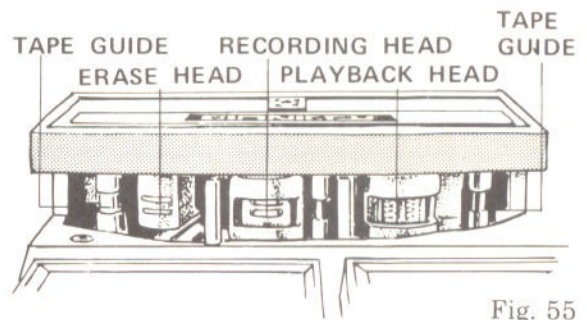
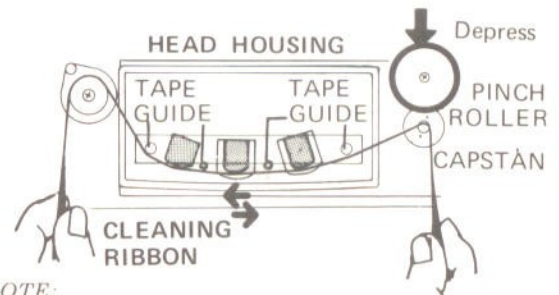

Fig. 55



NOTE:  
Hold cleaning ribbon taut, depress pinch roller downwards; ribbon will then contact heads.

Fig. 56

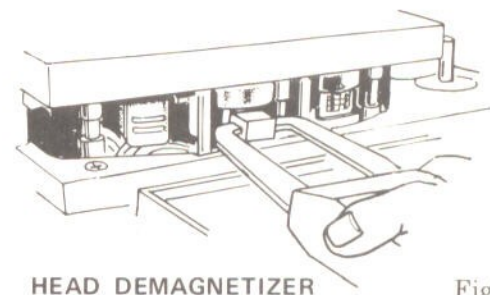

Fig. 57

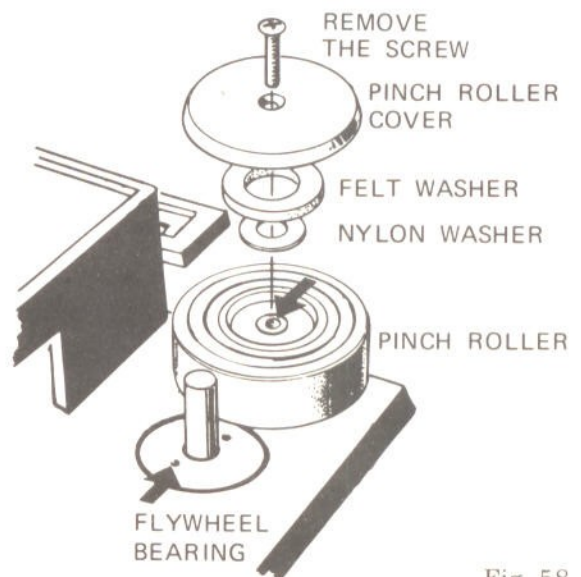

Fig. 58

# KEYS TO SUCCESSFUL RECORDING TECHNIQUE

The quality of a live recording with the use of microphones is determined not only by tape deck performance, but is also greatly influenced by microphone characteristics and arrangement. At the same time, skillful handling of such accessory equipment as microphone stands, mixing devices etc. is important for obtaining optimum benefit from the microphones, and consequently a better recording.

## Microphone Characteristics

Microphones are specified in terms of sensitivity, frequency response, impedance, and directionality. Microphones with a sensitivity of  $(-72 \text{ dB}/\mu\text{Bar} \sim -58 \text{ dB}/\mu\text{Bar})$  and an impedance between  $600\Omega$  and  $50k\Omega$  are acceptable for use with the RT-1020L/H. However, if long extensions are employed,  $600\Omega$  is recommended.

While a wide frequency response microphone is desirable, width is not the only determining factor. Excessive peaking in the frequency response graph should also be absent, in order to avoid unnatural emphasis in the recorded sound.

In terms of directionality, microphones can be broadly classified into unidirectional and nondirectional types, with the most versatile being those containing a switch for selection of either type. For stereo recordings, a not too sharp unidirectional microphone tends to be easier to use. Nondirectional microphones have a drawback in that they are apt to pick up background noise. On the other hand, they have the feature of being able to combine reverberations with the sound, making them easier for obtaining a more lifelike recording.

## Stereo Recording Basics

Figs 1, 2 & 3 show typical basic arrangements using left and right unidirectional microphones. The arrangement in Fig. 1 is referred to as a one-point system and if microphone distance is carefully selected according to the sound source width, comparatively good quality recordings can be obtained.

While the Fig. 2 arrangement provides good sound positioning, the stereo effect can be lost if microphone directionality is too sharp. With the Fig. 3-A method, excessive microphone separation can cause weak center sound upon speaker reproduction, resulting in a disturbing "hole in the middle" effect. This can be avoided by keeping the distance between microphones within 3 meters (about 10 ft.) or by employing a center microphone as shown in Fig. 3-B.

## Multiple Microphone Method

This is a mixing method which utilizes a separate microphone for each instrument with each level adjusted by a mixer. It is effective when the volume difference between individual instruments is large or when lively direct instrument sound is desired.

Certain technical sophistication is needed for some points of mixing amplifier operation. Ideally, a completely soundproof monitoring room should be employed for obtaining sound balance. If the opportunity of using such a monitoring room is unavailable, headphones can be employed to individually monitor the sound pickup of each microphone. After setting each level, the resulting sound is then mixed.

Careful attention must be paid to overlapping sounds from instruments other than the one to which the microphone is pointed. If such overlapping is excessive, sound clarity can be easily deteriorated.

If a mixer equipped with PAN-POT (panoramic potentiometers) is available, which can electrically move left and right microphones, auxiliary stereo microphones can be set up at a slight distance from the subject, as shown in Fig. 4. Overall sound balance can then be effectively obtained by adjusting the PAN-POT.

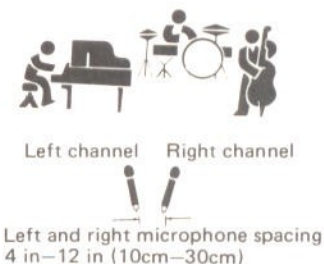

Fig. 1



Fig. 2

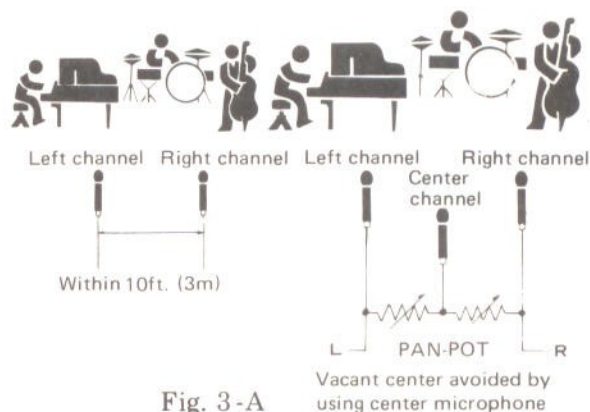

Fig. 3-A

Fig. 3-B

Mic: Auxiliary stereo microphones  
 Each microphone level control

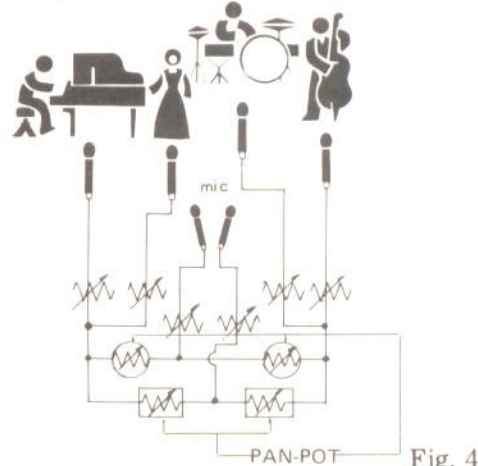

Fig. 4

## TROUBLE-SHOOTING CHART

What appears to be a defect or malfunction of the machine is often caused by operating errors, inferior tape quality or poor maintenance. The following chart lists common malfunctions and the ways to avoid them.

TROUBLE	CAUSE	REMEDY
1. No power	AC cord not properly plugged in	Check connection, plugs, sockets.
2. No or unstable tape travel	a) Slack tape b) Two reels of different size. c) REEL SIZE switch not set correctly.	a) Pull tape taut. b) Use two reels of the same size. c) Check position of REEL SIZE switch.
3. Rewinding impossible	Different reel sizes	Use two reels of the same size.
4. Noisy playback sound	a) Connection cords not properly b) Noise contained in recording tape c) External induction noise  d) Heads magnetized	a) Check connections. b) No remedy. Use better tape. c) Place unit and tapes away from TV set, amplifier, fluorescent tubes and other appliances that cause interference. d) Demagnetize heads.
5. Drop-outs	a) Heads dirty  b) Tape dirty c) Tape stretched or curled	a) Clean heads with supplied cleaning bar or fluid. b) } c) } Use tape of higher quality.
6. Poor playback sound quality (poor frequency response, distortion, unwanted recorded sound)	a) Heads dirty  b) Playback at wrong tape speed c) Tape is recorded with different track system.	a) Clean heads with supplied cleaning bar or fluid. b) Operate deck at specified speed. c) Ascertain track system of recording. Set PLAY switch accordingly.
7. 2-channel playback impossible, but level meters indicate.	Stereo amplifier connected to OUTPUT (MON) REAR L, R terminals	Connect to OUTPUT (MON) FRONT L, R terminals
8. Recording impossible. Level meters do not indicate.	Not properly connected	Check connection to INPUT (REC) terminals of MIC jacks.
9. Distortions in self-made recording	Recording was made with excessive input level.	Turn output level controls on tuner or amplifier down to obtain correct recording level when level controls on tape deck are in center position.

**PIONEER ELECTRONIC CORPORATION**

4-1, Meguro 1-Chome, Meguro-ku, Tokyo 153, Japan

**U.S. PIONEER ELECTRONICS CORPORATION**

75 Oxford Drive, Moonachie, New Jersey 07074, U.S.A.

**PIONEER ELECTRONIC (EUROPE) N.V.**

Luithagensteenweg no. 9, 2030 Antwerp, Belgium

**PIONEER ELECTRONICS AUSTRALIA PTY. LTD.**

178-184 Boundary Road, Braeside, Victoria 3195, Australia

<RRB-031-C> Printed in Japan

