

MC352 Power Amplifier

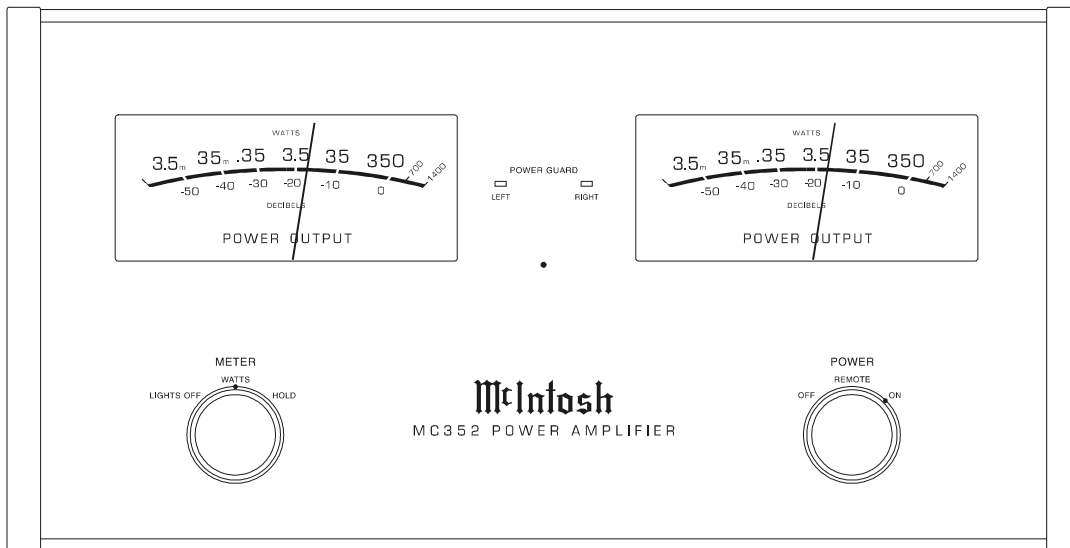

MC352

Thank You

Your decision to own this McIntosh MC352 Power Amplifier ranks you at the very top among discriminating music listeners. You now have "The Best." The McIntosh dedication to "Quality," is assurance that you will receive many years of musical enjoyment from this unit.

Please take a short time to read the information in this manual. We want you to be as familiar as possible with all the features and functions of your new McIntosh.

Please Take A Moment

The serial number, purchase date and McIntosh dealer name are important to you for possible insurance claim or future service. The spaces below have been provided for you to record that information:

Serial Number: _____

Purchase Date: _____

Dealer Name: _____

Technical Assistance

If at any time you have questions about your McIntosh product, contact your McIntosh dealer who is familiar with your McIntosh equipment and any other brands that may be part of your system. If you or your dealer wish additional help concerning a suspected problem, you can receive technical assistance for all McIntosh products at:

McIntosh Sales Corporation
661 W. Redondo Beach Blvd.
Gardena, CA 90247
Phone: 888-979-3737
Fax: 310-217-9288

Customer Service

If it is determined that your McIntosh product is in need of repair, you can return it to your dealer. You can also return it to the McIntosh Laboratory Service Repair department. For assistance on factory repair return procedure, contact the McIntosh Repair Department at:

McIntosh Laboratory, Inc.
2 Chambers Street
Binghamton, New York 13903
Phone: 607-723-3515
Fax: 607-723-1917

Copyright 1998 © by McIntosh Laboratory, Inc.

Table of Contents

Thank You	2
Please Take a Moment	2
Technical Assistance	2
Customer Service	2
Table of Contents	2
Safety Instructions	3
Introduction	4
Performance Features	4
Installation	5
Rear Panel Controls and Connections	6
How to Connect	7
Front Panel Displays and Controls	8
How to Operate	9
Specifications	10
Packing Instruction	11

NOTES:

- The following Connecting Cable is available from the McIntosh Parts Department:
Data and Power Control Cable Part No. 170-202
Six foot, shielded 2 conductor, with 1/8 inch stereo mini phone plugs on each end.*
- For additional connection information, refer to the owner's manual(s) for any component(s) connected to the MC352 Amplifier.*
- There is a built-in turn on delay which will mute the speaker outputs for approximately two seconds when the amplifier is turned on.*
- It is very important that loudspeaker cables of adequate size be used in your music system, to ensure that there will be no power loss or heating. Cable size is specified in Gauge numbers or AWG, (American Wire Gauge). The smaller the Gauge number, the larger the wire size:
If your loudspeaker cables are 25 feet (7.62m) or less, use at least 16 Gauge (AWG) wire size or larger.
If your loudspeaker cables are 50 feet (38.1m) or less, use at least 14 Gauge (AWG) wire size or larger.
If your loudspeaker cables are 100 feet (76.2m) or less, use at least 12 Gauge (AWG) wire size or larger.*
- Pin configuration for the XLR Balanced Input connectors on the MC352: PIN 1: Shield or ground.
PIN 2: + input.
PIN 3: - input.*
- In the event that MC352 Power Amplifier over heats, due to improper ventilation and/or extremely high ambient temperature, the built in protection circuits will activate. The MC352 Front Panel Power Guard LED's will both continuously indicate On and the audio input signal will be muted. When the temperature of the MC352 has returned to a safe condition, sound will return and the Power Guard Indicators will return to normal operation.*

IMPORTANT SAFETY INSTRUCTIONS!

PLEASE READ THEM BEFORE OPERATING THIS EQUIPMENT.



WARNING SHOCK HAZARD - DO NOT OPEN.

The lightning flash with arrowhead, within an equilateral triangle, is intended to alert the user to the presence of uninsulated "dangerous voltage" within the product's enclosure that may be of sufficient magnitude to constitute a risk of electric shock to persons.



AVIS RISQUE DE CHOC - NE PAS OUVRIR.

The exclamation point within an equilateral triangle is intended to alert the user to the presence of important operating and maintenance (servicing) instructions in the literature accompanying the appliance.



NO USER-SERVICEABLE PARTS INSIDE. REFER SERVICING TO



QUALIFIED PERSONNEL

To prevent the risk of electric shock, do not remove cover (or back). No user serviceable parts inside. Refer servicing to qualified personnel.

Attention: pour prevenir les chocs electriques pas utiliser cette fiche polarisee avec un prolongateur, une prise de courant ou un autre sortie de courant, sauf si les lames peuvent etre inserees afond ans en laisser aucune partie a decouvert.

7. For added protection for this product during a lightning storm, or when it is left unattended and unused for long periods of time, unplug it from the wall outlet. This will prevent damage to the product due to lightning or power line surges.
8. Do not use attachments not recommended in this owner's manual as they may cause hazards.

Installation:

9. Locate the equipment for proper ventilation. For example, the equipment should not be placed on a bed, sofa, rug, or similar surface that may block ventilation openings; or, placed in a built-in installation, such as a bookcase or cabinet, that may impede the flow of air through the ventilation openings.
10. Locate the equipment away from heat sources such as radiators, heat registers, stoves, or other appliance (including amplifiers) that produce heat.
11. Mount the equipment in a wall or cabinet only as described in this owner's manual.
12. Do not use this equipment near water; for example, near a bathtub, washbowl, kitchen sink, laundry tub, in a wet basement or near a swimming pool, etc.
13. Do not place this product on an unstable cart, stand, tripod, bracket, or table. The equipment may fall, causing serious injury to a person, and serious damage to the product.

Connection:

14. Connect this equipment only to the type of AC power source as marked on the unit.
15. Route AC power cords so that they are not likely to be walked on or pinched by items placed upon or against them, paying particular attention to cords at plugs, convenience receptacles, and the point where they exit from the instrument.
16. Do not defeat the inherent design features of the polarized plug. Non-polarized line cord adapters will defeat the safety provided by the polarized AC plug. If the plug should fail to fit, contact your electrician to replace your obsolete outlet. Do not defeat the safety purpose of the grounding-type plug.

General:

1. Read all the safety and operating instructions, contained in this owner's manual, before operating this equipment.
2. Retain this owner's manual for future reference about safety and operating instructions.
3. Adhere to all warnings and operating instructions.
4. Follow all operating and use instructions.
5. **Warning: To reduce risk of fire or electrical shock, do not expose this equipment to rain or moisture. This unit is capable of producing high sound pressure levels. Continued exposure to high sound pressure levels can cause permanent hearing impairment or loss. User caution is advised and ear protection is recommended when playing at high volumes.**
6. **Caution: to prevent electrical shock do not use this (polarized) plug with an extension cord, receptacle or other outlet unless the blades can be fully inserted to prevent blade exposure.**

17. Do not overload wall outlets, extension cords or integral convenience receptacles as this can result in a risk of fire or electric shock.

Care of Equipment:

18. Clean the instrument by dusting with a dry cloth. Unplug this equipment from the wall outlet and clean the panel with a cloth moistened with a window cleaner. Do not use liquid cleaners or aerosol cleaners.
19. Do not permit objects of any kind to be pushed and/or fall into the equipment through enclosure openings. Never spill liquids into the equipment through enclosure openings.
20. Unplug the power cord from the AC power outlet when left unused for a long period of time.

Repair of Equipment:

21. Unplug this equipment from the wall outlet and refer servicing to a qualified service personnel under the following conditions:
 - A. The AC power cord or the plug has been damaged.
 - B. Objects have fallen, or liquid has been spilled into the equipment.
 - C. The equipment has been exposed to rain or water.
 - D. The equipment does not operate normally by following the operating instructions contained within this owner's manual. Adjust only those controls that are covered by the operating instructions, as an improper adjustment of other controls may result in damage and will often require extensive work by a qualified technician to restore the product to its normal operation.
 - E. The equipment has been dropped or damaged in any way.
 - F. The equipment exhibits a distinct change in performance - this indicates a need for service.
22. Do not attempt to service beyond that described in the operating instructions. All other service should be referred to qualified service personnel.
23. When replacement parts are required, be sure the service technician has used replacement parts specified by McIntosh or have the same characteristics as the original part. Unauthorized substitutions may result in fire, electric shock, or other hazards.
24. Upon completion of any service or repairs to this product, ask the service technician to perform safety checks to determine that the product is in proper operating condition.

Introduction

Now you can take advantage of traditional McIntosh standards of excellence in the MC352 Power Amplifier. Two 350 watt high current output channels will drive any high quality loudspeaker system to its ultimate performance. The MC352 reproduction is sonically transparent and absolutely accurate. The McIntosh Sound is "The Sound of the Music Itself."

Performance Features

● Power Output

The MC352 consists of two separate power amplifier channels, each capable of 350 watts into 2, 4 or 8 ohm speakers with less than 0.005% distortion.

● Full Balanced Circuitry

The MC352 is fully balanced from inputs to outputs. Each channel consists of two matched power amplifiers operating in push-pull with their outputs combined in a McIntosh Autoformer. The double balanced configuration cancels virtually all distortion.

● Power Guard

Both channels include the patented McIntosh Power Guard circuit that prevents the amplifier from being overdriven into clipping with its harsh distorted sound that can also damage your valuable loudspeakers.

● Sentry Monitor and Thermal Protection

McIntosh Sentry Monitor power output stage protection circuits ensure the MC352 will have a long and trouble free operating life. Built-in thermal protection circuits guard against overheating.

● Patented Autoformers

McIntosh designed and manufactured Output Autoformers provide an ideal match between the amplifier output stages and speaker loads of 2, 4 and 8 ohms. The Autoformers also give perfect DC protection for your valuable loudspeakers.

● Illuminated Power Meters

The illuminated power output watt meters on the MC352 are peak responding, and indicate the true power output of the amplifier. The Peak Hold Mode allows the meters to temporarily stay at the highest power output and then slowly decay.

Installation

The MC352 can be placed upright on a table or shelf, standing on its four feet. It also can be custom installed in a piece of furniture or cabinet of your choice. The required panel cutout, ventilation cutout and unit dimensions are shown.

Always provide adequate ventilation for your MC352. Cool operation ensures the longest possible operating life for any electronic instrument. Do not install the MC352 directly above a heat generating component such as a high powered amplifier. If all the components are installed in a single cabinet, a quiet running ventilation fan can be a definite asset in maintaining all the system components at the coolest possible operating temperature.

A custom cabinet installation should provide the following minimum spacing dimensions for cool operation. Allow at least 6 inches (15.24 cm) above the top, 2 inches (3.81cm) below the bottom and 1 inch (2.54 cm) on each side of the amplifier, so that airflow is not obstructed. Allow 21 inches (53.3 cm) depth behind the mounting panel, which includes clearance for connectors. Allow 1-1/8 inches (2.9 cm) in front of the mounting panel for knob clearance. Be sure to cut out a ventilation hole in the mounting shelf according to the dimensions in the drawing.

NOTE: In Europe, if the MC352 is custom mounted, an additional ventilation opening of 6 inch (15.24 cm) in height, running the full width of the front panel, needs to be directly above the front top of the MC352.

Front View of the MC352 custom installed

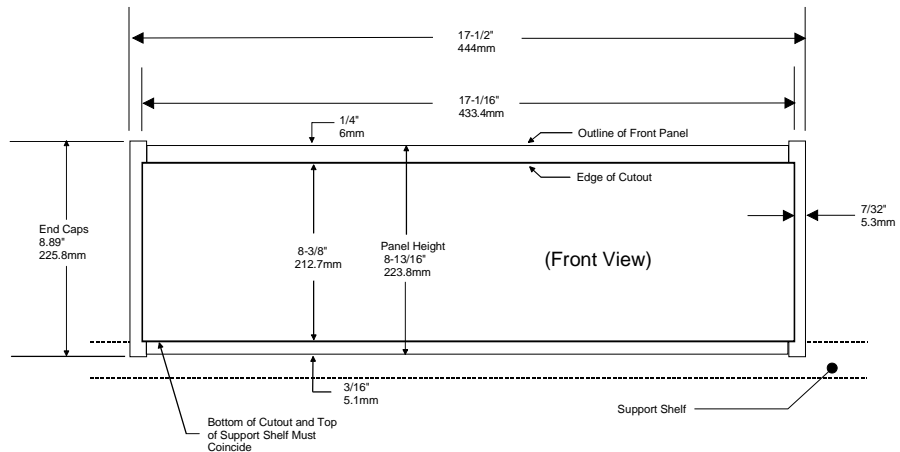

Side View of the MC352 custom installed

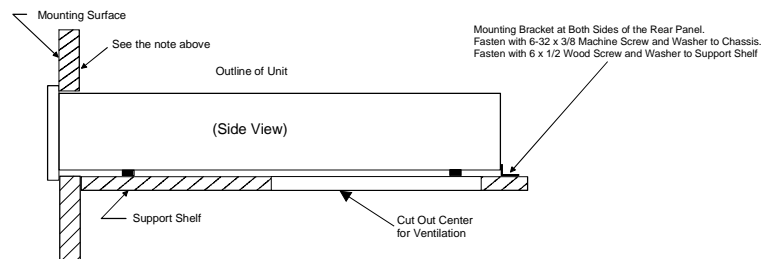

Bottom View of the MC352 custom installed

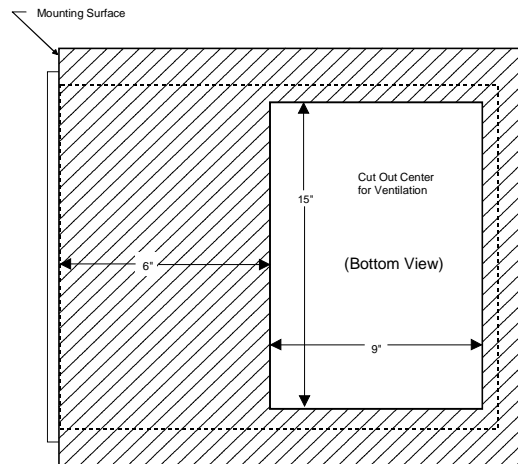

MC352 Rear Panel Controls and Connections

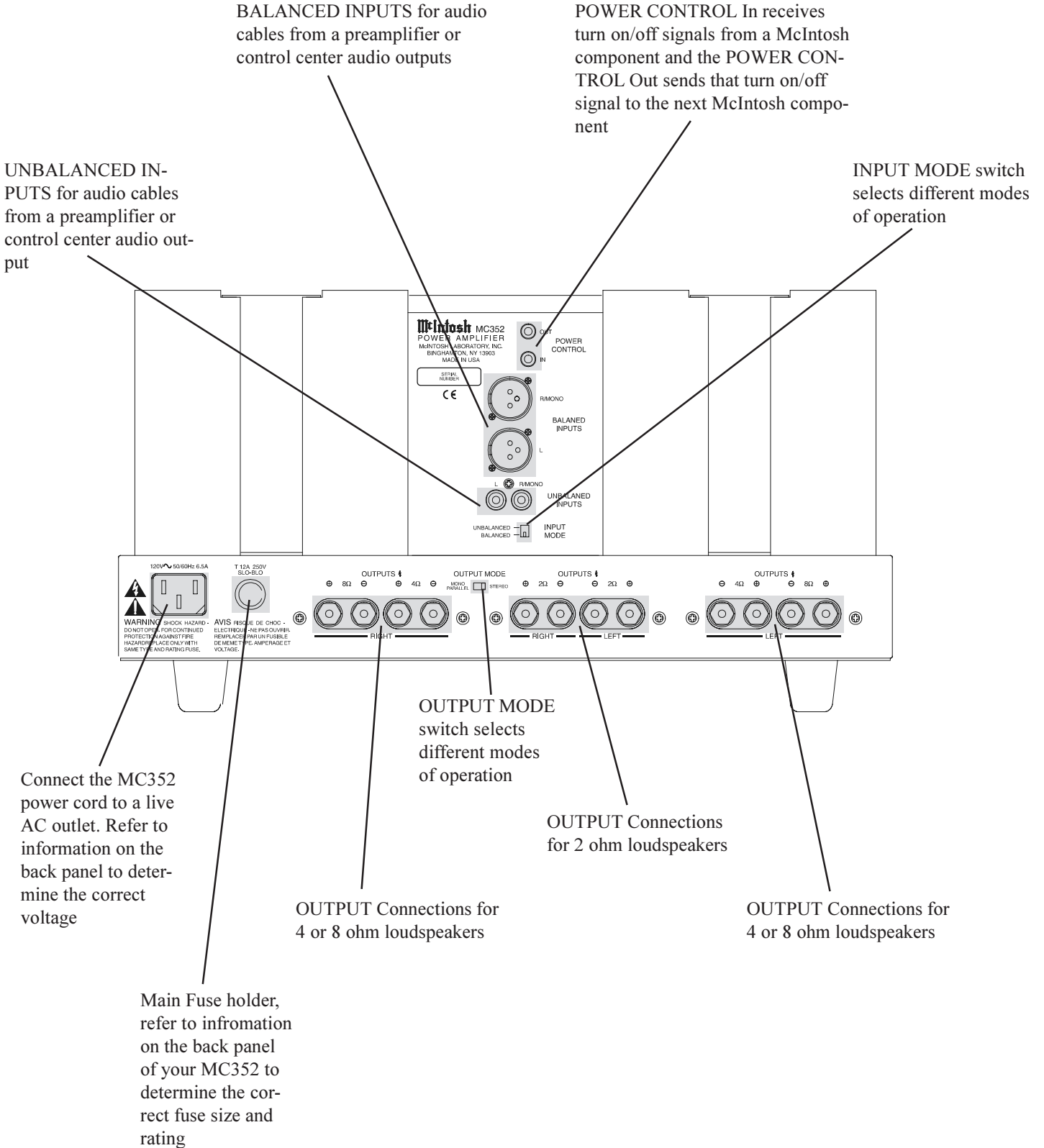

How to Connect the MC352

1. Connect the MC352 power cord to a live AC outlet.
2. Connect a power control cable from the control center Power Control Out to the MC352 Power Control In.
3. Prepare the loudspeaker hookup cables as follows:

A. Carefully remove sufficient insulation from the loudspeaker cable ends to just fit within the binding post with no exposed wire accessible. Refer to figure 1.

B. If the cable is stranded, carefully twist the strands together as tightly as possible. Refer to figures 2 & 3.

Note: If desired, the twisted cable section can be tinned with a solder iron to keep the strands together and/or attach appropriate connector ends.

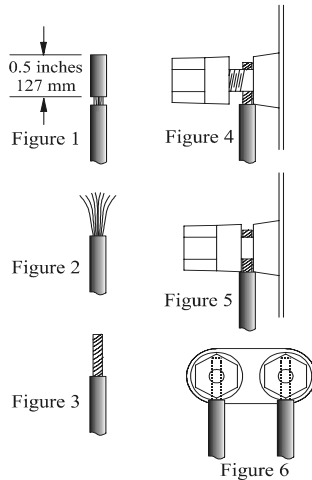

- C. Insert the bare section of the cable end or connector into the access hole, and tighten the terminal nut clockwise until the cable is firmly clamped into the terminal so the wires cannot slip out. Refer to figure 4.
- D. Insert the bare section of the cable end or connector into the access hole, and tighten the terminal nut clockwise until the cable is firmly clamped

into the terminal. Refer to figures 5 & 6.

Note: The bare sections of the cable ends or the non insulated part of the connectors must not be exposed on either side of the terminal access hole.

E. Repeats Steps A through D for each speaker cable used with the amplifier.

4. Connect the loudspeaker cables to the appropriate terminals for your loudspeakers, being careful to observe the correct polarities. Output impedance connections of 2 ohms, 4 ohms and 8 ohms are provided. If the impedance of your loudspeakers is rated at other than the listed impedance connections, use the nearest lower connection.

5. Install the plastic protective loudspeaker terminal covers that were supplied with your amplifier. Refer to figure 7.

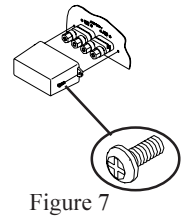

6. Connect a cable from the balanced outputs of a control center to the MC352 balanced Input connectors for both audio channels and power control.

Note: An optional hookup is to use unbalanced cables from a McIntosh Control Center to Unbalanced Inputs of the MC352.

McIntosh C42 Audio Control Center

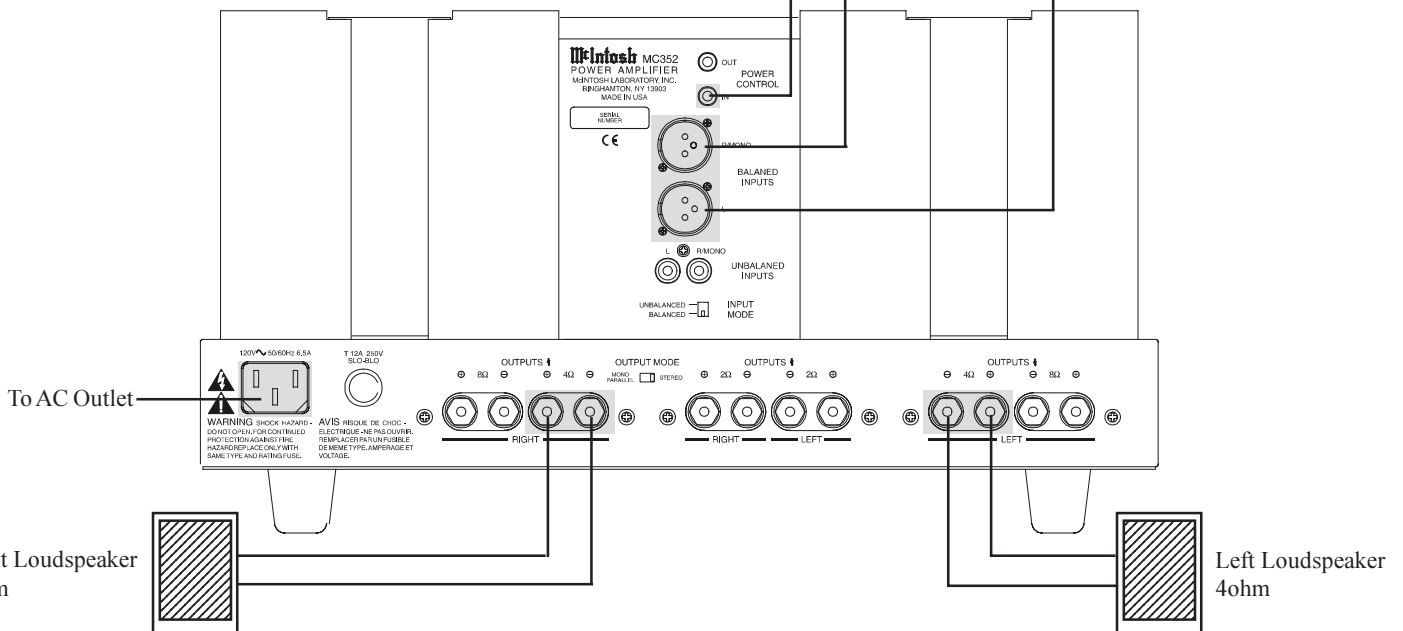
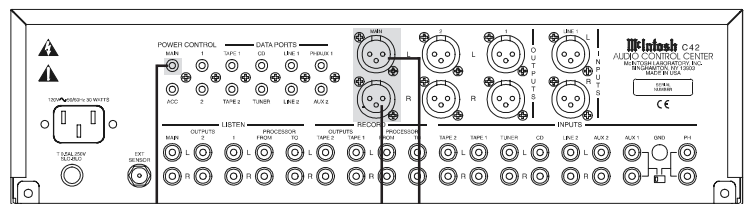

MC352 Front Panel Displays and Controls

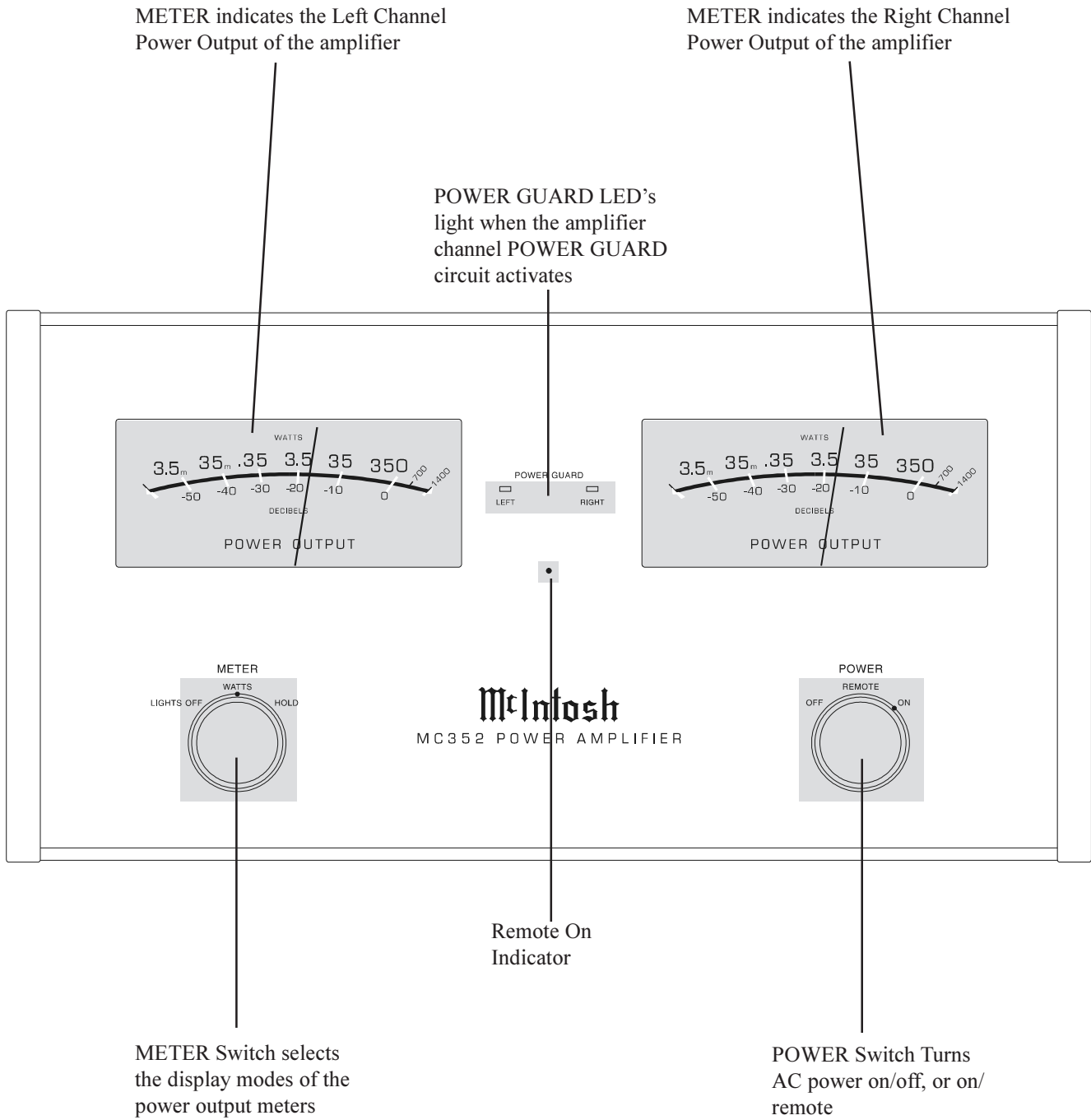

How to Operate the MC352

Power On

To have the MC352 automatically turn on or off when a control center turns on or off, rotate the power switch to the remote position. For manual operation, rotate the power switch to the on or off position as desired.

Note: There must be a power control connection between the MC352 and the McIntosh Control Center, in order for the remote power turn on to function.

Meter Selection

Rotate the meter mode switch to select the meter operation mode you desire:

- Lights Off - Meter lights are turned off and the meters will continue to indicate the power output.
- Watts- The meters respond to all the musical information being produced by the amplifier and indicate to an accuracy of at least 95% of the power output of either amplifier channel with only a single cycle of a 2000Hz tone burst.
- Hold - The meter pointer is locked to the highest power peak in a sequence of peaks. The meter is electronically held to this power level until another higher power peak passes through the amplifier. The meter pointer will then rise to the newer higher indication. If no further power peaks are reached, the meter pointer will very slowly return to its rest position or lower power level. The decay rate is approximately 6 dB per minute.

Note: The MC352 Power Output Meters indicate the actual wattage delivered to the loudspeakers by responding to the combination of current and voltage output.

Output Mode Switch

The Output Mode Switch allows the two MC352 channels to be used in two different operating configurations.

- Stereo - Both channels operate independently as left and right 350 watt amplifiers for stereo applications.
- Mono - The right channel input signal is sent to both amplifier channels, which are combined at the outputs for a 700 watt mono amplifier.

Input Mode Switch

The Input Mode Switch allows you to select either the Balanced or Unbalanced inputs.

How to Operate the MC352 in Mono

The MC352 can be operated in Mono Mode as a 700 watt amplifier with output impedances of 1, 2 and 4 ohms. Refer to the shaded areas in figure 8.

1. Set the Output Mode Switch to the MONO PARALLEL position.
2. Connect the cable from the signal source equipment to the R MONO Balanced or Unbalanced input and set the Input Mode switch to match.
3. Connect the loudspeaker cables to the appropriate terminals to match the impedance of your loudspeakers.

Note: Mono Parallel output connections require the chosen impedance Plus and Minus terminals of one channel be connected to the matching terminals on the other channel. Refer to the connecting chart below.

Loudspeaker Impedance	⊖ (Negative) Output Terminal	⊕ (Positive) Output Terminal
1Ω (ohms)	Left & Right 2Ω	Left & Right 2Ω
2Ω (ohms)	Left & Right 4Ω	Left & Right 4Ω
4Ω (ohms)	Left & Right 8Ω	Left & Right 8Ω

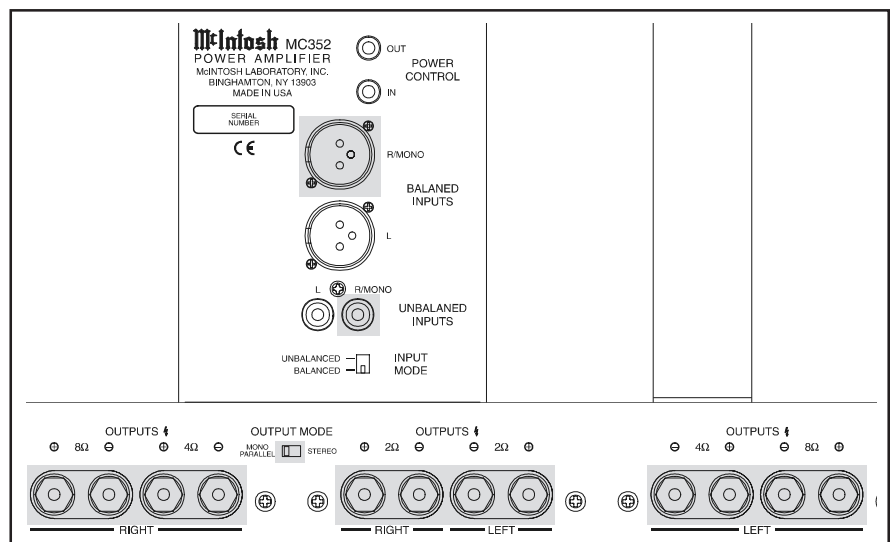

Figure 8

Specifications

Power Output Stereo

350 watts into 2, 4 or 8 ohm loads is the minimum sine wave continuous average power output per channel both channels operating.

Power Output Mono Parallel

700 watts into 1, 2 or 4 ohm loads is the minimum sine wave continuous average power output.

Output Load Impedance

2, 4 or 8 ohms (Stereo Mode)

1, 2 or 4 ohms (Mono Mode)

Rated Power Band

20Hz to 20,000Hz

Dynamic Headroom

2.1dB

Frequency Response

+0, -0.25dB from 20Hz to 20,000Hz

+0, -3dB from 10Hz to 100,000Hz

Total Harmonic Distortion

0.005% maximum at any power level from 250 milliwatts to rated power per channel from 20Hz to 20,000Hz, all channels operating.

Intermodulation Distortion

0.005% maximum if instantaneous peak output per channel does not exceed twice the rated output with all channels operating for any combination of frequencies from 20Hz to 20,000Hz.

Signal To Noise Ratio (A Weighted)

85dB Unbalanced (116dB below rated output)

115dB Balanced (124dB below rated output)

Sensitivity

1.9 Volts Unbalanced Input

3.8 Volts Balanced Input

Input Impedance

20,000 ohms Unbalanced

40,000 ohms Balanced

Damping Factor

Greater than 40

Power Requirements

100 Volts, 50/60Hz at 14.5 amps

110 Volts, 50/60Hz at 13.0 amps

120 Volts, 50/60Hz at 12.0 amps

220 Volts, 50/60Hz at 6.50 amps

230 Volts, 50/60Hz at 6.25 amps

240 Volts, 50/60Hz at 6.00 amps

NOTE: Refer to the rear panel of the MC352 for the correct voltage.

Dimensions

Front Panel: 17.50 inches (44.5cm) wide, 8.89 inches (22.58cm) high. Depth behind front mounting panel is 21 inches (53.3cm) including clearance for connectors. Panel clearance required in front of mounting panel is 1.125 inches (2.9cm).

Weight

105 pounds (47.63Kg) net, 138 pounds (63Kg) in shipping carton

Packing Instructions

In the event it is necessary to repack the equipment for shipment, the equipment must be packed exactly as shown below. It is very important that the four plastic feet are attached to the bottom of the equipment. Four 1/4-20 x 2-1/4" cap screws and washers must be used to fasten the unit securely to the shipping skid. This will ensure the proper equipment location on the shipping skid. Failure to do this will result in shipping damage.

Use the original shipping carton and interior parts only if they are all in good serviceable condition. If a shipping carton or any of the interior part(s) are needed, please call or write Customer Service Department of McIntosh Laboratory. Please see the Part List for the correct part numbers.

Quantity	Part Number	Description
1	034051	Shipping carton bottom
1	034052	Shipping carton top
2	034054	Foam pad (front and rear)
2	034053	Foam pad (sides)
2	034055	Foam pad (top and bottom)
1	035050	Inner carton top
1	034049	Inner carton bottom
1	034048	Foam pad inner carton
1	034056	Shipping skid
4	101212	1/4-20 x 2-1/4" cap screw
4	104058	Flat washer
1	049289	Shipping carton complete with all the above parts

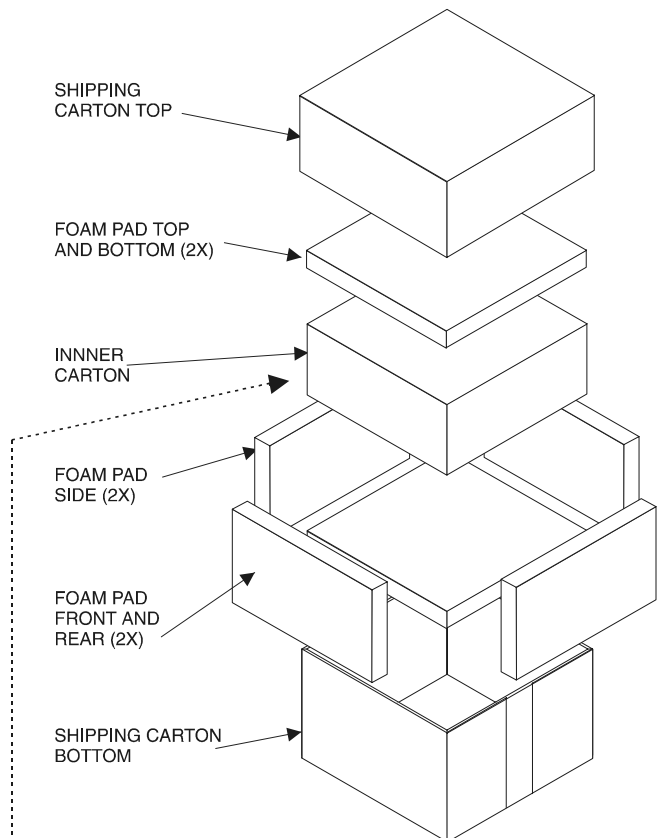
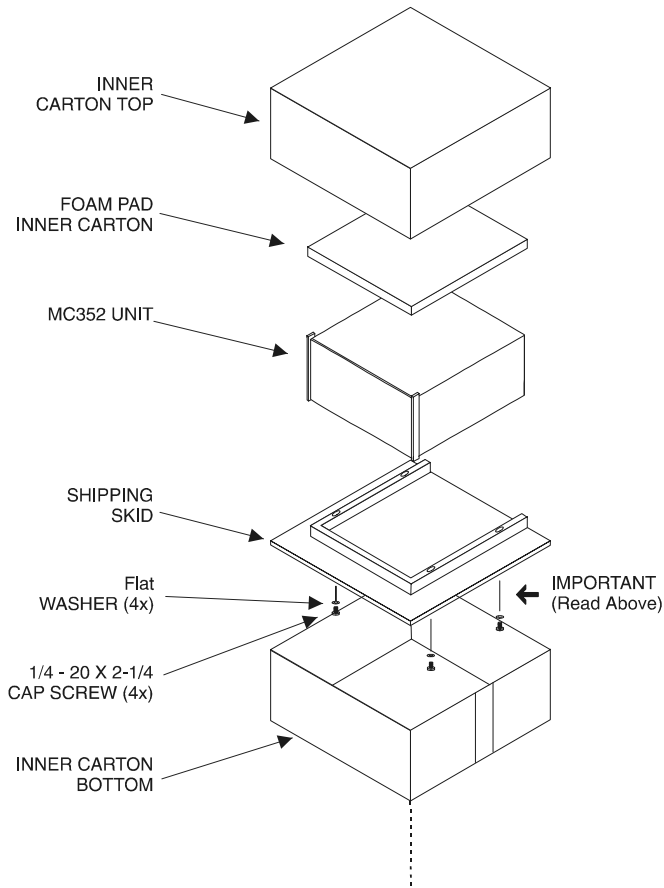

McIntosh[®]

McIntosh Laboratory, Inc.
2 Chambers Street
Binghamton, NY 13903

McIntosh Part No. 040626