

# DENON

## AV SURROUND PRE-AMPLIFIER/TUNER

# AVP-8000

## OPERATING INSTRUCTIONS

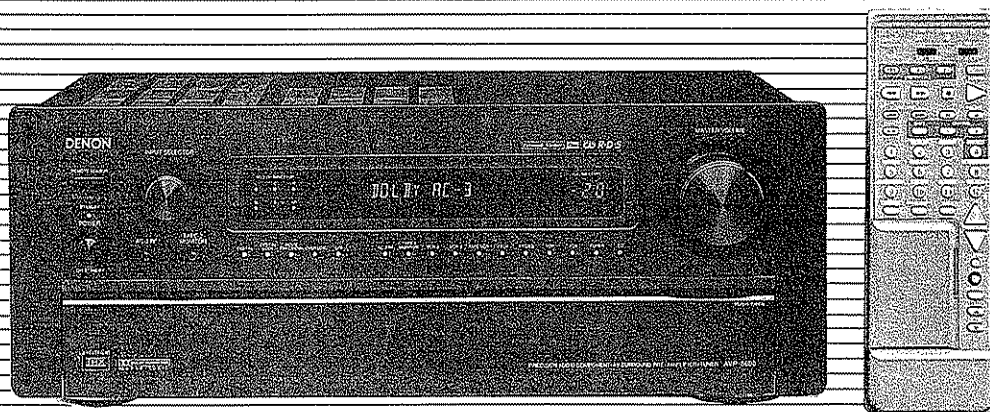

"SERIAL NO. \_\_\_\_\_  
PLEASE RECORD UNIT SERIAL NUMBER ATTACHED TO THE REAR OF THE  
CABINET FOR FUTURE REFERENCE"

## SAFETY PRECATIONS

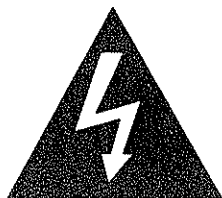

### CAUTION

**RISK OF ELECTRIC SHOCK  
DO NOT OPEN**



**CAUTION: TO REDUCE THE RISK OF ELECTRIC SHOCK,  
DO NOT REMOVE COVER (OR BACK). NO USER SERVICE-  
ABLE PARTS INSIDE. REFER SERVICING TO QUALIFIED  
SERVICE PERSONNEL.**



The lightning flash with arrowhead symbol, within an equilateral triangle, is intended to alert the user to the presence of uninsulated "dangerous voltage" within the product's enclosure that may be of sufficient magnitude to constitute a risk of electric shock to persons.



The exclamation point within an equilateral triangle is intended to alert the user to the presence of important operating and maintenance (servicing) instructions in the literature accompanying the appliance.

**WARNING: TO REDUCE THE RISK OF FIRE OR ELECTRIC SHOCK, DO NOT EXPOSE THIS  
APPLIANCE TO RAIN OR MOISTURE.**

### CAUTION

TO PREVENT ELECTRIC SHOCK DO NOT USE THIS (POLARIZED) PLUG WITH AN EXTENSION CORD, RECEPTACLE OR OTHER OUTLET UNLESS THE BLADES CAN BE FULLY INSERTED TO PREVENT BLADE EXPOSURE.

### ATTENTION

POUR PREVENIR LES CHOCS ELECTRIQUES NE PAS UTILISER CETTE FICHE POLARISEE AVEC UN PROLONGATEUR UNE PRISE DE COURANT OU UNE AUTRE SORTIE DE COURANT, SAUF SI LES LAMES PEUVENT ETRE INSEREES A FOND SANS EN LAISSER AUCUNE PARTIE A DECOUVERT.

# SAFETY INSTRUCTIONS

1. Read Instructions – All the safety and operating instructions should be read before the appliance is operated.
2. Retain Instructions – The safety and operating instructions should be retained for future reference.
3. Heed Warnings – All warnings on the appliance and in the operating instructions should be adhered to.
4. Follow Instructions – All operating and use instructions should be followed.
5. Water and Moisture – The appliance should not be used near water – for example, near a bathtub, washbowl, kitchen sink, laundry tub, in a wet basement, or near a swimming pool, and the like.
6. Carts and Stands – The appliance should be used only with a cart or stand that is recommended by the manufacturer.
- 6A. An appliance and cart combination should be moved with care. Quick stops, excessive force, and uneven surfaces may cause the appliance and cart combination to overturn.
7. Wall or Ceiling Mounting – The appliance should be mounted to a wall or ceiling only as recommended by the manufacturer.
8. Ventilation – The appliance should be situated so that its location or position does not interfere with its proper ventilation. For example, the appliance should not be situated on a bed, sofa, rug, or similar surface that may block the ventilation openings; or, placed in a built-in installation, such as a bookcase or cabinet that may impede the flow of air through the ventilation openings.
9. Heat – The appliance should be situated away from heat sources such as radiators, heat registers, stoves, or other appliances (including amplifiers) that produce heat.
10. Power Sources – The appliance should be connected to a power supply only of the type described in the operating instructions or as marked on the appliance.
11. Grounding or Polarization – Precautions should be taken so that the grounding or polarization means of an appliance is not defeated.
12. Power-Cord Protection – Power-supply cords should be routed so that they are not likely to be walked on or pinched by items placed upon or against them, paying particular attention to cords at plugs, convenience receptacles, and the point where they exit from the appliance.
14. Cleaning – The appliance should be cleaned only as recommended by the manufacturer.
15. Power Lines – An outdoor antenna should be located away from power lines.
16. Outdoor Antenna Grounding – If an outside antenna is connected to the receiver, be sure the antenna system is grounded so as to provide some protection against voltage surges and built-up static charges. Article 810 of the National Electrical Code, ANSI/NFPA 70, provides information with regard to proper grounding of the mast and supporting structure, grounding of the lead-in wire to an antenna-discharge unit, size of grounding conductors, location of antenna-discharge unit, connection to grounding electrodes, and requirements for the grounding electrode. See Figure A.
17. Nonuse Periods – The power cord of the appliance should be unplugged from the outlet when left unused for a long period of time.
18. Object and Liquid Entry – Care should be taken so that objects do not fall and liquids are not spilled into the enclosure through openings.
19. Damage Requiring Service – The appliance should be serviced by qualified service personnel when:
  - A. The power-supply cord or the plug has been damaged; or
  - B. Objects have fallen, or liquid has been spilled into the appliance; or
  - C. The appliance has been exposed to rain; or
  - D. The appliance does not appear to operate normally or exhibits a marked change in performance; or
  - E. The appliance has been dropped, or the enclosure damaged.
20. Servicing – The user should not attempt to service the appliance beyond that described in the operating instructions. All other servicing should be referred to qualified service personnel.



FIGURE A  
EXAMPLE OF ANTENNA GROUNDING  
AS PER NATIONAL  
ELECTRICAL CODE

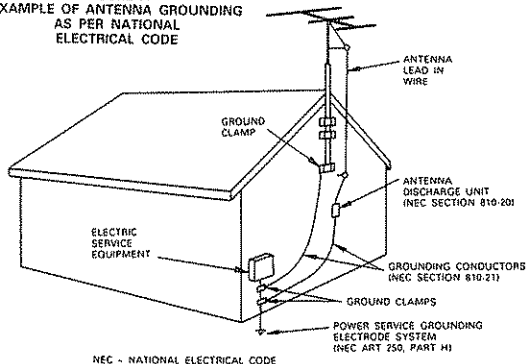





NEC - NATIONAL ELECTRICAL CODE

## TABLE OF CONTENTS

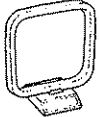
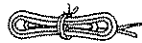

<table border="0" style="width: 100%;"> <tr><td>1 Note on Use .....</td><td style="text-align: right;">4</td></tr> <tr><td>2 Before Using .....</td><td style="text-align: right;">5</td></tr> <tr><td>3 Cautions on Installation .....</td><td style="text-align: right;">5</td></tr> <tr><td>4 Cautions on Handling .....</td><td style="text-align: right;">5</td></tr> <tr><td>5 Connections .....</td><td style="text-align: right;">6~9</td></tr> <tr><td>6 System Setup .....</td><td style="text-align: right;">10~16</td></tr> <tr><td>7 Remote Control Unit .....</td><td style="text-align: right;">17~20</td></tr> <tr><td>8 Operations .....</td><td style="text-align: right;">21~25</td></tr> </table>	1 Note on Use .....	4	2 Before Using .....	5	3 Cautions on Installation .....	5	4 Cautions on Handling .....	5	5 Connections .....	6~9	6 System Setup .....	10~16	7 Remote Control Unit .....	17~20	8 Operations .....	21~25	<table border="0" style="width: 100%;"> <tr><td>9 Using the Surround Function .....</td><td style="text-align: right;">25 ~ 29</td></tr> <tr><td>10 Listening to the Radio .....</td><td style="text-align: right;">29 ~ 34</td></tr> <tr><td>11 Last Function Memory .....</td><td style="text-align: right;">34</td></tr> <tr><td>12 Initialization of the Microprocessor .....</td><td style="text-align: right;">34</td></tr> <tr><td>13 Troubleshooting .....</td><td style="text-align: right;">35</td></tr> <tr><td>14 Specifications .....</td><td style="text-align: right;">36</td></tr> </table>	9 Using the Surround Function .....	25 ~ 29	10 Listening to the Radio .....	29 ~ 34	11 Last Function Memory .....	34	12 Initialization of the Microprocessor .....	34	13 Troubleshooting .....	35	14 Specifications .....	36
1 Note on Use .....	4																												
2 Before Using .....	5																												
3 Cautions on Installation .....	5																												
4 Cautions on Handling .....	5																												
5 Connections .....	6~9																												
6 System Setup .....	10~16																												
7 Remote Control Unit .....	17~20																												
8 Operations .....	21~25																												
9 Using the Surround Function .....	25 ~ 29																												
10 Listening to the Radio .....	29 ~ 34																												
11 Last Function Memory .....	34																												
12 Initialization of the Microprocessor .....	34																												
13 Troubleshooting .....	35																												
14 Specifications .....	36																												

### ● ACCESSORIES

Check that the following parts are included in addition to the main unit:

① Operating instructions ..... 1	② Warranty ..... 1	⑤ AM loop antenna ..... 1	⑥ FM indoor antenna ..... 1	⑦ FM antenna adaptor ..... 1
③ Remote control unit (RC-196) ..... 1	④ R6P/AA batteries ..... 2			
				

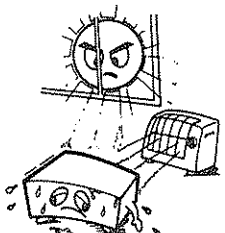
### 1 NOTE ON USE

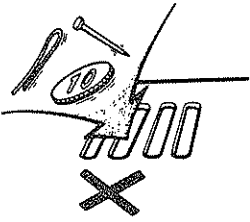
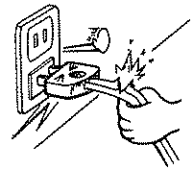
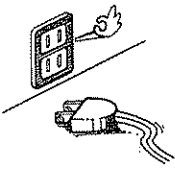
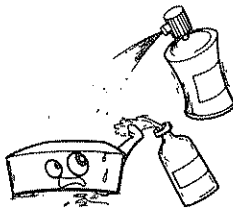
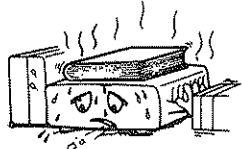
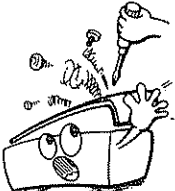
 <ul style="list-style-type: none"> <li>● Avoid high temperatures Allow for sufficient heat dispersion when installed on a rack.</li> </ul>	 <ul style="list-style-type: none"> <li>● Keep the set free from moisture, water, and dust.</li> </ul>	 <ul style="list-style-type: none"> <li>● Do not let foreign objects in the set.</li> </ul>
 <ul style="list-style-type: none"> <li>● Handle the power cord carefully. Hold the plug when unplugging the cord.</li> </ul>	 <ul style="list-style-type: none"> <li>● Unplug the power cord when not using the set for long periods of time.</li> </ul>	 <ul style="list-style-type: none"> <li>● Do not let insecticides, benzene, and thinner come in contact with the set.</li> </ul>
 <ul style="list-style-type: none"> <li>*(For sets with ventilation holes)</li> <li>● Do not obstruct the ventilation holes.</li> </ul>	 <ul style="list-style-type: none"> <li>● Never disassemble or modify the set in any way.</li> </ul>	

## 2 BEFORE USING

Pay attention to the following before using this unit:

- **Moving the set**  
To prevent short circuits or damaged wires in the connection cords, always unplug the power cord and disconnect the connection cords between all other audio components when moving the set.
- **Before turning the power switch on**  
Check once again that all connections are proper and that there are not problems with the connection cords. Always set the power switch to the standby position before connecting and disconnecting connection cords.

## 3 CAUTIONS ON INSTALLATION

Noise or disturbance of the picture may be generated if this unit or any other electronic equipment using microprocessors is used near a tuner or TV.

If this happens, take the following steps:

- Install this unit as far as possible from the tuner or TV.
- Set the antenna wires from the tuner or TV away from this unit's power cord and input/output connection cords.
- Noise or disturbance tends to occur particularly when using indoor antennas or 300  $\Omega$  /ohms feeder wires. **We recommend using outdoor antennas and 75  $\Omega$  /ohms coaxial cables.**

- **Store this instructions in a safe place.**  
After reading, store this instructions along with the warranty in a safe place. Also fill in the items on the back page for your convenience.
- **Note that the illustrations in this instructions may differ from the actual set for explanation purposes.**

## 4 CAUTIONS ON HANDLING

- **Switching the input function when input jacks are not connected**  
A clicking noise may be produced if the input function is switched when nothing is connected to the input jacks. If this happens, either turn down the MASTER VOLUME control or connect components to the input jacks.
- **Muting of PRE OUT jacks**  
The PRE OUT jacks include a muting circuit. Because of this, the output signals are greatly reduced for several seconds after the power switch is turned on or input function, surround mode or any other set-up is changed. If the volume is turned up during this time, the output will be very high after the muting circuit stops functioning. Always wait until the muting circuit turns off before adjusting the volume.

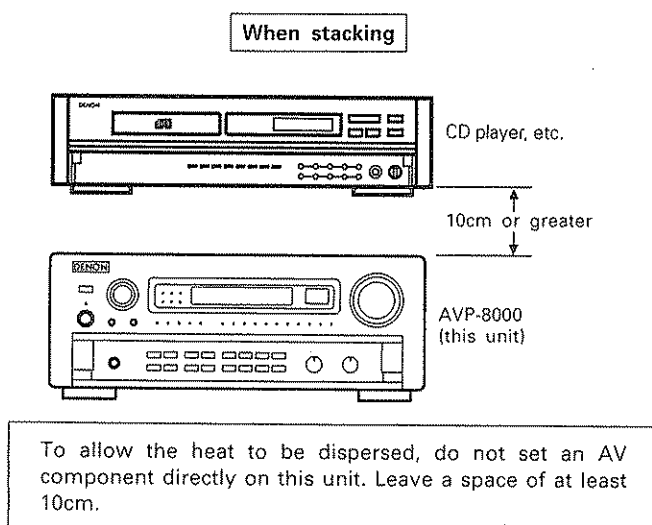

- **Opening and closing the door**  
This unit has a door on the front panel. Press the "PUSH OPEN" mark on the upper right side of the door to unlatch and open it. To close it, press it until a click is heard.

**NOTE:** The door opens out automatically once it is unlatched, but it may stop halfway. This is not a malfunction. In this case, pull down the door lightly to open it.

## 5 CONNECTIONS

- Do not plug in the power cord until all connections have been completed.
- Be sure to connect the left and right channels properly (left with left, right with right).
- Insert the plugs securely. Incomplete connections will result in the generation of noise.
- Use the AC OUTLETS for audio equipment only. Do not use them for hair driers, etc.

- Note that binding pin plug cords together with power cords or placing them near a power transformer will result in generating hum or other noise.
- Noise or humming may be generated if a connected audio equipment is used independently without turning the power of this unit on. If this happens, turn on the power of the this unit.

### 5-1 Connecting the audio components

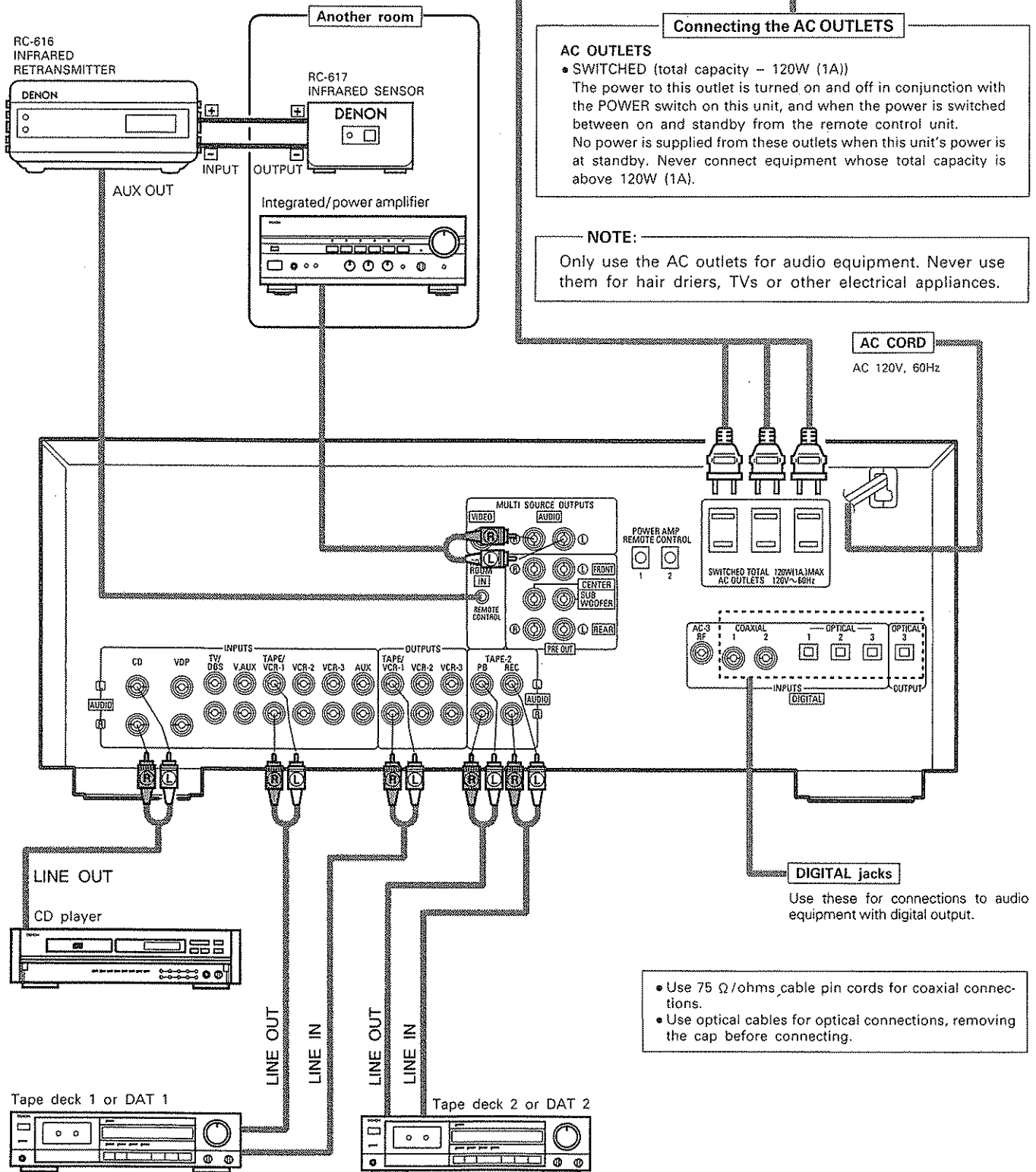

## 5-2 Connecting the video equipments

To connect the video signal, connect using a 75 Ω/ohms video signal cable cord. Using an improper cable can result in a drop in sound quality.

LD player, CDV player, etc.

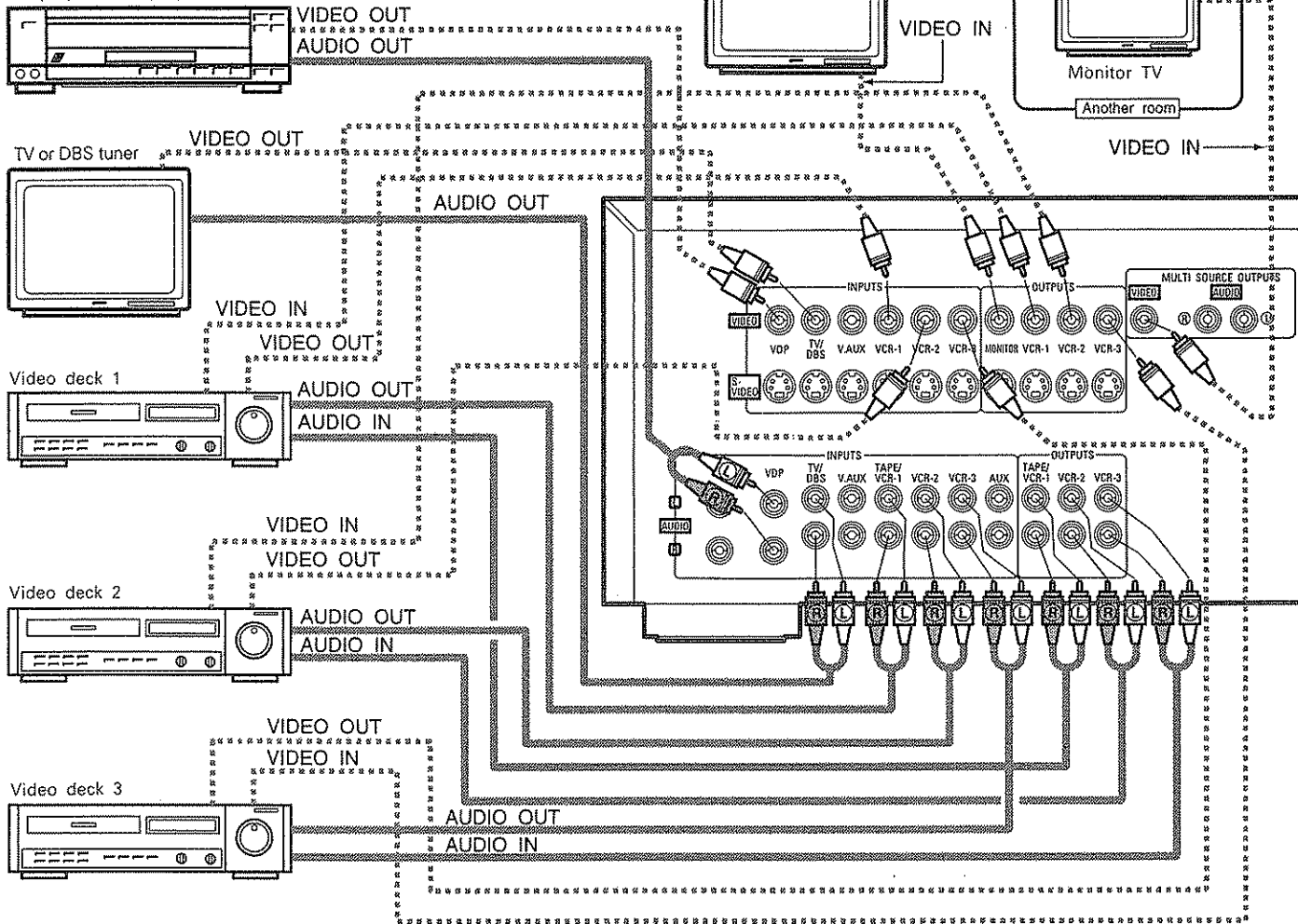

## 5-3 Connecting the S-video terminals

LD player, CDV player, etc.

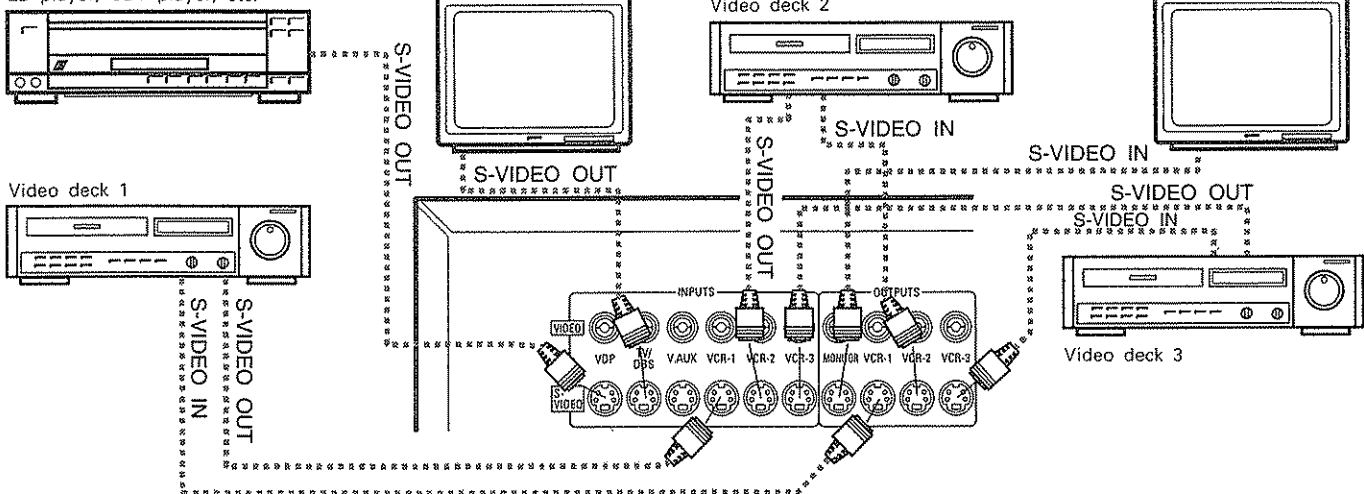

- **A note on the S input jacks**

The input selectors for the S inputs and pin jack inputs work in conjunction with each other.

- **Precaution when using S-jacks**

This unit's S-jacks (input and output) and video pin jacks (input and output) have independent circuit structures, so that video signals input from the S-jacks are only output from the S-jack outputs and video signals input from the pin jacks are only output from the pin jack outputs.

When connecting this unit with equipment that is equipped with S-jacks, keep the above point in mind and make connections according to the equipment's instruction manuals.

## 5-4 Connecting the video equipments with Digital jacks

LD player, etc. equipped with AC-3 RF output

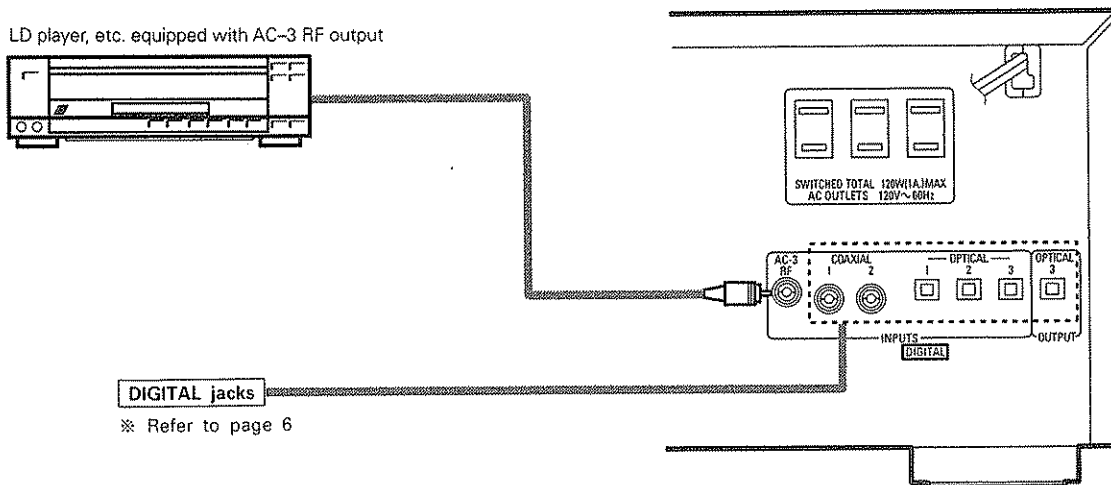

## 5-5 Connecting the antenna terminals

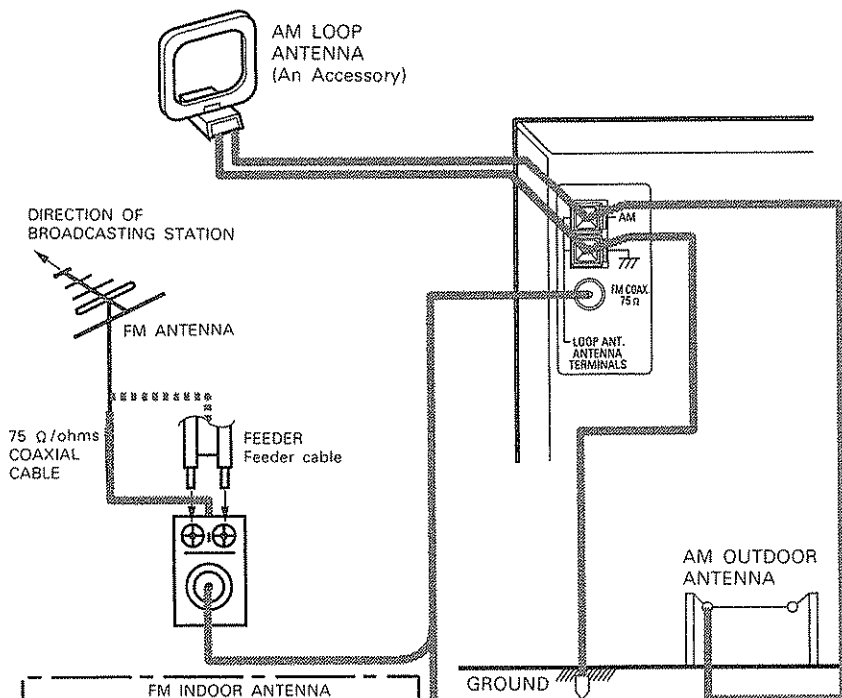

### Note to CATV system installer:

This reminder is provided to call the CATV system installer's attention to Article 820-40 of the NEC which provides guidelines for proper grounding and, in particular, specifies that the cable ground shall be connected to the grounding system of the building, as close to the point of cable entry as practical.

### Notes:

- Do not connect two FM antennas simultaneously.
- Even if an external AM antenna is used, do not disconnect the AM loop antenna.
- Make sure AM loop antenna lead terminals do not touch metal parts of the panel.

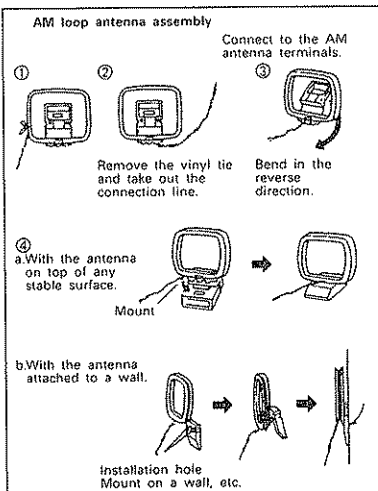
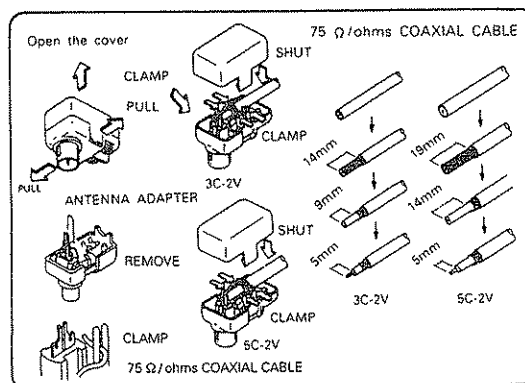

### Connection of AM antennas

1. Push the lever.
2. Insert the conductor.
3. Return the lever.

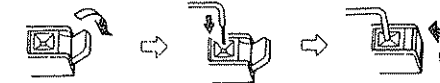

## 5-6 Connections with the power amplifier

- For optimal multichannel sound performance, we recommend the use of THX<sup>®</sup> certified power amplifiers (such as the DENON POA-8200 and POA-8300) and THX loudspeaker systems.

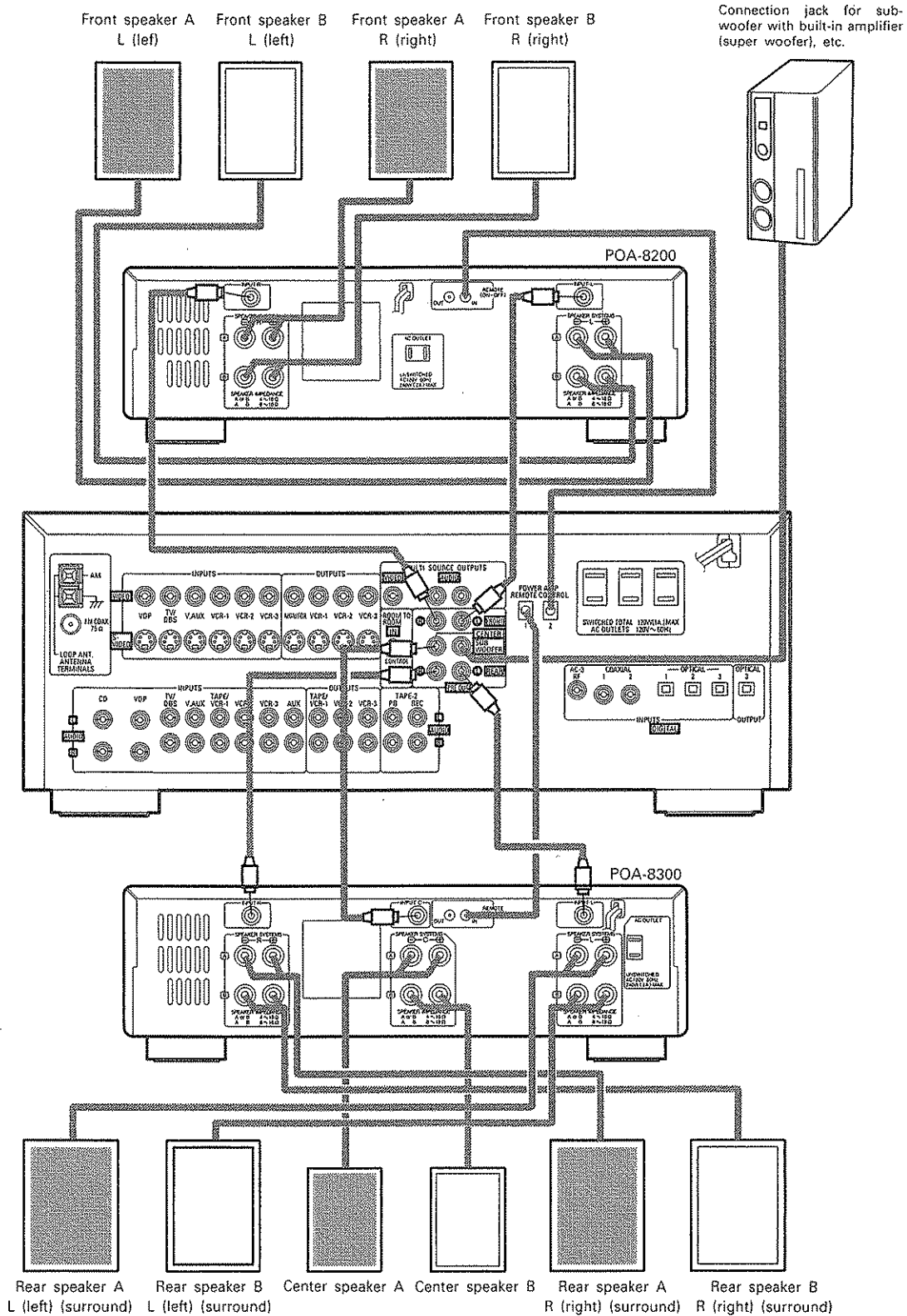

### • Precautions when connecting speakers

If a speaker is placed near a TV or video monitor, the colors on the screen may be disturbed by the speaker's magnetism. If this should happen, move the speaker away to a position where it does not have this effect.

### • POWER AMPLIFIER REMOTE CONTROL jacks

These jacks are for setting Denon power amplifiers to the on-standby mode in link with the POWER switch on this unit. Use the cables included with the power amplifier for connection. Up to two power amplifiers can be controlled.

## 6 SYSTEM SETUP

After connections with other components have been made, make the various settings on the monitor using this unit's on-screen display. These settings must be made in order to complete the AV system in your listening room.

### NOTES:

- The output from the S MONITOR OUT terminal has priority for the on-screen display. If you want to always output the on-screen display signals to the video output, do not connect a cable to the S MONITOR OUT terminal.
- The on-screen display is not displayed for the MULTI SOURCE MONITOR OUT terminal.
- This model's on-screen function is designed for high resolution monitor displays. Small characters may be difficult to read on small displays or low resolution TVs.

Use the following buttons on the remote control unit to make the settings:

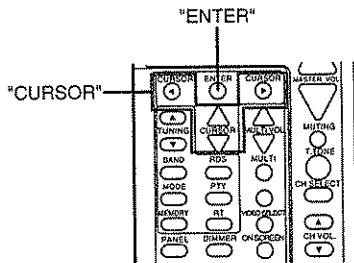

### "ENTER" button

Press this to switch the display on the screen. Also use this button to complete the setting on the screen.

### "CURSOR" buttons

- ◀ and ▶: Use these to move the cursors (◀ and ▶) to the left and right on the screen.
- ▲ and ▼: Use these to move the cursors (▲ and ▼) up and down on the screen.

### 6-1 Before Setting Up the System

1. Turn on the power and press the ENTER button. The "Menu" screen (screen 1) appears on the monitor.

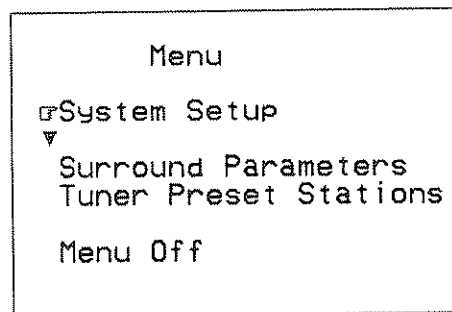
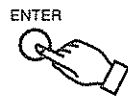

(screen 1)

2. Use the CURSOR buttons to specify "System Setup".



3. Press the ENTER button to switch the screen.

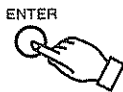

The "System Setup Menu" screen (screen 2) appears on the monitor.

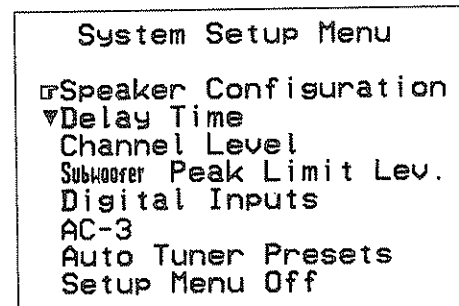

(screen 2)

### 6-2 Setting the Speaker Configuration

1. Use the CURSOR buttons to specify "Speaker Configuration".



2. Press the ENTER button.



The "Speaker Configuration Menu" screen (screen 3) appears on the monitor.

- Use the CURSOR buttons and select the different types of speakers connected and their size parameters.

To select the speakers:



To select the parameters:

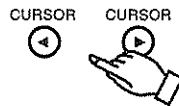

- ※ Large: Select this when using speakers that can fully reproduce low sounds of below 80 Hz.
- ※ Small: Select this when using speakers that cannot reproduce low sounds of below 80 Hz with sufficient volume. When this setting is selected, low frequencies of below 80 Hz are assigned to the subwoofer.
- ※ To take full advantage of the performance of Home THX certified speaker systems, set the front, center and rear speaker size parameters to "Small" and the subwoofer to "Yes". The selected parameters are highlighted.

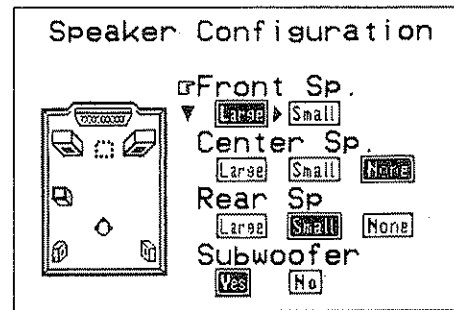

( screen 3 )

- After the above selections are completed, press the ENTER button again. The "System Setup Menu" screen reappears.

### 6-3 Setting the Delay Time

Input the listening position and the distance of the different speakers.1.

- Use the CURSOR buttons to specify "Delay Time" from the "System Setup Menu" screen (screen 4).

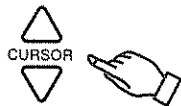

- Press the ENTER button.

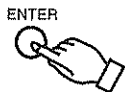

The "Delay Time" screen (screen 5) appears on the monitor.

- Use the CURSOR buttons to specify the unit of distance.

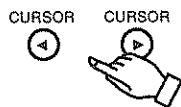

**NOTE:** The settings are reset to their initial values when switching between meters and feet.

- Use the CURSOR buttons to input the listening position and the distance of the different speakers. (screen 6-A)

To select the speakers:



To select the distance:

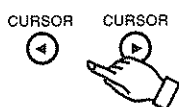

- ※ Select "Default" to return to the initial settings.

- After the above selections are completed, press the ENTER button again. The "System Setup Menu" screen reappears. This procedure automatically sets the optimum surround delay time for the listening room.

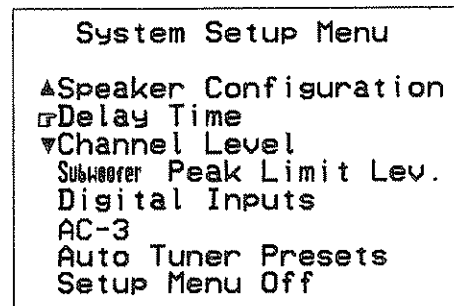

( screen 4 )

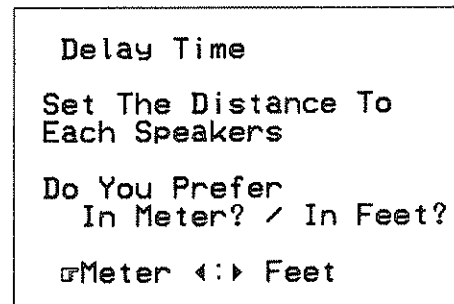

( screen 5 )

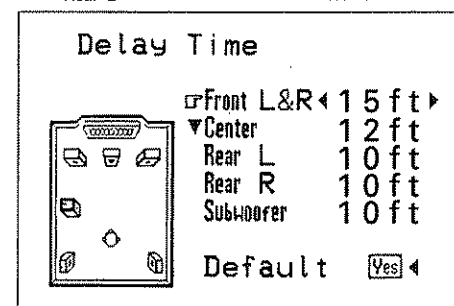
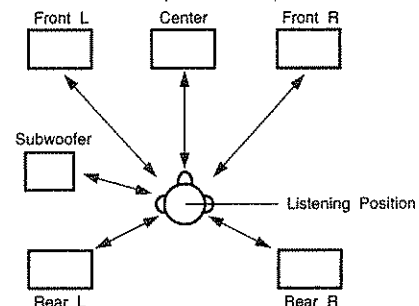

( screen 6-A )

※ Please note that the difference of distance for every speaker should be 15 ft (4.5 m) or less. If you set an invalid distance, a CAUTION notice, such as screen 6-B will appear. In this case, please relocate the blinking speaker(s) so that its distance is no larger than the value shown in highlighted line. Then press the ENTER button again.

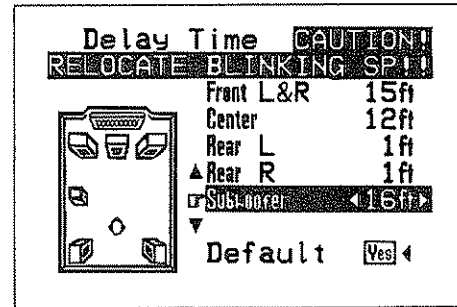

( screen 6-B )

## 6-4 Setting the Channel Level

Use test tones to adjust the volume of the different speakers.

1. Use the CURSOR buttons to specify "Channel Level" from the "System Setup Menu" screen. (screen 7)



2. Press the ENTER button.



The "Channel Level" screen (screen 8) appears on the monitor.

3. Use the CURSOR buttons to select "Test Tone Mode", then select "Auto" or "Manual".

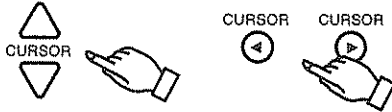

4. Use the CURSOR buttons to select "Test Tone Start", then select "Yes".

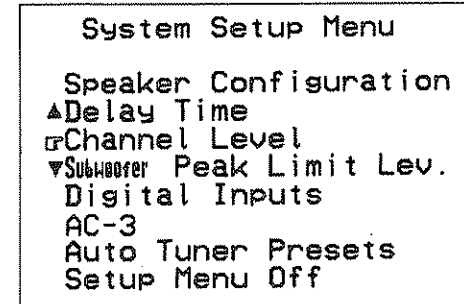
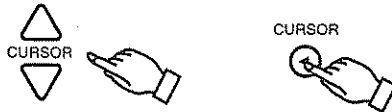

( screen 7 )

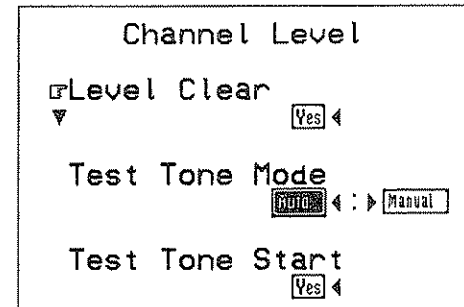

( screen 8 )

5. a. If the "Auto" mode is selected:  
Test tones are automatically emitted from the different speakers.  
The test tones are emitted from the different speakers in the following order, at 4-second intervals the first time and second time around, 2-second intervals the third time around and on:



Use the CURSOR buttons to adjust all the speakers to the same volume. (screen 9)



- b. If the "Manual" mode is selected:  
Use the cursor buttons to select the speakers from which to emit the test tones and adjust the volume. (screen 10)

To adjust the volume:



To select the speaker:

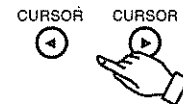

The level of each channel should be adjusted for 75 dB (C-weighted, slow mode) on a sound level meter at the listening position. If a sound level meter is not available adjust the channels by ear so the sound levels are the same. Because adjusting the subwoofer level test tone by ear is difficult, use a well known music selection and adjust for natural balance.

**NOTE:** When adjusting the level of an active subwoofer system, you may also need to adjust the subwoofer's own volume control.

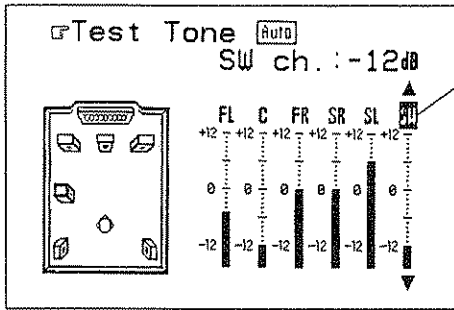

( screen 9 )

The test tone is emitted from the speaker whose indicator is highlighted.

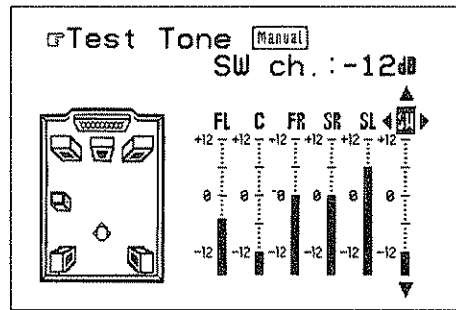

( screen 10 )

6. After the above settings are completed, press the ENTER button. The "System Setup Menu" screen reappears.

To cancel the settings, select "Level Clear" and "Yes" on the "Channel Level" screen, then make the settings again.

- NOTE:** 1. The output channel levels for all the surround modes are set to the same conditions when the channel level setting on the system setup menu is conducted.  
2. When the level clear operation is performed, all channel levels for all modes are set to 0 dB.

The speaker volume adjustment using the test tones can be performed from the remote control unit as well as from the "System Setup Menu".

1. Press the Test Tone button
2. Test tones are emitted from the different speakers. Adjust so that the volumes of the all the speakers are equal.
3. Turn the test tone off.

※ The remote control unit's T. TONE button can only be used when in the Dolby Surround and Home THX Cinema modes.  
**NOTE:** Only the "Auto" mode can be used when the test tone button is pressed. In addition, the adjusted output level is only backed up for the Dolby Surround or Home THX Cinema mode.

### 6-5 Subwoofer Peak Limit Level Setting

This unit features a subwoofer peak limit control which prevents distortion and damage in the loudspeaker system by controlling the maximum bass volume level. With this feature you may set the maximum bass level for the system. This feature operates with or without a subwoofer in the system.

1. Use the CURSOR buttons to specify "Subwoofer Peak Limit Lev." from the "System Setup Menu" screen. (screen 11)

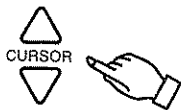

2. Press the ENTER button.



The "Subwoofer Peak Limit Level Setting" screen (screen 12) appears.

**System Setup Menu**

Speaker Configuration  
Delay Time  
▲Channel Level  
▣Subwoofer Peak Limit Lev.  
▼Digital Inputs  
AC-3  
Auto Tuner Presets  
Setup Menu Off

( screen 11 )

**Subwoofer Peak  
Limit Level Setting**

Find The Level When  
Distortion Begins.

▣Peak Limiter Off Yes ◀  
▼Setting Start Yes ◀

( screen 12 )

- Use the CURSOR buttons to select "Setting Start" and "Yes".



The screen changes (screen 13) and a test noise is output from the subwoofer. (Clear the subwoofer's peak limit level setting by specifying "Setting Clear" and "Yes".)

- Use the right CURSOR button to increase the test noise output level until the loud-speaker system's bass sound is distorted. Bass distortion can be heard as an obvious overload. When you hear that the bass sound is distorted, press the down CURSOR button.

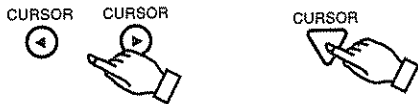

This unit automatically sets the subwoofer peak limit level so the bass level will never be louder than the test noise signal.

- Press the ENTER button to complete the setting, or press the left CURSOR button and select "Want To Try Again?" and "Yes" to redo the setting. (screen 14)
- To redo the setting, press the left CURSOR button at the new screen to select "Are You Sure?" and "Yes" (screen 15), then repeat from step 3 above.

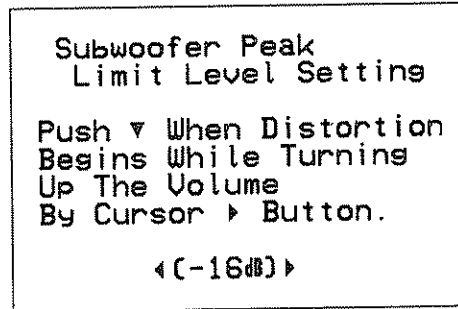

( screen 13 )

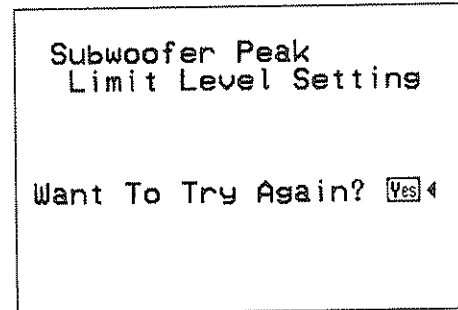

( screen 14 )

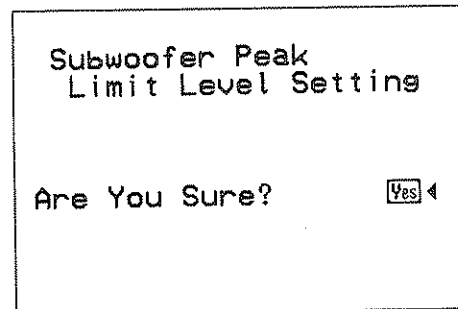

( screen 15 )

## 6-6 Digital Input Setup

Input the types of components connected to the digital input terminals.

- Use the CURSOR buttons to specify "Digital Inputs" from the "System Setup Menu" screen. (screen 16)



- Press the ENTER button.



The "Digital Input Setup" screen appears. (screen 17)

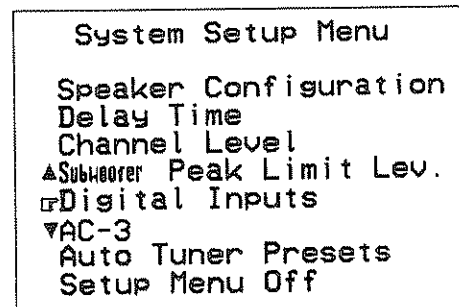

( screen 16 )

- Use the cursor buttons to input the types of components connected to the digital input terminals.

To select the input terminal:



To select the type of component:

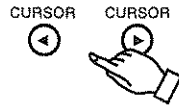

COAXIAL 1	CD
COAXIAL 2	T/VCR-1
OPTICAL 1	TV/DBS
OPTICAL 2	VDP
OPTICAL 3	VCR-3

※ Select "OFF" if nothing is connected.

Table 6-6 Initial Settings

Select "Default" to return to the initial settings.  
The initial settings are set as shown on Table 6-6.

**NOTE:** OPTICAL 3 INPUT is equipped with optical output for digital recording to DAT, MD or Digital VCR.  
Connect the optical recording devices to the input/output of OPTICAL 3 for digital recording.  
For "OPTICAL-3", CD, AUX, VDP, TV/DBS and V.AUX cannot be set.

- After the above settings are completed, press the ENTER button again.  
The "System Setup Menu" screen reappears.

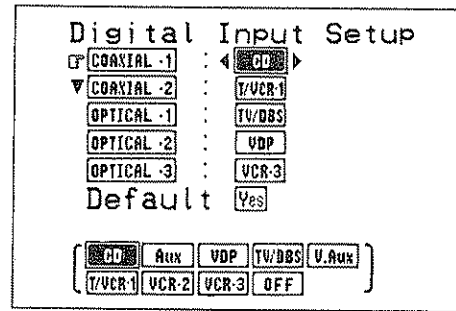

( screen 17 )

## 6-7 AC-3

When playing AC-3 sources, the input level is corrected automatically.  
Set the dialog normalization function.

- Use the CURSOR buttons to specify "AC-3" from the System Setup Menu screen.  
(Screen 18)

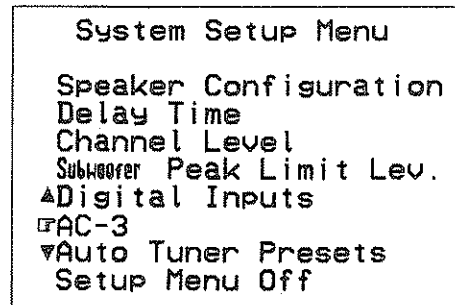
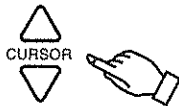

( screen 18 )

- Press the ENTER button.

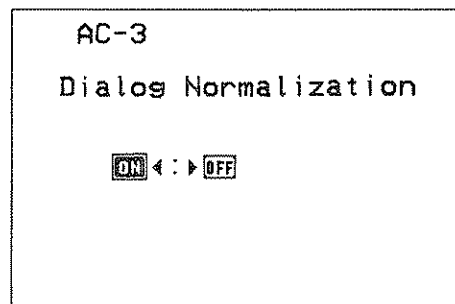
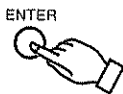

( screen 19 )

The "AC-3" screen appears. (Screen 19)

- Use the CURSOR buttons to select "ON" or "OFF".

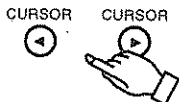

### When playing AC-3 sources

**NOTE:** If dialog normalization is set to "OFF", it may not be possible to set the master volume to greater than -5 dB, depending on the number of speakers and the output channel level setting.  
In the HOME THX CINEMA mode as well, even if dialog normalization is set to "ON", it may not be possible to set the master volume to greater than -5 dB depending on the above conditions.

## 6-8 Auto Tuner Presets

Use this to automatically search for FM broadcasts and store up to 32 stations at preset channels A1 to 8, B1 to 8, C1 to 8 and D1 to 8.

### NOTES:

- If an FM station cannot be preset automatically due to poor reception, use the "Manual tuning" operation to tune in the station, then preset it using the manual "Preset memory" operation.
  - RDS stations are stored in the memory with priority.
1. Use the CURSOR buttons to specify "Auto Tuner Preset" from the "System Setup Menu" screen. (screen 20)



2. Press the ENTER button.

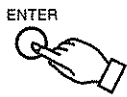

The "Auto Preset Memory" screen appears. (screen 21)

3. Use the CURSOR buttons to select "Yes".

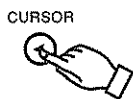

"Search" flashes on the screen and searching begins. "Complete" appears once searching is completed. The display automatically switches to screen 22.

4. Check the broadcast stations stored in the memory. Press the ENTER button. (screen 22)



The monitor switches to the "Menu" screen.

5. Use the CURSOR buttons to specify "Tuner Preset Stations". (screen 23)



6. Press the ENTER button. After checking (screen 24), press the ENTER button again.



- This completes the system setup operations. Once the system is set up, there is no need to make the settings again unless other components or speakers are connected or the speaker layout is changed.

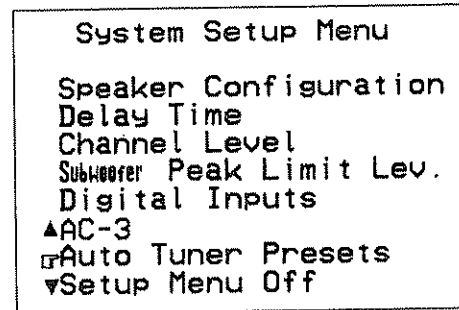

( screen 20 )

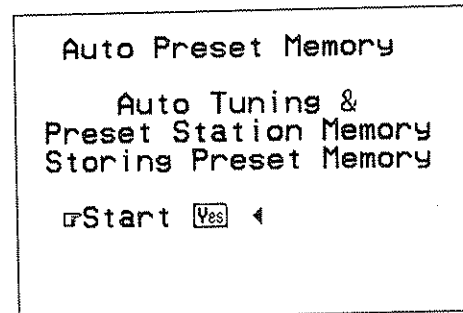

( screen 21 )

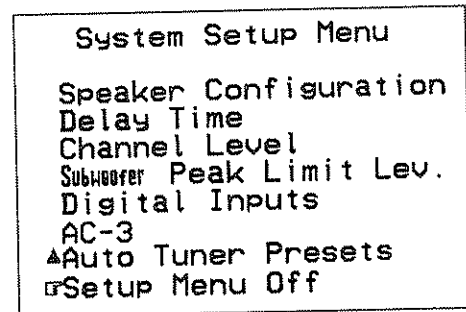

( screen 22 )

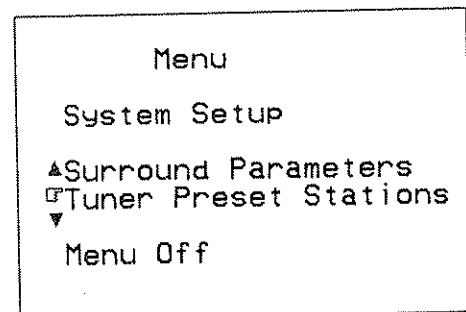

( screen 23 )

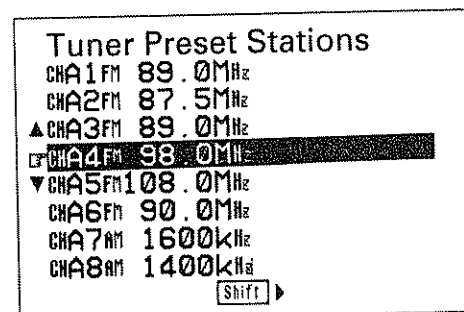

( screen 24 )

## 7 REMOTE CONTROL UNIT

Following the procedure outlined below, insert the batteries before using the remote control unit.

### Range of operation of the remote control unit

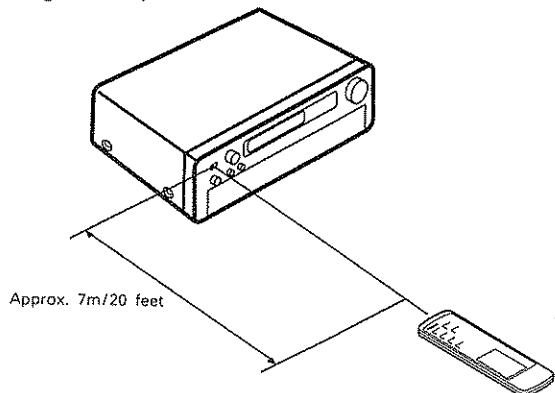

Point the remote control unit at the remote control sensor as shown on the diagram at the left.

#### NOTES:

- The remote control unit can be used from a straight distance of approximately 7 meters/20 feet, but this distance will shorten or operation will become difficult if there are obstacles between the remote control unit and the remote control sensor, if the remote control sensor is exposed to direct sunlight or other strong light, or if operated from an angle.
- Neon signs or other devices emitting pulse-type noise nearby may result in malfunction, so keep the set as far away from such devices as possible.

### Inserting the batteries

1. Open the bottom cover of the remote control unit and remove the battery cover.

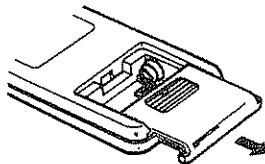

2. Insert the two R6P/AA batteries, matching the ⊕ and ⊖ marks on the batteries with those in the case. Close the bottom cover until it clicks shut.

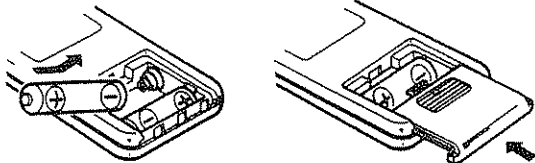

#### NOTES

- Use only AA, R6P, UM-3 batteries for replacement.
- Be sure the polarities are correct. (See the illustration inside the battery compartment.)
- Remove the batteries if the remote control transmitter will not be used for an extended period of time.
- If batteries leak, dispose of them immediately. Avoid touching the leaked material or letting it come in contact with clothing, etc. Clean the battery compartment thoroughly before installing new batteries.
- Have replacement batteries on hand so that the old batteries can be replaced as quickly as possible when the time comes.
- The codes that have been learned may be lost if removed batteries are not replaced within about 5 minutes.

### 7-1 System code buttons

DENON remote-controllable audio components can be controlled using this unit's remote control unit. Note that some components, however, cannot be operated with this remote control unit.

1. Set to slide switch to "AUDIO" ("AVP").



2. Set the slide switch to the position for the component to be operated (CD, DECK or DAT).



3. Use the buttons shown below to operate the component. For details, refer to the respective component's manual.

#### a. For CD players and DATs

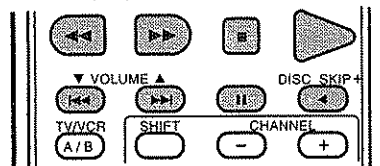

#### b. For tape decks

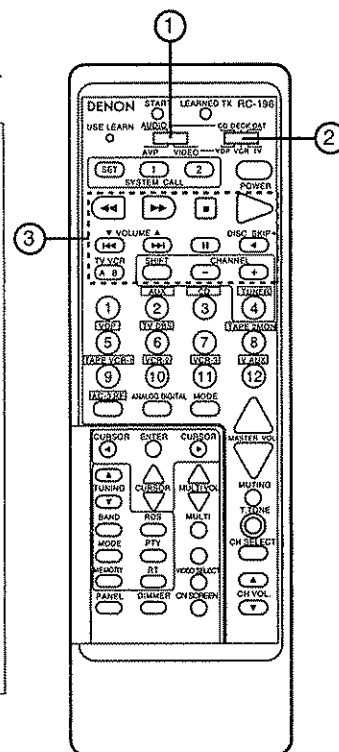
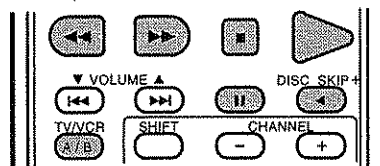

## 7-2 Preset memory

This remote control unit can be used to operate components of other manufacturers without using the learning function by registering the manufacturer of the component as shown on the diagrams below.

1. Set the slide switch to "VIDEO".



2. Set the slide switch to the component to be registered (VDP, VCR or TV).

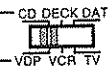

Ex.: To preset a VDP in the preset memory (Keep the POWER button pressed in when performing steps 3 and 4.)

3. Holding in the POWER button, press the button for the corresponding manufacturer in block A. (Refer to Table 1.)

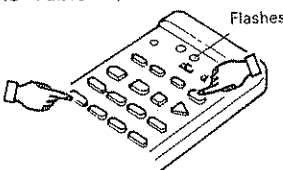

The LEARNED/TX LED flashes.

4. Next, while holding in the POWER button, press the button for the code in block B. (Refer to Table 1.) The operation is completed when the LEARNED/TX LED lights.

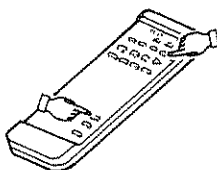

5. To continue registering other components, repeat steps 2 to 4.

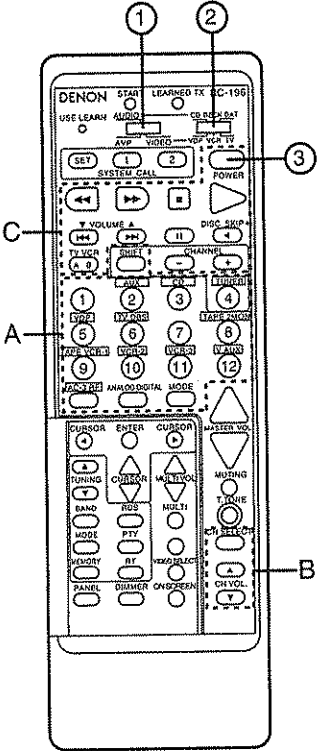

### ● Operation after components are registered

After components are registered, they can be operated using the buttons in block C shown below. For details, refer to the respective component's manual. Before operating the component, set slide switch ② to the position for that component.

#### 1. VDP

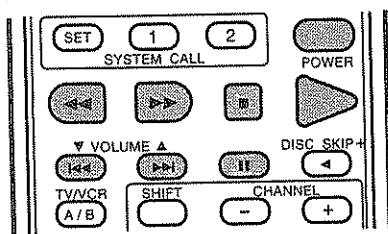

#### 2. VCR

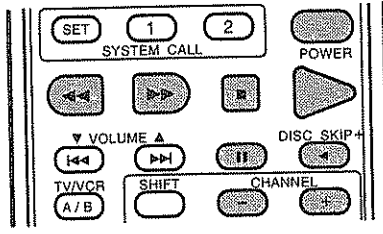

#### 3. TV

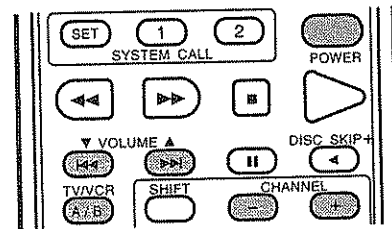

Table 1: Combinations of Personal System Codes for Different Manufacturers

"VDP"		CH SELECT	CH VOL. ▲	CH VOL. ▼
A	B			
1	DENON A	DENON B	DENON C	
2 (AUX)	—	—	—	
3 (CD)	MITSUBISHI	—	—	
4 (TUNER)	PANASONIC	—	—	
5 (VDP)	—	—	—	
6 (TV/DBS)	SONY A	SONY B	SONY C	
7	PIONEER	—	—	
8 (TAPE-2MON)	—	—	—	
9 (TAPE/VCR-1)	SANYO	—	—	
10 (VCR-2)	SHARP	—	—	
11 (VCR-3)	—	—	—	
12 (V.AUX)	PHILIPS	—	—	
AC-3RF	RCA	—	—	
ANALOG/ DIGITAL	—	—	—	
MODE	MAGNAVOX	—	—	

#### "VCR"

"VCR" <th>CH SELECT</th> <th>CH VOL. ▲</th> <th>CH VOL. ▼</th>		CH SELECT	CH VOL. ▲	CH VOL. ▼
A	B			
1	—	—	—	
2 (AUX)	HITACHI A	HITACHI B	HITACHI C	
3 (CD)	MITSUBISHI A	MITSUBISHI B	MITSUBISHI C	
4 (TUNER)	PANASONIC A	PANASONIC B	—	
5 (VDP)	JVC (VICTOR) A	JVC (VICTOR) B	—	
6 (TV/DBS)	SONY A	SONY B	SONY C	
7	PIONEER	—	—	
8 (TAPE-2MON)	TOSHIBA A	TOSHIBA B	—	
9 (TAPE/VCR-1)	SANYO A	SANYO B	—	
10 (VCR-2)	SHARP A	SHARP B	—	
11 (VCR-3)	NEC A	NEC B	NEC C	
12 (V.AUX)	PHILIPS A	PHILIPS B	PHILIPS C	
AC-3RF	RCA A	RCA B	—	
ANALOG/ DIGITAL	GENERAL ELECTRIC A	GENERAL ELECTRIC B	—	
MODE	MAGNAVOX A	MAGNAVOX B	MAGNAVOX C	

"TV"

A \ B	CH SELECT	CH VOL. ▲	CH VOL. ▼
1	DENON	—	—
2 (AUX)	HITACHI A	HITACHI B	—
3 (CD)	mitsubishi A	MITSUBISHI B	MITSUBISHI C
4 (TUNER)	PANASONIC	—	—
5 (VDP)	JVC (VICTOR)	—	—
6 (TV/DBS)	SONY	—	—
7	PIONEER	—	—
8 (TAPE-2MON)	TOSHIBA	—	—
9 (TAPE/VCR-1)	SANYO A	SANYO B	—
10 (VCR-2)	SHARP	—	—
11 (VCR-3)	NEC A	NEC B	NEC C
12 (V.AUX)	PHILIPS A	PHILIPS B	PHILIPS C
AC-3RF	RCA A	RCA B	—
ANALOG/ DIGITAL	GENERAL ELECTRIC A	GENERAL ELECTRIC B	—
MODE	MAGNAVOX A	MAGNAVOX B	MAGNAVOX C

**NOTE:**

Preset memory function will not work for some models or some codes. In such case, please use the learning function. (Page 20)

● Clearing the Preset Memory

1. Press the USE/LEARN selector button with the tip of a pen, etc., to set the learn mode.

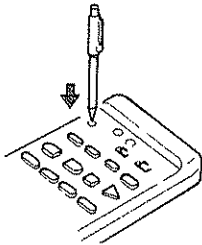

2. Set the slide switch to "VIDEO".

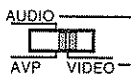

3. Set the program switch to the side to be cleared.



Ex.: To clear the VDP preset memory

4. Press the SYSTEM CALL SET button, and hold it in for at least four seconds.

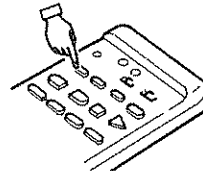

5. When both the START and LEARNED/TX LEDs light simultaneously, all the stored codes are cleared.

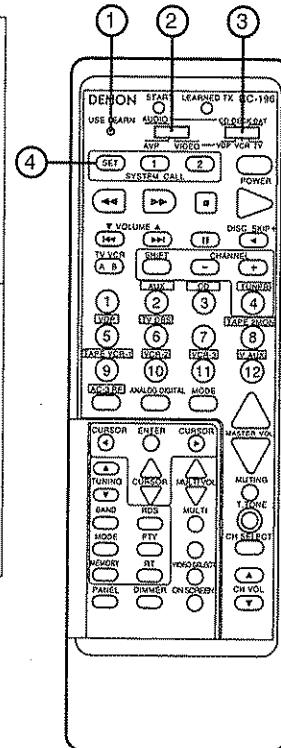
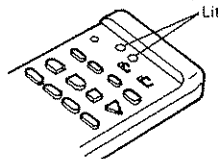

### 7-3 Remote Control Unit Learning Function

Use the learning function to operate audio components manufactured by companies other than Denon and when your VCR or TV does not operate with the preset memory function.

1. Press the USE/LEARN selector button with the tip of a pen etc., to set the learn mode. Both the START and LEARNED/TX indicators flash.

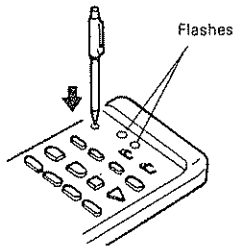

This unit's remote control unit

2. Set the program switch to the side to be "learned". Set to the AUDIO side for the CD, tape deck or DAT position, to the VIDEO side for the CDP, VCR or TV position.



3. Set the program switch to the position to be "learned".

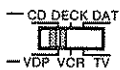

4. Set the remote control units so they are facing each other, then press the button to be "learned" on this unit's remote control unit.

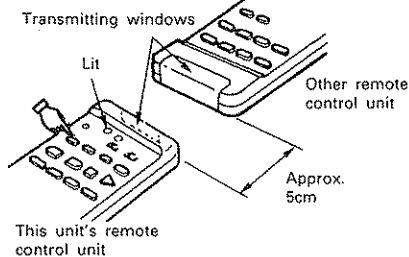

The indicator stops flashing and the START LED lights.

The learnable buttons are the buttons which can be operated with the DENON system codes for the CD player, DAT and tape deck, the buttons which can be operated with the preset memory for the VCR, VDP and TV. For the TV only, however, the buttons in the section indicated "A" on the diagram above can also be "learned". Use these to "learn" TV channels.

5. Check that the START LED is lit, then press the button to be "learned" on the other remote control unit.

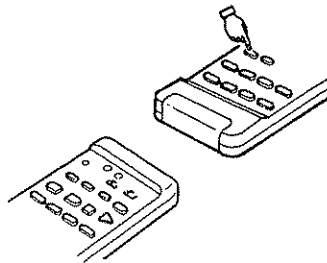

6. Once the START LED turns off and the LEARNED/TX LED lights, release the button on the other remote control unit.

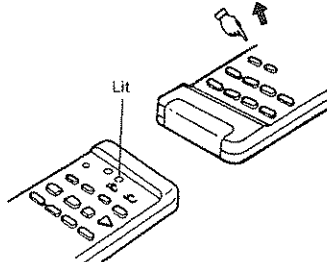

The two LEDs start flashing again.

7. To "learn" other buttons, repeat steps 2 to 6.

8. Once the learning operation is completed, press the USE/LEARN selector button again. The two LEDs stop flashing and the learning mode is cancelled.

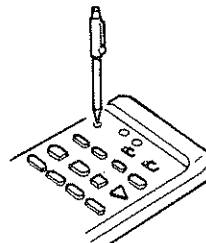

Check that the stored codes work properly.

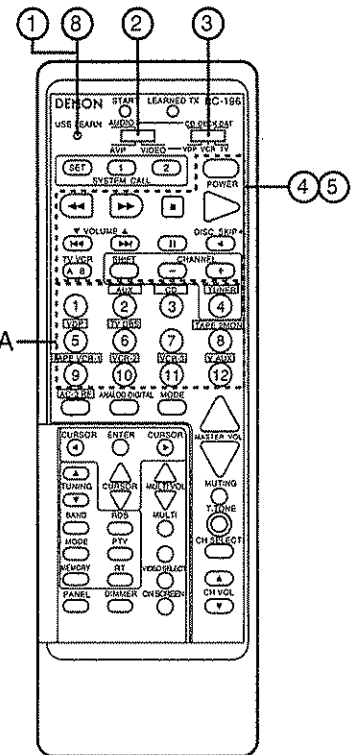

9. For instructions on resetting the "learned" codes, refer to "clearing the Pre-set Memory" on page 19.

#### NOTES:

- Up to 26 codes can be "learned", but this number may be lower if the codes are long.
- If a non-learnable button is pressed or two or more buttons are pressed at once, the two LEDs will once again light when the button(s) is released.
- If the codes could not be stored, the LEARNED/TX LED does not light after the START LED turns off. For limited number of models, codes cannot be stored in RC-196.
- If the two LEDs start flashing rapidly after the START LED lights, this means that the memory is already full, and the code you have just attempted to store was not stored. To "learn" that code, first perform the resetting operation.

## 8 OPERATIONS

### 8-1 Preparations for Play Back

1. Check that all connections are proper.
2. Set to the center position.

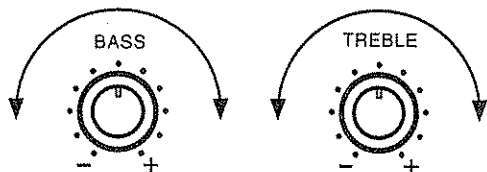

3. Set the remote control unit's slide switch to the AUDIO position.



4. Press the power button to turn the power on.

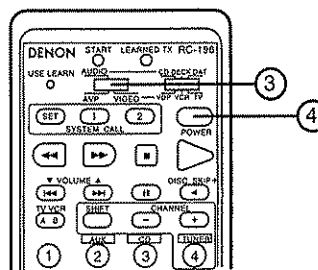
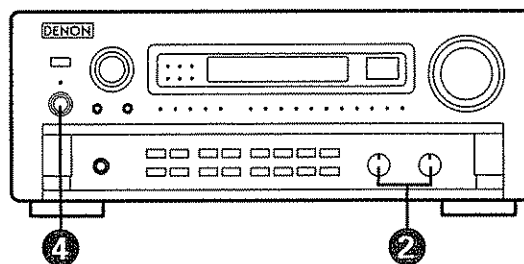
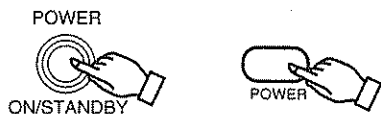

### 8-2 Playing the Analog program source (Stereo play back)

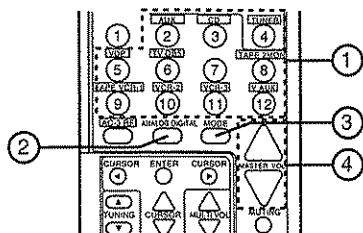
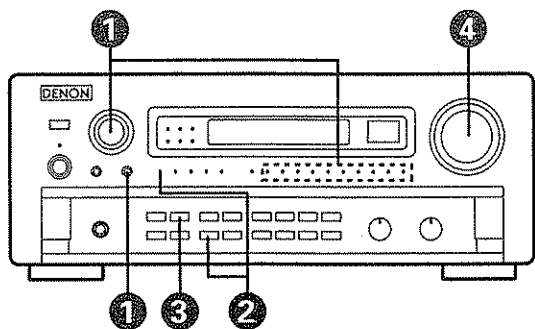

1. Select the source to be played.

INPUT SELECTOR



EX: CD input is selected.

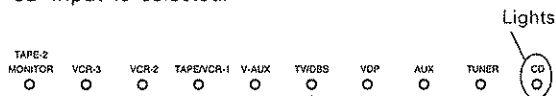

2. Select the ANALOG INPUT

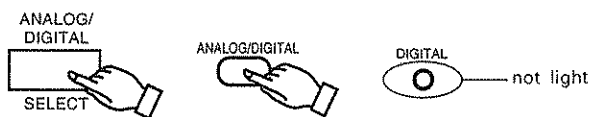

If "DIGITAL" indicator is lit, press the "ANALOG/DIGITAL" button.

3. Select the STEREO mode.



4. Adjust the MASTER VOLUME control.

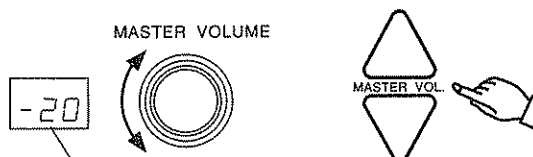

Volume level (-60 - 0 - 18) is displayed.

### 8-3 Playing the digital program source.

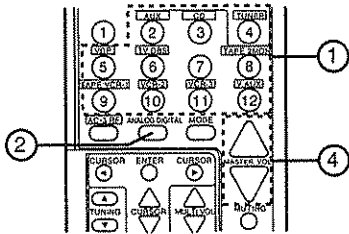
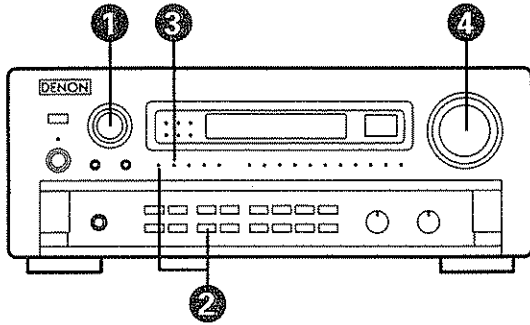

1. Select the program source connected to the digital input terminals you want to play.

INPUT SELECTOR



2. Select the digital input.

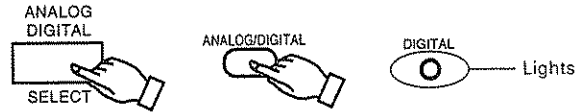

3. Check that the indicator showing that the digital input's program source can be played is lit.

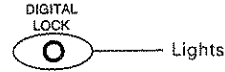

- ※ If the indicator is not lit, check that the system setup's input setting (refer to page 14, 15) and the connections are proper, that the component's power is turned on, etc.

4. Adjust the MASTER VOLUME control.

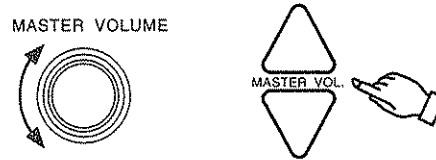

**NOTE:** If a CD-ROM is played, the DIGITAL LOCK LED turns on but no sound is heard.

### 8-4 Adjusting the TONE control

1. Adjust the BASS and TREBLE.

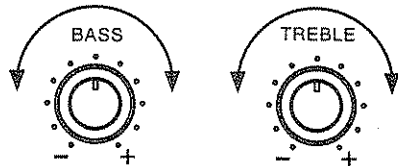

Turn the control clockwise to increase the bass or treble, counter-clockwise to decrease it.

2. DIRECT switch

Use this when you do not want to adjust the sound.

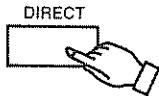

### 8-5 Simulcast playback

Use this switch to monitor a video source other than the audio source.

1. Press the VIDEO SELECT button repeatedly until the desired source appears on the display.

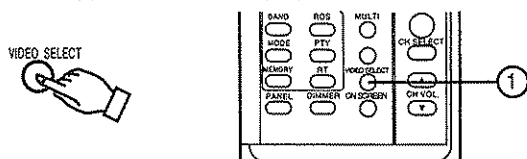

- ※ Cancelling simulcast playback.
- Select "SOURCE" using the video select button.
- Select the VIDEO & AC-3 RF function.

### 8-6 Using the muting function

Use this to turn off the audio output temporarily.

1. Press the MUTING button.

※ Cancelling MUTING mode.  
Press the MUTING button again.



## 8-7 Listen with headphones

Connect the headphones to the PHONES jack.  
The pre-out output is automatically turned off when headphones are connected.

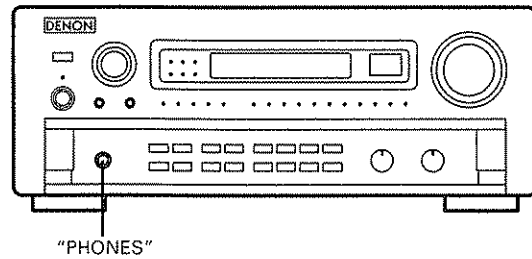

## 8-8 On-screen display

Each time an operation is performed, a description of that operation appears on the display connected to the unit's VIDEO MONITOR OUT terminal. Also, the unit's operating status can be checked during playback by pressing the remote control unit's ON SCREEN button.

Such information as the position of the input selector and the surround parameter settings is output in sequence.

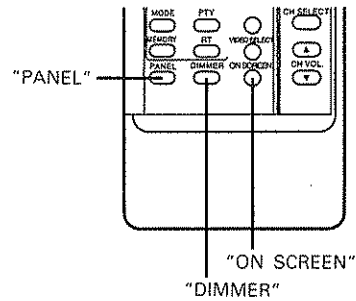

## 8-9 Front panel display

Descriptions of the unit's operations are also displayed on the front panel display. In addition, the display can be switched to check the unit's operating status while playing a source by pressing the remote control unit's PANEL button.

## 8-10 Using the dimmer function.

Use this to change the brightness of the display. The display brightness changes in four steps (bright, medium, dim and off) by pressing the remote control unit's DIMMER button.

## 8-11 Multi-Source REC OUT recording/playback

The Multi-Source/REC OUT function allows you to record a source other than the source currently playing or to output its signal to the MULTI SOURCE output terminal.

### ■ Recording a source other than the one currently playing (REC OUT mode)

1. Press the REC/MULTI MODE button  until "REC OUT SOURCE" appears on the display.

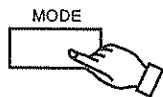

2. Select the source to be output to the recording output terminal. Press the REC/MULTI SOURCE button  repeatedly until the desired source appears on the display.

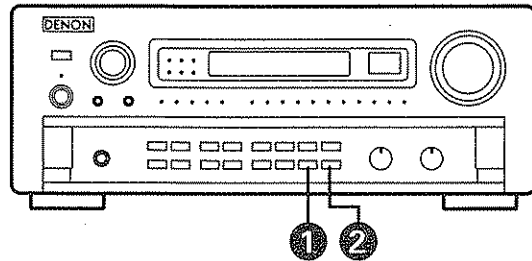
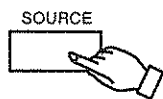

- ※ The signals of the source except the digital input selected with the REC OUT mode are also output from the MULTI SOURCE AUDIO/VIDEO OUT terminals.
- ※ Digital signals are only output from the recording output terminal after conversion into analog signals when playing the digital input in the stereo mode.
- ※ To cancel the REC OUT mode.  
Press the REC/MULTI MODE button or the REC/MULTI SOURCE button repeatedly until "SOURCE" appears on the display.

**■ Playing a source other than the one currently playing in a different room (MULTI mode)**

1. Press the REC/MULTI MODE  button repeatedly until "M-SOURCE SOURCE" appears on the display.

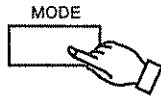

2. Select the source to be output to the MULTI SOURCE output terminal. Press the REC/MULTI SOURCE button  repeatedly until the desired source appears on the display.



- ※ When the MULTI button on the remote control unit is pressed, the source to be output from the MULTI SOURCE terminals can be selected. (This cannot be selected when the main unit is in the REC OUT mode.)
- ※ The digital signals are not output from the MULTI SOURCE AUDIO/VIDEO OUT terminals.
- ※ To cancel the MULTI mode Press the REC/MULTI MODE button or the MULTI button on the remote control unit repeatedly until "SOURCE" appears on the display.

3. The output level of the MULTI SOURCE AUDIO terminal can be controlled using the MULTI VOLUME UP and DOWN buttons  on the remote control unit.

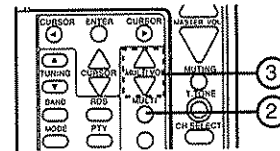
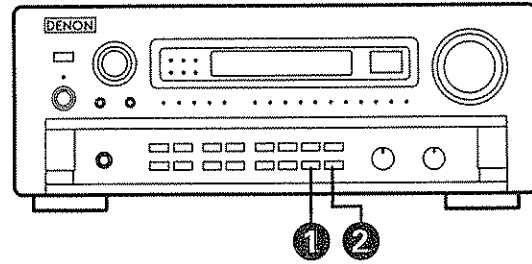

**NOTE:**

The signals of the source selected in the MULTI mode are also output from the TAPE and VCR recording output terminals.

**■ Multi-source and multi-zone playback**

**MULTI ROOM MUSIC ENTERTAINMENT SYSTEM**

- When the outputs of the MULTI SOURCE AUDIO/VIDEO OUT terminals are wired and connected to power amplifiers or TV displays installed in other rooms, different sources can be played in rooms other than the main room in which this unit and the playback devices are installed. (Refer to ANOTHER ROOM on the diagram of page 25.)
- When a separately sold room-to-room remote control unit (DENON RC-616, 617 or 618) is wired and connected between the main room and another room, the remote-controllable devices in the main room can be controlled from another room using the remote control unit.
- ※ To control playback devices other than the ones above, either use that device's remote control unit or preset a separately sold programmable remote control unit.

**NOTES:**

- Use a 75 Ω /ohms coaxial pin-plug cord for video signals to connect and wire the MULTI SOURCE VIDEO output. For the AUDIO output, use high quality pin-plug cords and wire in such a way that there is no humming or noise.
- For instructions on installation and operation of separately sold devices, refer to the devices' operating instructions.

**MULTI ROOM MUSIC ENTERTAINMENT SYSTEM**

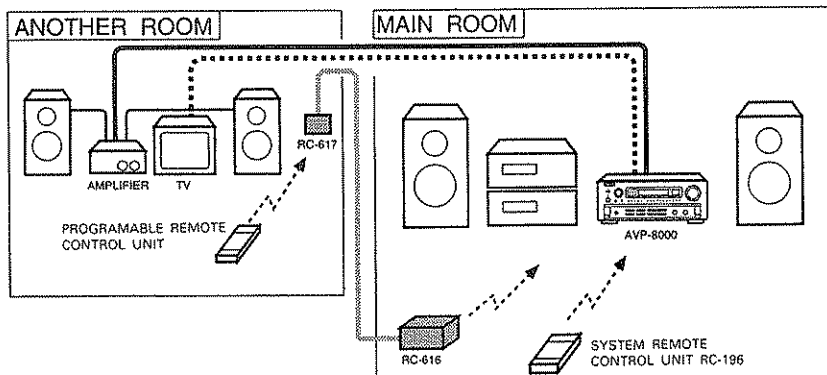

- ROOM-TO-ROOM REMOTE CONTROL SYSTEM (separately sold) control line
- MULTI SOURCE AUDIO signal cable
- ..... MULTI SOURCE VIDEO signal cable (75 Ω /ohms)
- SPEAKER cable

※ Refer to CONNECTIONS on pages 6 and 7.

## 8-12 System call (Remote control unit)

This functions allows you to preset frequently used operation patterns in the remote control unit then automatically send a series of up to ten remote control codes with a single button.

### Presetting

1. Press the SET button.



2. Press the buttons for the codes to be sent, changing the position of the slide switch as necessary. (Up to ten buttons can be set.)

Buttons which have been "learned" and buttons which have been preset can also be selected.

3. Press the SYSTEM CALL button ("1" or "2") at which you want to store the codes. The setting is now stored.

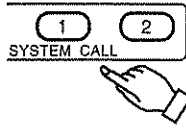

### Recalling

4. Press the SYSTEM CALL button ("1" or "2") at which the desired codes have been stored. The series of codes is now sent.

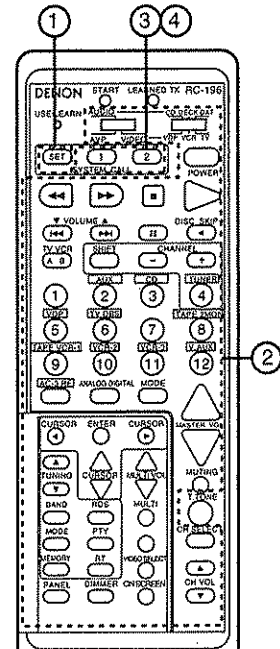
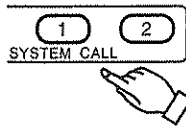

## 9 USING THE SURROUND FUNCTION

### 9-1 Dolby Surround & Home THX Cinema Surround

This unit is equipped with digital signal processing sections for decoding and reproducing movie soundtracks the same way as in movie theaters.

#### 9-1-1 Dolby Surround

##### 1. DOLBY SURROUND PRO LOGIC

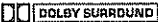
When using conventional video tapes, laser discs, TV programs or CDs with the  mark, Dolby Pro Logic provides extremely natural sound movement and positioning, immersing you in the on-screen action. Pro Logic uses a directional emphasis circuit to decode four output channels (front left and right, center and surround) from the two audio channels provided on the software.

##### 2. DOLBY SURROUND AC-3

When you connect an LD player with an AC-3 RF output and play laser discs with the  mark, you can experience improved sound spatiality, positioning, and impact compared with Pro Logic. This is because Dolby AC-3 delivers up to 5 totally discrete, full frequency audio channels (front left and right, center, and surround left and right), plus a bass-only effects channel. Since the signal is digital from the input of the program source until to the output of this unit, a higher quality and clarity of surround sound results.

Besides laser disc, this unit will also accept future digital formats with Dolby AC-3 such as SD Digital Video Discs and certain digital cable, satellite, and television broadcasts.

#### 9-1-2 HOME THX CINEMA surround

Use the Home THX Cinema mode along with the Dolby Surround processing described above to experience movie sound in your own listening room that matches what you would hear in the best movie theater or movie production studio. Use the Home THX Cinema mode for all movies on disc, tape, or television broadcast. For optimal multichannel sound performance, we recommend the use of THX power amplifiers (such as the DENON POA-8200 and POA-8300) and THX loudspeaker systems.

Manufactured under license from Dolby Laboratories Licensing Corporation. Additionally licensed under Canadian patent number 1,037,877. "Dolby," "AC-3", "Pro Logic," and the double-D symbol are trademarks of Dolby Laboratories Licensing Corporation.

Manufactured under license from Lucasfilm Ltd. U.S. patent numbers 5,043,970; 5,189,703; and 5,222,059. Foreign patents pending. Lucasfilm and THX are registered trademarks of Lucasfilm Ltd.

## 9-2 Using the Dolby Surround Pro Logic mode

1. Set the Dolby Surround mode.

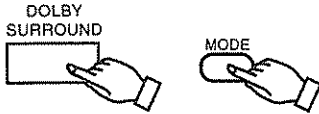

※ Conventional program sources will automatically be decoded with Dolby Pro Logic, while AC-3 program sources will be decoded with Dolby AC-3.

2. If necessary, adjust the input level when analog sources are used to obtain maximum dynamic range without overload. (screen 25)

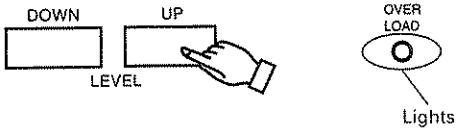

Set so that the indicator does not light at places where the volume is high.

- ※ For digital input sources, there is no need to adjust the input level. (These buttons will not operate and the indicator will not light.)
- ※ The current input source, input level, etc., can be checked on the on-screen display.

3. Play a program source with the or mark.

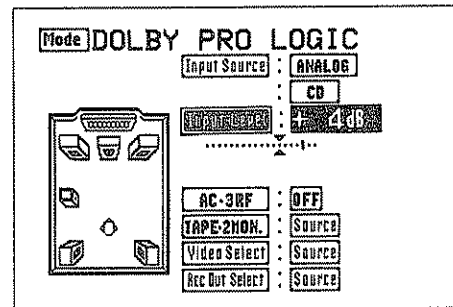
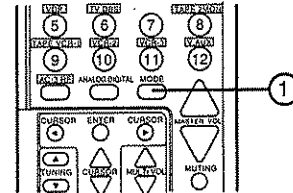
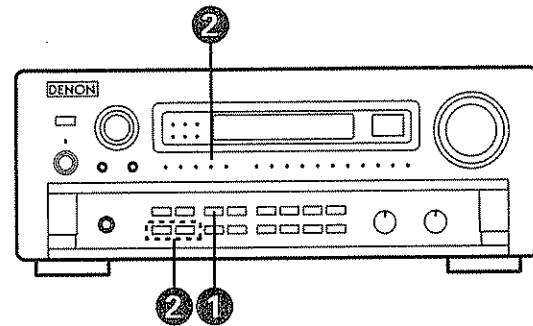

( screen 25 )

## 9-3 Using the Dolby Surround AC-3 mode

- 1a. AC-3 RF input

Select the AC-3 RF input program source.



- or
- 1b. Digital input

Select the digital input. Refer to page 22, 8-3, 1, 2 and 3.

2. Set the Dolby Surround mode.

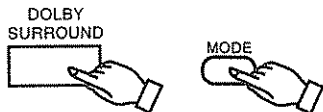

3. Play a program source with the mark or a program source with Dolby AC-3 digital formats. The indicators below showing the signals included in the software light. (The number of channels differs according to the software.)

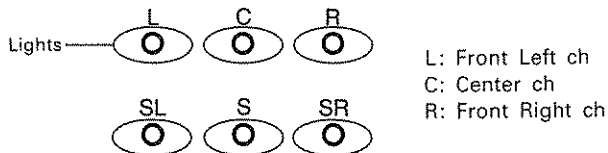

Also, the following indicator lights if the software contains low frequency effect sounds:

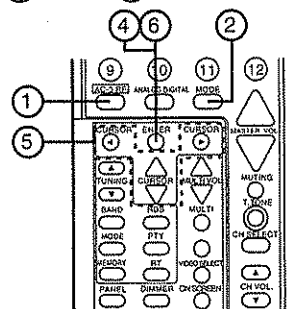
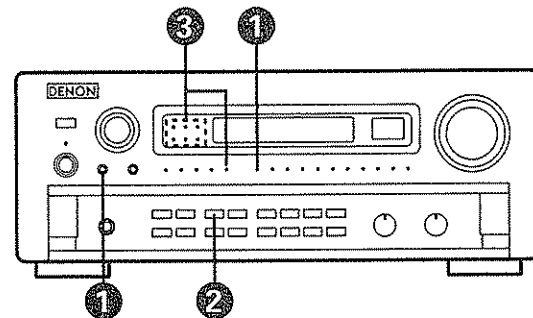
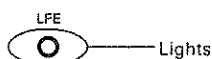

SL: Surround Left ch  
S: Mono Surround ch  
SR: Surround Right ch

4-1. Adjust the sound for the program source using the on-screen display.

4-2. Press the ENTER button.



4-3. Use the CURSOR buttons to specify "Surround Parameters", (screen 26)

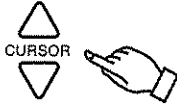

4-4. Press the ENTER button to switch the screen.

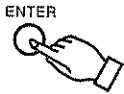

5. Use the CURSOR buttons to move the cursor on the screen and set the parameters. (screen 27)

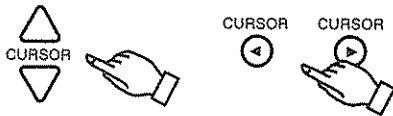

6. After the above settings are completed, press the ENTER button.

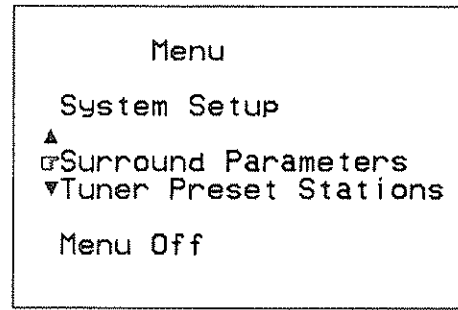

( screen 26 )

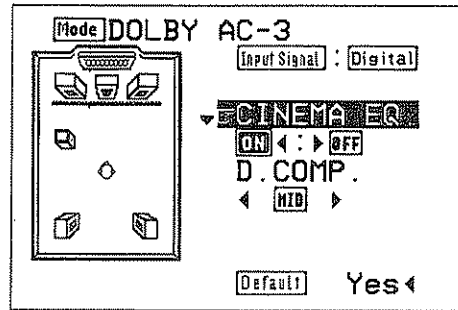

( screen 27 )

### ● Surround parameters

CINEMA ..... Use "CINEMA equalizer" if dialogues sound scratchy when playing movie software. (The higher frequency component is lowered.) (Only effective in the Dolby Pro Logic, Dolby AC-3 and WIDE SCREEN modes.)

D. COMP ..... "Dynamic Range Compression" compresses the dynamic range. This is only effective for Dolby AC-3 program sources. — There are four parameters: "OFF" ↔ "LOW" ↔ "MID" ↔ "HIGH"

**NOTE:** When "Default" is selected and the cursor button is pressed, "CINEMA EQ" and "D.COMP" are automatically set to "OFF".

### 9-4 Using the Home THX Cinema mode with Dolby Surround Pro Logic

1. Set the HOME THX CINEMA mode.

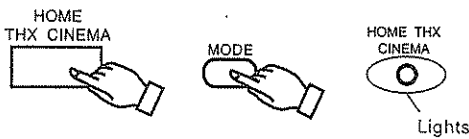

Select the HOME THX CINEMA mode for all movies on disc, tape, or television broadcast. The Home THX Cinema mode is activated simultaneously with either Dolby Surround Pro Logic or Dolby Surround AC-3. The THX processing will allow you to hear the sound as if you were in the best movie theater or movie production studio.

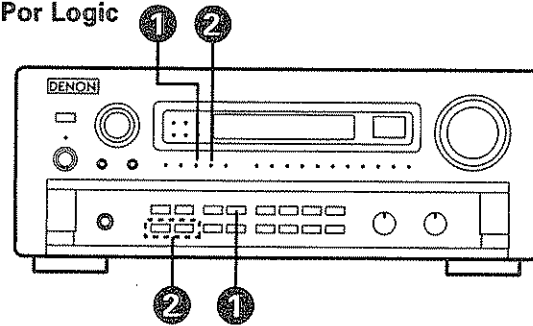

2. If necessary, adjust the input level when analog sources are used to obtain maximum dynamic range without overload. (screen 28)

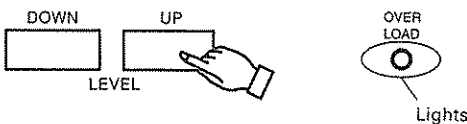

Set so that the indicator does not light at places where the volume is high.

※ For digital input sources, there is no need to adjust the input level. (These buttons will not operate and the indicator will not light.)

※ The current input source, input level, etc., can be checked on the on-screen display.

3. Play a program source with the or mark.

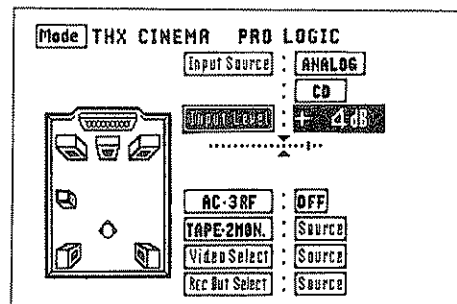
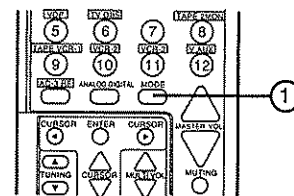

( screen 28 )

## 9-5 Using the Home THX Cinema mode with Dolby Surround AC-3

### 1a. AC-3 RF input

Select the AC-3 RF input program source.



or

### 1b. Digital input

Select the digital input. Refer to page 22, 8-3, 1, 2 and 3.

### 2. Set the Home THX Cinema mode.

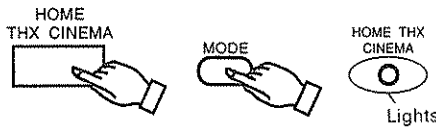

### 3. Play a program source with the mark or a program source with Dolby AC-3 digital formats.

The indicators below showing the signals included in the software light. (The number of channels differs according to the software.)

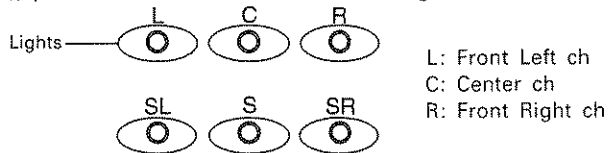

Also, the following indicator lights if the software contains low frequency effect sounds:

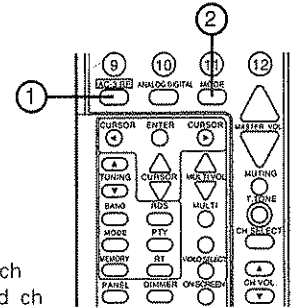
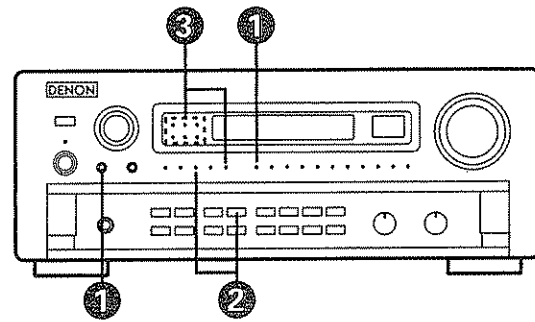
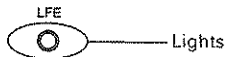

## 9-6 DSP surround simulation

This unit is equipped with a high precision D.S.P. (Digital Signal Processor) for processing signals digitally to simulate sound fields. Select the surround mode according to the playback source and adjust the parameters according to the conditions in the listening room to achieve a realistic, powerful sound.

These surround modes can be used with program sources not recorded in Dolby surround except wide screen mode.

### Types of surround modes and their characteristics

1	Wide Screen	Use this to enjoy program sources, with the atmosphere of a movie theater. This mode is suited for program sources recorded in Dolby surround or Dolby AC-3.
2	Mono	Use this when playing monaural signals, for example AM broadcasts or news programs.
3	5ch Stereo	The signals of the left and right channels are distributed to the different speakers to achieve a stereo sound from all directions at the listening position.
4	Super Stadium	Use this to enjoy program sources such as football or baseball games with the atmosphere of a stadium.
5	Rock Arena	The powerful reverberations of this mode produce a sound field which recreates the excitement of live concerts. This mode is effective for rock, popular music, etc.
6	Jazz Club	This mode creates the sound field of a live house with a low ceiling and hard reverberations. The result is that the artist seems to be performing right before your eyes.
7	Classic Concert	This mode creates a sound field simulating a large concert hall, rich in reverberation. This mode is characterized by composed acoustics, and is perfect for playing classical music, etc.
8	Matrix	Use this to enjoy stereo music sources with rich reverberations.

### Personal Memory Plus function .... for EASY TO USE

This unit automatically stores the surround mode adding effects for all input sources. The corresponding surround mode is recalled automatically each time an input source is selected.

## 9-7 Using the DSP surround simulation

1. Select the surround mode according to the input source.

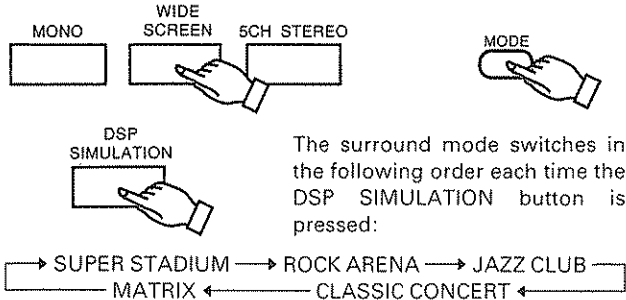

2. Press the ENTER button and call out the "Menu" screen from the on-screen display.



3. Use the CURSOR buttons to specify "Surround Parameters". (screen 29)

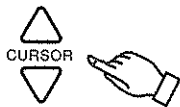

4. Press the ENTER button. The screen switches.

5. Move the cursor on the screen and make the various settings. (screen 30)

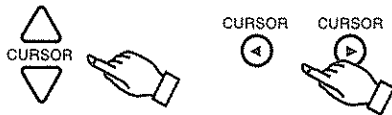

6. After the above settings are completed, press the ENTER button.

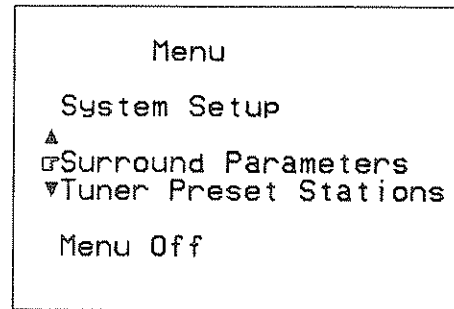
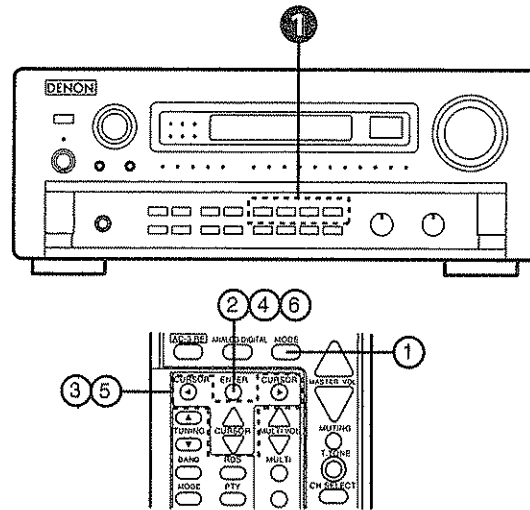

( screen 29 )

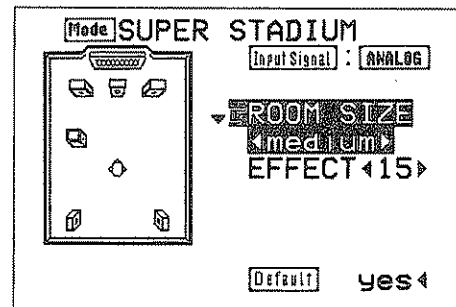

( screen 30 )

### ● Surround modes and parameters

- CINEMA ..... Use "CINEMA equalizer" if dialogues sound scratchy when playing movie software. (The higher frequency component is lowered.) (Only effective in the Dolby Pro Logic, Dolby AC-3 and WIDE SCREEN modes.)
- ROOM SIZE ..... "Room size" refers to the size of the sound field. — There are five parameters: "Small" ↔ "med.S." ↔ "medium" ↔ "med.L." ↔ "large"
- EFFECT LEVEL ..... "Effect level" refers to the strength of the effect sounds. If the sound is distorted or seems strange, lower the level. Parameter "1" ~ "15"
- DELAY ..... This can be set to between 0 and 360 msec for the MATRIX mode.
- D. COMP ..... "Dynamic Range Compression" compresses the dynamic range. This is only effective for Dolby AC-3 program sources. — There are four parameters: "OFF" ↔ "LOW" ↔ "MID" ↔ "HIGH"

**NOTE:** When "Default" is selected and the cursor button is pressed, "CINEMA EQ" and "D.COMP" are automatically set to "OFF", "ROOM-SIZE" is set to "medium", "EFFECT LEVEL" is set to "10" and "DELAY TIME" is set to "30 ms".

## 10 LISTENING TO THE RADIO

### 10-1 Auto tuning

1. Set the input function to "TUNER".

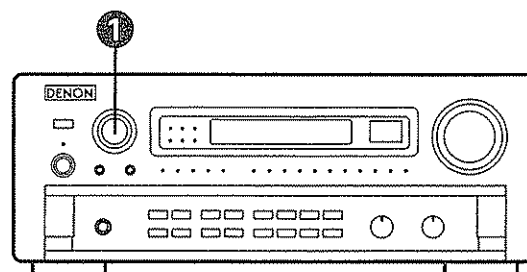
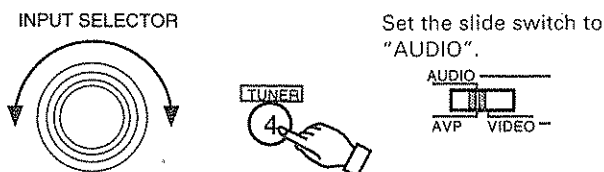

- Watching the display, press the BAND button to select the desired band (AM or FM).



- Press the MODE button to set the auto tuning mode.
- Press the TUNING UP or DOWN button.

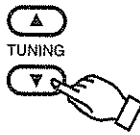
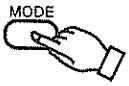

"AUTO" appears on the FL display.

Automatic searching begins, then stops when a station is tuned in.

If tuning does not stop at the desired station, use the "Manual tuning" operation.

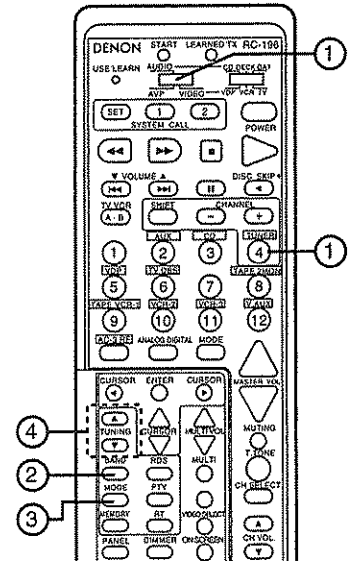

### 10-2 Manual tuning

- Set the input function to "TUNER".
- Watching the display, press the BAND button to select the desired band (AM or FM).
- Press the MODE button to set the manual tuning mode. Check that the FL display's "AUTO" indicator turns.

- Press the TUNING UP or DOWN button to tune in the desired station. The frequency changes continuously when the button is held in.

#### NOTES:

- When in the auto tuning mode on the FM band, the "STEREO" indicator lights on the FL display when a stereo broadcast is tuned in. At open frequencies, the noise is muted and the "TUNED" and "STEREO" indicators turn off.
- When the manual tuning mode is set, FM stereo broadcasts are received in monaural and the "STEREO" indicator turns off.

### 10-3 Preset memory

- Use the "Auto tuning" or "Manual tuning" operation to tune in the station to be preset in the memory.
- Press the MEMORY button.



- Press the SHIFT button and select the desired memory block (A to D).

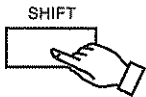

- Press the PRESET UP or DOWN button to select the desired preset channel (1 to 8).

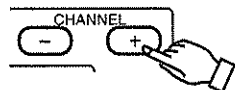
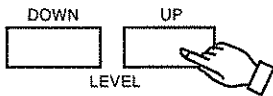

- Press the MEMORY button again to store the station in the preset memory.

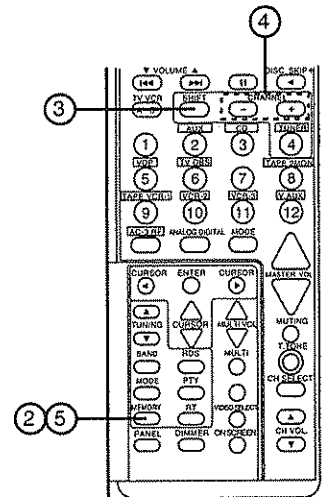
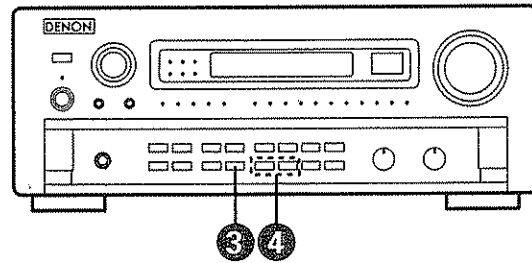
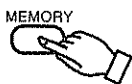

To preset other channels, repeat steps 2 to 5. A total of 32 broadcast stations can be preset — 8 stations (channels 1 to 8) in each of blocks A to D.

### 10-4 Checking the preset stations

The preset broadcast stations can be checked on the on-screen display.

1. Press the ENTER button repeatedly until the "Tuner Preset Stations" screen appears on the on-screen display. (screen 29)

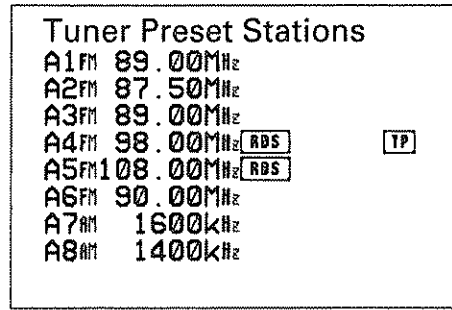
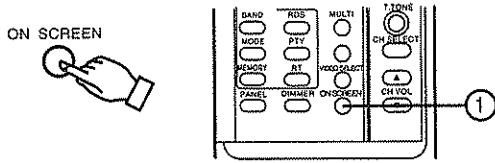

( screen 31 )

### 10-5 Recalling preset stations

1. Watching the display, press the SHIFT button to select the preset memory block.

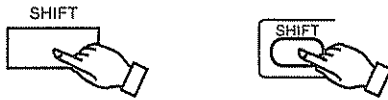

2. Watching the display, press the PRESET UP or DOWN button to select the desired preset channel.

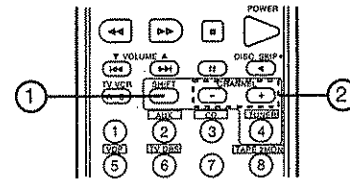
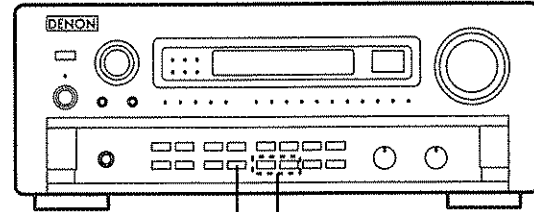

### 10-6 Recalling preset stations with the on-screen display

1. Press the ENTER button and call out the "Menu" screen from the on-screen display.



2. Use the CURSOR buttons to specify "Tuner Preset Stations". (screen 32)

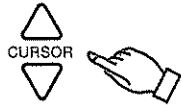

3. Press the ENTER button. The screen switches to the "Tuner Preset Stations" screen. (screen 33)



4. Use the CURSOR buttons to select the station you want to tune in. (screen 33)



Use the right CURSOR to select between memory blocks A, B, C and D.

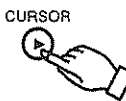

5. Once the desired station is selected, press the left cursor button to actually tune it in.

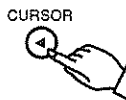

6. Once the desired station is tuned in, press the ENTER button. The menu screen is displayed.

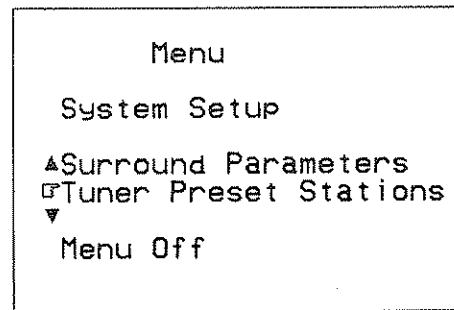

( screen 32 )

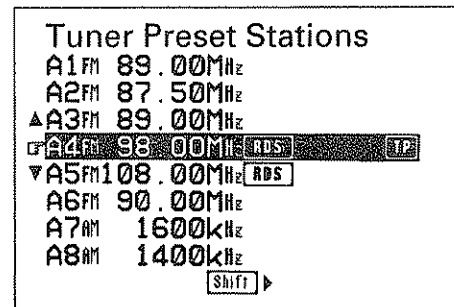

( screen 33 )

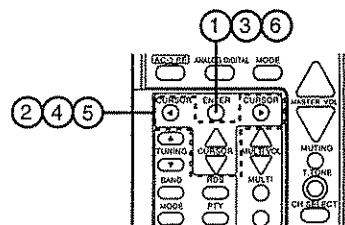

## 10-7 RDS (Radio Data System)

RDS (works only on the FM band) is a broadcasting service which allows station to send additional information along with the regular radio program signal.

The following three types of RDS information can be received on this unit:

### • Program Type (PTY)

PTY identifies the type of RDS program.

The program types and their displays are as follows:

NEWS	News	TOP 40	Top 40	SOFT R&B	Soft R & B
INFORM	Information	COUNTRY	Country	LANGUAGE	Language
SPORTS	Sports	OLDIES	Oldies	REL MUSC	Religious Music
TALK	Talk	SOFT	Soft	REL TALK	Religious Talk
ROCK	Rock	NOSTALGA	Nostalgia	PERSNLTY	Personality
CLS ROCK	Classic Rock	JAZZ	Jazz	PUBLIC	Public
ADLT HIT	Adult Hits	CLASSICL	Classical		
SOFT RCK	Soft Rock	R & B	R & B		

### • Traffic Program (TP)

TP identifies programs that carry traffic announcements.

This allows you to easily find out the latest traffic conditions in your area before you leaving home.

### • Radio Text (RT)

RT allows the RDS station to send text messages that appear on the display.

## 10-8 RDS search

Use this function to automatically tune to FM stations that provide RDS service.

1. Set the input function to "TUNER".

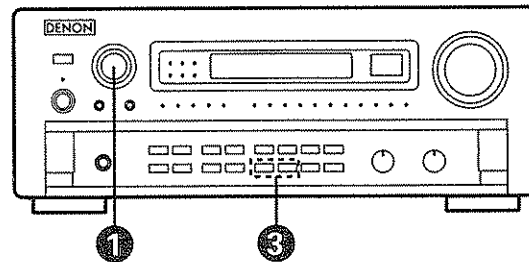
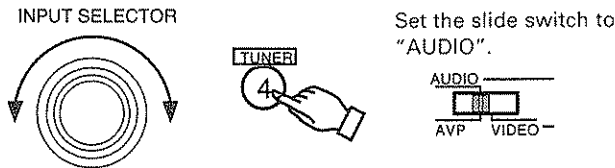

2. Press the RDS button until "RDS SEARCH" appears on the display.

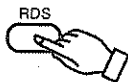

3. Press the PRESET UP or DOWN button to automatically begin the RDS search operation.



4. When a broadcast station is found, that station's name appears on the display.

5. To continue searching, repeat step 3. If no other RDS station is found when all the frequencies are searched, "NO RDS" is displayed.

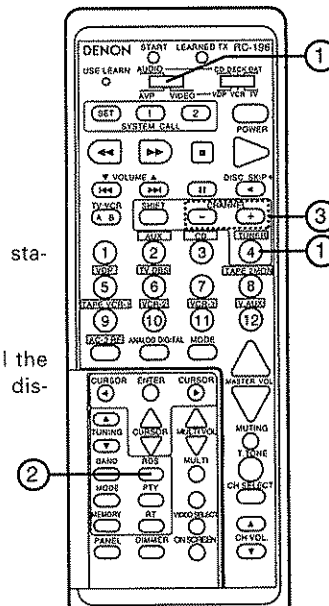

If no RDS stations is found with above operation, all the respection band are searched.

### 10-9 PTY search

Use this function to find RDS stations broadcasting a designated program type (PTY).  
For a description of each program type, refer to "Program Type (PTY)".

1. Set the input function to "TUNER".

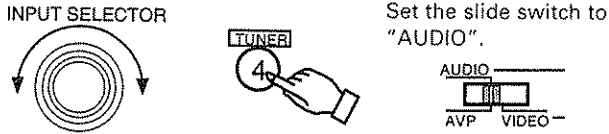

2. Press the RDS button until "PTY SEARCH" appears on the display.

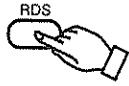

3. Watching the display, press the PTY button to call out the desired program type.

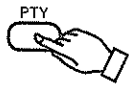

4. Press the PRESET UP or DOWN button to automatically begin the PTY search operation.



If there is no station broadcasting the designated program type with above operation, all the reception bands are searched.

5. The station name is displayed on the display after searching stops.
6. To continue searching, repeat step 4.  
If no other station broadcasting the designated program type is found when all the frequencies are searched, "NO PROGRAMME" is displayed.

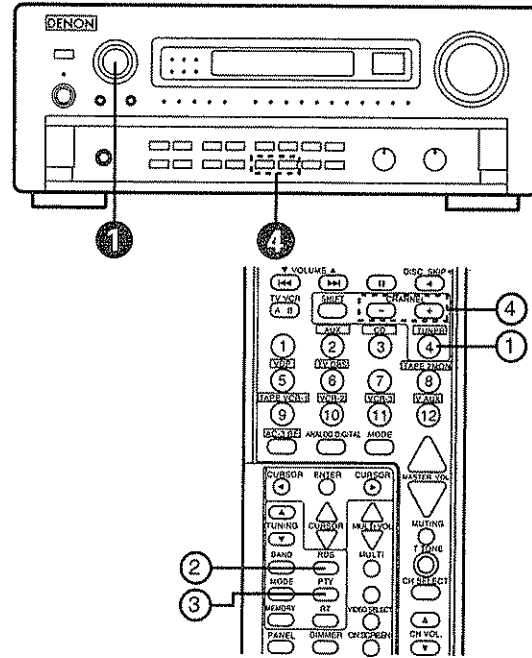

### 10-10 TP search

Use this function to find RDS stations broadcasting traffic program (TP stations).

1. Set the input function to "TUNER".

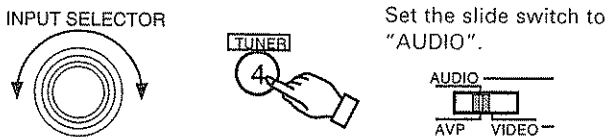

2. Press the RDS button until "TP SEARCH" appears on the display.

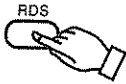

3. Press the PRESET UP or DOWN button TP search begins.



If no TP station is found with above operation, all the reception bands are searched.

4. The station name is displayed after searching stops.
5. To continue searching, repeat step 3.  
If no other TP station is found when all the frequencies are searched, "NO PROGRAMME" is displayed.

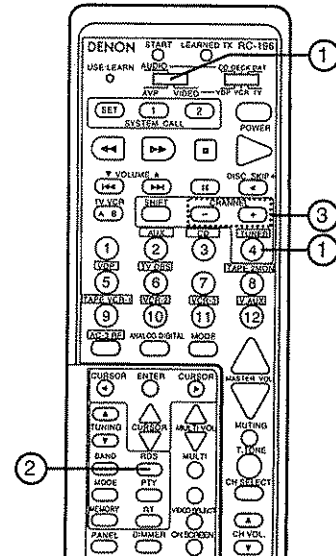
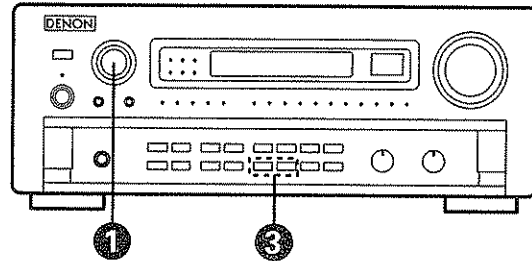

## 10-11 RT (Radio Text)

"RT" appears on the display when radio text data is received. When the RT button is pressed while receiving an RDS broadcast station, the text data broadcast from the station is displayed. To turn the display off, press the RT button again. If no text data is being broadcast, "NO TEXT DATA" is displayed.

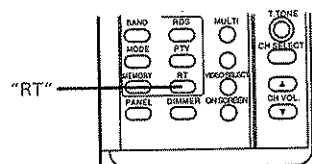

### • RDS Emergency Alert

"ALERT" will flash on the MFD when the unit receives the Emergency Program Type Code (PTY31) from an RDS station. This feature may not operate properly if the signal from the RDS station is too weak or is subjected to interference. It is not possible to select the "ALERT" display from the PTY search mode.

#### RDS Emergency Alert Feature

The RDS Emergency Alert Feature is activated by a signal sent at the sole discretion of the RDS broadcaster. The RDS Emergency Alert Feature is included in this product for the convenience of the consumer, and is not intended to augment or replace the Official Emergency Broadcast System as administered by the Federal Communications Commission. For this reason, Nippon Columbia Co. and its Subsidiaries, including but not limited to DENON ELECTRONICS a division of DENON Corporation (USA) and DENON Canada, Inc., refuse all Warranties, claims of merchantability or fitness, or liabilities, whether incidental, consequential or otherwise, related to, either directly or indirectly, the operation or lack of operation of this feature. This exclusion applies to any and/or all Nippon Columbia co. Products, whether present or future, that implement, in any form or variation, the RDS Emergency Alert Feature.

## 11 LAST FUNCTION MEMORY

- This unit is equipped with a last function memory which stores the input and output setting conditions as they were immediately before the power is switched off. This function eliminates the need to perform complicated resettings when the power is switched on.
- This unit is also equipped with a back-up memory. This function provides approximately one week of memory storage with the power cord disconnected.

## 12 INITIALIZATION OF THE MICROPROCESSOR

When the indication of the FL display is not normal or when the operation of the unit does not show the reasonable result, the initialization of the microprocessor is required by the following procedure.

1. Switch off the unit and remove the AC power cord from the wall outlet.
2. Hold the following AC-3 RF button and TAPE-2 MONITOR button, and plug the power cord into the outlet.
3. Check that the entire display is flashing with an interval of about 1 second, and release your fingers from the 2 buttons.
4. Switch on the unit and the microprocessor will be initialized.

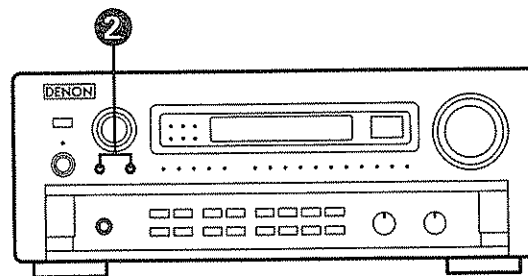

## 13 TROUBLESHOOTING

If a problem should arise, first check the following:

1. Are the connections correct?
2. Have you operated the amplifier according to the Operating Instructions?
3. Are the speakers, turntable, and other components operating properly?

If this unit is not operating properly, check the items listed in the table below. Should the problem persist, there may be a malfunction. Disconnect the power immediately and contact your store of purchase.

	Symptom	Cause	Measures	Page
During listening to CDs, tapes, or FM radio	DISPLAY does not light and no sound is produced when POWER switch turned on.	<ul style="list-style-type: none"> <li>• Power cord not plugged in securely.</li> </ul>	<ul style="list-style-type: none"> <li>• Check that power cord is plugged in securely.</li> </ul>	6~9
	DISPLAY lights but no sound is produced.	<ul style="list-style-type: none"> <li>• Incomplete speaker cord connections.</li> <li>• Input selector not set at proper position.</li> <li>• Volume control turned to minimum.</li> <li>• Muting is on.</li> <li>• Digital signals not input Digital input selected.</li> </ul>	<ul style="list-style-type: none"> <li>• Connect securely.</li> <li>• Set to proper position.</li> <li>• Turn up to an appropriate level.</li> <li>• Press remote control unit MUTING button to turn muting off.</li> <li>• Input digital signals or select input jacks to which digital signals are being input.</li> </ul>	6~9 21,22 21,22 22 22
	No sound produced from one side.	<ul style="list-style-type: none"> <li>• Incomplete speaker cord connections.</li> <li>• Incomplete input/output cord connections.</li> </ul>	<ul style="list-style-type: none"> <li>• Connect securely.</li> <li>• Connect securely.</li> </ul>	9 6~9
	Position of instruments reversed for stereo mode.	<ul style="list-style-type: none"> <li>• Left and right speakers or left and right input/output cords connected inversely.</li> </ul>	<ul style="list-style-type: none"> <li>• Check left/right connections.</li> </ul>	6~9
Remote control unit	Receiver does not operate properly when remote control unit is used.	<ul style="list-style-type: none"> <li>• Batteries dead.</li> </ul>	<ul style="list-style-type: none"> <li>• Replace with new batteries.</li> </ul>	17
		<ul style="list-style-type: none"> <li>• Remote control unit too far from receiver.</li> </ul>	<ul style="list-style-type: none"> <li>• Move closer.</li> </ul>	17
		<ul style="list-style-type: none"> <li>• Obstacle between receiver and remote control unit.</li> </ul>	<ul style="list-style-type: none"> <li>• Remove obstacle.</li> </ul>	17
		<ul style="list-style-type: none"> <li>• Different button is being pressed.</li> <li>• ⊕ and ⊖ ends of battery inserted in reverse.</li> </ul>	<ul style="list-style-type: none"> <li>• Press the proper button.</li> <li>• Insert batteries properly.</li> </ul>	17

## 14 SPECIFICATIONS

- **Audio section**

- (Analog)

Input sensitivity/input impedance:	200 mV/47 k $\Omega$ /kohms
Frequency response:	10 Hz ~ 100 kHz: +0, -3 dB (DIRECT mode)
S/N	105 dB (DIRECT mode)
Distortion:	0.005% (20 Hz ~ 20 kHz) (DIRECT mode)
Rated output / maximum output:	1.2 V/8 V
Maximum headphones output:	284 mW (8 $\Omega$ /ohms)

- (Digital)

D/A output:	Rated output - 2 V (at 0 dB playback) Total harmonic distortion - 0.005% (1 kHz, at 0 dB) S/N ratio - 102 dB Dynamic range - 96 dB
Digital input:	Format - Digital audio interface

- **Video section**

- (Standard video jacks)

Input/output level and impedance:	1 Vp-p, 75 $\Omega$ /ohms
Frequency response:	5 Hz ~ 10 MHz +0, -3 dB

- (S-video jacks)

Input/output level and impedance:	Y (brightness) signal - 1 Vp-p, 75 $\Omega$ /ohms C (color) signal - 0.286 Vp-p, 75 $\Omega$ /ohms
Frequency response;	5 Hz ~ 10 MHz +0, -3 dB

- **Tuner Section**

	[FM] (note: $\mu$ V at 75 $\Omega$ /ohms, 0 dBf = $1 \times 10^{-15}$ W)	[AM]
Receiving Range:	87.5 MHz ~ 107.9 MHz	520 kHz ~ 1710 kHz
Usable Sensitivity:	1.0 $\mu$ V (11.2 dBf)	18 $\mu$ V
50 dB Quieting Sensitivity:	MONO 1.6 $\mu$ V (15.3 dBf) STEREO 23 $\mu$ V (38.5 dBf)	
Signal to Noise Ratio (IHF-A):	MONO 80 dB STEREO 75 dB	50 dB
Total Harmonic Distortion (at 1 kHz):	MONO 0.15% STEREO 0.3%	

- **General**

Power supply:	AC 120 V, 60 Hz
Power consumption:	60 W
Maximum external dimensions:	434 (W) $\times$ 167 (H) $\times$ 396 (D) mm (17-3/32" $\times$ 6-37/64" $\times$ 15-19/32")
Weight:	13.5 kg (29 lbs 13 oz)

- **Remote control unit (RC-196)**

Batteries:	R6P/AA Type (two batteries)
External dimensions:	70 (W) $\times$ 215 (H) $\times$ 19 (D) mm (2-3/4" $\times$ 8-15/32" $\times$ 3/4")
Weight:	180 g (Approx. 6 oz) (including batteries)

### NIPPON COLUMBIA CO., LTD.

14-14, AKASAKA 4-CHOME, MINATO-KU, TOKYO 107-11, JAPAN  
Telephone: (03) 3584-8111  
Cable: NIPPON COLUMBIA TOKYO Telex: JAPANOLA J22591