

HANDBOOK OF INSTRUCTIONS



marantz.



model eighteen

Stereophonic Receiver

GENERAL DESCRIPTION

With the exception of the CRT*, the Model Eighteen is an all transistor receiver, based on the same advanced circuits used in the Marantz Model 10B Tuner, 7T Solid State Preamplifier, and 15 Solid State Power Amplifier. Its circuitry includes 73 transistors and 76 diodes, a total of 149 solid-state devices. A tuner, preamplifier, and power amplifier make up the three basic components mounted on a single chassis and sharing a common power supply. Internal connections between these components have been designed to provide optimum performance from each component while retaining the full flexibility of separate units. The extraordinary flexibility of the Eighteen allows the connection of two pairs of loudspeakers, headphones, a turntable **and** record changer, an additional tuner (such as AM/FM), a TV sound source, and two tape recorders for record, playback and tape copying functions. Its flexibility will allow other connections to be made for special applications. Its performance is the equal of the finest separate component system of comparable power.

* Cathode Ray Tube (Also referred to as oscilloscope or "scope.")

table of contents

FOREWORD	1	OPERATION	7
AFTER UNPACKING	1	SIMPLIFIED OPERATING PROCEDURE	7
WARRANTY	1	CRT INDICATOR	8
CABINET INSTALLATION	1	Centering of the CRT Display	8
PREPARATION FOR USE	3	FM Tuning Display	8
REAR SIGNAL CONNECTIONS	3	Adjusting Antenna Direction	9
Phonograph	3	PUSHBUTTON SWITCHES	9
Tape Input	3	Phono 2 Switch	9
Auxiliary	3	Mono (L+R) Switch	10
Tape Recording Output	3	Tape Monitor Switch	10
Loudspeaker Systems	5	Audio Display Switch	10
FM Antenna	6	Hi Blend Switch	11
POWER CONNECTIONS	7	Lo Filter Switch	12
Line Cord	7	Hi Filter Switch	12
Convenience Outlet	7	Muting Off Switch	12

table of contents

MAIN CONTROLS	12	Recording a Long-Duration Program	15
Selector	12	Copying and Editing	15
Balance	13	Modifying a Tape Copy	17
Volume	13	TECHNICAL DESCRIPTION	18
Bass and Treble	13	GENERAL	18
Speaker Systems Switch	13	FUNCTIONAL DESCRIPTION	19
FRONT PANEL JACKS	13	TECHNICAL SPECIFICATIONS	24
Dubbing Out	13	SERVICE NOTES	26
Dubbing In	13	Fuse	26
Stereophones	13	Knobs	26
SOME SUGGESTIONS ON USING TAPE RECORDERS		Cleaning	26
WITH YOUR MODEL EIGHTEEN	15	Repairs	26
Recording and Playback	15	Replacing Dial-Glass Lamps	26
Making Two Tape Recordings Simultaneously	15	Re-Stringing Dial Cord	27

list of illustrations

FIGURE NO.	TITLE	PAGE
1	Rear Panel Connection Facilities	2
2	Loudspeaker Systems Connections	4
3	FM Antenna Connection	6
4	CRT Centering	8
5	Tuning Display	8
6	FM Broadcast Modulation Characteristics	9
7	Adjusting Antenna Direction	10
8	Audio Display	11
9	Front Panel Controls, Jacks, and Display CRT	12
10	Stereo Phone Plug	13
11	Arrangement of Two Tape Recorders with Model Eighteen	14
12	Arrangement for Making Modified Tape Copies	16
13	Functional Block Diagram	18
14	Phono Equalization Characteristics	20
15	Tone Control Characteristics	21
16	Low and High Filter Characteristics	22
17	Dial-Stringing Diagram	27
18	Packing Instructions	28

FOREWORD

To obtain maximum performance and enjoyment from your Eighteen Stereo Receiver, please study these instructions carefully. Installation and operation of the Eighteen is not complicated, but the extraordinary flexibility provided by its numerous features may not be fully appreciated unless you spend a little time becoming familiar with its controls and connection facilities.

For your convenience, this manual is divided into two parts. The first part covers installation and operation in a simple, non-technical manner. The second part provides a more detailed description of the features and facilities of your Eighteen. It has been written to answer the question "What goes on inside?", and to help you in situations where you may wish to use the Eighteen in special applications. Detailed technical specifications are also included in this part.

For quick identification of the many controls, and connection facilities on the Eighteen Stereo Receiver, all references to them in this manual are printed in **bold-face** type. You will notice that the spelling, capitalization, abbreviation, and punctuation of all such markings appear exactly as lettered on the front and rear panels of the instrument.

AFTER UNPACKING

It will be to your advantage to save all the packing materials—carton, fillers, cushioning, etc. They will prove valuable in preventing damage should you ever have occasion to transport or ship your Eighteen. (Refer to Figure 18 for packing instructions.)

Be careful that you do not inadvertently throw away or lose the **PARTS KIT** envelope packed with the unit. This envelope contains

spare parts, mounting screws for custom installations; and an Allen hex-socket wrench for removing front panel knobs. If you are not using the Eighteen in a custom-panel installation, we suggest that you store your **PARTS KIT** envelope in a safe place, unopened, because the contents will not be necessary for installation.

Please inspect your Eighteen carefully for any signs of damage incurred in transit. It has undergone very strict quality-control inspection and tests prior to packing; thus it left the factory in perfect operating condition. If you should discover damage, notify the transportation company without delay. Only you, the consignee, may institute a claim with the carrier for damage during shipment, however, the Marantz Company will cooperate fully with you in such an event. Save the carton as evidence of damage for their inspection.

WARRANTY

To qualify for the Marantz 3-Year Golden Warranty, please fill out the warranty registration card and mail it to the factory promptly. Your warranty protection will not go into effect unless you promptly return the registration card, which is packed within the carton.

CABINET INSTALLATION

The Marantz Model Eighteen Stereo Receiver can be installed in furniture cabinets and custom-built panels, or it can be used on an open shelf or table-top. An attractive, solidly constructed, oiled walnut cabinet—the Model B18-O—may be ordered from your dealer. Installing the Eighteen into this cabinet is easily accomplished after removing the feet from the receiver and sliding it into the cabinet, then fastening it in place with the screws supplied with the cabinet. For custom installations, refer to the **MOUNTING TEMPLATE** diagram supplied with this unit.

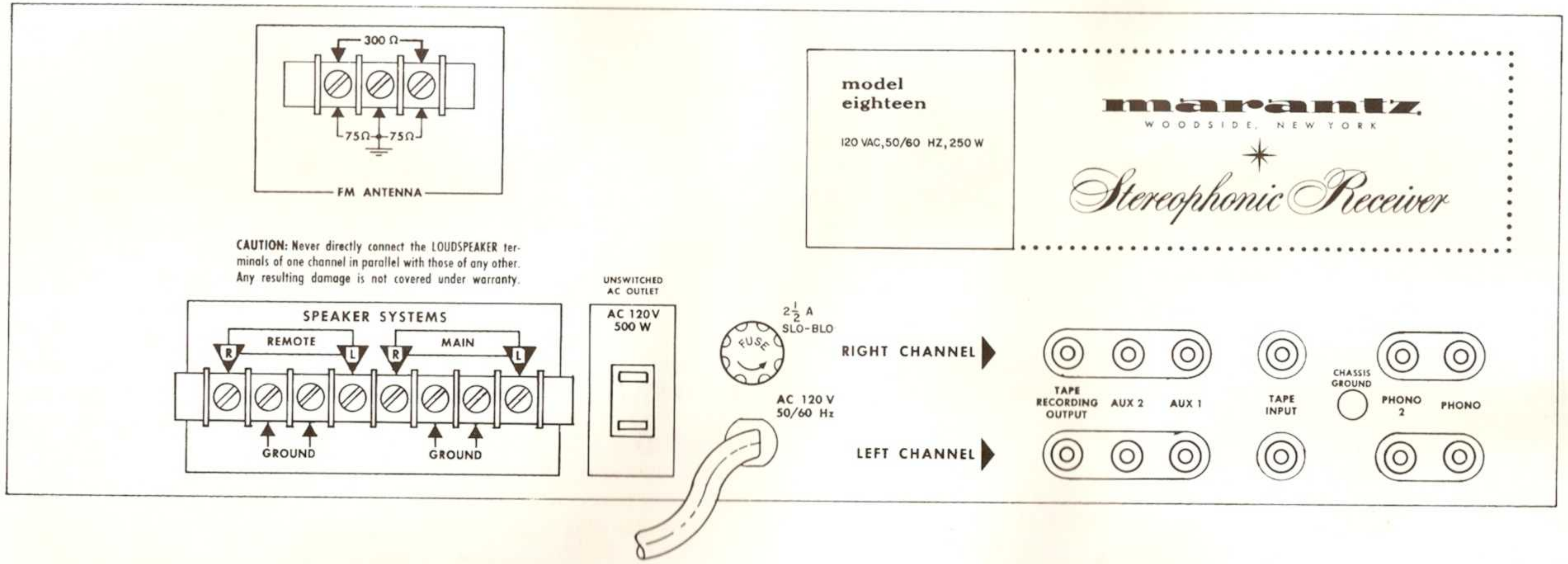

Figure 1. Rear Panel Connection Facilities

PREPARATION FOR USE

REAR SIGNAL CONNECTIONS

All signal connections to the Eighteen, with the exception of the FM antenna and loudspeakers, should be made with shielded audio cables. Figure 1 shows the location of the input and output jacks on the rear panel. These jacks are for "permanent" connections. Use of the front panel jacks will be discussed later. The rear panel signal connections are arranged in stereo pairs. To avoid confusion, we suggest that you connect one cable at a time between the Eighteen and the other components of your system. In this way, you will avoid mixing up the channels or mixing up signal sources and destinations. Notice in Figure 1, that the two pairs of jacks at the lower right corner of the rear panel are for low-level **PHONO**graph input signals; the next three pairs of jacks to the left are for high-level input signals.

PHONO and PHONO 2 jacks These jacks are intended for use with standard phono cartridges requiring a standard 47,000 ohm resistive load.

If hum is heard when playing records, it is evidence of inadequate grounding or shielding of record player or connections. Try reversing the polarity of the turntable's power plug. If this is inadequate or ineffective, connect a separate ground wire from the turntable or record changer frame to the **CHASSIS GROUND** binding post on the Eighteen. If the tone-arm is mounted on a wood panel or is otherwise insulated from the frame, connect the tone-arm's mounting base to the grounding wire with a short jumper. If the two pairs of signal wires in the arm have a single, overall shield, try grounding the shield instead of the arm itself. Keep the two phono connecting cables and the grounding wire close together. In three-wire (common ground) systems, this will minimize "ground loops".

TAPE INPUT jacks This pair of jacks serves two purposes:

1. With the selector switch in **TAPE** position, signals from a tape recorder can be played through your system when the recorder is set for playback mode of operation. This configuration permits playing tape sources stereophonically or monophonically (determined by position of **Mono (L+R)** pushbutton switch).

2. With the selector switch in any other position, and the **Tape Monitor** pushbutton switch depressed, taping quality can be "monitored" when the recorder is set in the recording mode of operation (assuming of course, that the recorder is equipped with separate record and playback heads and separate record and playback preamplifiers).

AUX 1 and AUX 2 jacks These high-level input jacks have been provided for connecting miscellaneous sources such as: extra tape players (with self-contained playback preamplifiers); phono cartridges which provide RIAA-equalized high-level output; additional tuners or receivers; TV sound outputs, etc.

TAPE RECORDING OUTPUT jacks Connecting these jacks to the line or "radio" inputs of your tape recorder permits you to record any program source material (as indicated by position of selector switch).

The signals available at this pair of jacks are unaffected by the **balance, volume, treble, bass, Lo Filter, and Hi Filter** controls on the front panel. They are, however, controlled by the **Mono (L+R)** and **Hi Blend** pushbutton switches.

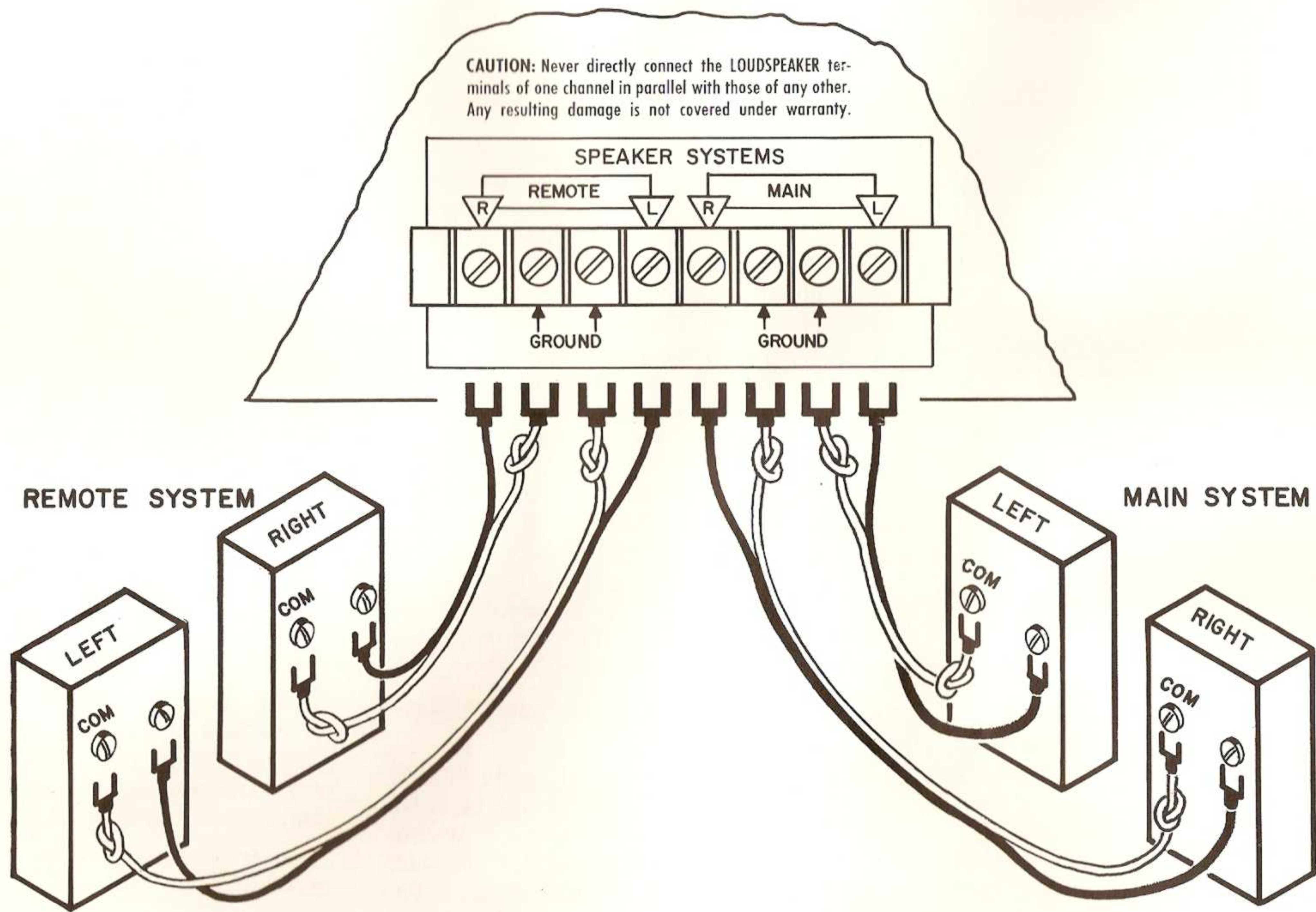

Figure 2. Loudspeaker Systems Connections

LOUDSPEAKER SYSTEMS

The **SPEAKER SYSTEMS** terminals on the left side of the rear panel will accommodate two (pairs of) loudspeaker systems, each having a rated impedance between 4 and 16 ohms. When using only one pair of loudspeakers, connect them to the terminals marked **MAIN**. The terminals marked **REMOTE** are used for connecting a second pair of loudspeakers in another room away from the Model Eighteen.

Selection of loudspeaker systems is made by the **speaker systems** switch on the front panel.

Be careful in connecting the Model Eighteen to a loudspeaker which contains a built-in power supply—such as an electrostatic loudspeaker. The “common” speaker-connection terminal of these devices may be capacitively grounded through the power supply. Make sure the **GROUND** terminals of the Model Eighteen are connected to the “common” terminals of the loudspeaker system.

Ordinary #18-gauge, two conductor lamp cord (“zipcord”) may be used for normal distances (to about 30 feet) between the amplifier and the loudspeaker. For longer lengths, use #16-gauge wire or heavier, depending on distance.

In connecting two loudspeakers for stereo

operation, it is important to insure correct relative phasing (polarity). This is best achieved, when using identical loudspeakers, by simply coding each wire for identification. One wire in each pair should be coded at both ends with a knot, tape, etc. The coded wires can then be used for identical connections in each channel. For example, the **coded wire** in each pair can be connected to the “common” terminal of each loudspeaker and the **GROUND** terminal of each amplifier channel. The uncoded wire of each pair is then connected to the remaining loudspeaker terminal and the remaining terminal on each amplifier channel (**L** and **R**). This procedure insures correct polarity or phasing of identical loudspeakers.

NOTE

Close inspection of standard zipcord will reveal some form of coding on the insulation (ridge or groove on one edge); or one of the wires may be tinned and the other wire not tinned.

If there is any doubt about phasing of your loudspeakers for stereo operation, particularly if they are **not** identical, a simple listening test can be performed to verify correct phasing. With program signals fed to both channels of the unit, and the **Mono (L+R)** pushbutton switch depressed, the sound should appear to originate at a point midway between the loudspeakers, when the **balance** control is centered. As the **balance** control

is turned away from the center position, the sound source should appear to move toward one of the loudspeakers.

In some situations, undesirable “room acoustics” can make the results of this test ambiguous or confusing. Under such difficult circumstances, temporarily move the loudspeakers as close together as possible, (and if possible, facing each other) and, with the controls set for balanced **Mono (L+R)** operation, listen to program material which contains strong bass passages. Reverse the wires to **one** of the loudspeakers and listen to the same passages again. If there is noticeably less bass with the reversed-wires connection, change the wire connections back to the original arrangement. If there is noticeably more bass, leave the wires connected in reverse.

It is important to note that one or both of the previous phasing procedures should be used with **each** pair of loudspeakers, whether they are the **MAIN** or **REMOTE** speaker systems. If both pairs of loudspeakers are used in the same listening area, check to insure that the **MAIN** pair is also “in-phase” with the **REMOTE** pair.

CAUTION

Never directly connect the loudspeaker terminals of one channel in parallel with those of any other. Any resulting damage is not covered under warranty.

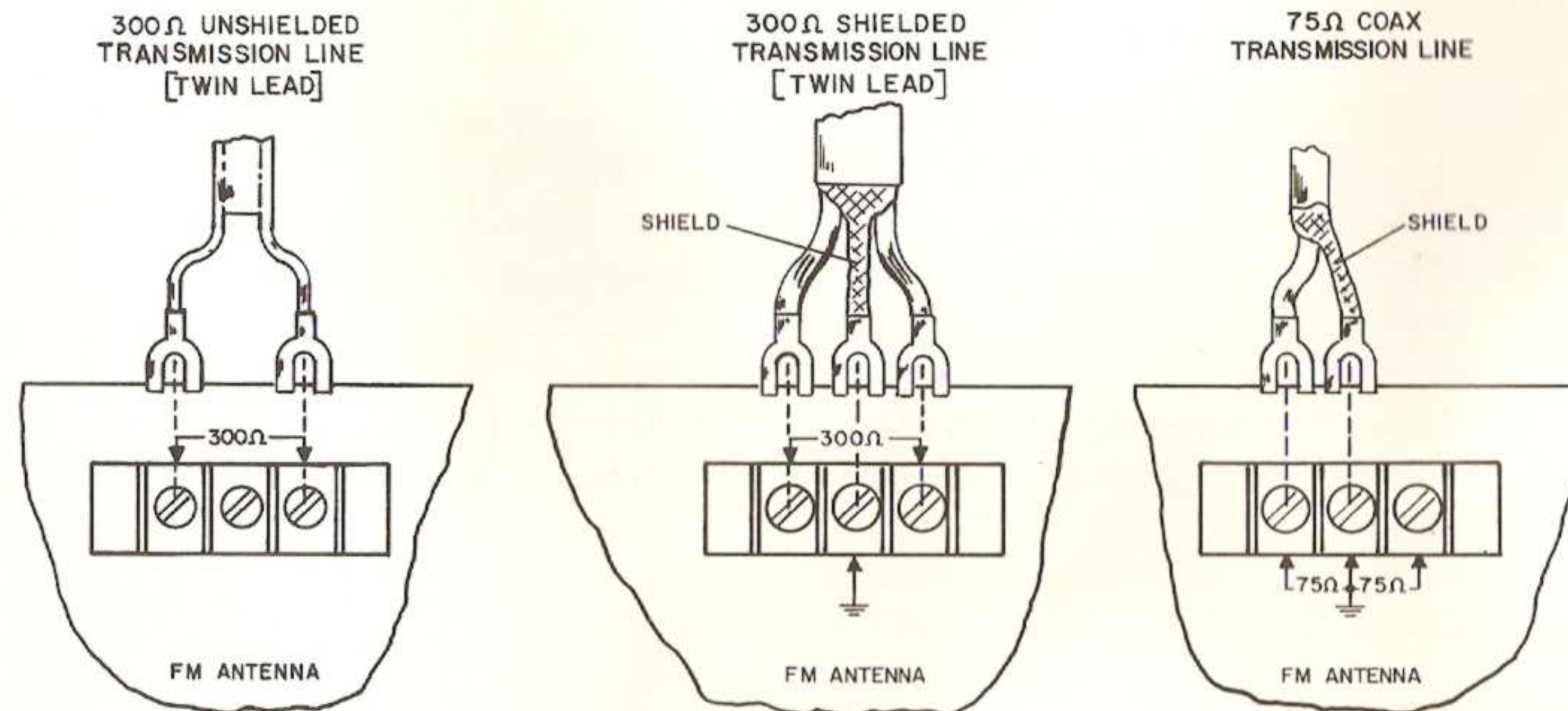

Figure 3. FM Antenna Connection

FM ANTENNA

The best FM reception can be obtained with a "log-Periodic" type antenna, used in conjunction with a good quality rotor system. In fringe areas, it is recommended that a "Log-Periodic" antenna be used which has six or more elements and has been designed expressly for FM reception. For the greatest immunity from local noise and multipath pickup by the lead-in wire, a balanced and shielded 300-ohm cable should be used. (Because an unshielded lead-in wire acts as an omni-directional antenna, its pickup can cancel the directional characteristics of your antenna.) Low-loss 300-ohm shielded cables are manufactured by Belden, ITT-Federal, Columbia Wire, and other companies. These cables consist of two inner conductors plus an outer shield and insulating jacket. This type

of shielded cable effectively prevents the lead-in from contributing multi-path distortion.

In rural areas, it is recommended that you consult with a local dealer concerning antenna installation and lightning arrestor protection. Master antenna systems are not recommended for use with your Model Eighteen. Master antenna systems are usually designed expressly for television reception and may frequently use 88-108 MHz (FM) filters to suppress FM signals before distribution. In addition, master antenna towers are fixed installations with no facilities for rotation. Master antenna systems, at best, severely limit good-quality FM reception.

Where outdoor antennas are prohibited, or unsuitable for high-quality FM reception, the simplest form of 300-ohm TV (or preferably

FM) "rabbit-ear" antenna is the most practical and will give satisfactory results in primary signal areas. This type is preferred over a ribbon-type folded dipole because it can more readily be rotated for best reception. The Model Eighteen Receiver will accept either a 75-ohm or a 300-ohm antenna cable. Refer to the appropriate connection diagram in Figure 3. Connection of signal leads of all 300-ohm antenna cables is made between the outer terminals of the FM ANTENNA terminal block. The center terminal is **GROUND** and is provided for the connection of the antenna shield (when shielded cable is used). Connection of a 75-ohm antenna cable is made between the center terminal and either of the outer terminals. Be sure to connect the shield of the 75-ohm cable to the center terminal (**GROUND**).

POWER CONNECTIONS

Line Cord With the **POWER ON-OFF** switch on the front panel set to **OFF**, plug the line cord into an electrical outlet providing 105 to 125 volts, 50 to 60 Hz, **AC ONLY**.

Convenience Outlet

An **UNSWITCHED AC OUTLET** on the rear panel has been provided for powering an associated component for your system, such as a tape recorder, record player, etc.

This **AC OUTLET** is not controlled by the **POWER ON-OFF** switch, and is intended for powering an associated component having its own On-Off switch.

OPERATION

NOTE

The Model Eighteen Receiver is equipped with an electronic time delay circuit which mutes the signal to the loudspeakers for 4 to 6 seconds after the receiver is turned-on. The display cathode ray tube will require additional warm-up time (about 30 seconds after the receiver is turned-on) before the trace becomes visible.

SIMPLIFIED OPERATING PROCEDURE

If you are operating the Model Eighteen Stereo Receiver for the first time, follow

these simple directions. Later on, you can take full advantage of the instrument's unusual versatility by learning to use the remaining controls and pushbuttons.

- Step 1.** Check that all pushbutton selectors are in the "out" position. Pushbutton switches which have been depressed should be pushed in and released to the "out" position.
- Step 2.** Turn the **volume** control all the way to the left (fully counter-clockwise) and set the **balance** control to mid-position (pointer to dot).
- Step 3.** Rotate **treble** and **bass** controls to the "straight up" position (each pair of pointers to dot).
- Step 4.** Set **speaker systems** switch to **MAIN** position (assuming, of course, that the loudspeakers have been connected to the **MAIN** amplifier terminals).
- Step 5.** Turn on system power with the **POWER ON-OFF** switch.

Step 6. Set the display **CENTERING** controls (at the left of the CRT) to the "straight up" position.

Step 7 Select the desired program source by turning the **selector** switch to the appropriate position. If FM is selected, rotate the "Gyro-Touch" **TUNING** knob until the desired station is tuned. Turn the **volume** control to provide a comfortable listening volume.

The tuner section of the Model Eighteen is equipped with electronically triggered photoelectric circuits which automatically mute interstation noise and automatically switch to the proper mode of operation for stereo and monophonic FM broadcasts. In addition, the **STEREO** indicator light turns on in the presence of a stereo broadcast. These "light switches" have **no** moving parts and produce **no** mechanical or electrical noise during switching.

The display "scope" is equipped with an automatic dimming circuit which extends the life of the cathode ray tube, and reduces the possibility of accidentally burning the screen phosphors. This dimming action will be observed when the trace reduces to a "dot" (low or no signal level).

CRT INDICATOR

Centering of the CRT Display When the centering controls are rotated, both the tuning display and the audio display will move vertically and horizontally. To correctly set these controls, do the following:

- Step 1.** Depress the **Tape Monitor** pushbutton switch and the **Audio Display** pushbutton switch. Note that the "scope" trace will be reduced to a "dot" (if connected, your tape recorder should be turned off during this adjustment). Under high ambient light conditions and/or low power line conditions, the "dot" may appear extremely dim. If necessary, shade the "scope" so that the "dot" appears brighter during adjustment.
- Step 2.** Adjust the **CENTERING** controls to bring the dot into the center of the small circle (as illustrated in Figure 4).
- Step 3.** Release the **Tape Monitor** and **Audio Display** pushbutton switches. The tuning display and audio display are now both centered correctly.

FM TUNING DISPLAY

When the **Audio Display** pushbutton is "out", note that as you tune past each station a bright trace appears in the tuning indicator. This trace follows an approximately rectangular path as it is tuned. To be properly

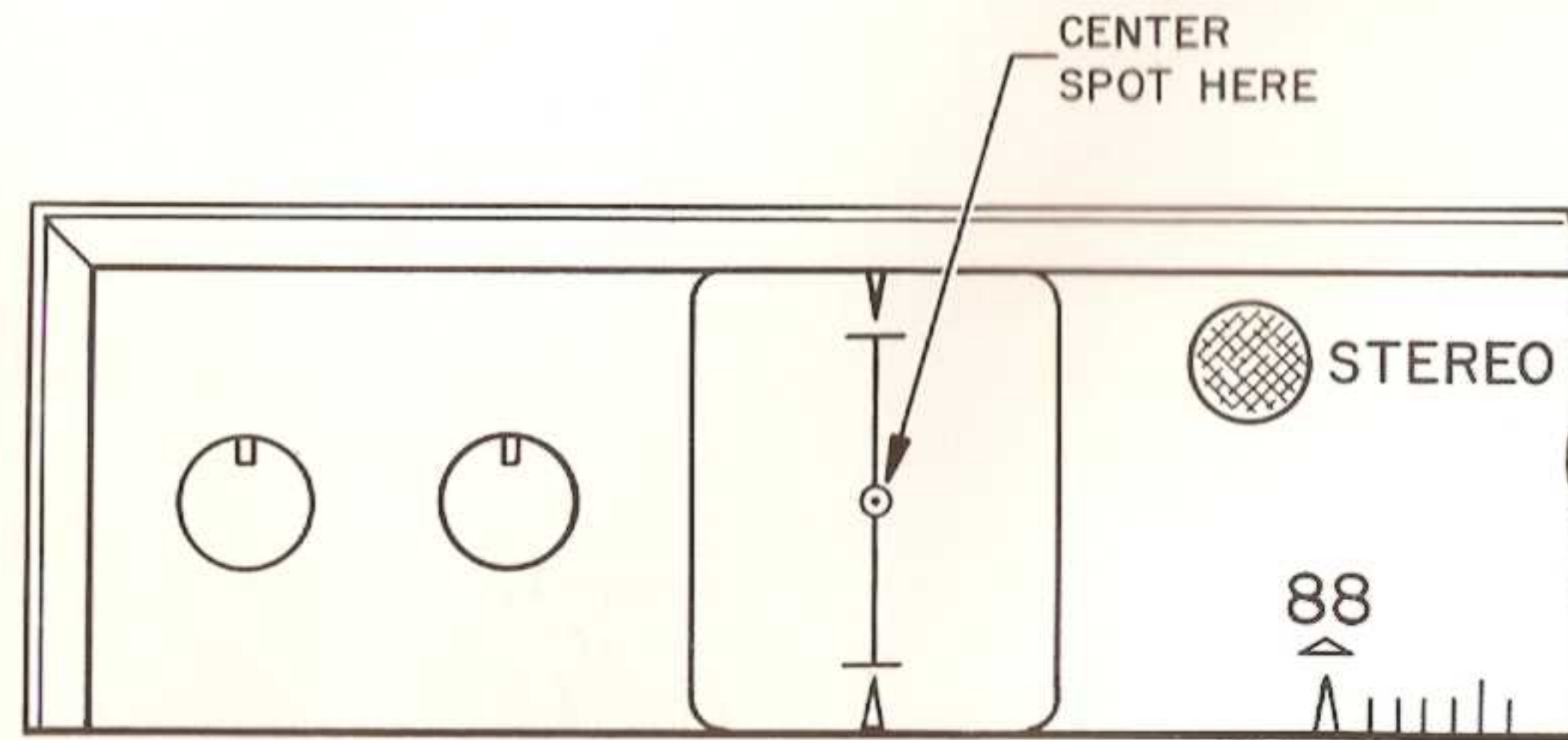

Figure 4. CRT Centering

tuned, the trace should be adjusted by the **TUNING** knob so that it is centered in the upper portion of the rectangle (as illustrated in Figure 5). Weak distant stations can be seen even when they are below the muting threshold. Often orientation of the antenna will increase signal strength sufficiently for reception. In extreme cases, it can be made audible by defeating the muting (depress

Muting Off pushbutton switch). Signal strength will be indicated by the relative height of the trace above the interstation noise level. Strong stations will appear higher on the indicator's center-line and weaker signals will be lower. This indication is approximately logarithmic. Modulation (or deviation) is shown by the instantaneous horizontal expansion and con-

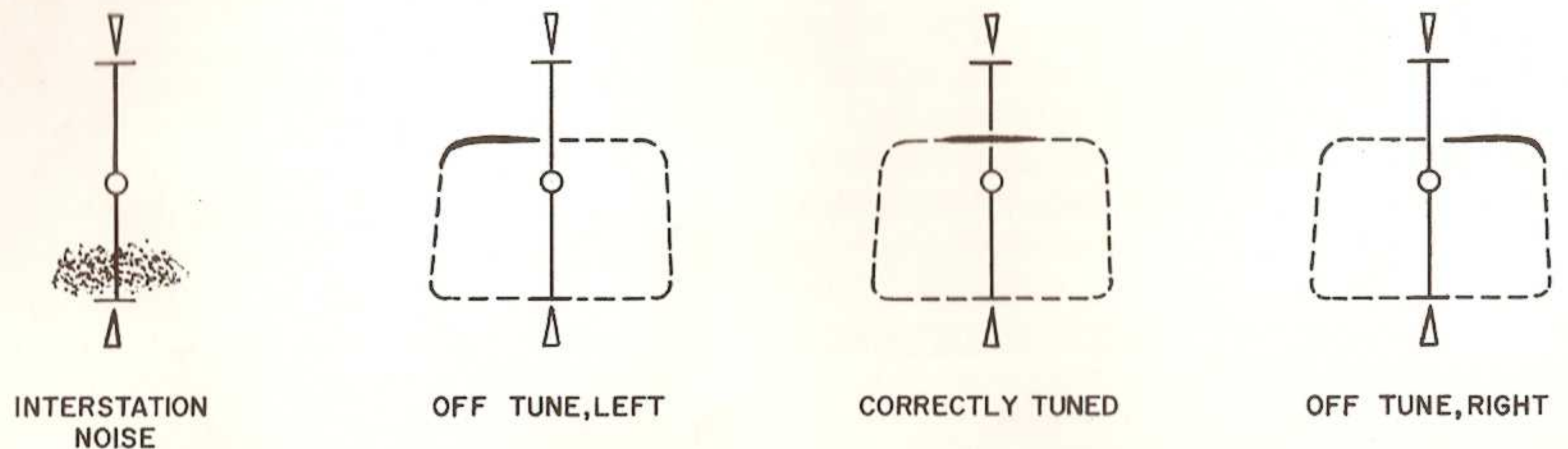

Figure 5. Tuning Display

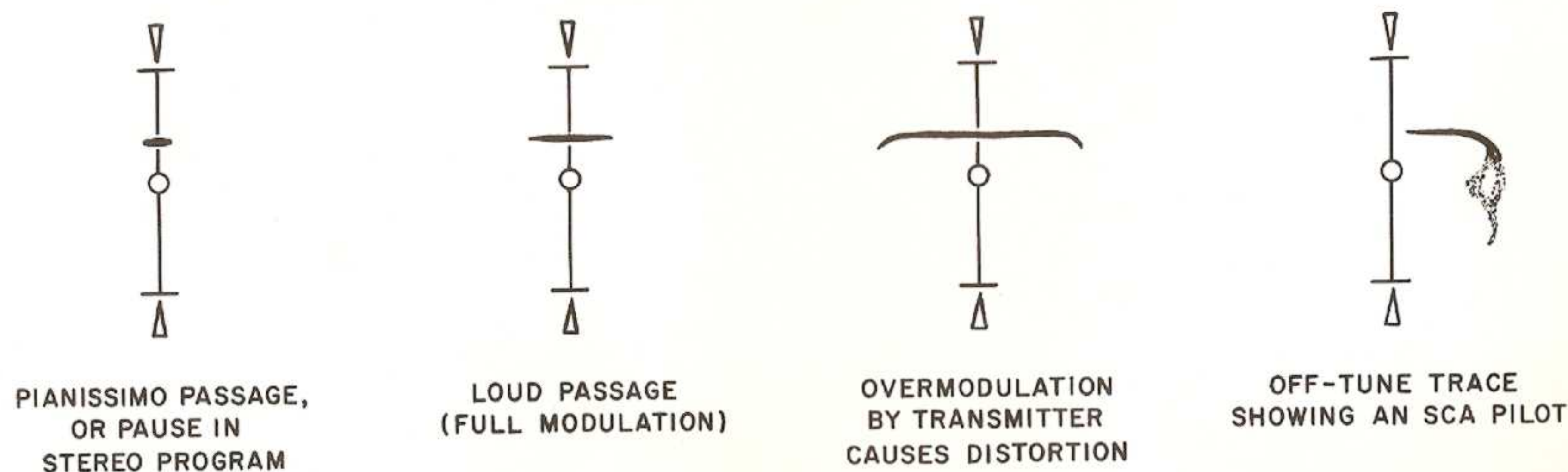

Figure 6. FM Broadcast Modulation Characteristics

traction of the trace from its central point. Relatively long traces indicate loud passages while softer passages are shown by a proportionally shorter trace (as illustrated in Figure 6).

Other characteristics of FM broadcasts are also shown in Figure 6. If an FM station flagrantly over-modulates (grossly exceeds the 75 kHz deviation limits) an excessively long trace will be indicated where the ends curl downward outlining the top of the "I.F. passband characteristics" of the tuner. If an FM station is broadcasting a Subsidiary Communications Authority (SCA) signal along with its regular FM broadcasts, tuning-off on one side of this station usually reveals a trace similar to the last illustration in Figure 6. SCA (sometimes referred to as "store-casting") is privately distributed to commercial users such as restaurants and stores.

The tuning trace will always appear on the display regardless of the position of the

selector switch, provided the **Audio Display** pushbutton is not depressed. In this way, you can tune to a known desired station even when other program material is being heard. Upon switching the selector to **FM**, you will immediately be listening to the desired FM station.

ADJUSTING ANTENNA DIRECTION

The trace on the tuning indicator serves another very useful function, by showing the user when his antenna is rotated in the best possible direction. If the trace should assume a snake-like or distorted shape rather than a relatively smooth horizontal line (shown in Figure 7) this indicates that the antenna is pointing in a direction which is unfavorable for good reception from that station. This type of departure from a smooth line shows the presence of multipath reflections (identical to TV "ghosts") received along with the wanted signal. To obtain the best reception quality from each station, adjust the antenna

to the direction which results in the smoothest and most horizontal indication. This direction may frequently **not** be the same as the direction for the strongest signal (maximum vertical deflection). (For this reason, "signal strength" or "center-of-channel" meters are not appropriate indicators for best quality signal reception)

The shape of illustration B with its long gentle curves is preferable to illustrations C through G and should yield good reception. In turn, illustrations C and D are preferred to E and F. Finally, illustration G indicates a very poor antenna setting resulting in an actual signal cancellation with unacceptably noisy and distorted reception.

PUSHBUTTON SWITCHES

The pushbutton switch functions are engaged when the pushbutton is depressed. A depressed pushbutton can be released to its normal "out" position by pushing in once again and then releasing.

Phono 2 Switch Selection of the phono source is determined by the position of the **Phono 2** pushbutton switch. When the selector switch is in the **PHONO** position and the **Phono 2** pushbutton switch is in the "out" position, signals from the **PHONO** jacks are fed to the preamplifier section. When the **Phono 2** switch is depressed, signals from the **PHONO 2** jacks are fed to the preamplifier section. Phono signals from both **PHONO** and **PHONO 2** input jacks have precise RIAA equalization introduced.

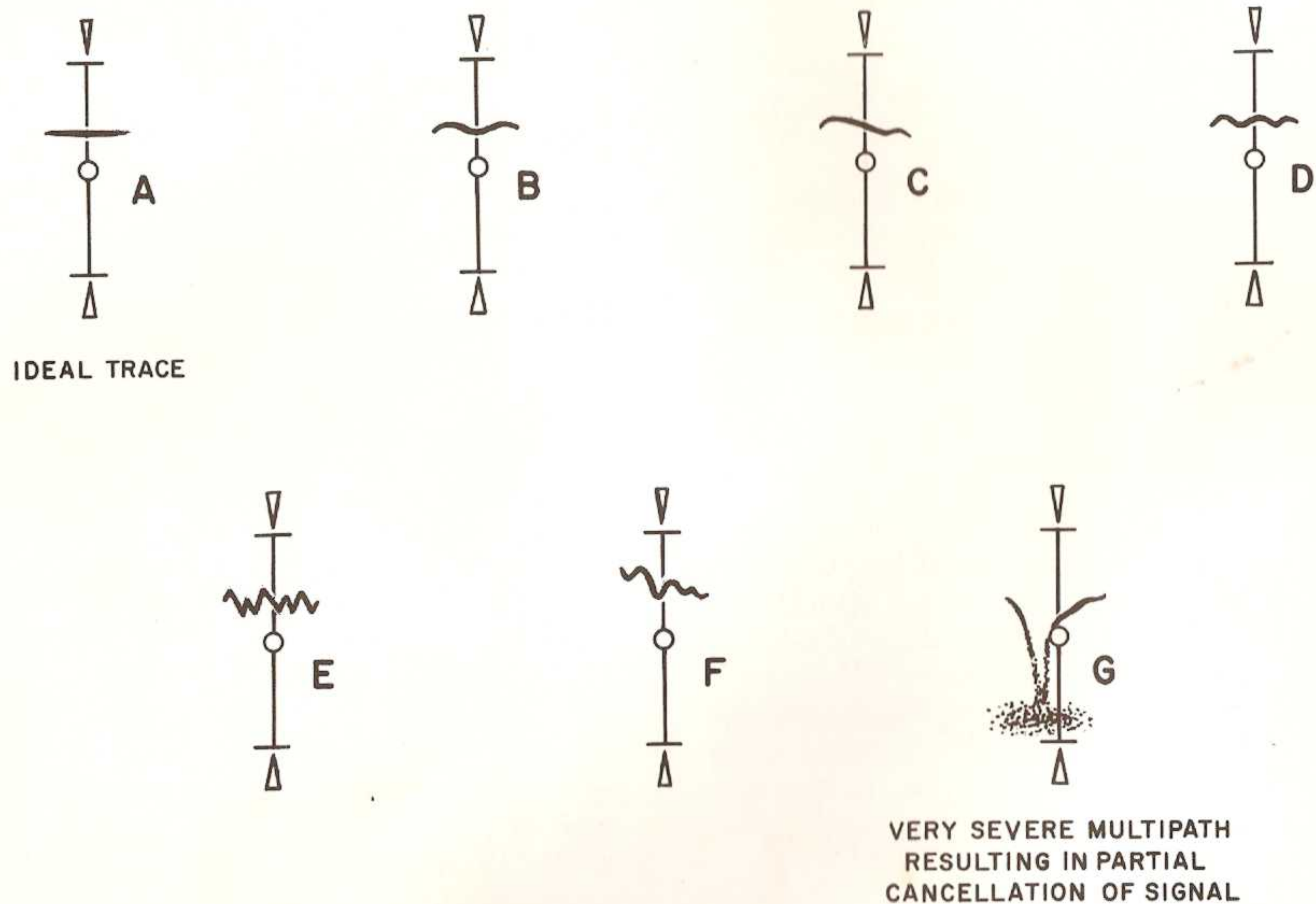

Figure 7. Adjusting Antenna Direction

Mono (L+R) Switch Depressing the **Mono (L+R)** pushbutton switch converts all input signals and all output signals to the monophonic mode, including signals at the **RECORDING OUTPUT** jacks and **DUBBING OUT** jack.

When playing a single channel source such as TV or AM, use the **Mono (L+R)** switch to

feed the signal through both channels of the Eighteen.

When playing a monophonic record use this switch to effectively suppress rumble and pinch-effect distortion on the record, thus improving listening quality.

When playing a monophonic tape from a

stereo tape recorder, turn-down the recorder's playback volume control on the unwanted channel, turn the selector switch to **TAPE**, and depress the **Mono (L+R)** switch. This allows the signal from one of the **TAPE INPUT** jacks to be fed through both channels of the Eighteen. If your recorder has no facility for turning-off the unused channel, it will be necessary to temporarily remove the audio cable of the unwanted channel.

Tape Monitor Switch When this pushbutton is "out", the program source being heard or recorded is determined by the setting of the selector switch. If the **Tape Monitor** pushbutton switch is depressed, only the program source connected to the **TAPE INPUT** jacks on the rear panel or the **DUBBING IN** jack on the front panel, is heard. However, the program source indicated by the selector switch continues to be fed to the **TAPE RECORDING OUTPUT** jacks on the rear panel and the **DUBBING OUT** jack on the front panel. This facility permits you to feed any program source to your tape recorder while you listen to the "results" of the recording as it is in progress.

Audio Display Switch With the **Audio Display** pushbutton switch in the "out" position, and the selector switch set to any program source, the oscilloscope shows FM station tuning and multi-path displays as described previously. Depressing the **Audio Display** switch presents a stereo display of the left and right audio channels which can be used to check the separation and phase of the program material from all sources connected to the Model Eighteen.

When the selector switch is set to the FM position, it can be used to check the separation of FM transmissions as well as phase of the program material. It occasionally happens (by accident or intent) that a selection is transmitted monophonically during a stereo broadcast. This sudden loss of stereo separation might cause some mis-givings to the listener if it were not for this simple test built into the Model Eighteen. Technically, this display of left and right audio channels is an X-Y plot or Lissajou figure. With the use of the illustrations shown in Figure 8, the user can quickly analyze the program material. This same test can be made for tapes, discs, or any other source. This visual display of the sound is not affected by the volume, balance, bass, treble, Hi Filter, or Lo Filter controls.

Hi Blend Switch When the Hi Blend pushbutton switch is depressed there will be a reduction in high frequency stereo separation. With usual listening, the switch should be in the normal "out" position. When listening to distant FM stereo programs with excessive background noise or interference, depressing the Hi Blend switch will blend the left and right channels at high frequencies combining the advantages of moderate stereo separation with moderate suppression of out-of-phase noise and distortion components while maintaining full frequency response. This method differs from ordinary FM stereo noise filters which eliminate noise by reducing the high frequency response.

On noisy FM stereo broadcasts which cannot be satisfactorily improved by the use of the Hi Blend switch, use of the Mono (L+R)

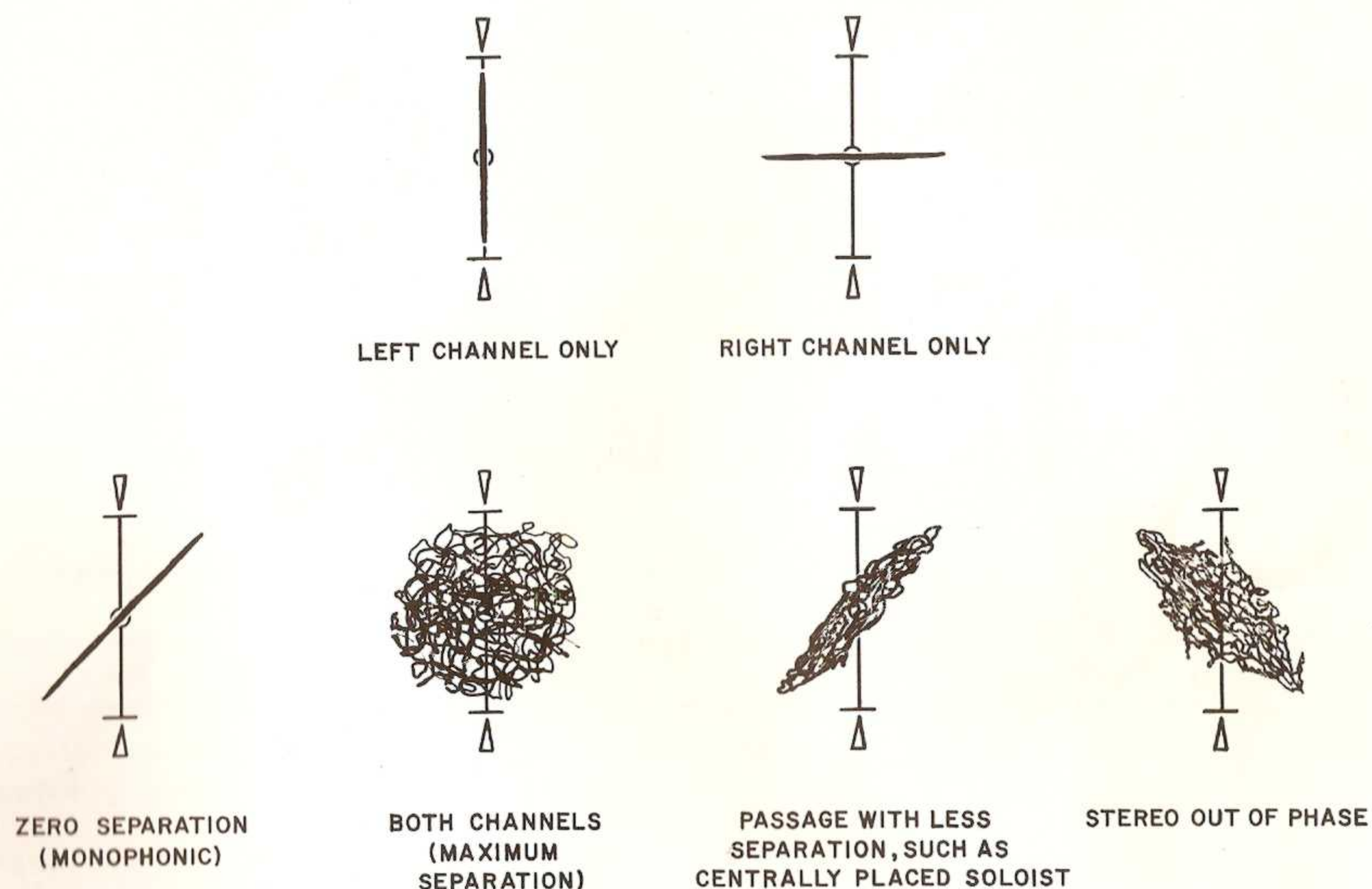

Figure 8. Audio Display

switch will completely eliminate all noise attributable to stereo reception; Of course, the stereo broadcast will then be received monophonically.

When listening to records, the Hi Blend filter will partially cancel pinch-effect distortion and "vertical" noise components.

Because tape "hiss" is not coherent in both channels, the Hi Blend switch will have

virtually no effect on this noise when listening to tape.

The Hi Blend switch affects all audio input and output signals except if the Tape Monitor switch is depressed. When "monitoring" tape, (Tape Monitor switch depressed) DUBBING IN, TAPE INPUT, STEREO-PHONES, and loudspeaker outputs are not affected by the Hi Blend switch.



Figure 9. Front Panel Controls, Jacks, and Display CRT

Lo Filter Switch The low frequency filter can be used to reduce turntable rumble and low frequency noises. Obviously, use of the filter will reduce desired low frequency sounds as well as the unwanted noise, therefore, the filter should be used judiciously with troublesome program sources. With the **Lo Filter** pushbutton switch in the "out" position, the low frequency filter is switched out of the circuits.

Hi Filter Switch The high frequency filter can be effective in suppressing tape "hiss" or the "scratchy" sound from poor-quality or carelessly handled records. If an AM radio signal is being fed to the Eighteen, this filter will considerably reduce the 10

kHz "whistle" effect. With the **Hi Filter** switch in the "out" position, the high frequency filter is switched out of the circuits.

Muting Off Switch When listening to FM broadcasts with the **Muting Off** switch in its normal "out" position, an inter-station muting circuit reduces noise to a comfortably low level while tuning from station to station. Because very weak stations may also be muted along with the noise, muting may be turned off by depressing this switch when tuning to a weak station.

MAIN CONTROLS

selector As the name implies, this switch

selects the program source you wish to hear or record. If you have connected your tape recorder's playback output to the **TAPE INPUT** jacks on the rear panel, you may select tape listening by rotating the **selector** switch to the **TAPE** position (with the **Tape Monitor** pushbutton switch in the "out" position).

When recording an FM broadcast, for example, you would set the **selector** switch to FM in order to feed the signals from the tuner section to the high-level (or "line") inputs of your tape recorder. You would be listening to the program directly from the tuner. When the **Tape Monitor** pushbutton

switch is depressed, you would be listening to ("monitoring") the "results" of the recording while it is in progress (assuming, of course, that the recorder is equipped with separate record and playback heads and separate record and playback preamplifiers). You will note that the use of the **Tape Monitor** switch while recording, in **no** way affects the signal recorded on the tape.

balance This wide-range adjustment alters the level of either output channel in situations where it is necessary to correct unbalanced programs sometimes encountered in older stereo recordings, and in some present-day stereo broadcasts. As it is turned away from the "normal" position, it simultaneously increases the level in one output channel and decreases the level in the other channel. (Because the **balance** control knob has been set for precise **electrical** balance when the pointer is at the indicator dot [straight up], there may be slightly greater mechanical rotation off-center in one direction than the other.)

volume This precision dual control maintains stereo balance within 3 dB at all normal settings. It controls the level of both output channels simultaneously. It has no effect on the recording outputs or the scope display.

bass and treble These controls alter the tonal balance of program signals to suit individual listening preference. Each control is of the dual concentric friction-coupled type. Because each control has a dual section, it is possible to compensate for unbalanced room acoustics or any other tonal imbalance

conditions between the channels of stereo program material. The friction-coupled feature conveniently allows simultaneous tonal adjustment of both channels. The smaller control knob adjusts the response of the left audio channel, while the larger control knob adjusts the right audio channel.

At low listening levels, the bass boost can be adjusted to closely match the difference in Fletcher-Munson loudness contours, therefore, you can use the bass controls to maintain tonal balance at these levels. In this way, apparent loudness of musical tones is equalized. Treble boost may be added if desired, but is not required for correct loudness compensation. (Because the tone control knobs have been individually set for precise **electrically** flat response when the pointers are at the indicated dot [straight up], there may be slightly greater mechanical rotation off-center in one direction than the other.)

speaker systems switch This switch selects the loudspeaker terminals to which audio power is fed. Either the **MAIN** or the **REMOTE** pair of loudspeakers may be selected individually, or **BOTH** loudspeaker systems may be selected simultaneously.

When the **speaker systems** switch is rotated to the **OFF** position all loudspeaker terminals are internally disconnected from the power amplifier section of the Eighteen. The **STEREOPHONES** jack, however, is **always** connected and is **not** affected by the **speaker systems** switch. The **OFF** position allows "private listening" when stereo headphones are plugged into the **STEREOPHONES** jack.

FRONT PANEL JACKS

DUBBING OUT At all times this output is internally connected in parallel with the **TAPE RECORDING OUTPUT** jacks on the rear panel. Thus any signals available at the jacks on the rear panel are simultaneously available at the front panel. You can connect the recording inputs of an external recorder to this jack, using a standard 3-conductor phone plug. Plugs of this type have an insulated tip, and insulated ring, and a sleeve which is generally used for common return or ground. The tip of the plug receives the left channel of a program, whereas the ring receives the right channel. Refer to Figure 10.

DUBBING IN This jack has a built-in switch which automatically disconnects the rear panel **TAPE INPUT** jacks when you insert a standard 3-conductor phone plug. You can connect the playback outputs of an external tape recorder to this jack.

STEREOPHONES This jack accepts the standard 3-conductor phone plug used on standard stereo headphones. (See Figure 10) It is fed from the power amplifier section through isolation resistors, and gives optimum results with popular low impedance

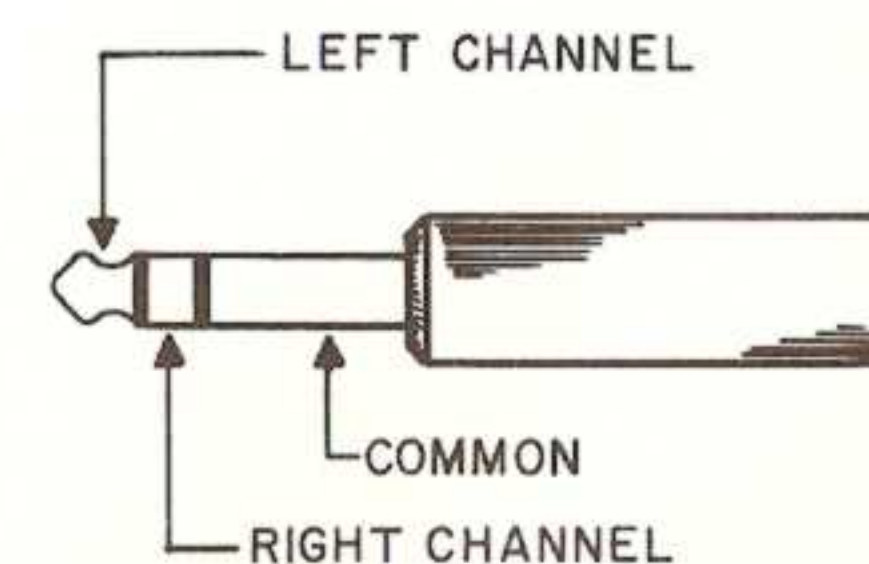

Figure 10. Stereo Phone Plug

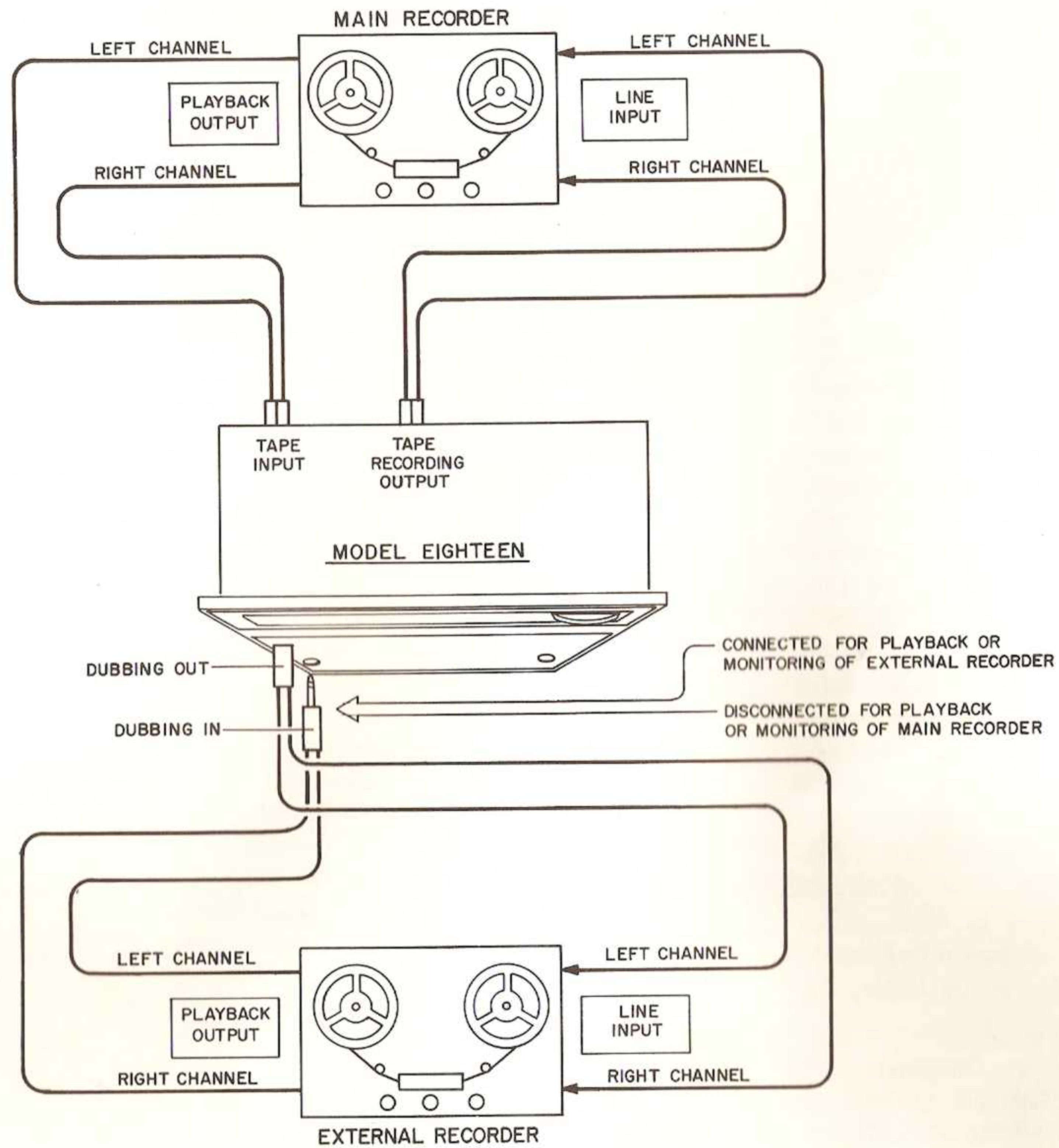

Figure 11. Arrangement of Two Tape Recorders

headphones. However, excellent results will also be obtained with high impedance headphones. Two or more sets of headphones may be used with the aid of "Y" connectors. The STEREOPHONES jack is not affected by the speaker systems switch.

SOME SUGGESTIONS ON USING TAPE RECORDERS WITH YOUR MODEL EIGHTEEN

There are several ways to connect and operate tape recorders with your receiver. To avoid confusion in the following discussion, references to "tape monitoring" assume that the recorder is equipped with separate record and playback heads and separate record and playback preamplifiers. To further simplify this discussion, a tape recorder usually connected to the rear panel facilities of the Eighteen will be referred to as the "main" recorder; a separate recorder usually connected to the front panel jacks will be referred to as the "external" recorder. This general arrangement is shown illustrated in Figure 11.

Recording and Playback The simplest system involves only one tape recorder, whose line or "radio" inputs are connected to the TAPE RECORDING OUTPUT jacks (on the rear panel) and whose playback outputs are connected to the TAPE INPUT jacks. An equally simple arrangement using the front panel facilities, involves connecting the line inputs to the DUBBING OUT jack and the playback outputs to the DUBBING IN jack.

Recording To make a recording, set the selector switch to the desired program source

and put the recorder into the "record" mode of operation. With the Tape Monitor switch in the "out" position, you can listen to the original program source. By depressing the Tape Monitor switch you can listen to (monitor) the "results" of the recording while it is in progress. A word of caution—when operating your recorder in the record mode, be careful not to inadvertently place the selector switch in the TAPE position when the Tape Monitor switch is "out". Doing this feeds the recorder's output signals back to its input terminals, establishing a reverberation loop. If the recorder's playback level happens to be set higher than its record level, the resulting echo or "howl" will rapidly increase in volume level. No harm will be done to the recorder or to the Eighteen, but the audible effect from your loudspeakers can be annoying.

Playback To listen to a tape already recorded, put the recorder in the playback mode of operation and turn the selector switch to TAPE. When playing back a tape on the external recorder, the recorder's playback outputs should be connected to the DUBBING IN jack on the front panel. When playing back a tape on the main recorder, make sure nothing is plugged into the DUBBING IN jack, otherwise the main recorder's playback outputs will be internally disconnected in the Eighteen.

Making Two Tape Recordings Simultaneously You can make two tape recordings at the same time by connecting two tape recorders to the Eighteen, as shown in Figure 11. To monitor the external recorder,

plug the recorder's playback output into the DUBBING IN jack, and depress the Tape Monitor switch. To monitor the main recorder, pull the plug out of the DUBBING IN jack and depress the Tape Monitor switch.

Recording a Long Duration Program

With two tape recorders connected to the Eighteen as shown in Figure 11, you can make a continuous recording without losing parts of the program during reel changes. For example, with the selector switch set to the desired program source, and the Tape Monitor switch in the "out" position, you can start the recording on the main recorder, then prepare the external recorder to begin recording at a convenient program pause before the main recorder is about to run out of tape. As soon as the external recorder is started, you will have ample time to reload the main recorder in preparation for further recording. This process can be repeated indefinitely with both machines. At any time during the recording session, you can monitor the recording by depressing the Tape Monitor switch.

Remember: **disconnect** the plug from the DUBBING IN jack to monitor the main recorder; **insert** the plug to monitor the external recorder.

COPYING AND EDITING

Using the input/output and control facilities of the Eighteen, and two tape recorders, you can copy and edit tapes from one machine to the other making modifications, if desired, in tonal balance, noise level, stereo balance, etc.

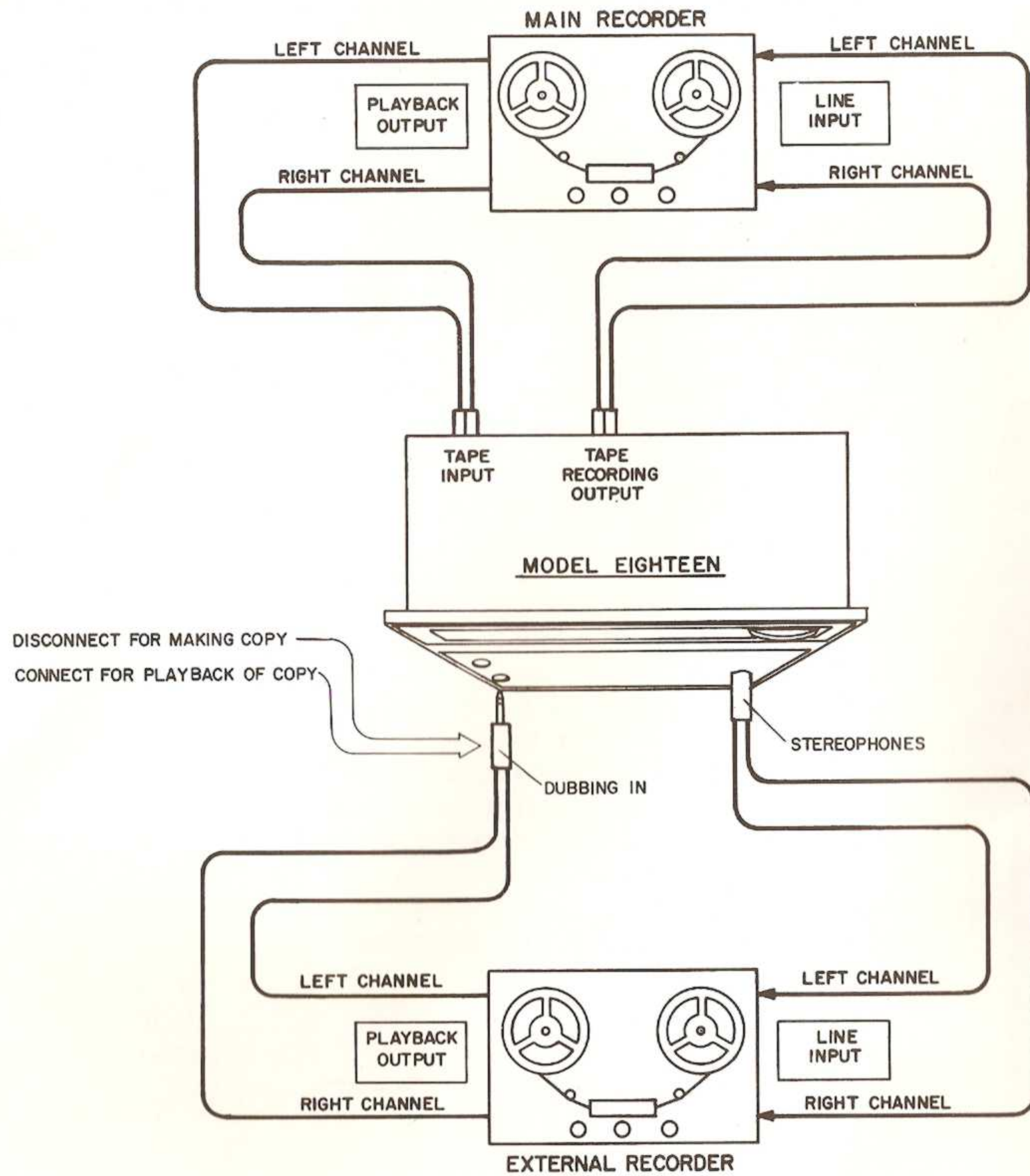

Figure 12. Arrangement for Making Modified Tape Copies

The general arrangement of equipment for copying and editing is illustrated in Figure 11. To copy from the main recorder to the external recorder:

- Step 1.** Disconnect the plug from the **DUBBING IN** jack.
- Step 2.** Set the **selector** switch to **TAPE** and **Tape Monitor** switch to "out" position.
- Step 3.** Put the main recorder into the playback mode and the external recorder into the record mode.

To copy from the external recorder to the main recorder:

- Step 1.** Insert the plug into the **DUBBING IN** jack.
- Step 2.** Set the **selector** switch to **TAPE** and **Tape Monitor** switch to "out" position.
- Step 3.** Put the external recorder into the playback mode and the main recorder into the record mode.

To edit or leave out program material you do not wish to include in the copy, simply stop the machine that is in the record mode, while the unwanted program material is playing. Some machines are equipped with a convenient "pause" control for this purpose.

MODIFYING A TAPE COPY

To modify a tape recording (emphasize or deemphasize "highs", "lows", or both), you can copy (dub) it while using the controls of the Eighteen (balance, bass, treble, **Lo Filter**, **Hi Filter**). The equipment arrangement for making this type of copy is illustrated in Figure 12. Notice that in this arrangement, the recording input signals for the external recorder are taken from the **STEREOPHONES** jack on the Eighteen instead of the **DUBBING OUT** jack.

NOTE

If the external recorder's input sensitivity is not sufficient to utilize signals fed to the **STEREOPHONES** jack when the Eighteen's volume control is adjusted to give a comfortable listening level through the speakers, turn the **speaker systems** switch to **OFF** and advance the **volume** control to give sufficient signals from the headphones jack. If this is required, more careful preparation is necessary prior to making the copy because no sound can be heard from your loudspeakers.

The original tape is played on the main recorder; the copy is made on the external recorder. To make the copy:

- Step 1.** Disconnect the plug from the **DUBBING IN** jack.

- Step 2.** Set the **selector** switch to **TAPE** and the **Tape Monitor** switch to "out" position.

- Step 3.** Put the main recorder into the play mode and adjust the controls of the Eighteen for the desired sound quality.

- Step 4.** Put the external recorder into record mode.

To play back the copy after it is rewound:

- Step 1.** Depress the **Tape Monitor** switch.

- Step 2.** Insert the plug into the **DUBBING IN** jack.

- Step 3.** Put the external recorder into the play mode.

Remember that the copy tape contains a modification of the sounds on the original tape. Therefore, when playing back the copy, the controls of the Eighteen should be readjusted for "normal" (unmodified) operation. For example, if the **Hi Filter** was used during the copying process to reduce high-frequency noise to a satisfactory level, it should be returned to the "out" position when playing back the copy tape.

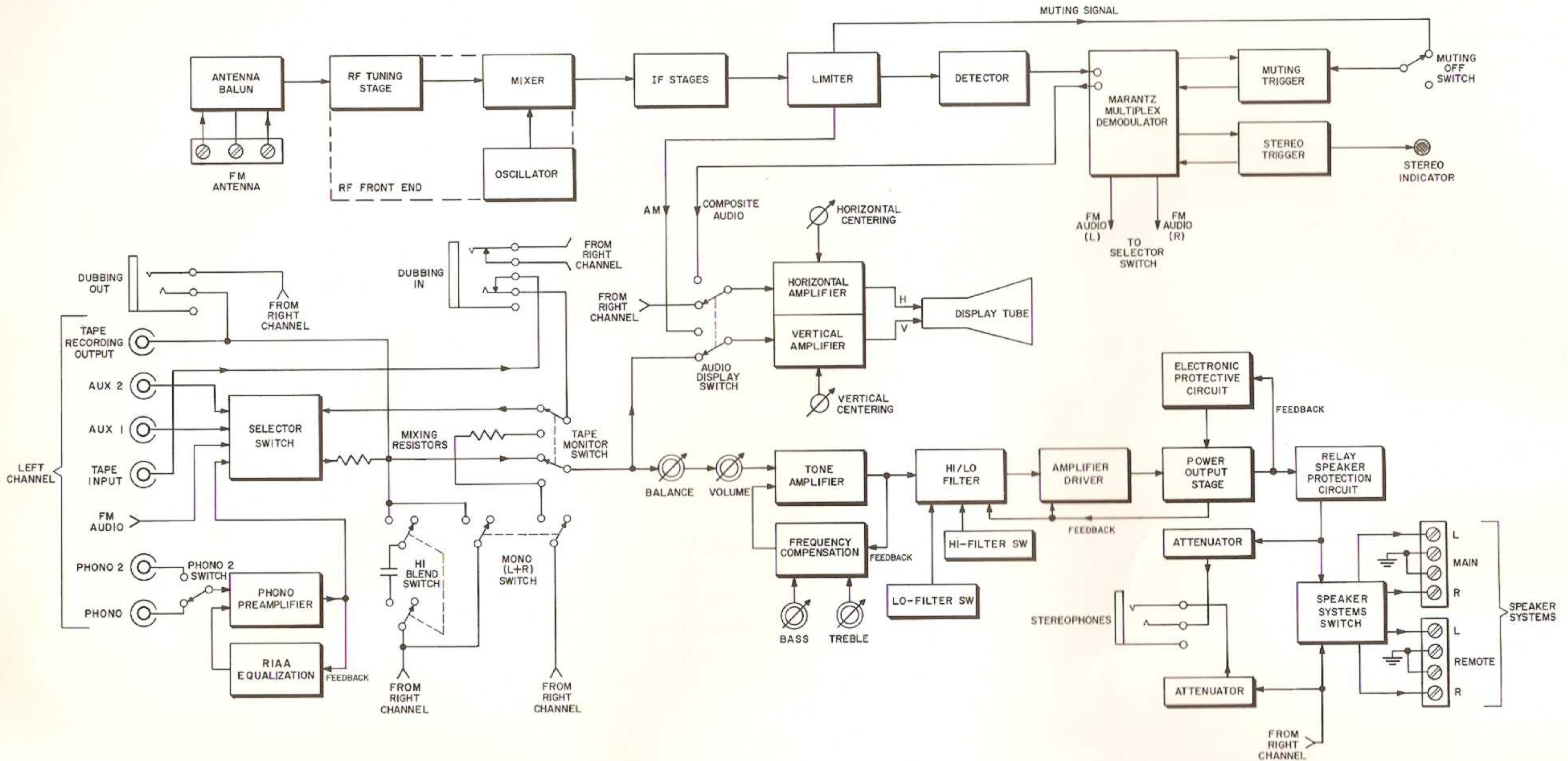

Figure 13. Functional Block Diagram

TECHNICAL DESCRIPTION

GENERAL

Figure 13 is a block diagram of the Eighteen Receiver showing the principal functional ele-

ments and input and output signal routing. The functional elements for the FM tuner and "scope" display sections are complete. For clarity, only the left audio channel is shown; the right audio channel is identical. The **Mono (L+R)** and **Hi Blend** switches are common to both channels. All audio con-

trols are ganged, or concentrically clutched, to their counterparts in the right channel. The left channel half of the front panel **DUBBING IN**, and **DUBBING OUT** jacks are shown interconnected in this diagram. The right channel of each jack is wired to the same circuit point in the right channel.

FUNCTIONAL DESCRIPTION

Front End FM antenna signals are applied through an antenna balun to the "passive" RF tuning stage (station selecting circuit). The tuned signal is fed to a balanced-bridge diode mixer and oscillator stage, which converts the carrier frequency to the 10.7 MHz Intermediate Frequency. Careful attention to thermal and electrical characteristics has minimized drift, thus obviating the necessity for AFC, and its undesirable side effects. The 10.7 MHz converted signal is then fed to a linear-phase I.F. filter, followed by a small dynamic-aperture limiter, and then in turn, processed through an FM discriminator. The output of the FM discriminator is fed to a multiplex demodulator before the audio is routed to the selector switch.

I. F. Stages The I.F. section is a modified Butterworth-type filter configuration. The characteristics of this filter are ideal in that the 200 kHz passband is phase-linear, with sharp cutoff slopes. Its exceptional phase linearity assures the elimination of a major source of high frequency distortion and loss of stereo separation. The sharp cut-off slopes provide improved selectivity, permitting reception of closely spaced channels.

Limiter The Model Eighteen utilizes a limiter amplifier with a very small dynamic asymmetrical aperture, eliminating the need for AGC circuits which introduce low frequency distortion.

In addition to the usual input and output of

the limiter stages, a muting signal and an Amplitude Modulation signal is derived from the Model Eighteen limiter. The muting signal is routed through the **Muting Off** switch to the muting trigger. When the carrier is greater than a pre-determined level, the trigger is activated and the muting circuit is disabled, allowing the audio to be fed through the multiplex circuit unattenuated. Undesirable Amplitude Modulation (AM signals, AM noise, AM distortion) is removed from the I.F. signal within the limiter, rectified, and coupled to the **Audio Display** switch which feeds the vertical "scope" amplifier for the multipath display.

Multipath Display The composite audio output of the detector is fed to the Marantz multiplex demodulator circuit. Before decoding, this composite signal is also fed to the **Audio Display** switch which feeds the horizontal scope amplifier for the multipath display. When the **Audio Display** switch is in the "out" position, the CRT presentation shows station tuning and broadcast characteristics. The FM composite audio (instantaneous deviation) is displayed horizontally and carrier amplitude (and amplitude variations) are displayed vertically. This display (multipath shown by snake-like, distorted scope trace) visually indicates correct orientation of the antenna for best reception, with a minimum of Amplitude Modulation (multipath) distortion. A perfectly flat tuning trace indicates no multipath.

Demodulator The composite audio containing the stereo information is fed through

the muting circuit and into the multiplex demodulator circuit. The Marantz multiplex decoding circuit contains a sharp 67 kHz filter which traps any SCA pilot which may be present in the composite audio. The multiplex circuitry detects the transmitted 19 kHz stereo pilot signal and doubles its frequency to 38 kHz. With the proper phase relationship to the audio, it synchronizes the free-running oscillator (in order to re-insert the suppressed stereo subcarrier). In addition, the detection circuit activates the stereo trigger which turns on the stereo indicator lamp and switches in the multiplex decoding circuit. When no 19 kHz pilot is detected, the stereo trigger is de-activated causing the stereo indicator to turn-off. In addition, the multiplex decoding circuit is disabled and the monophonic audio signal is fed directly through the de-emphasis networks to both channels of the selector switch.

selector switch The function of the selector switch is to feed the low-level or the desired high-level signal through the **Tape Monitor** switch to the balance control and **Audio Display** switch. All inputs except the selected input are shorted. The output of the selector switch is connected to the **TAPE RECORDING OUTPUT** and **DUBBING OUT** jacks through a series resistor.

Tape Signals With the exception of tape input, all high-level inputs are fed directly to the selector switch. Tape input is routed through the front panel **DUBBING IN** jack to a section of the **Tape Monitor** switch. The **DUBBING IN** jack is a three conductor stereo jack which has two built-in switches, one for each channel. Normally,

these switches are closed allowing the tape input signals from the **TAPE INPUT** jack on the rear panel to be fed to the **Tape Monitor** switch. When a plug is inserted in the **DUBBING IN** jack, the switches are opened, disconnecting the **TAPE INPUT** jacks and allowing the signal from the **DUBBING IN** jack to reach the **Tape Monitor** switch. Thus only one tape recorder at a time can feed playback signals into the Eighteen.

Tape Monitor Switch When the **Tape Monitor** switch is in the "out" position, tape input signals from the **TAPE INPUT** jacks on the rear panel or **DUBBING IN** jack on the front panel are fed to the selector switch. In addition, the output of the selector switch is fed (through a series resistor) through the **Tape Monitor** switch to the balance control and **Audio Display** switch. When the **Tape Monitor** switch is depressed the output of the selector switch is disconnected from the balance control and **Audio Display** switch, allowing the tape input signals from the **TAPE INPUT** or **DUBBING IN** jacks to bypass the selector switch and feed the balance control and **Audio Display** switch directly.

Phono Signals The **Phono 2** push-button switch selects **PHONO** or **PHONO 2** inputs for preamplification in the phono preamplifier circuit. Phono signals of up to 80 mV can be handled without overloading. The RIAA equalization network provides precise equalization and sets the voltage gain of the phono preamplifier to 42 dB (at 1,000 Hz). This RIAA reproducing characteristic, to-

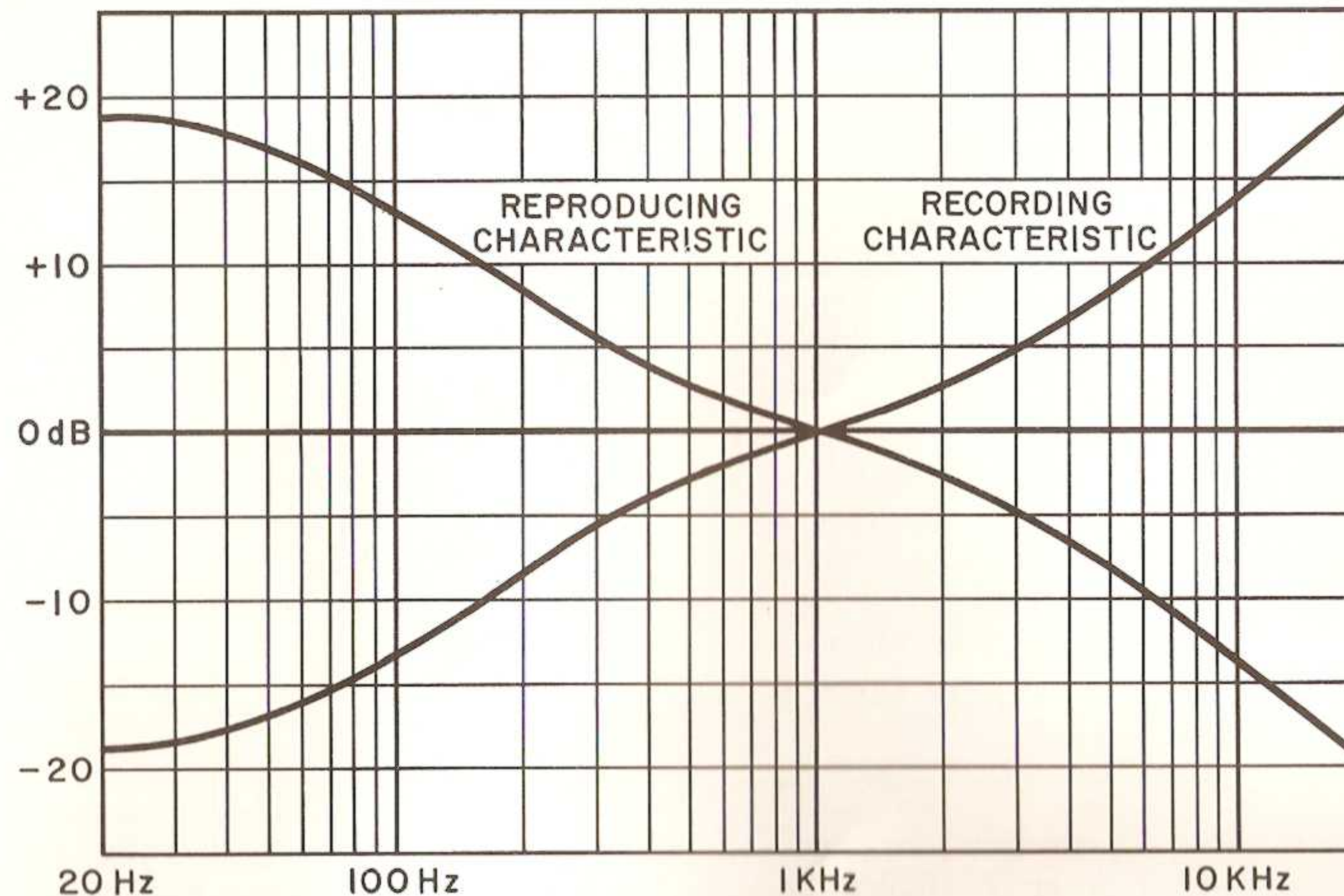

Figure 14. Phono Equalization Characteristics

gether with the recording characteristic, is shown in Figure 14. Notice that the net result after playback is a flat response.

Hi Blend and Mono (L+R) Functions

When the **Hi Blend** switch is depressed the left and right channel outputs of the selector switch are connected together through mixing resistors and a capacitor. The value of the capacitor has been selected to effect moderate suppression of out-of-phase noise and distortion components while maintaining moderate stereo separation.

When the **Mono** switch is in the "in" position, the two channels are connected directly together through mixing resistors. In addition, the left and right channel tape input signals are connected together through a similar resistor network. This facility allows all inputs to be converted to the monophonic mode.

Audio Display Switch The **Audio Display** switch selects the multipath/tuning presentation or the left/right audio display shown on the oscilloscope. When this switch is in the "in" position it connects the

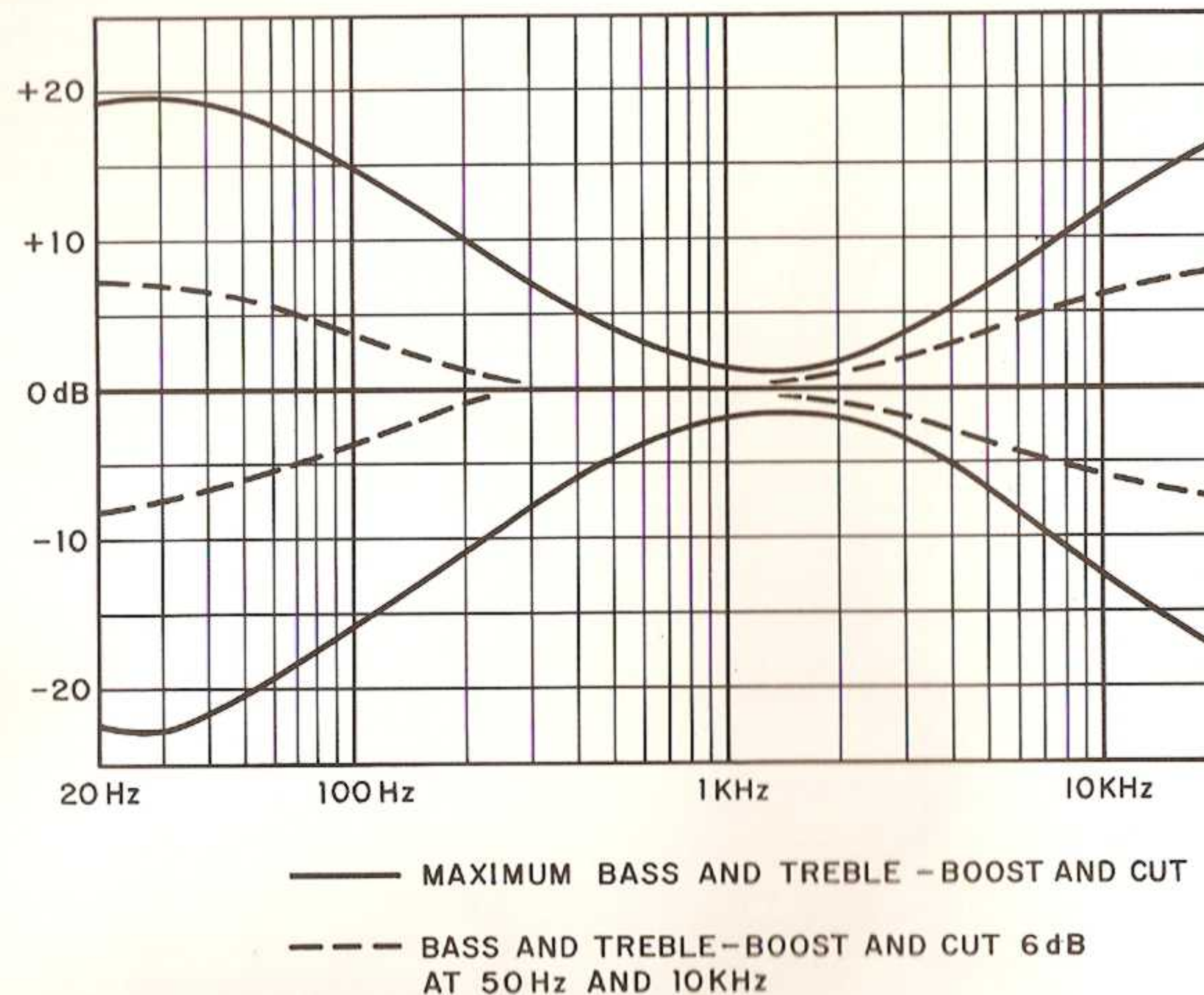

Figure 15. Tone Control Characteristics

vertical "scope" amplifier to the input of the left channel section of the **balance** control. Simultaneously, the horizontal scope amplifier is connected to the input of the right channel section of the **balance** control. In the audio display mode, all audio signals through the Eighteen are displayed as an X-Y (left/right) plot to show separation and phase relationships of the information. In the "out" position of the switch the vertical and horizontal scope amplifiers are connected to the Amplitude Modulation (multipath) and FM composite audio signals respectively.

Control Circuits The control circuits portion of the model Eighteen consists of the **balance**, **volume**, **bass**, **treble**, **Hi Filter**, and **Lo Filter** controls. All controls affect the left and right channels simultaneously. The **bass** and **treble** controls have clutched-sections which allow individual adjustment of tonal balance for each channel. Signals through the **Tape Monitor** switch are adjusted for relative and overall level by the **balance** and **volume** controls respectively. With the controls set for flat response and **volume** control at maximum, the overall voltage gain from any high-level input to loudspeaker terminals

is approximately 45 dB.

The **balance** control is a wide-range control which permits attenuation of each channel to cutoff. When the pointer is set to the indicator dot, attenuation is approximately 3 dB in each channel. The change of attenuation in each channel, as the control is turned away from center, has been designed to maintain total apparent loudness from both channels. This feature makes it a true stereo balance control. The **volume** control attenuates both channels simultaneously and maintains tracking to within 3 dB to any point of attenuation to -50 dB from maximum. Since the control is situated at the input of the tone amplifier, there is no possibility of overloading the amplifier stages under maximum rated output conditions. Thus distortion is kept to a minimum.

After attenuation by the **balance** and **volume** controls, the signal is applied to the tone amplifier. Its circuitry uses a continuously-variable Baxandall feedback-type configuration whose response curves closely match the difference in the Fletcher-Munson loudness contours. Figure 15 shows the frequency response curves for maximum boost and cut for each control and the curves for 6 dB boost and cut at 50 Hz and 10 kHz.

The signal from the tone amplifier feeds the hi/lo filter circuit which obtains feedback from the power output stage. When the **Hi**

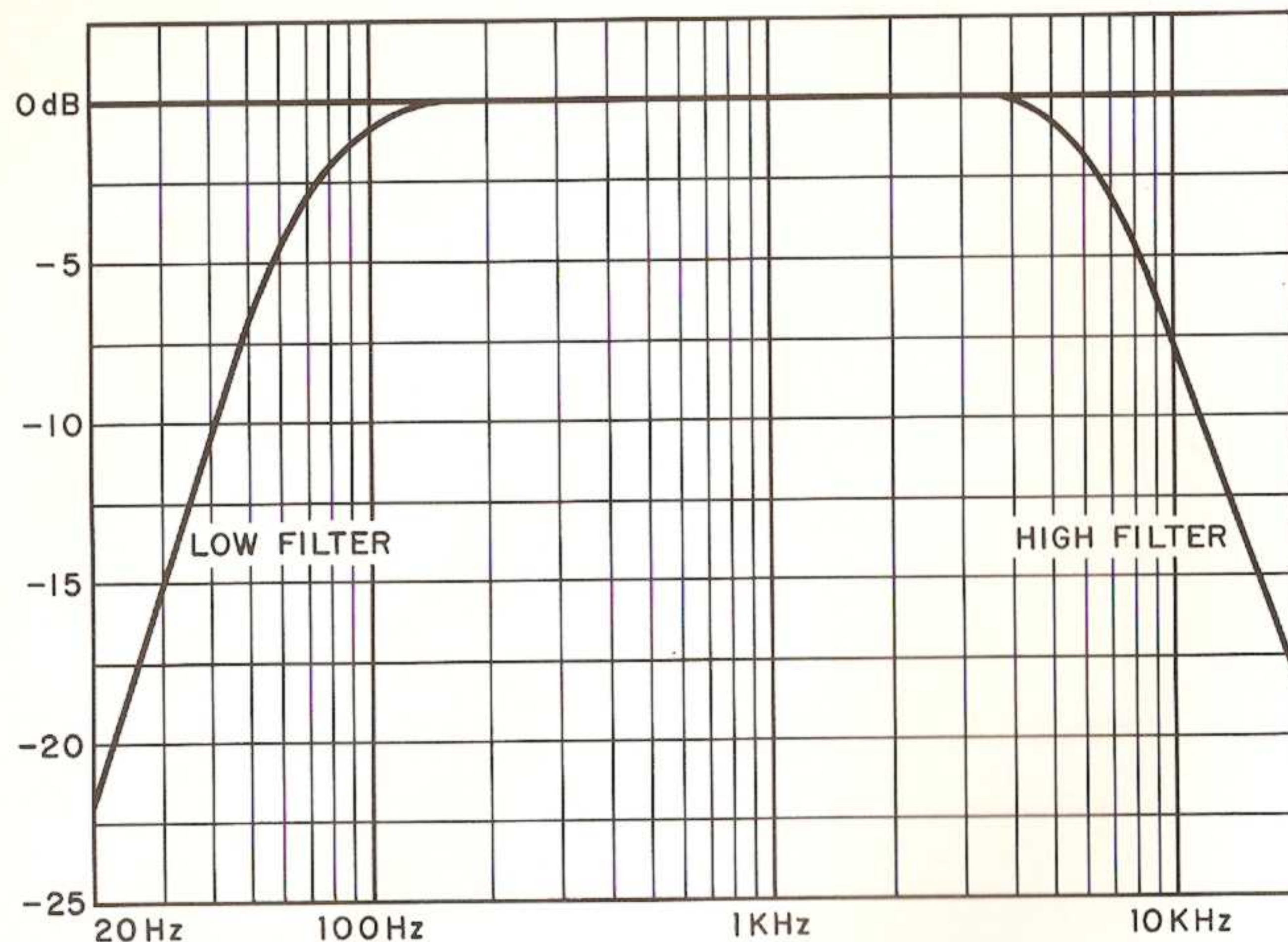

Figure 16. Low and High Filter Characteristics

Filter or the Lo Filter switch is engaged, a filter network is switched into the feedback loop to attenuate the response of the circuit at a rate of 12 dB/octave. These networks provide a double time-constant transfer function characterized by a sharp cutoff (3 dB down at 70 Hz and 7 kHz for the low and high filters respectively). Figure 16 shows the frequency response curves resulting from use of the two filters.

Output Stage and Protective Circuits
The pre-driver circuit amplifies the signal

from the hi/lo filter to sufficient levels to drive the output stage. Beyond the input of the pre-driver circuit the amplifier stages are direct-coupled through to the loudspeakers (and headphones) providing instantaneous recovery from overdrive, or short circuit conditions. After turn-on, the constant current supply for the pre-driver input stage provides a 4 to 6 second delay before the circuit is activated. This eliminates extraneous turn-on pulses and noise. The output stage consists of a pair of push-pull, complementary-symmetry transistors (PNP, NPN).

The electronic protective circuit senses the peak output current and limits the current to the driver transistors at a safe, predetermined value. This current limiting protects the driver and output transistors under overdrive and short circuit conditions and effectively prevents the driver and output transistors from exceeding safe operating conditions. This instantaneous acting safety circuit gives constant and unobtrusive protection without causing annoying program interruptions. For added safety, a relay speaker protection circuit (patent applied for) automatically disconnects loudspeakers and headphones in the unlikely event of a failure in the output or driver circuits. Any significant DC voltage on the output terminals will activate the relay.

CAUTION

The loudspeaker terminals of one channel should never be connected directly in parallel with any other. Any resulting damage is not covered under the warranty.

speaker systems switch The Speaker Systems switch selects either the MAIN or the REMOTE pair of loudspeakers individually, or BOTH systems may be selected simultaneously. When BOTH systems are selected the loudspeakers in each channel are connected in parallel. When two pairs of 4-ohm loudspeakers are used in parallel (2-ohms resultant impedance) the Eighteen will deliver approximately half of its 4-ohm power into this 2-ohm load. When the speaker systems switch is rotated to the OFF position, all loudspeaker terminals are disconnected from the power output stage. The STEREOPHONES jack, however, is unaffected by the speaker systems switch.

TECHNICAL SPECIFICATIONS

AUDIO CIRCUITS:

Rated continuous (RMS) power output per channel, both channels operating simultaneously, 20 Hz to 20,000 Hz	40 Watts at 4 and 8 ohms 20 Watts at 16 ohms
High-level hum and noise (ref. 40W at 8 ohms)	-80 dB
Phono hum and noise	1 μ V equivalent input*
Dynamic range (phono input to tape recording output)	98 dB Minimum
I.M. Distortion (SMPTE), at rated power	0.2% Maximum
Distortion decreases as output is lowered	
Total Harmonic Distortion, at rated power	0.2% Maximum
Distortion decreases as output is lowered	
Power Bandwidth (IHF) for 0.2% THD	10 Hz to 30,000 Hz
Damping Factor (ref. 8 ohms)	30 Minimum
Frequency Response	
High-level 20 Hz to 20,000 Hz	\pm 0.5 dB
RIAA Phono Equalization	\pm 0.5 dB
Input Sensitivity (for 40W at 8 ohms)	
High-level	100 mV
Phono (1,000 Hz)	1 mV
Input Impedance	
High-level	100,000 ohms
Phono	47,000 ohms
Channel Separation 20 Hz to 20,000 Hz	35 dB Minimum
Stability	Unconditional

*Measured (with input shorted) through an audio bandpass filter -3 dB at 20 Hz and 20,000 Hz with 12 dB/octave cutoff slopes. The equivalent input noise figure allows a true calculation of phono signal/audio-noise ratio without the inclusion of errors resulting from arbitrary signal level inputs (which frequently are chosen to optimize the S/N ratio). For example, a phono signal of 5 mV (5,000 μ V/1 μ V) results in a 74 dB signal/noise ratio.

TECHNICAL SPECIFICATIONS

FM SECTION:

IHF Usable Sensitivity	2.8 μ V
Noise Quieting	—50 dB at 5 μ V
	—60 dB at 10 μ V
	—70 dB at 50 μ V
Total Harmonic Distortion, 400 Hz, 100% Mod.	0.2% Maximum
Frequency Response (ref. 75 μ sec. de-emphasis)	\pm 0.5 dB
Multiplex Separation	1,000 Hz 45 dB Minimum
	20 Hz 40 dB Minimum
	10,000 Hz 35 dB Minimum
	15,000 Hz 30 dB Minimum
Sub-Carrier (38 kHz) Suppression	60 dB Minimum
SCA Pilot Carrier (67 kHz) Suppression	65 dB Minimum

GENERAL:

Power Requirements	105 to 125 VAC
	50 to 60 Hz
At rated output, both channels operating	250 Watts
Idling Power (Volume Control at zero)	70 Watts
Overall Dimensions (including feet):	18 $\frac{1}{4}$ Wide x 6 High x 16 Deep
Front Panel Dimensions:	18 $\frac{1}{4}$ Wide x 5 $\frac{3}{4}$ High
Shipping Weight:	46 Pounds
Optional Cabinet (B18-O) Shipping Weight	11 Pounds
Dimensions When Mounted in Accessory Cabinet:	19 Wide x 6 $\frac{3}{4}$ High x 16 Deep

Specifications subject to change without notice.

SERVICE NOTES

FUSE

The Model Eighteen is protected by a 2½ amp, slow-blow fuse. In the event the fuse blows out, replace **ONLY** with the same type and rating. Replacement with a fuse of higher rating will not protect the instrument and will void the warranty.

KNOBS

The round knobs on the front panel are held to their shafts by #6 Allen-head setscrews. An Allen wrench has been included in the Parts Kit envelope for use in removing or tightening these knobs. Each **CENTERING** knob is a "push-on" type and is secured by built-in spring action.

CLEANING

Your Model Eighteen Receiver has a very durable finish. The front panel is finished with epoxy paint and the inserts and knobs are gold anodized for lasting beauty. You can clean the panel and knobs with a mild detergent and water solution applied with a soft cloth or cotton swab. Never use scouring powder or any strong chemical cleaner.

REPAIRS

Only the most competent and qualified service technicians should be allowed to service the Eighteen Receiver. The Marantz Company and its warranty station personnel have the knowledge and special equipment needed for repair and calibration of this precision instrument.

In the event of difficulty, write directly to the factory (to the attention of the **SERVICE MANAGER**) for the name and address of the Marantz warranty or authorized service station nearest your business or home. Please include the model and serial number of your unit together with a description of what you feel is abnormal about its behavior.

If it should ever be necessary to ship your unit to the factory or authorized service station, **ALWAYS REMOVE THE RECEIVER FROM ITS CABINET. DO NOT SHIP THE CABINET.** Pack the unit carefully using the original packing material. If the packing material has been discarded, lost or damaged, write to the factory (to the attention of the **SERVICE MANAGER**) for new packing material. Carton, fillers, and packing instructions will be shipped to you at a nominal charge.

No receiver should be returned to the factory without an Authorized Return Label which Marantz Company will send to you if your description of difficulties appears to warrant factory service.

REPLACING DIAL-GLASS LAMPS

An extra lamp has been included in the Parts Kit envelope packed with the unit.

Dial-glass illumination of the Model Eighteen is provided by two #1847 lamps (one on each side) behind the panel. These long-life bulbs should not require replacement for years. When replacement is necessary, removal of

the front panel and knobs is required, as follows:

- Step 1.** Rotate the **balance**, **bass**, and **treble** controls fully counter-clockwise. Affix a piece of masking tape to the panel adjacent to each of these knobs and mark the position of each of the five pointers. (After the knobs have been removed, these markings will allow the knobs to be replaced at the exact positions which give electrically balanced and flat response when these controls are rotated to mid-position.)
- Step 2.** Using the #6 hex socket (Allen) wrench provided in the Parts Kit, remove the eight aluminum control knobs. Remove the two **CENTERING** knobs by pulling straight out.
- Step 3.** Remove the hex nuts which hold the panel to the controls. Remove the three screws holding the top cover to the front panel. Remove panel by pulling forward over control shafts.
- Step 4.** Remove the black tape at the edge of the glass. Remove the socket mounting screw and the plastic light shield. Replace the lamp and the plastic light shield and re-mount the socket. Adjust the socket so that the hole in the

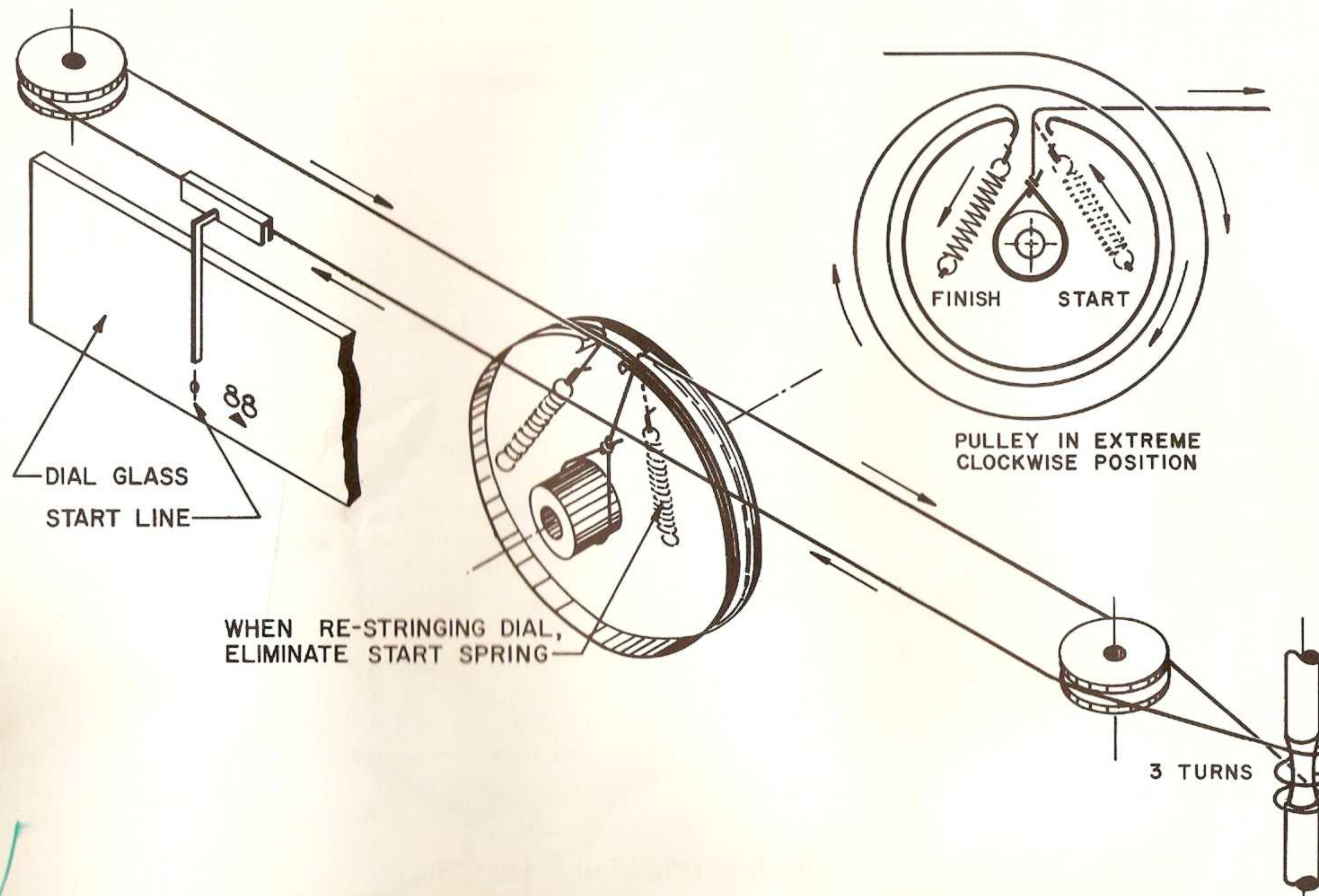

Figure 17. Dial-Stringing Diagram

light shield is aligned with the edge of the dial-glass at the lower corner. Replace the tape. Any opaque, black tape may be used for this purpose.

Step 5. Reverse the procedure to re-assemble the front panel and knobs.

RE-STRINGING DIAL CORD

The dial string used in the model Eighteen

is a long-life, polyester (dacron) cord and should not require replacement for many years. If replacement is ever necessary, remove the top cover (12 screws) and re-string the dial drive assembly as shown in Figure 17.

*
marantz
 37-04 57th STREET, WOODSIDE, NEW YORK, 11377

CAUTIONS

Please **DO NOT** ship receiver mounted in its cabinet.
 Insure receiver for full value.
 Make sure that your correct return address is on shipping label.
 Ship via a reputable carrier. **DO NOT USE PARCEL POST—BE SURE TO OBTAIN RECEIPT FROM CARRIER.**

PACKING INSTRUCTIONS FOR MARANTZ
 MODEL 18 RECEIVER

1. Place bottom cushion (A) into inner carton (B).
2. Insert bottom filler (C) and center it. **Note its orientation.**
3. Place receiver (D) into carton. **Make sure that bottom filler (C) fits between the feet of the receiver.** Slide receiver backward to allow space for front panel cushions (E).
4. Insert one of the front panel cushions (E) and press flat against panel. **Note orientation of cushion for correct fit.** Insert second cushion (E) by sliding between carton wall and first panel cushion, then pull receiver forward. Fold line-cord hank (F) UP toward center at rear of unit.
5. Insert two rear corner cushions (G), then top cushion (A). **Note orientation of top cushion (A).**
6. Place packed inner carton (B) in outer carton (H).
7. Insert four corner cushions (J).
8. Seal inner carton, and outer carton with strong tape.

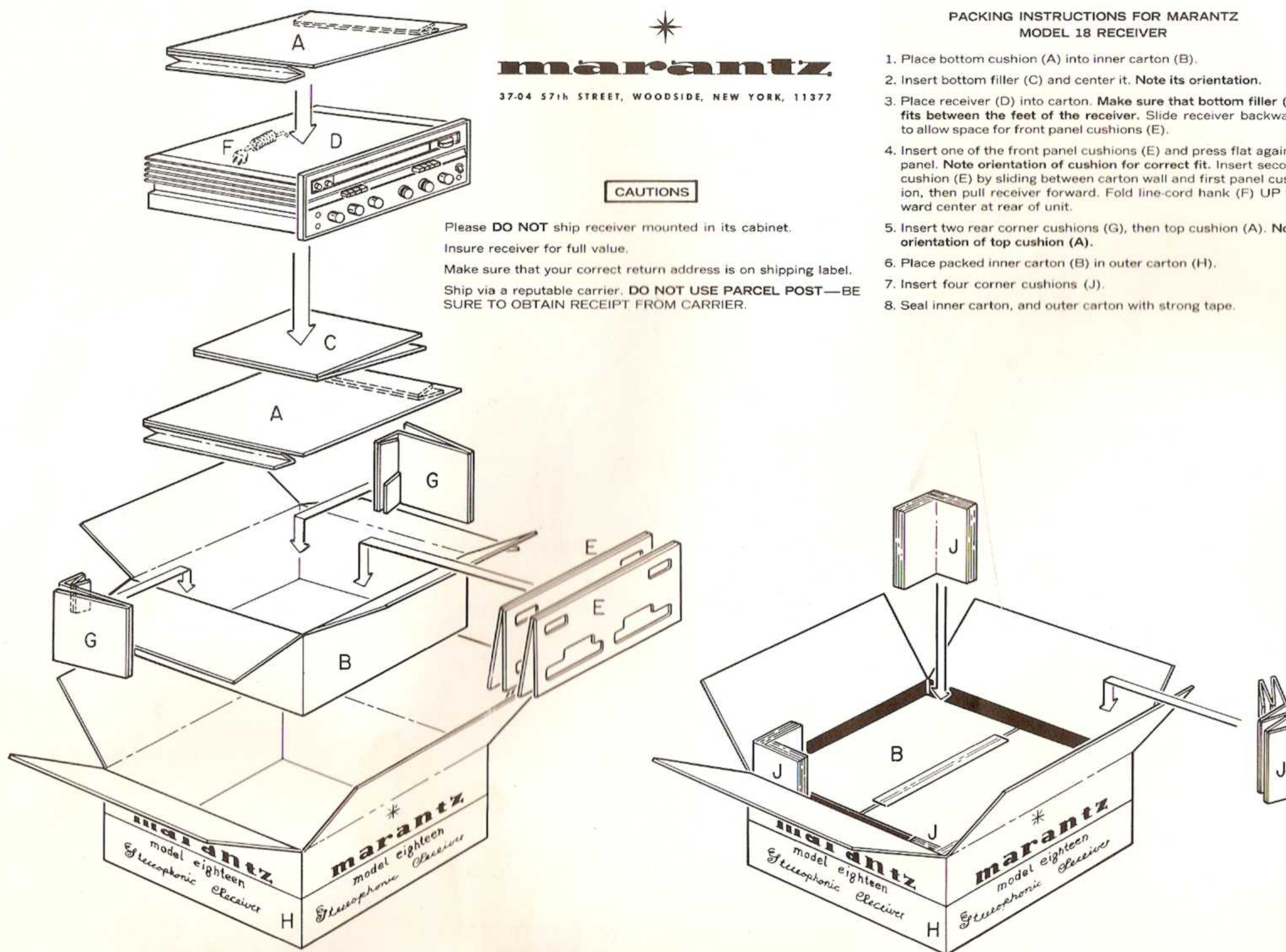

Figure 18. Packing Instructions



marantz

37-04 57th STREET, WOODSIDE, NEW YORK, 11377

A SUBSIDIARY OF SUPERSCOPE, INCORPORATED