

PRINTED CIRCUIT BOARD (Pattern side)

Note) 文字面 : Component side

Main Circuit Board (1)

Note) * marked

	U, C	R, A
R351	4.7	SHORT
R352	1K	SHORT

SW101
PHONO

MM
MC

TO : MAIN (2)
TO : MAIN (2)

TO : MAIN (11)
TO : MAIN (4)
TO : MAIN (6)

FROM : MAIN (3)
TO : MAIN (3)

FROM : MAIN (3)

(R Model Only)
FROM : MAIN (8)

(R Model Only)
FROM : POWER
TRANSFORMER

FROM :
POWER
TRANSFORMER

TO : MAIN (7)

FROM : POWER
TRANSFORMER

FROM : MAIN (9)

TO : MAIN (9)

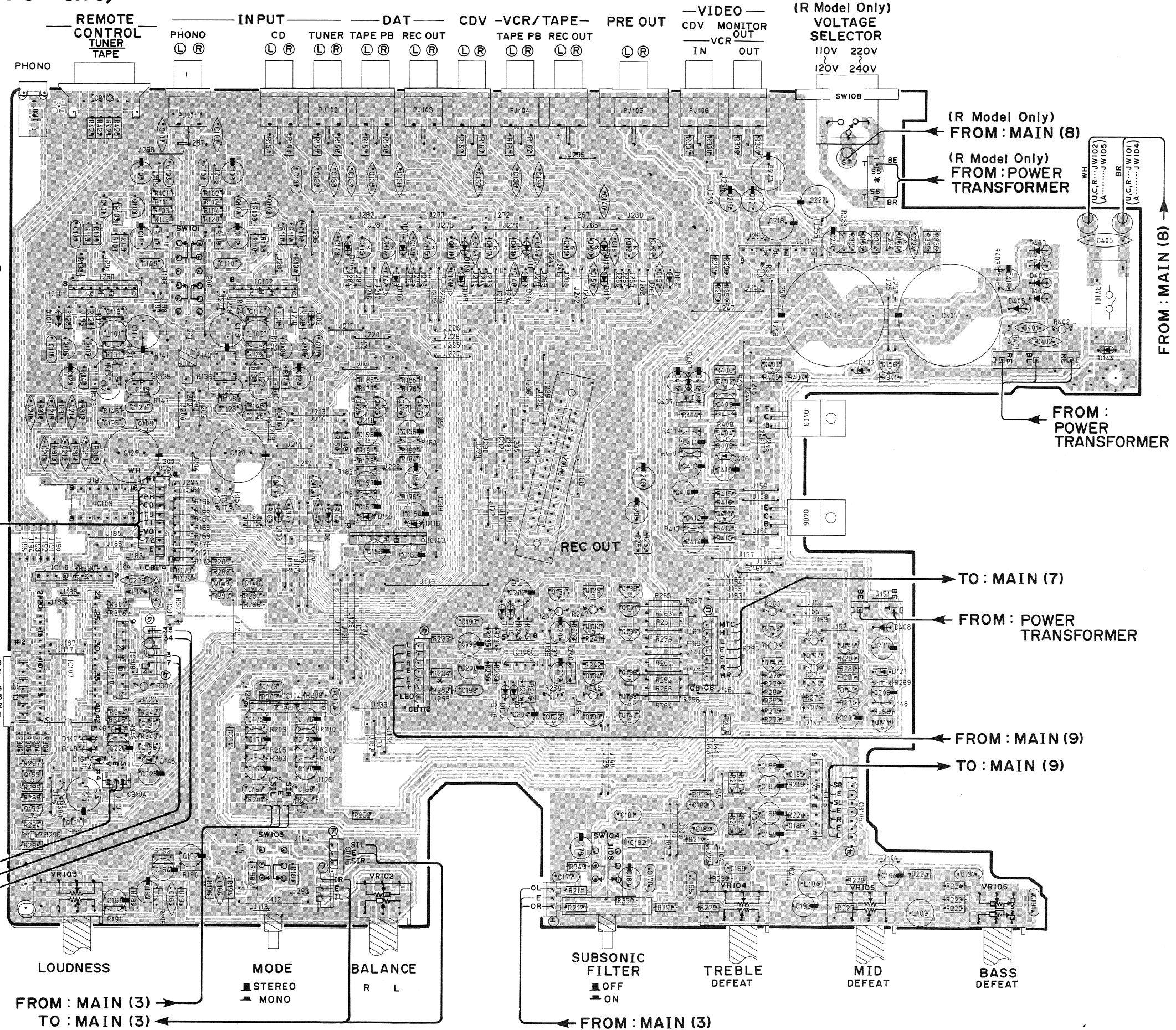

1
2
3
4
5
6

PRINTED CIRCUIT BOARD (Pattern side)

Main Circuit Board (2)

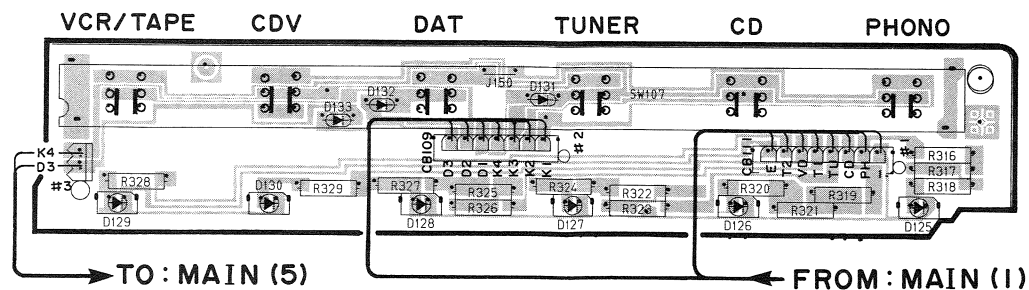

Main Circuit Board (11)

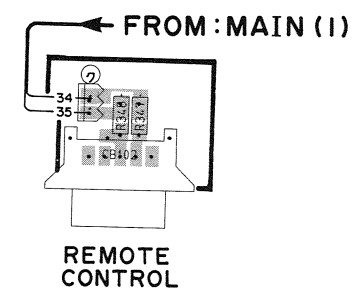

Main Circuit Board (5)

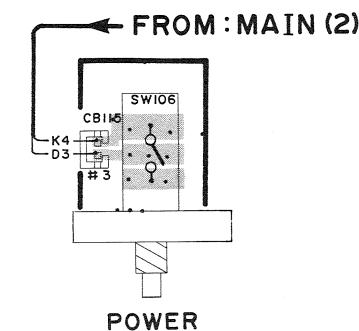

Main Circuit Board (6)

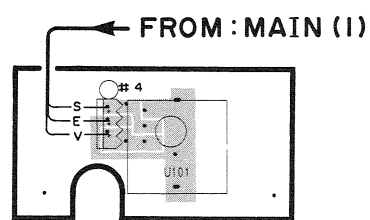

Main Circuit Board (10)

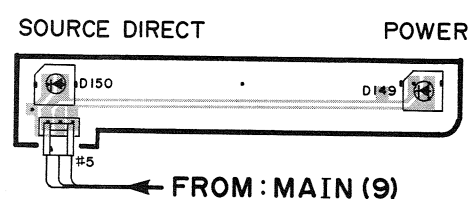

Main Circuit Board (4)

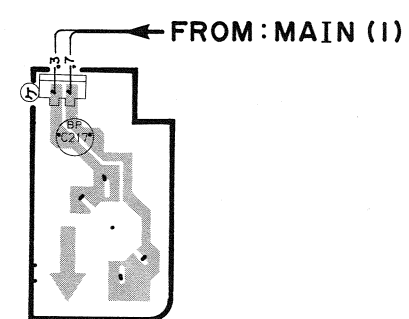

U,C,R MODELS

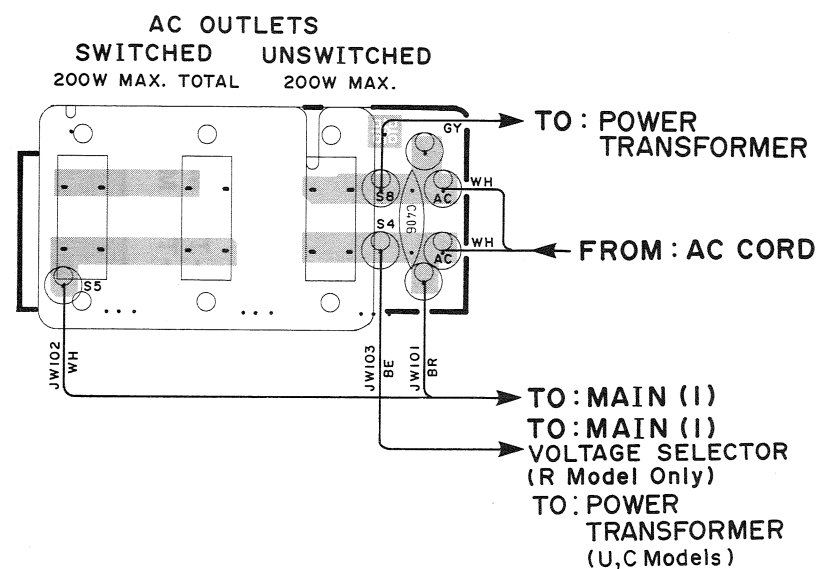

Main Circuit Board (7)

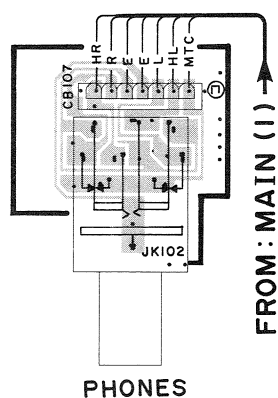

Main Circuit Board (9)

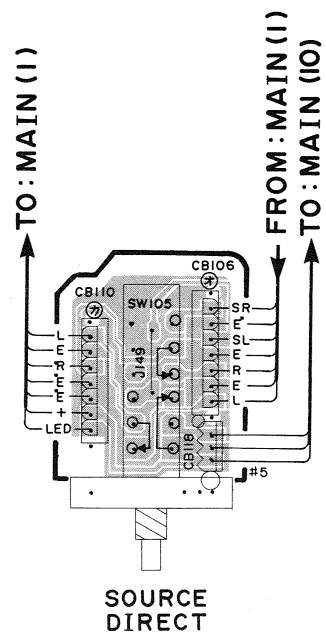

Main Circuit Board (3)

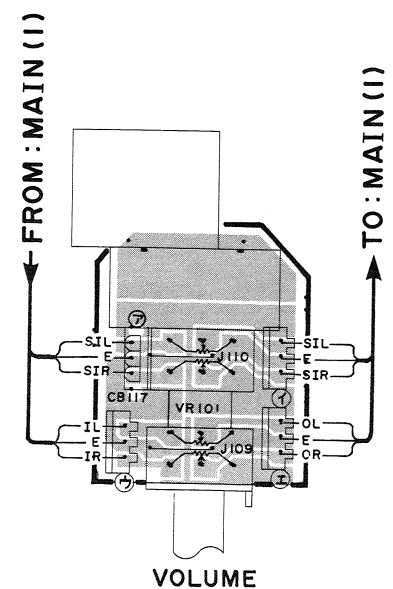

A MODEL

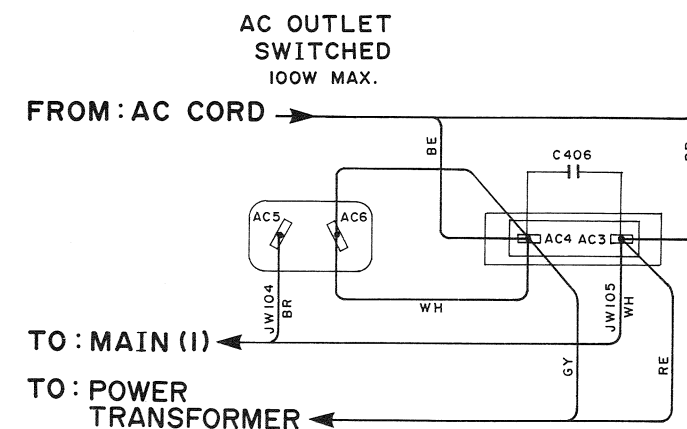

1

2

3

4

5

6