

SERVICE MANUAL

CR-600

CONTENTS

FEATURES	2
NEW PARTS	2
CIRCUIT DESCRIPTION	5
SPECIFICATIONS	6
EXTERNAL VIEW	
FRONT PANEL	8
REAR PANEL (GENERAL)	8
REAR PANEL (EUROPEAN MODEL)	8
INTERNAL VIEW	
TOP VIEW	10
BOTTOM VIEW	11
PARTIAL DISASSEMBLY	
CABINET REMOVAL	12
FRONT PANEL REMOVAL	12
REAR PANEL REMOVAL	13
SUB CHASSIS TILTING	13
PRE AMP CIRCUIT BOARD REMOVAL	14
FUNCTION CIRCUIT BOARD REMOVAL	14
POWER SWITCH REMOVAL	14
TUNING & SIGNAL METER REMOVAL	15
POWER CIRCUIT BOARD REMOVAL	15
EQ. AMP CIRCUIT BOARD REMOVAL	15
MAIN AMP CIRCUIT BOARD REMOVAL	16
TUNER CIRCUIT BOARD REMOVAL	16
DIAL MECHANISM	17
MEASUREMENT AND ADJUSTMENT	18
BLOCK DIAGRAM	31
PARTIAL CHANGES MADE ACCORDING TO DESTINATION	32
OVERALL SCHEMATIC DIAGRAM	33
PRINTED CIRCUIT BOARD & SPECIAL REPLACEMENT PARTS LISTS	
TUNER CIRCUIT BOARD	35
EQ. AMP CIRCUIT BOARD	37
8P PIN JACK CIRCUIT BOARD	37
PRE AMP CIRCUIT BOARD	38
MAIN AMP CIRCUIT BOARD	40
POWER CIRCUIT BOARD	42
6P PIN JACK CIRCUIT BOARD	43
LIGHT EMITTING DIODE CIRCUIT BOARD	44
COUPLER CIRCUIT BOARD	44
FUNCTION CIRCUIT BOARD	45
DIN CONNECTOR CIRCUIT BOARD (EUROPEAN MODEL ONLY)	46
PARTS CATALOG	47

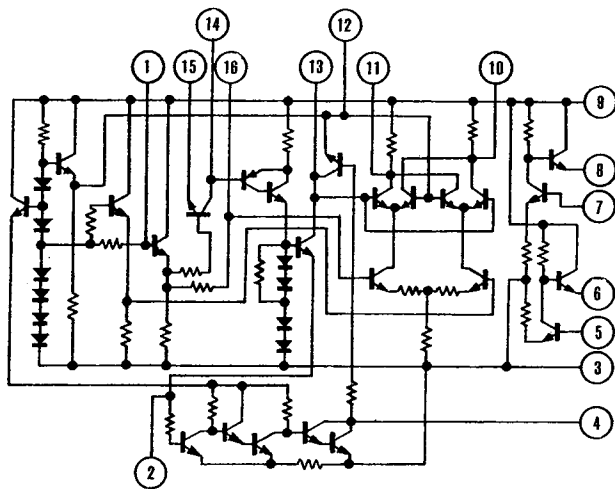

Note:

1. Do not wet ICs with water or other conductive liquies.
2. Do not leave ICs in heat or oxidizing atmosferes for long periods.
3. Avoid using testers to check ICs for serviceability.
4. When soldering an IC with A regular soldering iron, work as first as possible, try to finish within at most four seconds.
For best safety, use a special IC soldering iron.

c. Name : TA-7122P
Function : EQ amp.

ABSOLUTE MAXI- MUM RATINGS (Ta = 25°C)	Vcc	Icc	Tstg	Topr
	42V	8mA	-30~ +75°C	-55~ +125°C

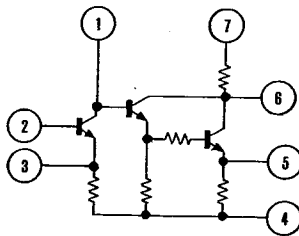
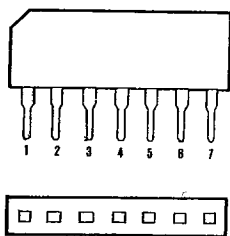

Tstg : Upper and lower limit values of the ambient temperature which must not be surpassed when the transistor out of operation is kept in storage.

Topr : Limit value of the ambient temperature at which operation is possible under the prescribed heat radiation conditions.

Vcc : Maximum collector voltage.

Icc : Maximum collector current.

IL : Current to drive the Lamp.

CIRCUIT DESCRIPTION

MUTING CIRCUIT

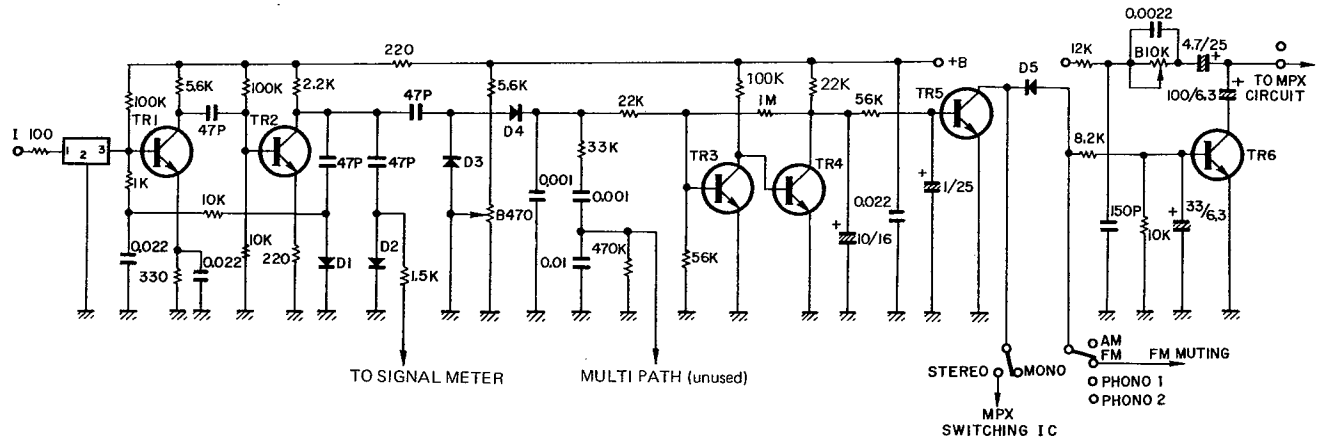

1. When no signal is received during FM mode (or if the received signal is very weak), Tr3 is OFF, Tr4 is ON and Tr5 is OFF due to a lack of signal received at the I terminal. +B electric potential is fed to the Tr6 base, so that Tr6 goes ON. The FM signal is shorted to the ground, and there is output power at O terminal, and no noise between broadcasting stations.

2. When signals are received during FM mode they enter through the terminals and are amplified by Tr1 and Tr2, rectified by D3 and D4, and then fed to the base of Tr3. This switches Tr3 ON and Tr4 OFF. Because of this, +B potential is fed to the base of Tr5, switching Tr5 ON. The same +B potential fed to the base of Tr6 shorts it and switches it OFF, so that output power appears at the O terminal.

AUTO TOUCH AFC OFF

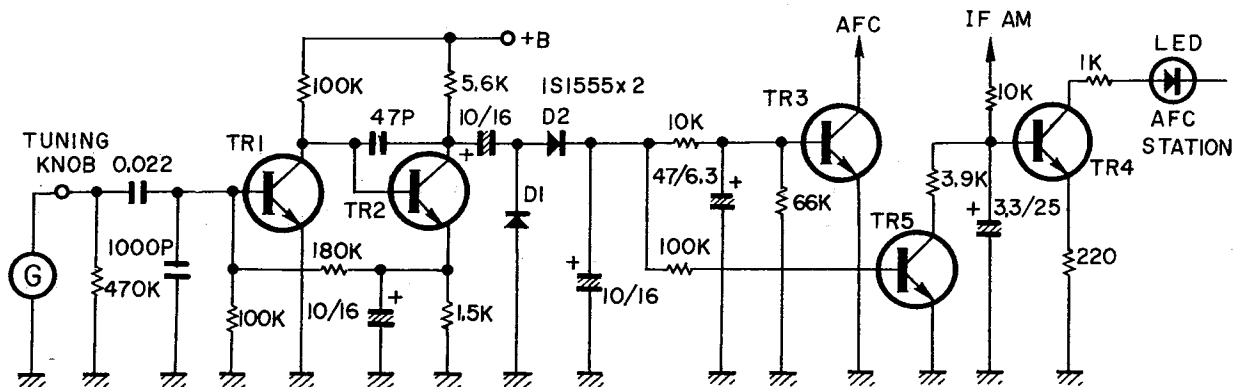

1. Touch the Tuning knob.
 2. The body's electric potential is amplified by Tr1 and TR2.
 3. D1 and D2 rectify the Tr2 output voltage to get DC voltage.

4. This DC voltage is fed to Tr3, which switches it ON, then the AFC signal is shorted.
 5. At the same time, this DC voltage rapidly lowers the Tr5 impedance, thus reducing the Tr4 base potential. It also lowers the LED brightness.

SPECIFICATIONS

■ **AUDIO SECTION**

POWER OUTPUT

Dynamic Power
 (IHF) 130 watts (4Ω)
 90 watts (8Ω)
 Continuous RMS Power (each channel driven)
 45/45 watts (4Ω) at 1,000Hz
 35/35 watts (8Ω) at 1,000Hz
 Continuous RMS Power (both channels driven)
 40 + 40 watts (4Ω) at 1,000Hz
 32 + 32 watts (8Ω) at 1,000Hz
 Continuous RMS Power (both channels driven)
 35 + 35 watts (4Ω) at 20 to 20,000Hz
 30 + 30 watts (8Ω) at 20 to 20,000Hz

TOTAL HARMONIC DISTORTION

Power Amplifier Only
 less than 0.1% at rated power
 less than 0.04% at 1 watt
 Preampifier Only (PHONO to PRE OUT)
 less than 0.1% at rated power
 (AUX to PRE OUT)
 less than 0.02% at rated power
 Overall (AUX to Power Output)
 less than 0.1% at rated power

INTERMODULATION DISTORTION

(70Hz : 7,000Hz = 4:1 SMPTE method)
 Power Amplifier Only
 less than 0.1% (8Ω) at rated power
 less than 0.05% (8Ω) at 1 watt
 Overall (AUX to Power Output)
 less than 0.1% (8Ω) at rated output

POWER BANDWIDTH (IHF, distortion 0.5% const.)

5 to 70,000Hz

FREQUENCY RESPONSE (at 1 watt)

Overall (AUX, TAPE PB to Power Output)
 10 to 50,000Hz + 0.5dB, -1dB
 Overall (MIC to Power Output)
 100 to 10,000Hz +0.5dB, -6dB
 Power Amplifier Only
 10 to 100,000Hz +0dB, -1dB
 RIAA Deviation (30 to 15,000Hz)
 +0.5dB, -0.5dB

LOAD IMPEDANCE

4 to 16Ω

DAMPING FACTOR

(8Ω) 70 at 1,000Hz

CHANNEL SEPARATION (at rated power, 1,000Hz)

Power Amplifier Only

60dB
 Overall from PHONO 1, 2
 50dB
 Overall from AUX, TAPE PB
 50 dB
 Overall from MIC 50 dB

HUM AND NOISE (IHF, Closed Circuit A Network)

Overall from PHONO 1, 2
 better than 75dB
 Overall from MIC better than 70dB
 Overall from AUX, TAPE PB
 better than 90dB
 Power Amplifier Only
 better than 100dB

Volume at Minimum

better than 90dB

INPUT SENSITIVITY AND IMPEDANCE

(at rated power, 1,000Hz)

PHONO 1 3mV (50kΩ)
 PHONO 2 3mV (50kΩ)
 PHONO 1, 2 Max. Input Capability
 135mV (T.H.D. 0.1%)
 MIC 3mV (50kΩ)
 MIC Max. Input Capability
 450mV (T.H.D. 0.3%)
 AUX 150mV (45kΩ)
 TAPE PB A, B 150mV (45kΩ)
 Power Amplifier Input
 775mV (45kΩ)

OUTPUT LEVEL AND IMPEDANCE

(at rated power, 1,000Hz)

TAPE REC OUT A, B
 150mV (2kΩ)
 PRE OUT
 775mV (2kΩ)
 3,000mV (Max. Output T.H.D. 0.1%)

TONE CONTROLS

BASS +10dB, -10dB at 50Hz
 TREBLE +10dB, -10dB at 10,000Hz

FILTERS

LOW -3dB at 50Hz (12dB/oct.)
 HIFH -3dB at 8,000Hz (6dB/oct.)

LOUDNESS CONTROL

(Continuous Loudness Volume at Minimum)
 +10dB at 100Hz, +5dB at 10,000Hz

■ TUNER SECTION

FM:

Tuning Range 88 to 108MHz

Usable Sensitivity (IHF)

2.0 μ V

Quieting Slope 55dB at 5 μ V

60dB at 10 μ V

Image Frequency Rejection

90dB

IF Rejection 95dB

Spurious Response Rejection

95dB

AM Rejection 55dB

Capture Ratio 1.5dB

Alternate Channel Selectivity (IHF)

75dB

Signal-to-Noise Ratio

70dB

Total Harmonic Distortion

MONO 0.3% at 400Hz

STEREO 0.5% at 400Hz

Stereo Separation 40dB at 400Hz

28dB at 50 to 10,000Hz

Frequency Response

+1.0dB, -1.0dB at 50 to 10,000Hz

+1.5dB, -3.0dB at 20 to 15,000Hz

Sub-Carrier Suppression

40dB

Muting Override Signal Level

10 μ V

Antenna Impedance

300 Ω balanced

75 Ω unbalanced

IF Out Level and Impedance

400mV/1k Ω

AM:

Tuning Range 525 to 1,605kHz

Usable Sensitivity (IHF)

52dB/m

Signal-to-Noise Ratio

45dB at 80dB/m

Image Frequency Rejection

80dB at 1,000kHz

Selectivity 30dB at 1,000kHz

IF Rejection 60dB at 1,000kHz

Spurious Response Rejection

70dB at 1,000kHz

Total Harmonic Distortion

0.8% at 80dB/m

■ GENERAL

Semiconductors 411Cs; 2 MOS FETs; 59 Transistors;
3 LEDs; 33 Diodes; 3 Zener Diodes

Power Source AC 110, 117, 130, 220 240V,
50/60Hz

POWER CONSUMPTION

Max. 200 watts

Rated 120 watts

AC OUTLETS

Switched 2 (total 200 watts)

Unswitched 2 (total 200 watts)

DIMENSIONS 474mm (18 $\frac{3}{4}$ ") W x 158mm (6 $\frac{1}{4}$ ")-

H x 300mm (11 $\frac{3}{4}$ ") D

WEIGHT

13 kg (28.7 lbs.)

Design and specifications subject to change without notice for improvements.

EXTERNAL VIEW

FRONT PANEL

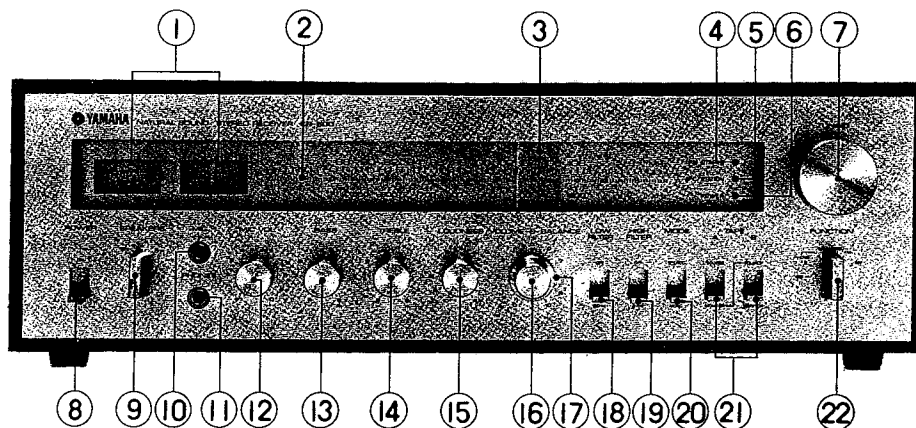

REAR PANEL (GENERAL MODEL)

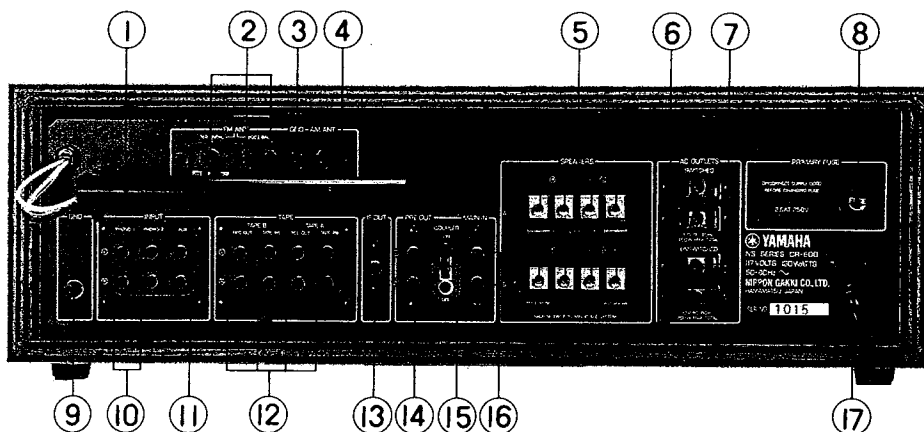

REAR PANEL (EUROPEAN MODEL)

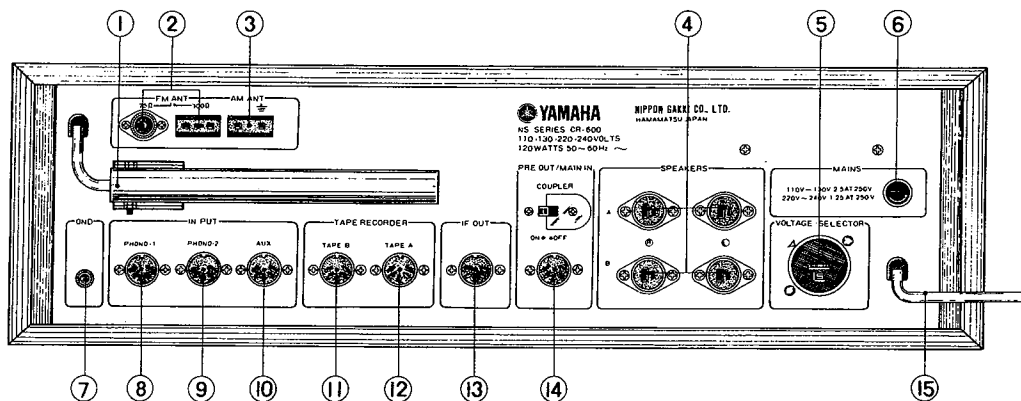

FRONT PANEL

- | | |
|----------------------------|------------------------|
| 1. SIGNAL & TUNING METERS | 12. MIC VOLUME CONTROL |
| 2. DIAL | 13. BASS CONTROL |
| 3. DIAL POINTER | 14. TREBLE CONTROL |
| 4. FM STEREO INDICATOR | 15. LOUDNESS CONTROL |
| 5. AFC/STATION INDICATOR | 16. VOLUME CONTROL |
| 6. POWER INDICATOR | 17. BALANCE CONTROL |
| 7. TUNING KNOB | 18. LOW FILTER SWITCH |
| 8. POWER SWITCH | 19. HIGH FILTER SWITCH |
| 9. SPEAKER SELECTOR SWITCH | 20. MODE SWITCH |
| 10. MIC JACK | 21. TAPE SWITCH |
| 11. HEADPHONE JACK | 22. FUNCTION SWITCH |

REAR PANEL (GENERAL MODELS)

- | | |
|---------------------------|--------------------------------|
| 1. AM FERRITE BAR ANTENNA | 10. PHONO 1, 2 JACKS |
| 2. FM ANTENNA TERMINAL | 11. AUX INPUT JACKS |
| 3. GROUND TERMINAL | 12. TAPE 1, 2 REC OUT/PB JACKS |
| 4. AM ANTENNA TERMINAL | 13. IF OUT JACK |
| 5. SPEAKER TERMINALS | 14. PRE OUT JACKS |
| 6. AC OUTLET (SWITCHED) | 15. COUPLER SWITCH |
| 7. AC OUTLET (UNSWITCHED) | 16. MAIN IN JACKS |
| 8. PRIMARY FUSE | 17. AC CORD |
| 9. GROUND TERMINAL | |

REAR PANEL (EUROPEAN MODEL)

- | | |
|---------------------------|---------------------------------|
| 1. AM FERRITE BAR ANTENNA | 9. PHONO 2 CONNECTOR |
| 2. FM ANTENNA CONNECTOR | 10. AUX CONNECTOR |
| 3. AM ANTENNA CONNECTOR | 11. TAPE B REC OUT/PB CONNECTOR |
| 4. SPEAKER CONNECTORS | 12. TAPE A REC OUT/PB CONNECTOR |
| 5. VOLTAGE SELECTOR | 13. IF OUT CONNECTOR |
| 6. PRIMARY FUSE | 14. PRE OUT, MAIN IN CONNECTOR |
| 7. GROUND TERMINAL | 15. AC CORD |
| 8. PHONO 1 CONNECTOR | |

INTERNAL VIEW

TOP VIEW

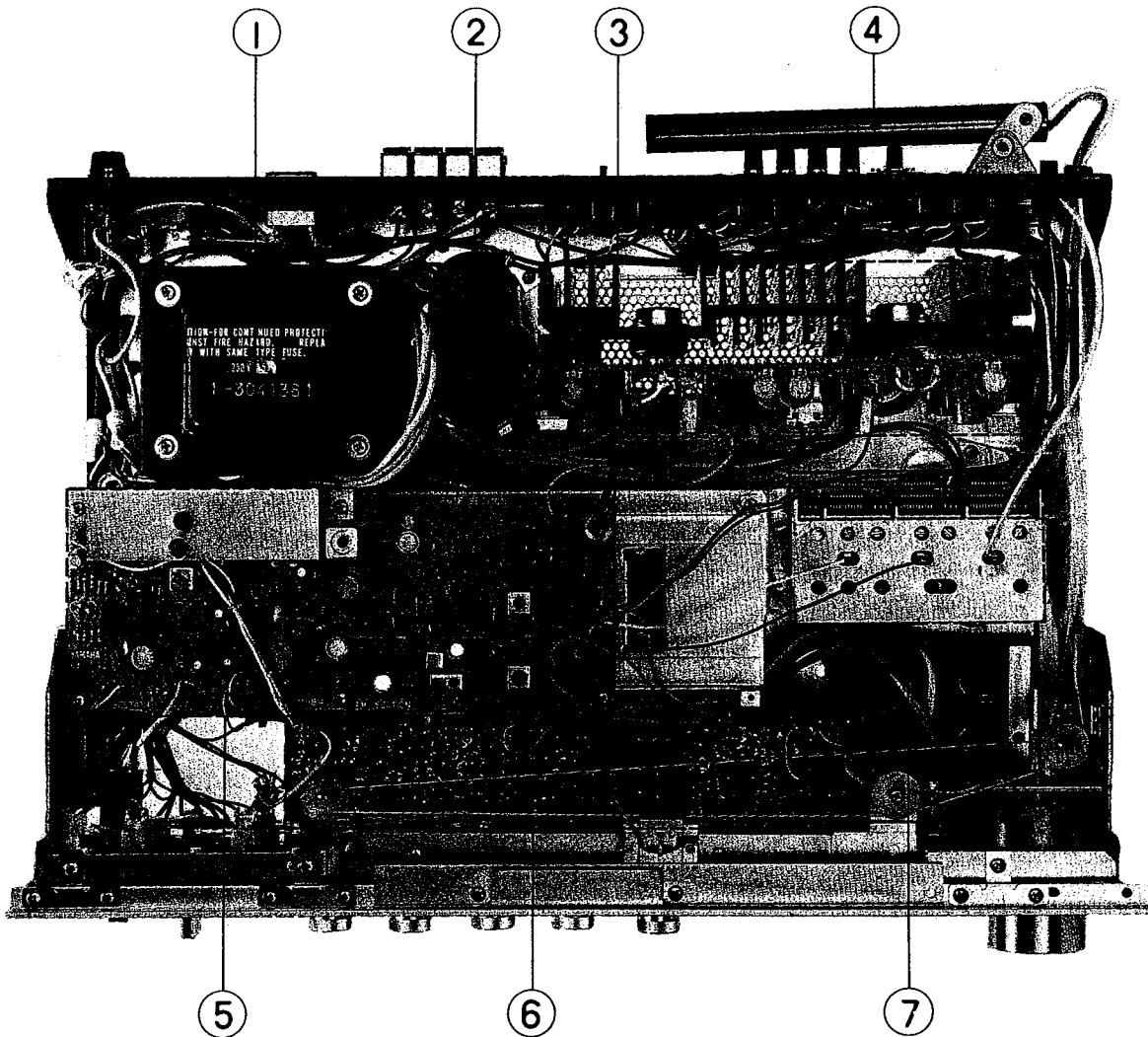

- | | |
|---|------------------------------------|
| 1. POWER TRANSFORMER (GA60563) | 5. TUNER CIRCUIT BOARD (NA06430) |
| 2. ELECTROLYTIC CAPACITOR (4,700 μ F) | 6. PRE AMP CIRCUIT BOARD (NA06434) |
| 3. MAIN AMP CIRCUIT BOARD (NA06427) | 7. FRONT END PACK |
| 4. AM FERRITE BAR ANTENNA | |

BOTTOM VIEW

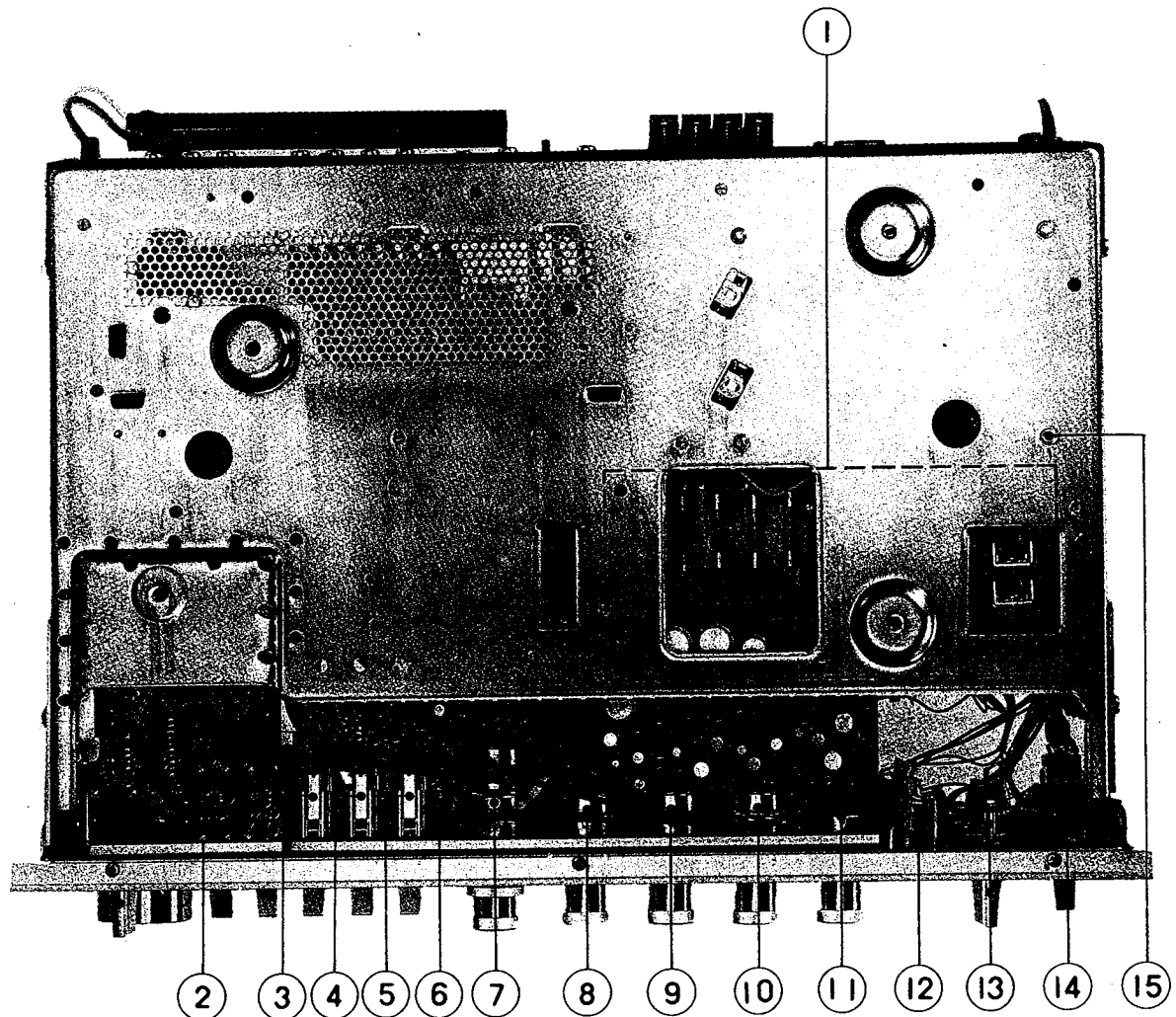

- | | |
|--|---|
| 1. POWER CIRCUIT BOARD (NA06428) | 8. VARIABLE RESISTOR (LOUDNESS CONTROL) |
| 2. FUNCTION CIRCUIT BOARD (NA06435) | 9. VARIABLE RESISTOR (TREBLE CONTROL) |
| 3. MODE SWITCH | 10. VARIABLE RESISTOR (BASS CONTROL) |
| 4. HIGH FILTER SWITCH | 11. VARIABLE RESISTOR (MIC CONTROL) |
| 5. LOW FILTER SWITCH | 12. HEADPHONE JACK |
| 6. PRE AMP CIRCUIT BOARD | 13. SPEAKER SELECTOR SWITCH |
| 7. VARIABLE RESISTOR (VOLUME & BALANCE CONTROLS) | 14. POWER SWITCH |
| | 15. CHASSIS |

PARTIAL DISASSEMBLY

BEFORE DISASSEMBLY

- The screwdriver for each screw should match the screw size. If you use a smaller or larger size it will damage the groove.
- If you use excessive force on the printed circuit board it will crack or cut the print wiring, so be careful.
- When using a soldering iron finish all work as quickly as possible.
- When installing switches and knobs be careful not to install them in the wrong place or upside-down. See Fig. 1.

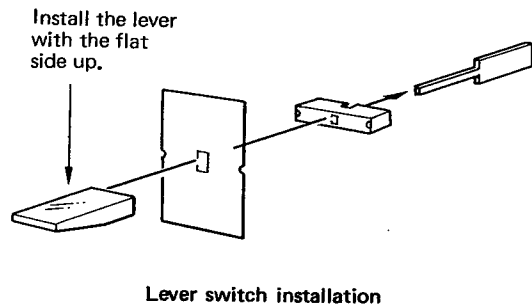

Fig. 1

CABINET REMOVAL

- Stand the main body up and remove screws (1), (2), (3) and (4) (small pan-head screws 5x25) as shown in Photo 1.

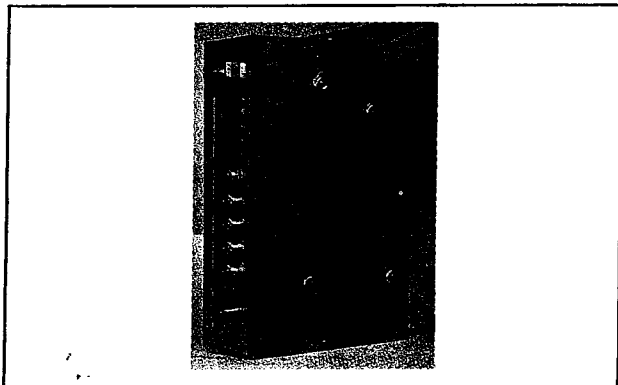

Photo 1

- Set the unit back up and remove the cabinet as shown in Photo 2.

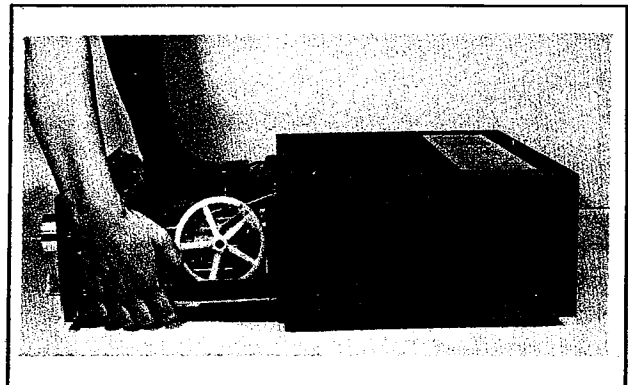

Photo 2

FRONT PANEL REMOVAL

- Remove the Function, Speakers and Tuning knobs using the hexagonal wrench provided (see Fig. 1).
- Pull off the Mic. Vol., Bass, Treble, Loudness and Volume/Balance knobs.
- Remove (1), (2) and (3) screws (bind tapping screws 3x6s) from the top of the front panel as shown in Photo 3, and screws (1), (2) and (3) (small bind screws 3x6s) from the bottom as shown in Photo 4, then remove the front panel by pulling it forward.

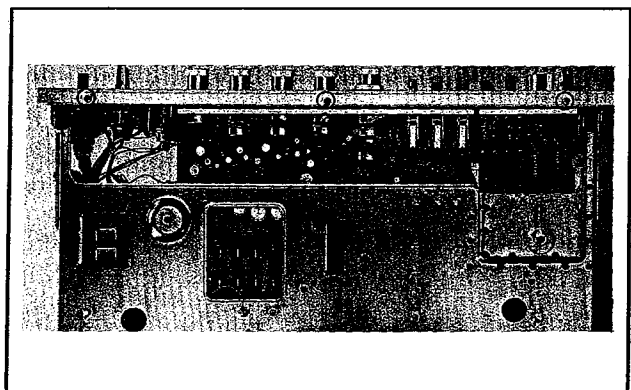

Photo 3

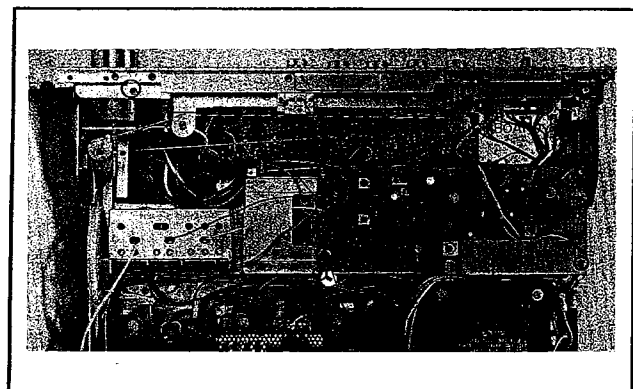

Photo 4

DROPPING THE REAR PANEL CIRCUIT BOARD

a. Pull out the connector as shown in Photo 5.

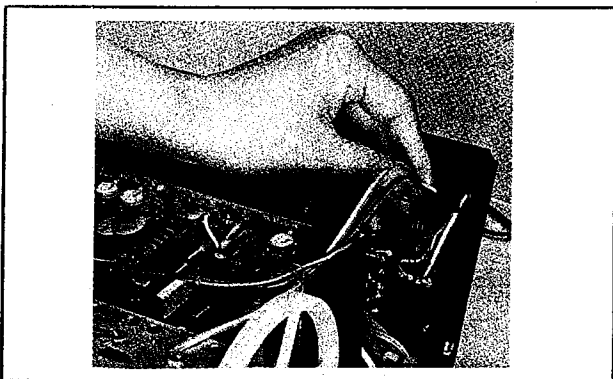

Photo 5

b. Remove the screw in Photo 6 and screws (1) and (2) in Photo 7.

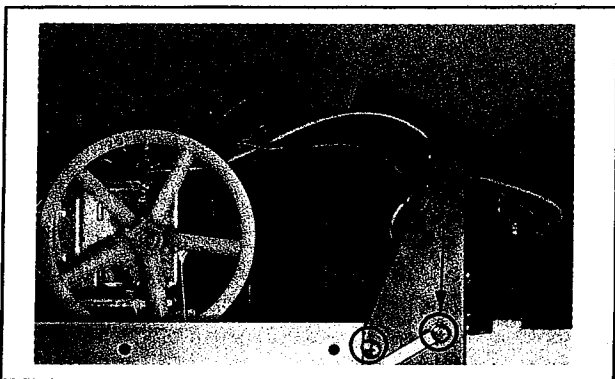

Photo 6

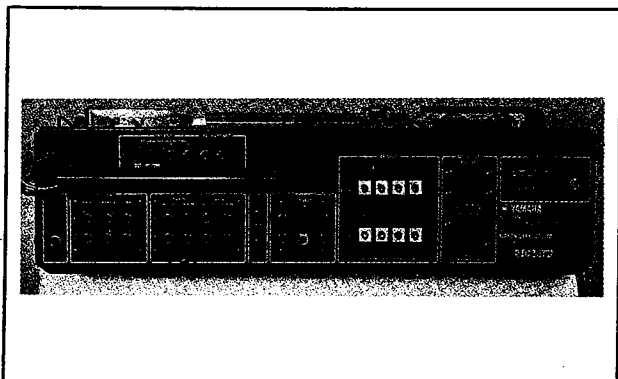

Photo 7

c. Loosen the red-heads screw (1) (plate-head screws 4x8s) shown in Photo 6.

d. Bring the rear panel down as shown in Photo 8.

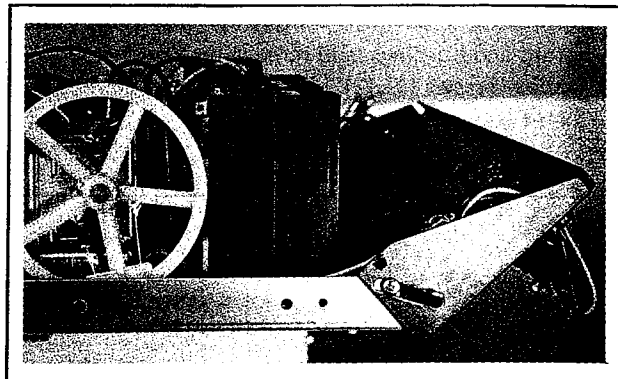

Photo 8

DROPPING THE SUB CHASSIS UNIT

- a. Pull out the rear panel connector (refer to procedure 3).
- b. Remove red-headed screws (1) and (2) and loosen screw (3) (bind tapping screws 4x8s) shown in Photo 9.
- c. Pull the sub chassis unit forward and drop it as shown in Photo 10.

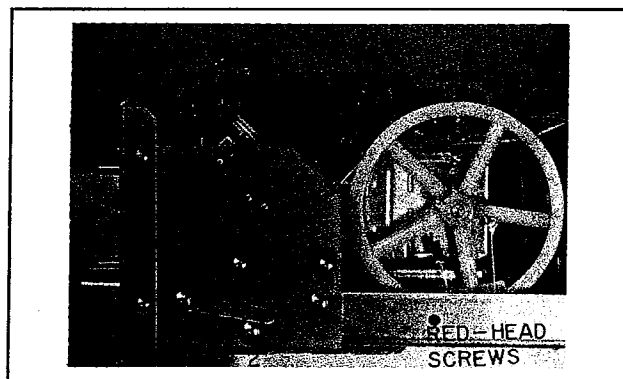

Photo 9

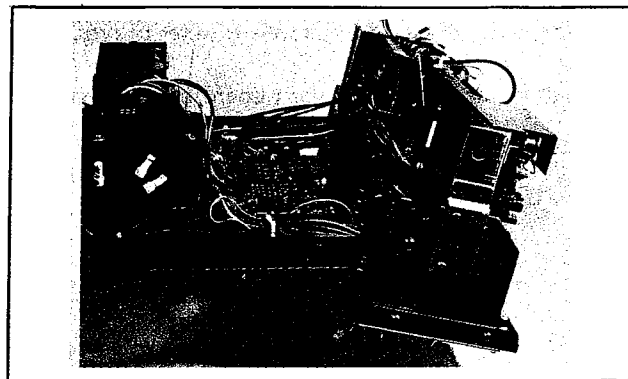

Photo 10

PRE AMP CIRCUIT BOARD REMOVAL

- a. Remove the front panel unit (refer to procedure 2).
- b. Pull off the Low Filter, High Filter and Mode switch aprons and bushings, and remove the switches.
- c. Remove screws (1),(2), (3) and (4) (small bind screws 3x4s) shown in Photo 11.

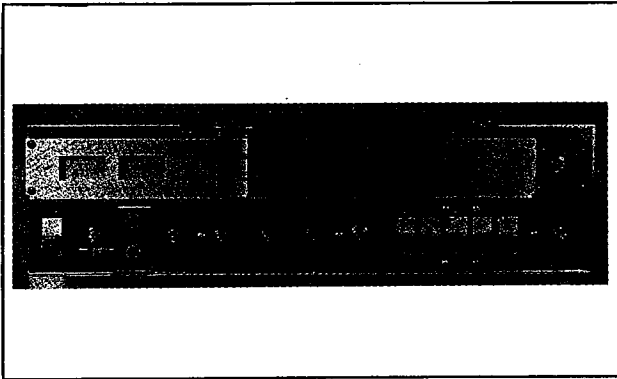

Photo 11

- d. Remove the lead cord connected to the Mic jack with a soldering iron as shown in Photo 12.

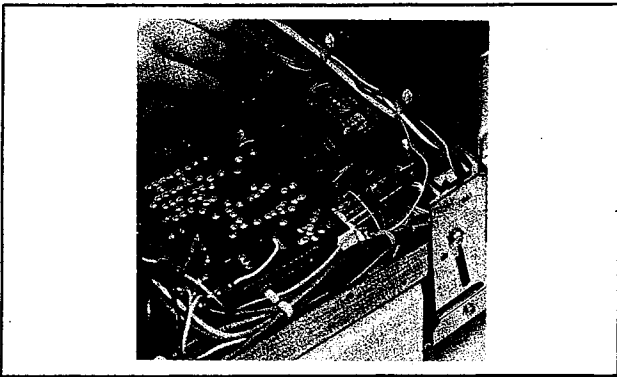

Photo 12

- e. Tilt the sub chassis down forward (refer to procedure 3).
- f. Remove the pre amp circuit board by pulling it up.

FUNCTION CIRCUIT BOARD REMOVAL

- a. Remove the front panel unit (refer to procedure 2).
- b. Pull off the Tape A and B switches, switch aprons and bushings.
- c. Remove screws (1), (2) and (3) shown in Photo 13.

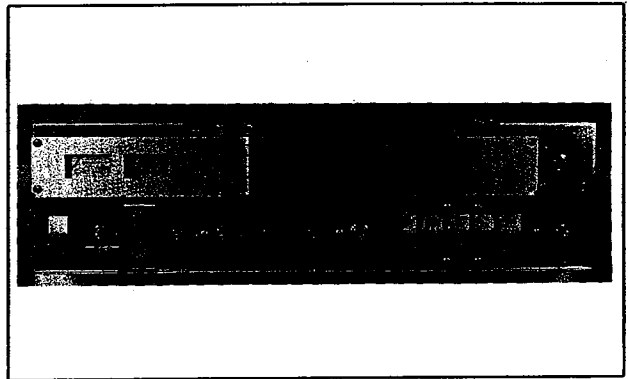

Photo 13

- d. Tilt the sub chassis down forward (refer to procedure 3).
- e. Remove the function circuit board by lifting it up.

POWER SWITCH REMOVAL

- a. Remove the front panel unit (refer to procedure 2).
- b. Pull off the power switch, apron and bushing.
- c. Remove screws (1) and (2) (small bind screws 3x4s) shown in Photo 14.

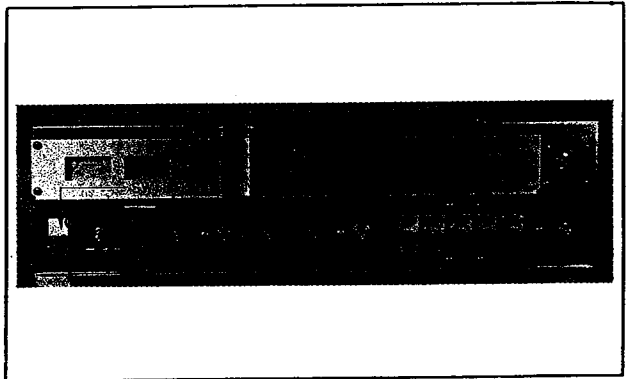

Photo 14

TUNING AND SIGNAL METER REMOVAL

- Tilt the sub chassis unit down forward (refer to procedure 3).
- Pull off the three lead-type lamps with their shade bushings.
- Remove the meter holder spring in Photo 15, as shown in Photo 16, then remove the meter.

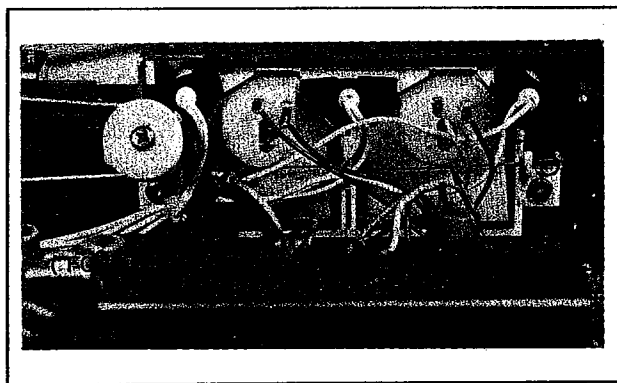

Photo 15

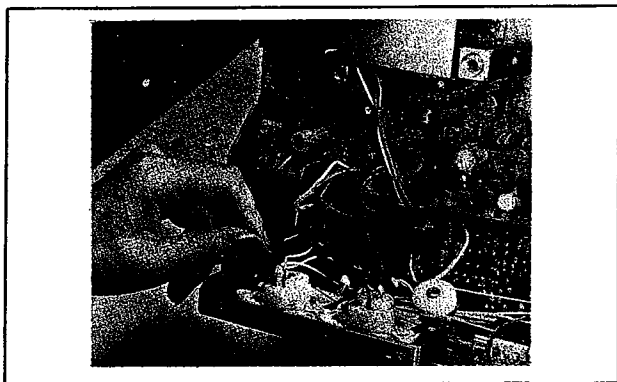

Photo 16

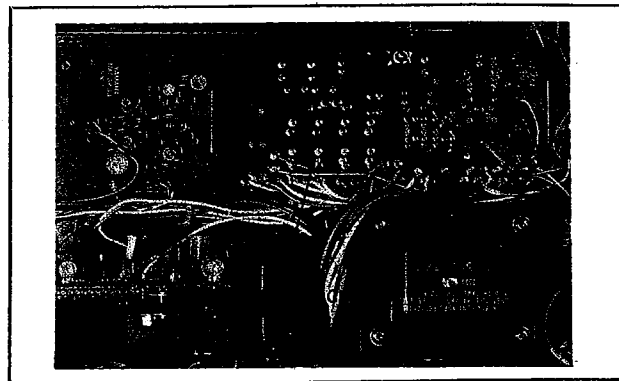

Photo 17

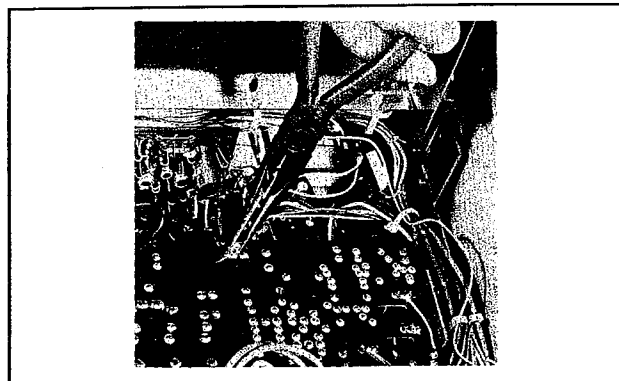

Photo 18

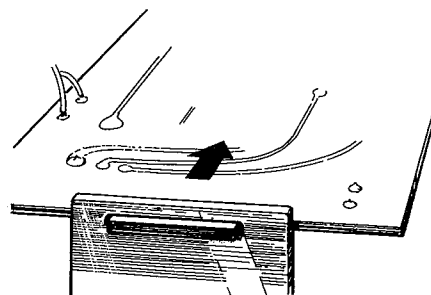

Fig. 2

POWER SUPPLY CIRCUIT BOARD REMOVAL

- Bring the sub chassis unit down forward (refer to procedure 3).
- Hold the three sheet holders shown in Photo 17 with a long-nosed pliers as shown in Photo 18. Pull the power circuit board up and pull it out from the short holder.

Note: If you pull only on the short holder, this will apply excessive force to the board/chassis joint (see Fig. 2). This will probably crack the board.

Be careful to hold the board and pull off the short holder little by little.

- Slide the circuit board in the direction of the arrow to remove it.

EQ CIRCUIT BOARD REMOVAL

- Tilt the sub chassis unit down forward (refer to procedure 3).
- Hold the two short holders shown in Photo 19 with long-nosed pliers and pull the EQ circuit board up to remove it from the short holder (refer to the Note to the left).

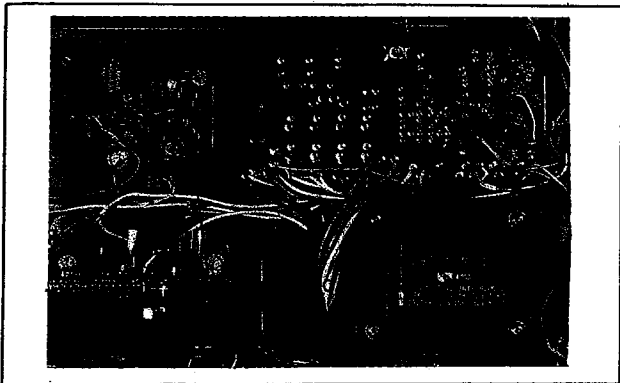

Photo 19

c. Slide the EQ circuit board in the direction of the arrow to remove it.

MAIN AMP. UNIT REMOVAL

a. Remove screws (1) and (2) shown in Photo 20.

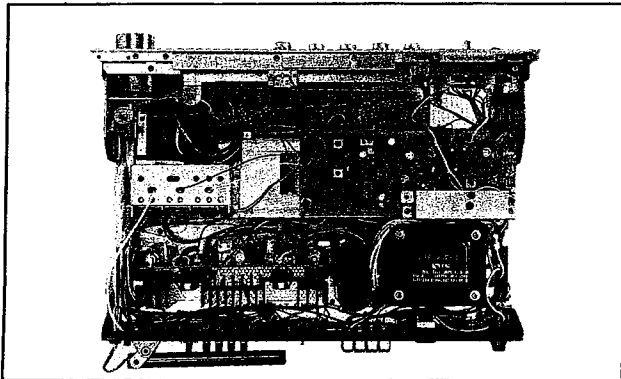





Photo 20

SCREWS

NAME	STYLE	DIMENSION (mm)	
Small Bind Screw		3×4S	Pre-Amp, Function, Front Panel
		3×4S	Power Switch
Small Pan-Head Screw		5×105S	Main Amp
		5×25	Cabinet
Bind Tapping Screw		3×6S	Rear Panel, Front Panel, FM Shield
		4×8S	Sub-Chassis
Plate-Head Tapping Screw		4×8S	Sub-Chassis

- b. Remove the main amp. circuit board by pulling up.
- c. Bring the rear panel down for power transistor change and adjustment (refer to P13).

TUNER CIRCUIT BOARD REMOVAL

- a. Remove screws (1) and (2) (bind tapping screws 3x6s) shown in Photo 21, and remove the FM shield cover.
- b. Pull out the pin jack shown in Photo 21.
- c. Remove screws (1), (2), (3) and (4) (bind tapping screws 3x6s) shown in Photo 21.

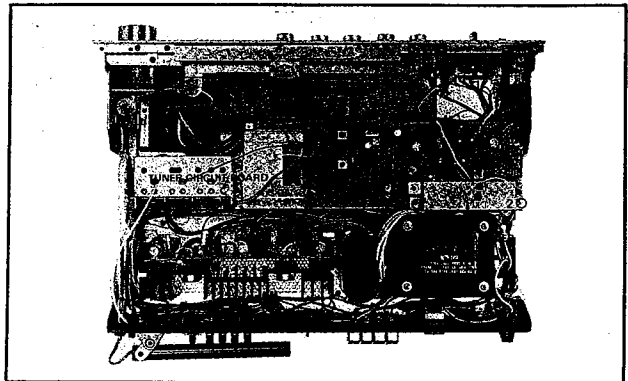
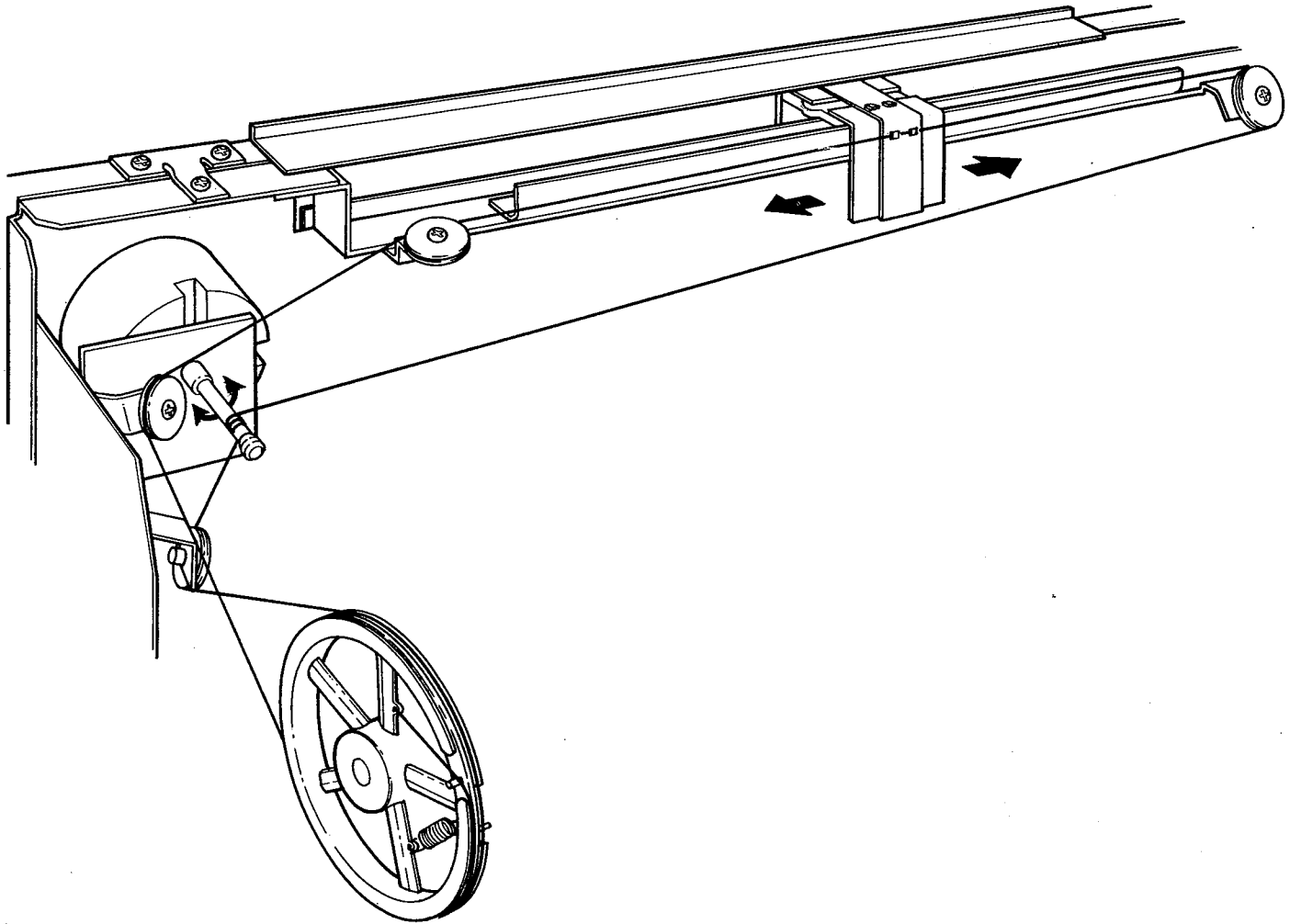

Photo 21

d. Pull up the tuner circuit board to remove it.

DIAL MECHANISM



MEASUREMENT AND ADJUSTMENT

TUNER CIRCUIT BOARD

FM IF ADJUSTMENT

STEP	ALIGNMENT ITEM	TERMINALS TO BE CONNECTED	INSTRUMENT REQUIRED	ADJUST	HOW TO ADJUST	RATING OR STANDARD	REMARKS
1	S-Curve	Input power connector IO-E terminal	Sweep Generator Output power: 40dB Impedance: $400 \pm 100 \Omega$ Oscilloscope Refer to Fig.1.	T101 discrim coil (top and bottom) core, primary and secondary side	Adjust for symmetrical S curve with the secondary-side (upper) core. Adjust for max. height with the primary-side (lower) core. Refer to Figs. 2, 3.	Output voltage: More than 400mVp-p Intermediate frequency: within 10.7Hz ± 200 MHz Bandwidth: More than 300kHz	When T101 is GE6019 When it is GE6019

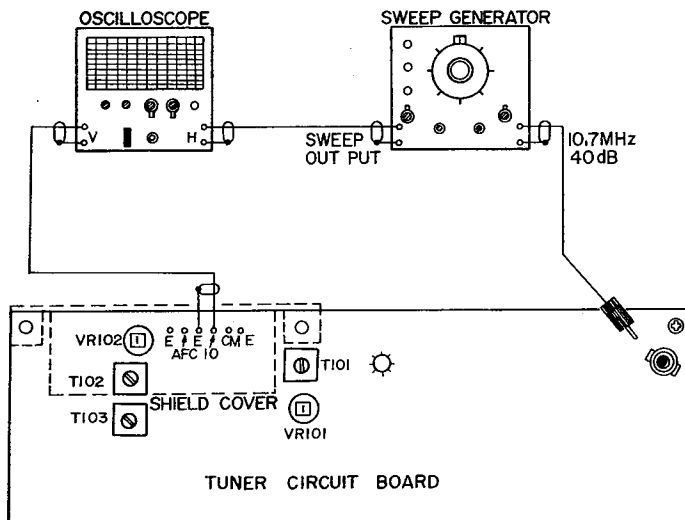

Fig.1

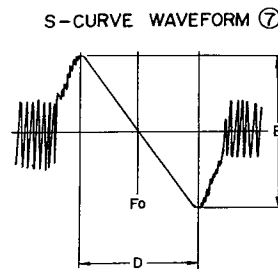

Fig.2

SOUTH AFRICAN MODEL ONLY
(GE6025:T101)

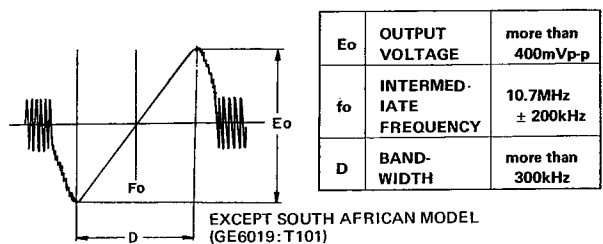

Fig.3

EXCEPT SOUTH AFRICAN MODEL
(GE6019:T101)

AM IF ADJUSTMENT

STEP	ALIGNMENT ITEM	TERMINALS TO BE CONNECTED	INSTRUMENT REQUIRED	ADJUST	HOW TO ADJUST	RATING OR STANDARD	REMARKS
1	V- Curve	TP2-E terminal TP3-E terminal SM-E terminal	Sweep generator Oscilloscope	CF105 T106	Adjust for a curve like that in Fig.5.	Output voltage: More than 500mV Intermediate frequency: Within 455kHz ± 10kHz Bandwidth: More than 5kHz Note: Intermediate frequency in South Africa is 470 ± 10kHz)	

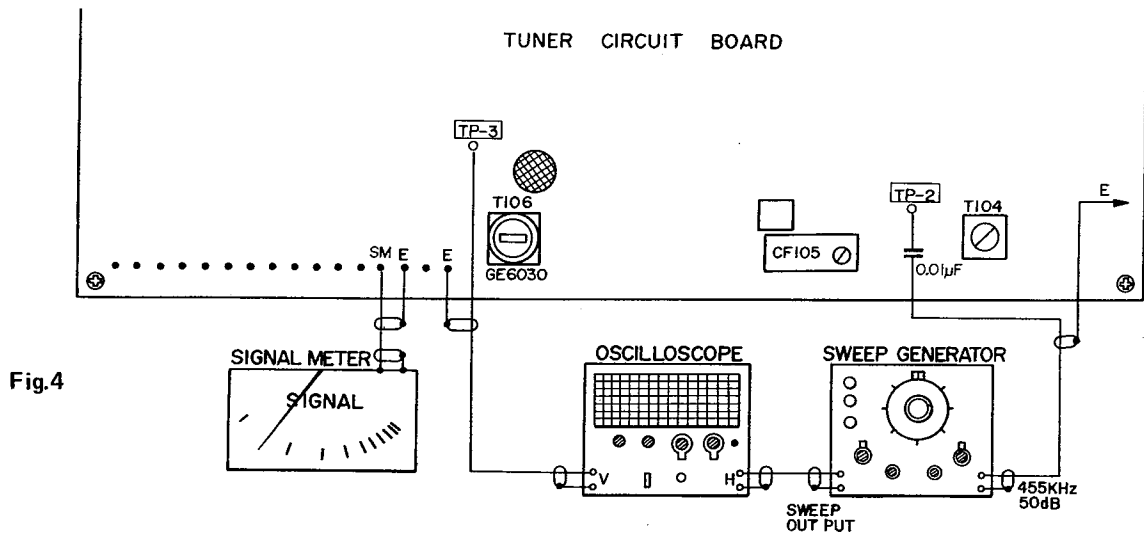

Fig.4

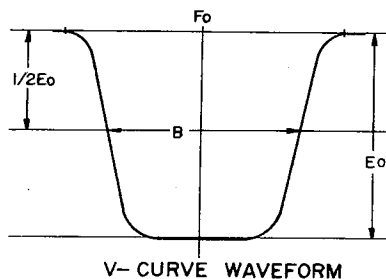

Fig.5

E_o	OUTPUT VOLTAGE	more than 500mV
f_o	INTERMEDIATE FREQUENCY	455kHz ± 10kHz NOTE: Intermediate Frequency in SOUTH AFRICA is 470kHz ± 10kHz
B	BANDWIDTH	more than 5kHz

FM-MPX ADJUSTMENT

STEP	ALIGNMENT ITEM	TERMINALS TO BE CONNECTED	INSTRUMENT REQUIRED	ADJUST	HOW TO ADJUST	RATING OR STANDARD	REMARKS
1	Pilot signal	FM antenna terminal 300Ω. Oscilloscope connection to TP1 (LA3311 No. 14 pin) Refer to Fig.7.	Same as 2. Antenna input 60dBμ. Stereo 100% separation.	T102 (GE 6056) Refer to Fig.6.	Set for minimum variation at maximum output power.	Should be approx. 2Vp-p by LA3311 No. 14 pin.	Tuning point of 2

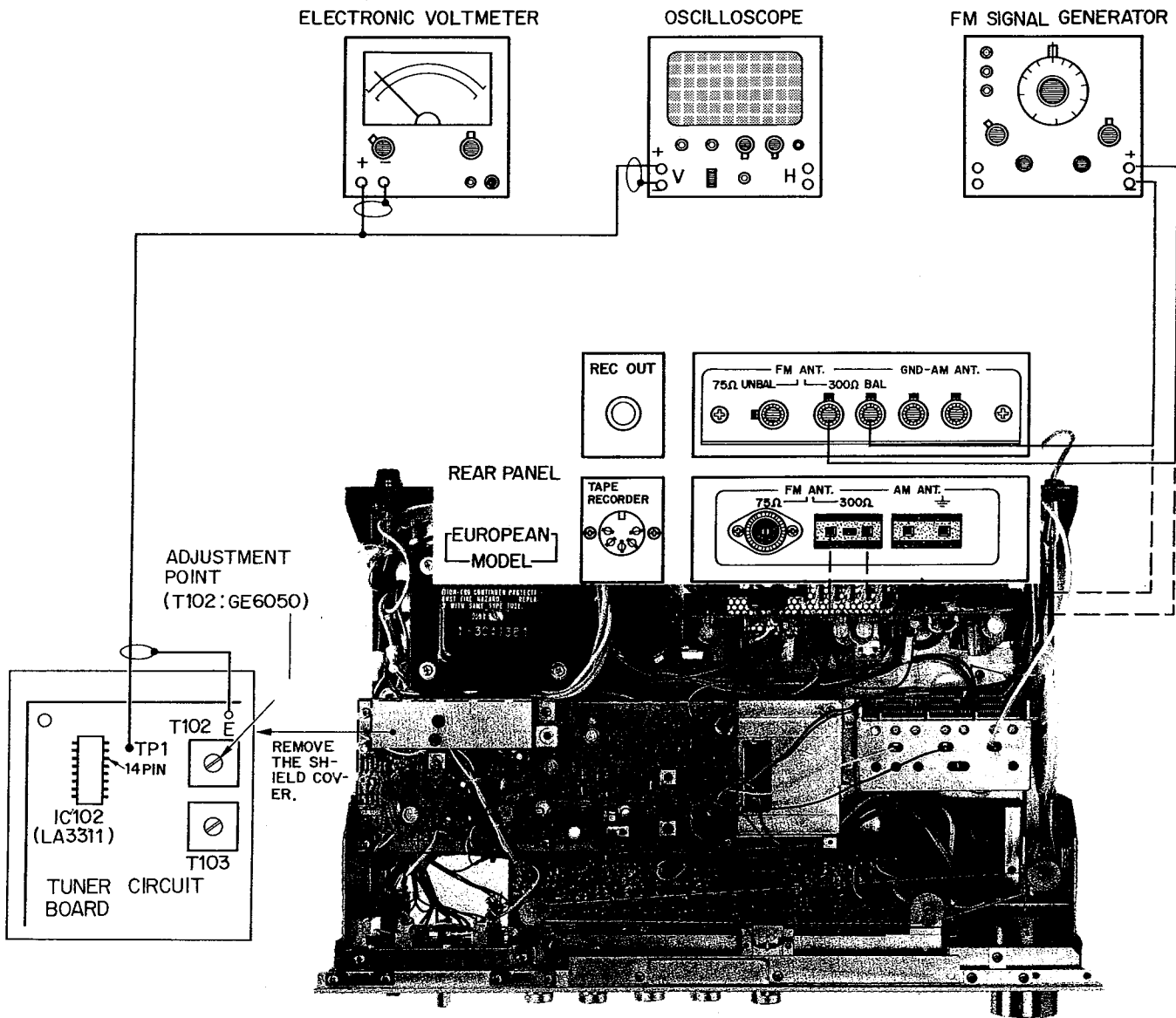

Fig.6

Fig.7

STEP	ALIGNMENT ITEM	TERMINALS TO BE CONNECTED	INSTRUMENT REQUIRED	ADJUST	HOW TO ADJUST	RATING OR STANDARD	REMARKS
2	Separation adjustment	FM antenna terminal	Same as 5.	VR102 (10kΩB)	Adjust VR102 for best L-R separation. Refer to Fig.8.	Variation for both channels at the same time should be more than 26dB, one channel should be 30dB. The difference between L and R should be within 3dB.	Tuning point of 2

• Measuring device connection is the same as shown in Fig. 9.

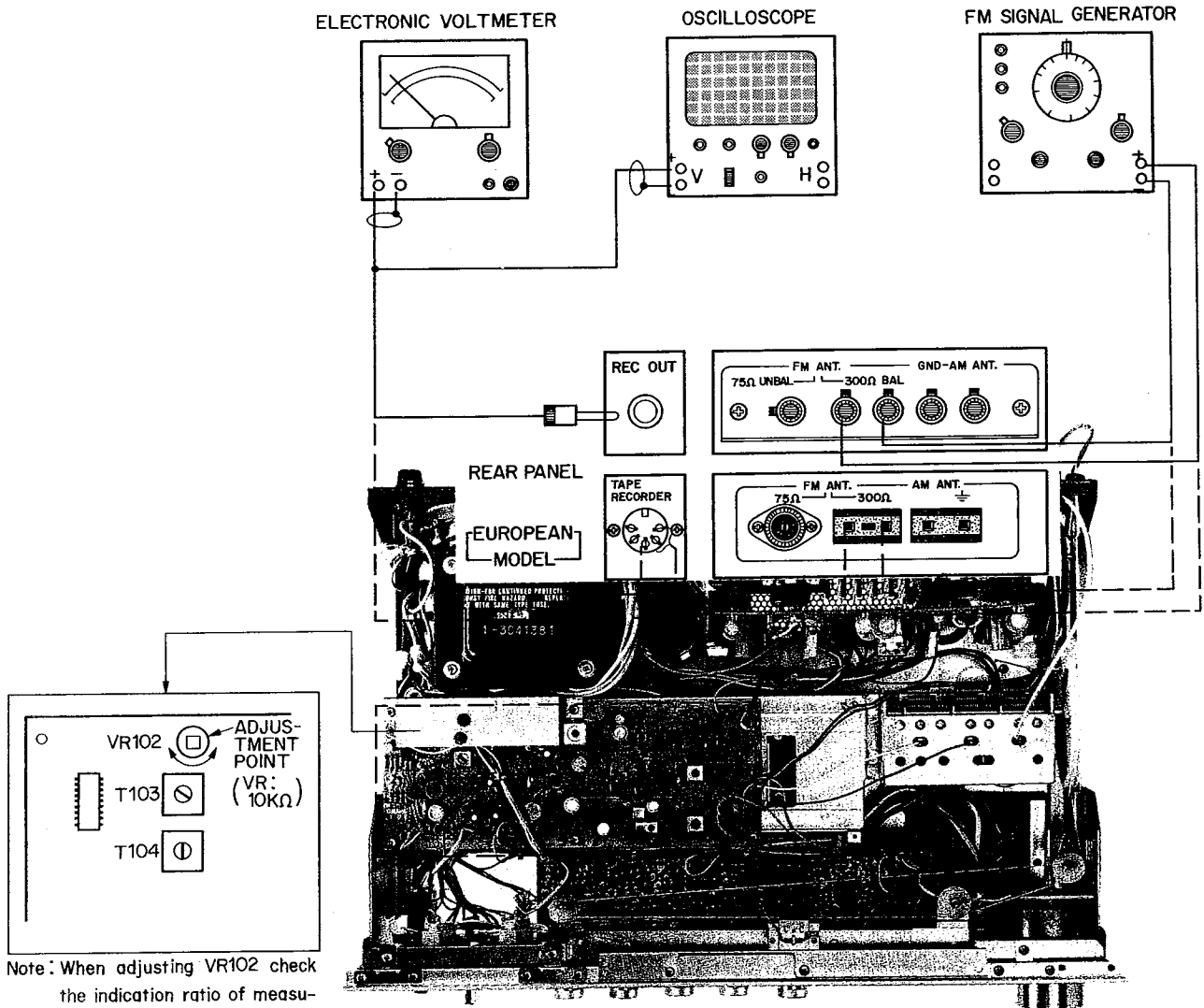

Fig.8

Fig.9

FM TUNER ADJUSTMENT

STEP	ALIGNMENT ITEM	TERMINALS TO BE CONNECTED	INSTRUMENT REQUIRED	ADJUST	HOW TO ADJUST	RATING OR STANDARD	REMARKS
1	Discrim balance			T101 discrim coil secondary side (top) See Fig.10.	Adjust for tuning meter position at 0 with Out of Tune noise. Refer to Fig.11.		Do not connect anything to the FM antenna terminal.

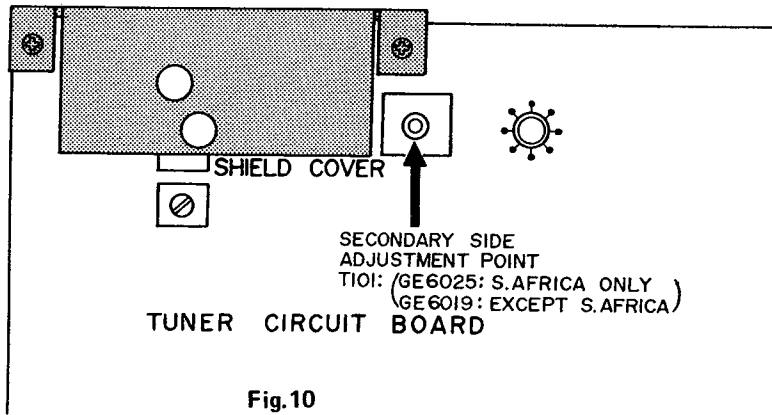

Fig.10

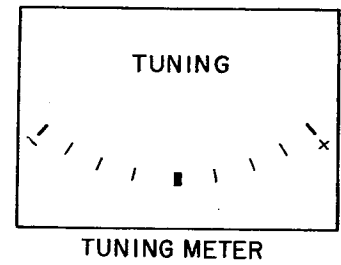

Fig.11

STEP	ALIGNMENT ITEM	TERMINALS TO BE CONNECTED	INSTRUMENT REQUIRED	ADJUST	HOW TO ADJUST	RATING OR STANDARD	REMARKS
2	Tuning point set	FM antenna terminal	FMSG 98MHz 60dBμ Mono 400Hz 100% Refer to Fig.12.	Tuning knob	Center the tuning meter at 0 by tuning in the same. Refer to Fig.13.		AFC OFF
3	Front-end IF tuning	FMSG 98MHz 30dBμ Mono 400Hz 100% Refer to Fig.12.	FMSG 98MHz Mono 400Hz 100% Refer to Fig.12.	Front-end IF core primary and secondary side.	Set for maximum signal meter deflection. Refer to Fig.14.		Should be set at tuning point 2.

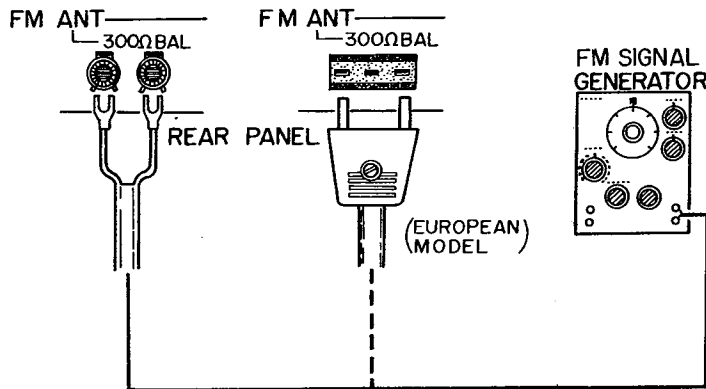

Fig.12

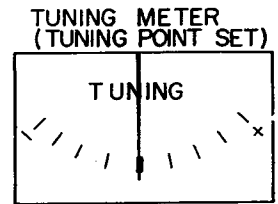

Fig.13

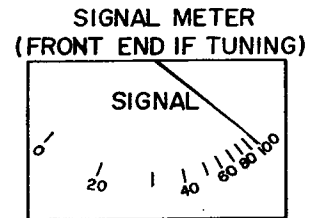

Fig.14

STEP	ALIGNMENT ITEM	TERMINALS TO BE CONNECTED	INSTRUMENT REQUIRED	ADJUST	HOW TO ADJUST	RATING OR STANDARD	REMARKS
4	Distortion adjustment (mono)	FM antenna terminal 300Ω Rec Out terminal	Same as 2 (antenna input: 60dBμ) Oscilloscope level gauge, distortion ratio meter: refer to Fig.15.	T101 discrim coil primary side (bottom) core. Refer to Fig.16.	Adjust right and left little by little until achieving lowest distortion. Less than -50dB	Less than -50dB	Tuning point of 2.

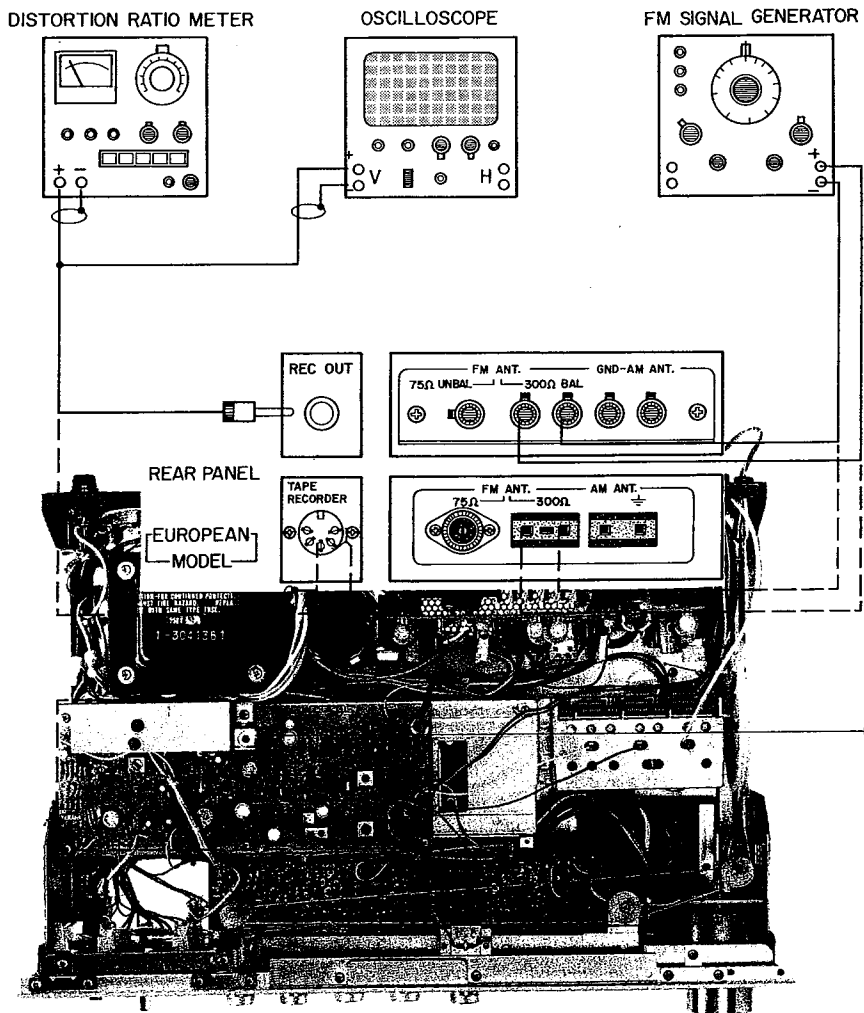

Fig.15

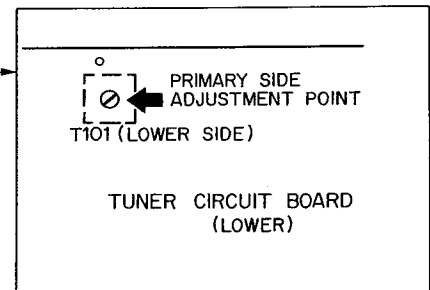

Fig.16

STEP	ALIGNMENT ITEM	TERMINALS TO BE CONNECTED	INSTRUMENT REQUIRED	ADJUST	HOW TO ADJUST	RATING OR STANDARD	REMARKS
5	Distortion ratio adjustment (stereo)	FM antenna terminal Rec Out terminal	Same as 2. Antenna input 60dB μ . Stereo 100%. Refer to Fig.18.	T103 (GE 6069) front end IF (top and bottom) core. Refer to Fig.17.	Adjust T103 for minimum distortion at maximum L-R signal. Adjust front end IF (top and bottom) core via L or R for minimum distortion. Refer to Fig.17.	Less than -38dB	Tuning point of 2

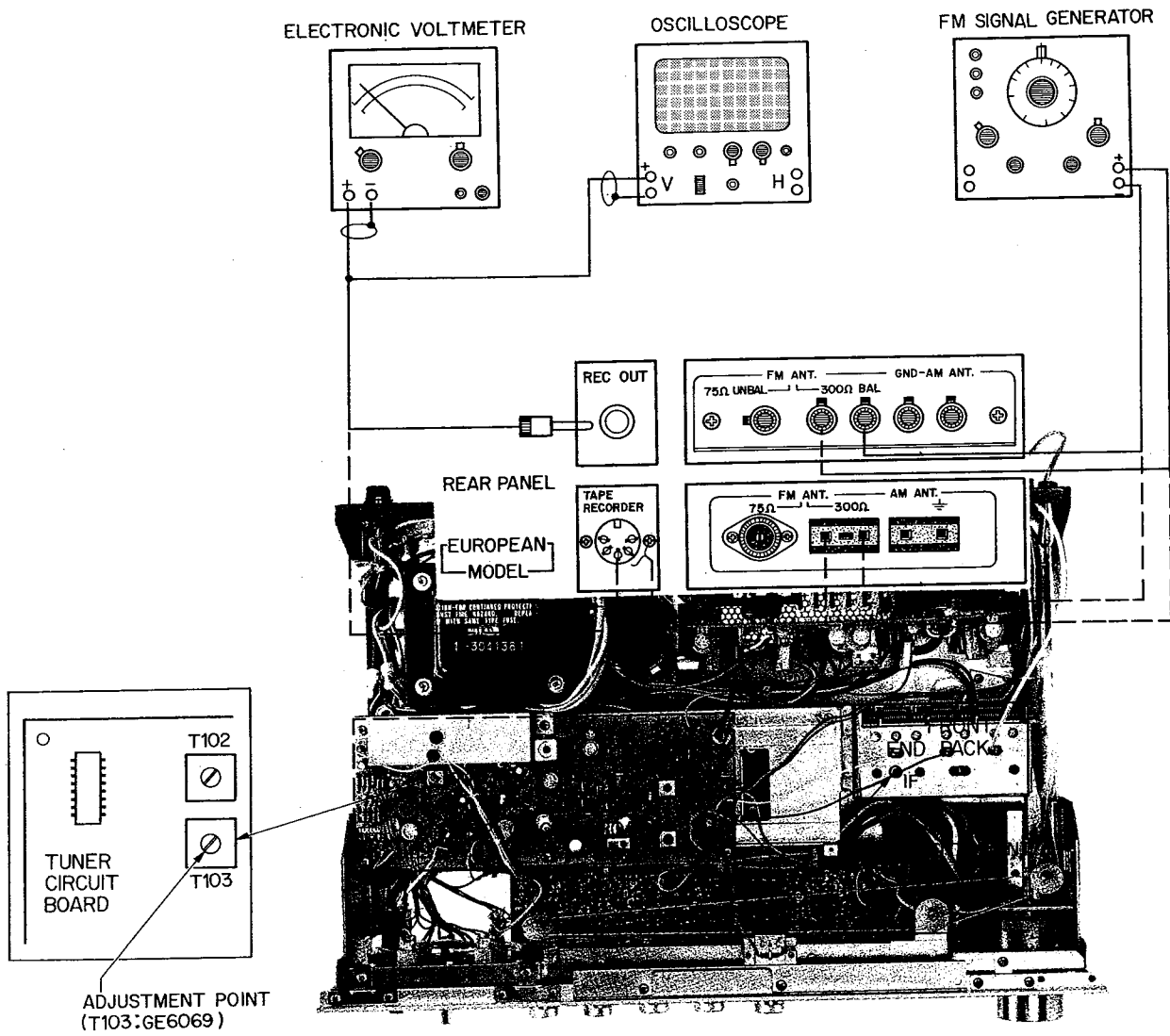

Fig.17

Fig.18

STEP	ALIGNMENT ITEM	TERMINALS TO BE CONNECTED	INSTRUMENT REQUIRED	ADJUST	HOW TO ADJUST	RATING OR STANDARD	REMARKS
6	Muting level adjustment	FM antenna terminal	Set VR101 all the way to the left. Refer to Fig.19.	VR101 (470B) Refer to Fig.20.	Turn to the right little by little until output power appears.	Level where output appears	Tuning point of 2

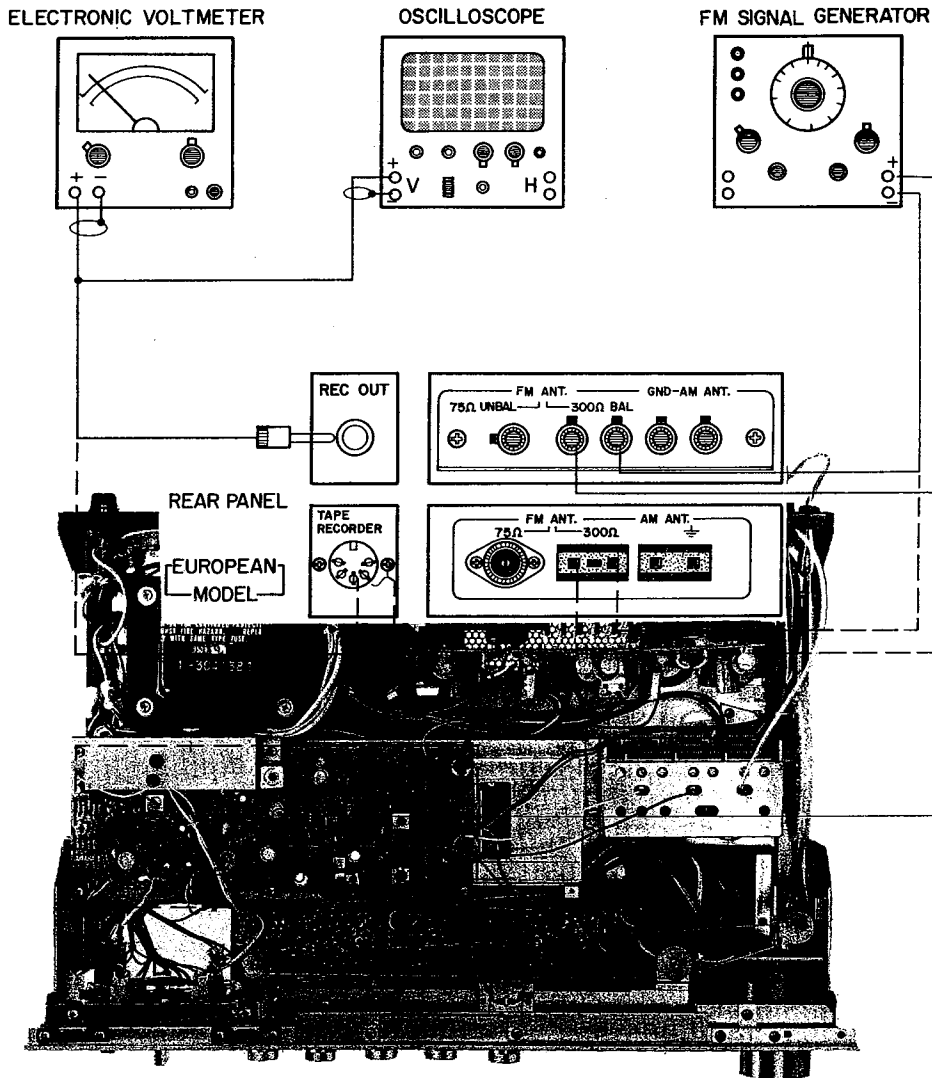
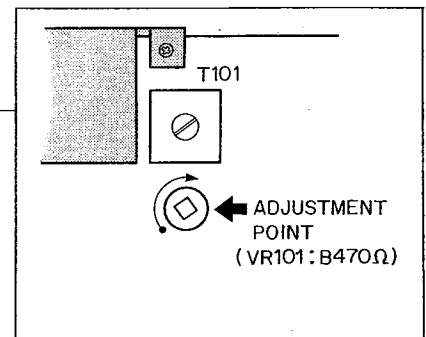

Fig.19



Note: When adjusting VR101 check the indication ratio of measuring device and turn gently.

Fig.20

FM TRACKING ADJUSTMENT

STEP	ALIGNMENT ITEM	TERMINALS TO BE CONNECTED	INSTRUMENT REQUIRED	ADJUST	HOW TO ADJUST	RATING OR STANDARD	REMARKS
1	Indicator adjustment I Indicator adjustment II	FM antenna terminal	Antenna input 60dB μ	Tuning knob Indicator	Turn the knob and set the tuning point at 3-2. Set to the middle of the "98" on the gauge board.		AFC-OFF
2	Bass tracking conformation	FM antenna terminal	FMSG 90MHz Antenna input 60dB μ	Tuning knob	Turn the knob and set the tuning point at 1.	Within ± 1.5 -mm from the middle of the	AFC-OFF Either 2 or 2' will be out of the standard slide
2'	Treble tracking conformation	FM antenna terminal AFC muting sheet CM-E	FMSG 106MHz Antenna input 60dB μ	Indicator	Check the displacement from the middle of the gauge board letter.	letter.	indicator. Set to standard frequency using the one out of standard.
3	Tracking adjustment I	FM antenna terminal	FMSG 90, 98, 106MHz Antenna input 60dB μ	Tuning knob Indicator	Reset the indicator so that the greatest deviation is within the standard range.		When both 2 and 2' are out of the standard range.
4	Tracking adjustment II	FM antenna terminal	FMSG 90, 98, 106MHz. Antenna input power 60dB μ 30dB μ 106MHz antenna input 60dB μ 30dB μ	Tuning knob Front end LOSC core Front end RF core antenna core Front end LOSC trimmer RF trimmer Antenna trimmer	Set the indicator at the letter Set the tuning point at 1 Set for maximum meter deflection Set the tuning point at 1 Set for maximum meter deflection		Even when adjusted by methods 2, 2' and 3, results are still not within the standard range.

AM TRACKING ADJUSTMENT

- Be sure to carry out this adjustment after FM adjustment

STEP	ALIGNMENT ITEM	TERMINALS TO BE CONNECTED	INSTRUMENT REQUIRED	ADJUST	HOW TO ADJUST	RATING OR STANDARD	REMARKS
1	OSC coil	Bar antenna Rec Out terminal	AMSG (600kHz) Oscilloscope Electronic voltmeter	Tuning knob AM tuner sheet I105 coil Refer to Fig.21.	Set indicator at 600kHz. Set it to tune at 600kHz.		
2	Bass sensitivity adjustment	Bar antenna Rec Out terminal	AMSG (600kHz) Oscilloscope Electronic voltmeter	Bar antenna T104 coil Refer to Fig.21.	Set for maximum sensitivity (according to the meter) at a tuning point of 600kHz.		
3	OSC trimmer adjustment	Bar antenna Rec Out terminal	AMSG (1350-kHz) Oscilloscope Electronic voltmeter	Tuning knob Variable capacitor VC3 trimmer condenser Refer to Fig.22.	Set the indicator 1350kHz. Adjust at 1350kHz to tune.		Liner gauge
4	Treble sensitivity adjustment	Bar antenna Rec Out terminal	AMSG (1350-kHz) Oscilloscope Electronic voltmeter	Variable capacitor VC1, VC2 Refer to Fig.22.	Set for maximum sensitivity (by the meter) at 1350kHz tuning point.		
5	Sensitivity variation adjustment	Bar antenna Rec Out terminal	AMSG (600-kHz ~ 1350kHz) Oscilloscope Electronic voltmeter	Repeat steps 1-4.	Set to both 600kHz and 1350kHz.		
6	Mid-range conformation	Bar antenna Rec Out terminal	AMSG (90kHz) Oscilloscope Electronic voltmeter	Tuning knob	Tune at maximum sensitivity (on the meter)	Within 1.5mm deviation from the 950kHz letter	Equation gauge 5.51

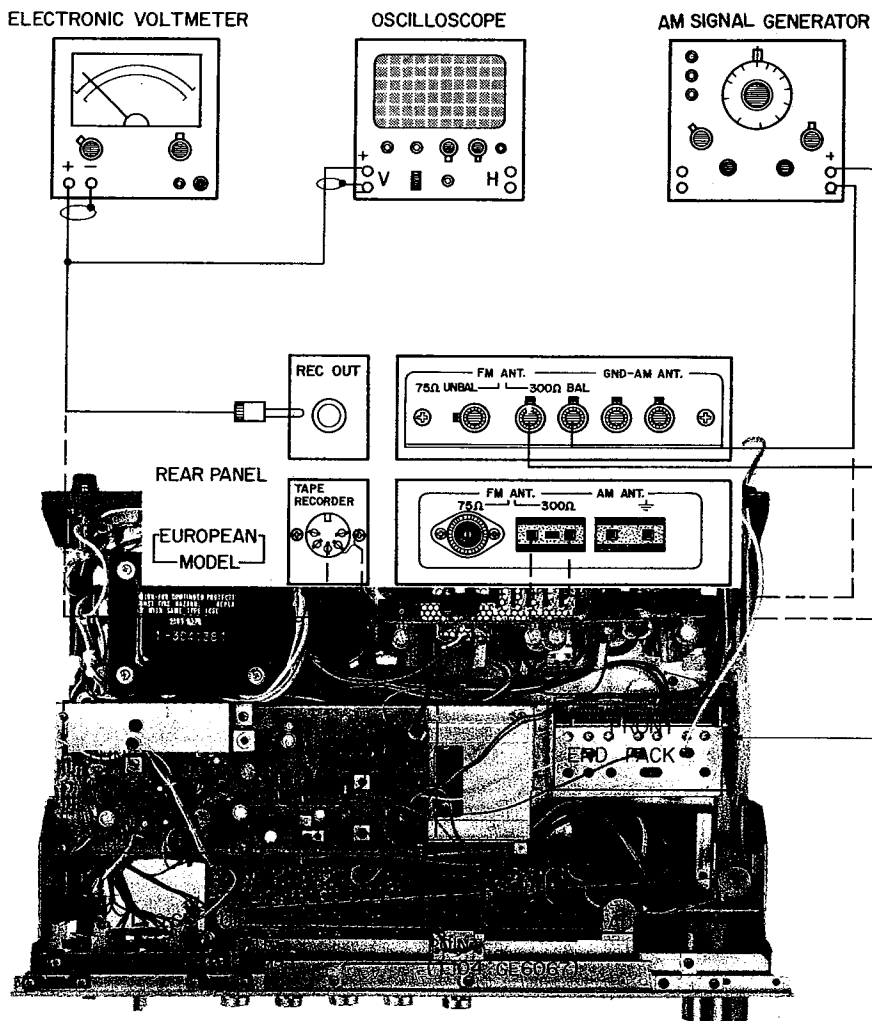

Fig.21

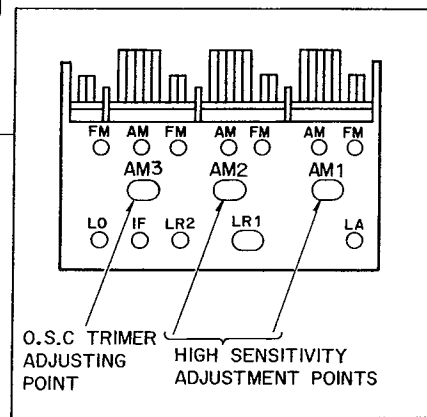

Fig.22

MAIN AMP CIRCUIT

STEP	ALIGNMENT ITEM	TERMINALS TO BE CONNECTED	INSTRUMENT REQUIRED	ADJUST	HOW TO ADJUST	RATING OR STANDARD	REMARKS
1	Mid-point Voltage	TP3-TP5 TP4-TP6	Electronic Voltmeter	VR701 VR702	Set at standard ratio	$0 \pm 0.01V$	Refer to Fig.24.
2	Idling current	TP1-TP3 TP2-TP4	Electronic Voltmeter	VR703 VR704	Set at standard ratio	$0.023 \pm 0.005V$	Refer to Fig.24.
3	Make sure by repeating steps 1 and 2 several times.						

Note: TP5 and TP6 ground terminals can be grounded to the main sheet input ground terminal during midpoint voltage adjustment.

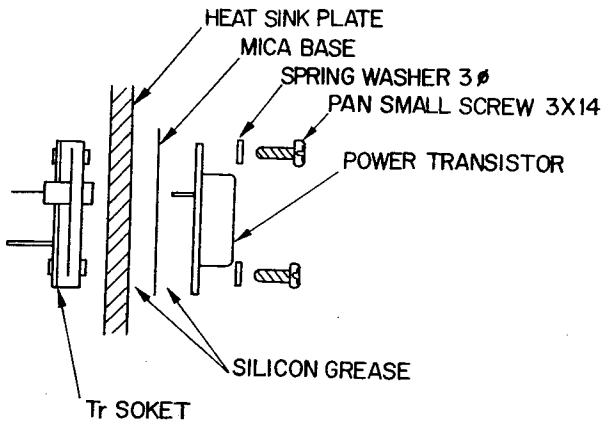

Fig.23

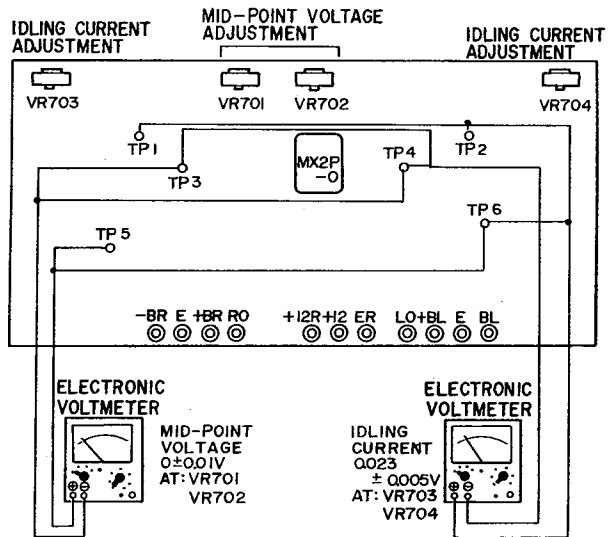

Fig.24

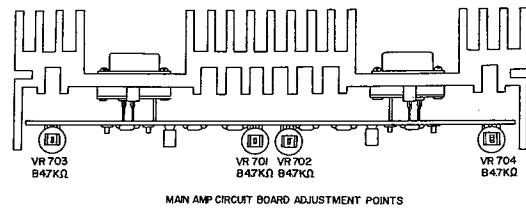
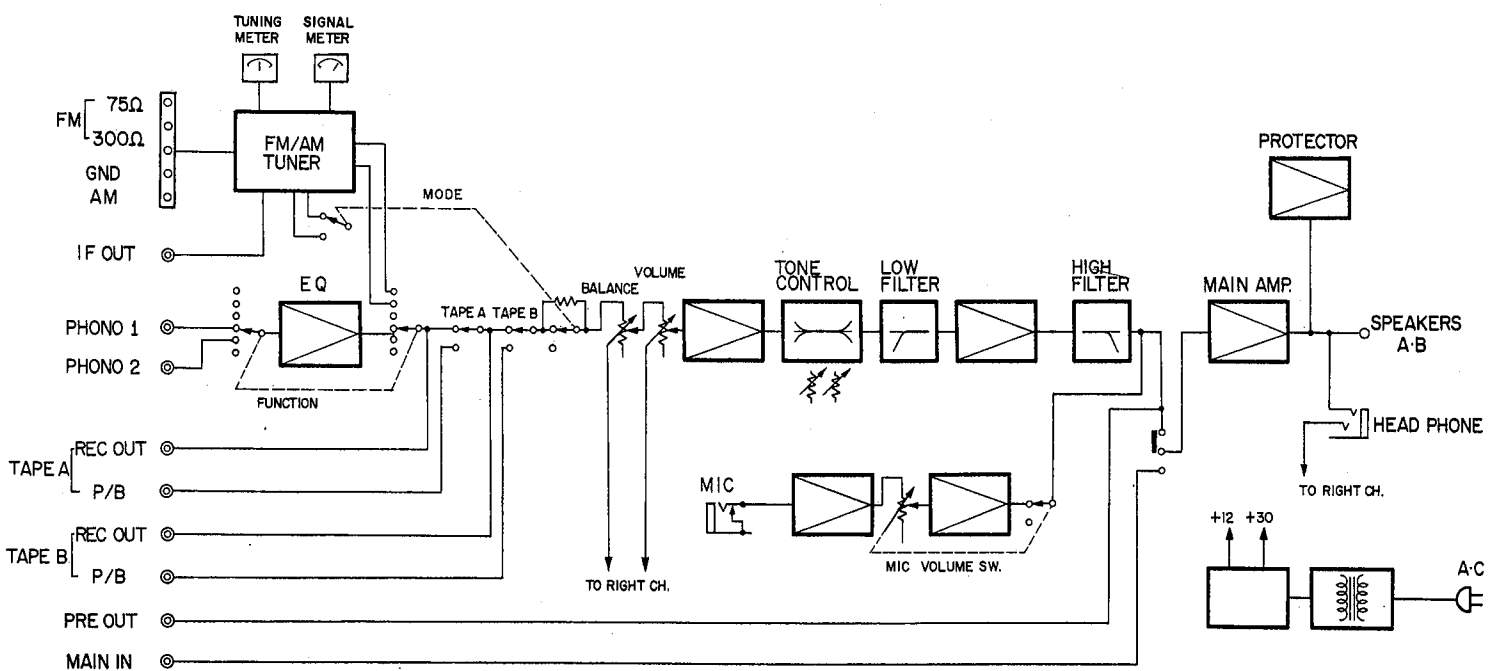
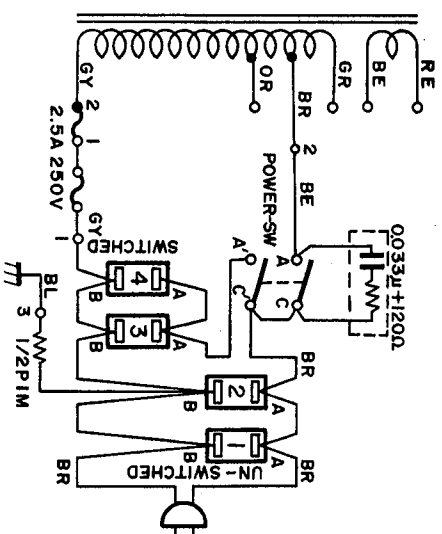

Fig.25

BLOCK DIAGRAM



**PARTIAL CHANGES MADE ACCORDING TO DESTINATION
POWER CIRCUIT : PRIMARY SIDE
U.S. & CANADIAN MODELS**



EUROPEAN MODEL

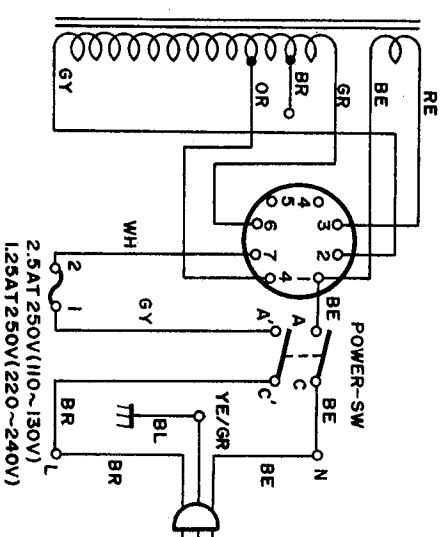

SOUTH AFRICAN MODEL

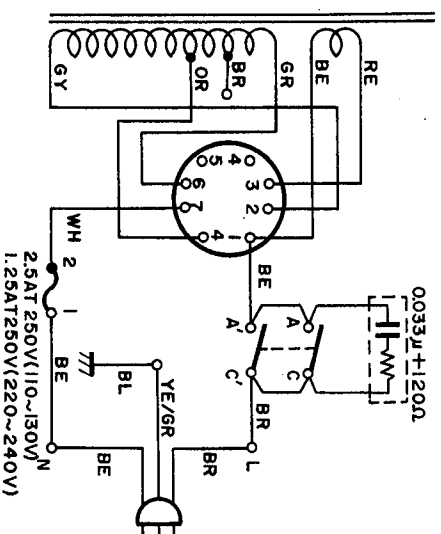

AUSTRALIAN MODEL

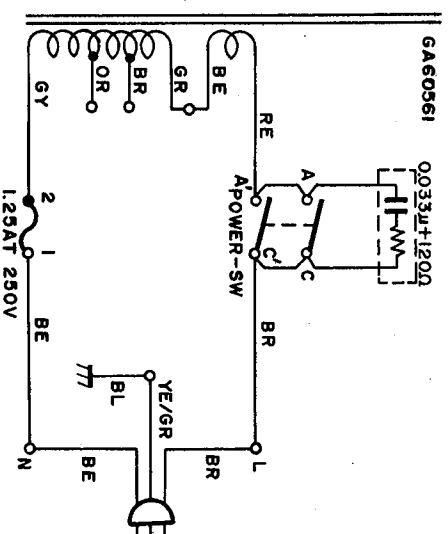

DE-EMPHASIS TIME CONSTANT (C, R) VALUE

DESTINATION	T 101	C 151	C 152
S. AFRICA	GE 6025	0.0075µF	0.0075µF
U.S. CANADA	GE 6019	0.011µF	0.011µF
GENERAL EUROPE AUSTRALIA	GE 6019	0.0075µF	0.0075µF

VOLTAGE TABLE of T-109, 112, 113, 114, 115, 801, 803.

	E	B	C		E	B	C	
TR 109	0	0.02	3.7	AT FM MUTING				
TR 112	0	0.65	0	AT FM MUTING				
TR 801	44	27	41	COLLECTOR VOLT.				
TR 803	44	27	41	COLLECTOR VOLT.				
TR 113	E	B	C		E	B	C	
	0	0.54	0	0.024	0	0.024	10.5	When tuning knob is released.
	0	0.65	0	0.058	0.006	0	0.01	10.5 When tuning knob is touched.

OVERALL SCHEMATIC DIAGRAM

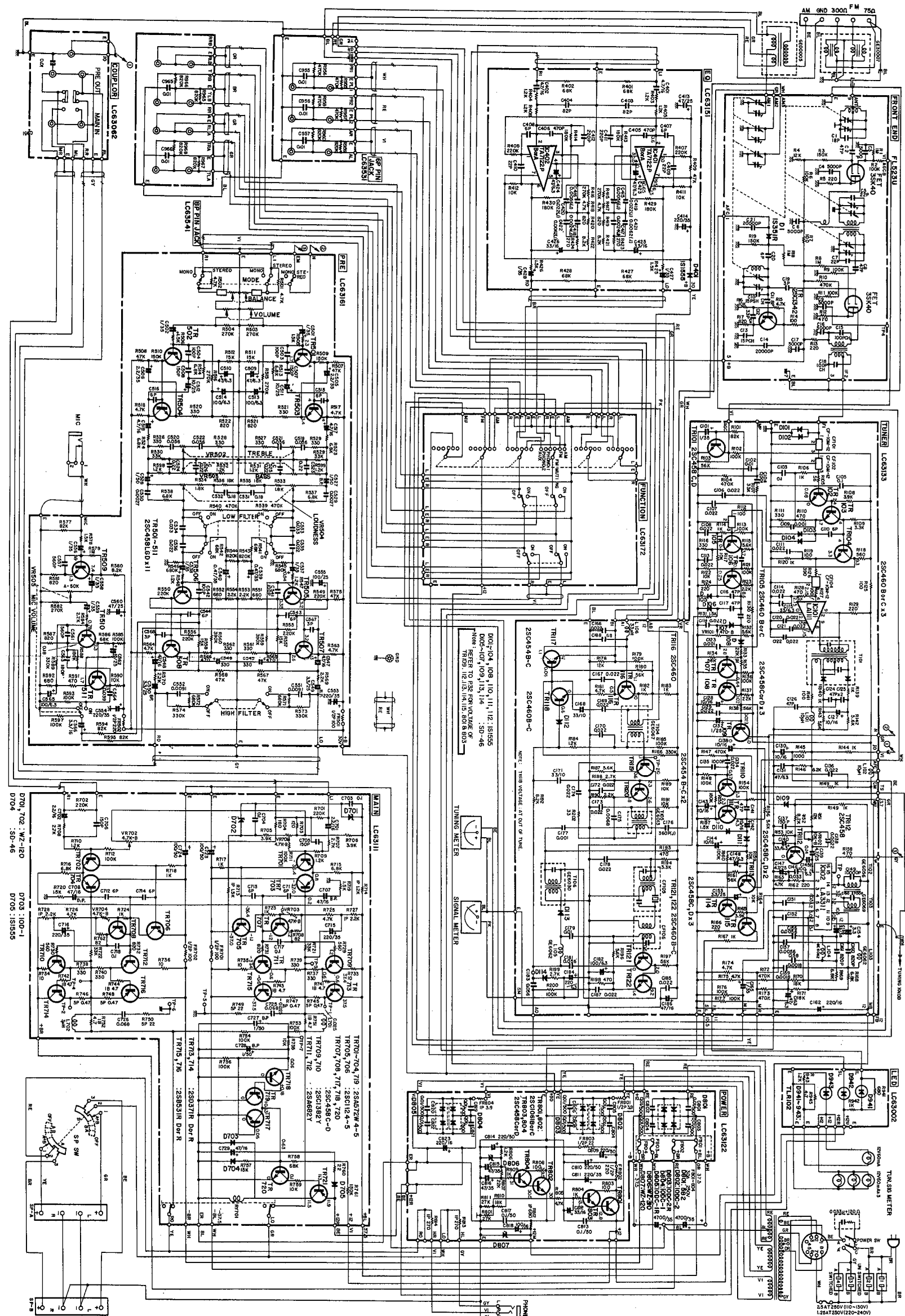

WIRE COLOR ABBREVIATIONS

- BL▶Black
- BR▶Brown
- RE▶Red
- OR▶Orange
- YE▶Yellow
- GR▶Green
- BE▶Blue
- VI▶Violet
- WH▶White
- GG▶Light Green
- SB▶Light Blue
- PK▶Pink

PRINTED CIRCUIT BOARD & SPECIAL REPLACEMENT PARTS LISTS

TUNER CIRCUIT BOARD NA06431 U.S., Canadian Models
 NA06432 General, Australian, European Models
 NA06438 South African Model

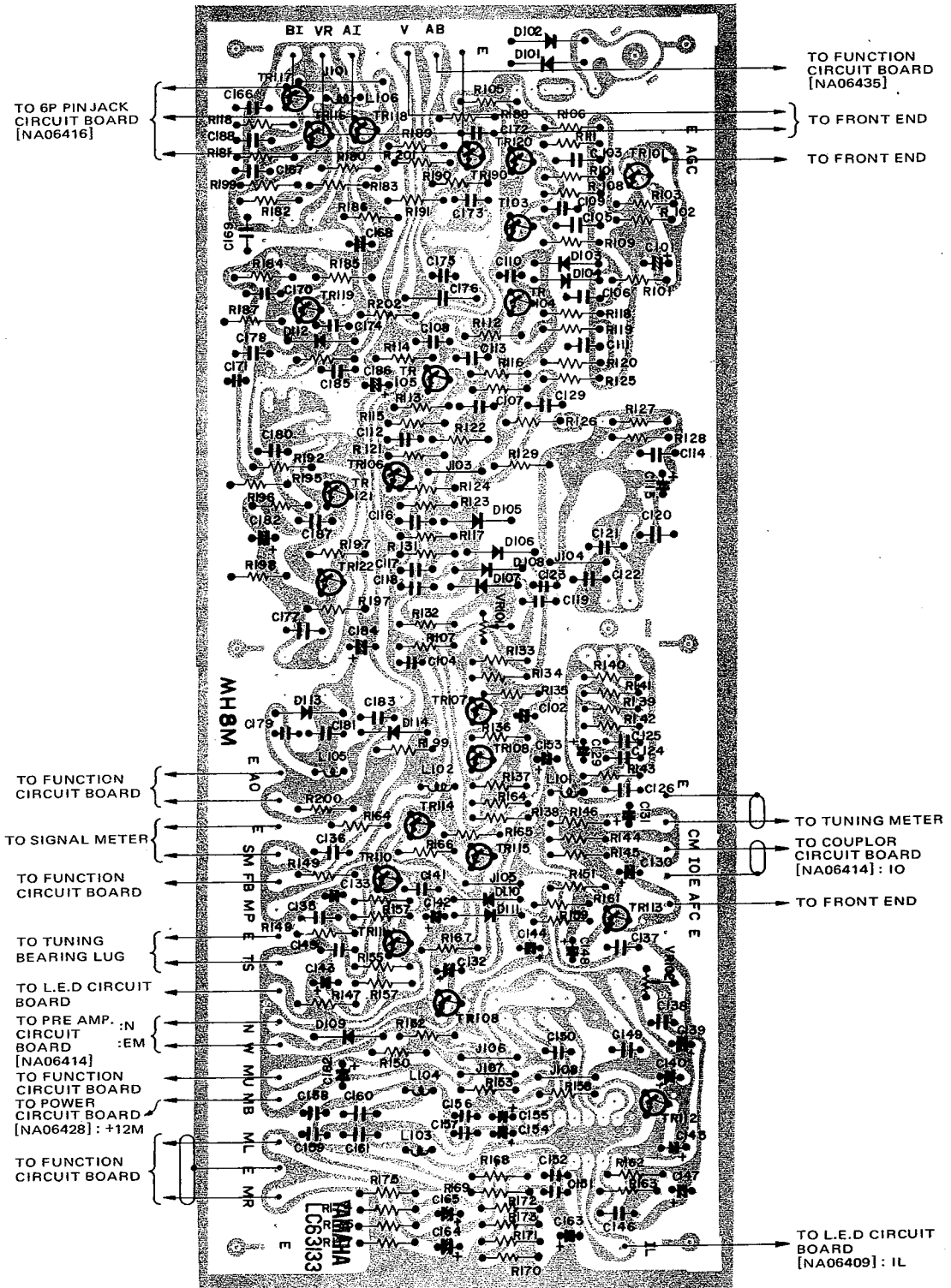

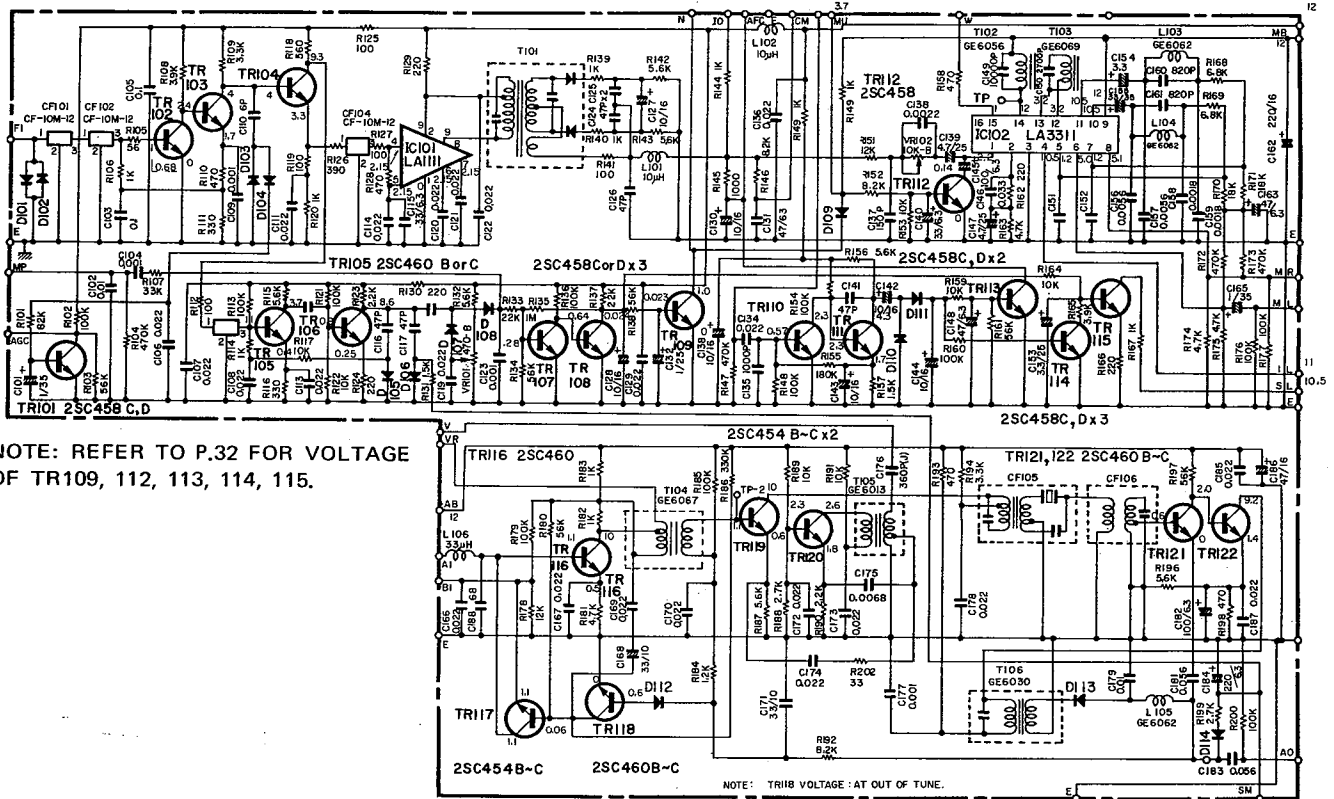

NOTE: REFER TO P.32 FOR VOLTAGE OF TR109, 112, 113, 114, 115.

NOTE: TR118 VOLTAGE: AT OUT OF TUNE.

Ref. No.	Description	Ref. No.	Description
C 101	Solid Tantalum Capacitor	D 108	Diode
C 149	Poly-Styrene Capacitor	D 109	Diode
C 150	Poly-Styrene Capacitor	D 110	Diode
C 154	Solid Tantalum Capacitor	D 111	Diode
C 155	Solid Tantalum Capacitor	D 112	Diode
C 164	Solid Tantalum Capacitor	D 113	Diode
C 165	Solid Tantalum Capacitor	D 114	Diode
C 168	Solid Tantalum Capacitor	IC101	Integrated Circuit
C 171	Solid Tantalum Capacitor	IC102	Integrated Circuit
C 176	Poly-Styrene Capacitor	VR101	Solid Variable Resistor
TR101	Transistor	VR102	Solid Variable Resistor
TR102	Transistor	T 101	FM IFT
TR103	Transistor	T 101	FM IFT
TR104	Transistor	T 102	MPX Coil
TR105	Transistor	T 103	MPX Coil
TR106	Transistor	T 104	AM RF Coil
TR107	Transistor	T 105	AM OSC Coil
TR108	Transistor	T 106	AM IFT
TR109	Transistor	L 101	RF Inductor
TR110	Transistor	L 102	RF Inductor
TR111	Transistor	L 103	MPX Coil
TR112	Transistor	L 104	MPX Coil
TR113	Transistor	L 105	MPX Coil
TR114	Transistor	L 106	RF Inductor
TR115	Transistor	CF101	Ceramic Filter Set
TR116	Transistor	CF102	Ceramic Filter Set
TR117	Transistor	CF103	Ceramic Filter Set
TR118	Transistor	CF104	Ceramic Filter Set
TR119	Transistor	CF105	AM Ceramic Filter
TR120	Transistor	CF105	AM Ceramic Filter
TR121	Transistor	CF106	AM Filter Coil
TR122	Transistor	CF106	AM Filter Coil
D 101	Diode		
D 102	Diode		
D 103	Diode		
D 104	Diode		
D 105	Diode		
D 106	Diode		
D 107	Diode		

EQ AMP CIRCUIT BOARD NA06433

TO FUNCTION
CIRCUIT BOARD: 14 ~ 16

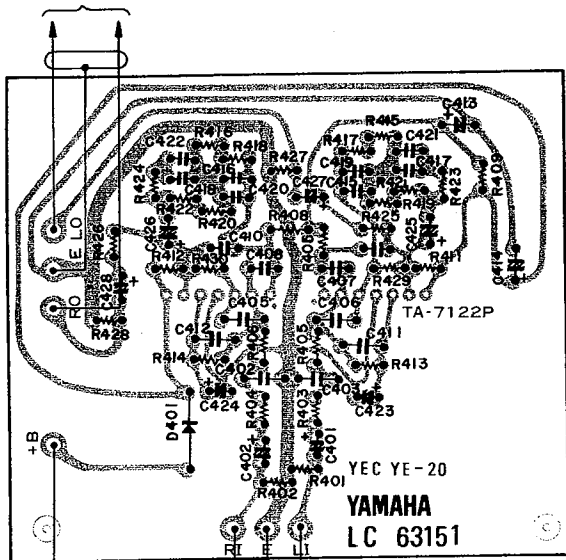

TO POWER
CIRCUIT BOARD
[NA06428] :+30

TO FUNCTION
CIRCUIT BOARD
[NA06435]:7 ~ 9

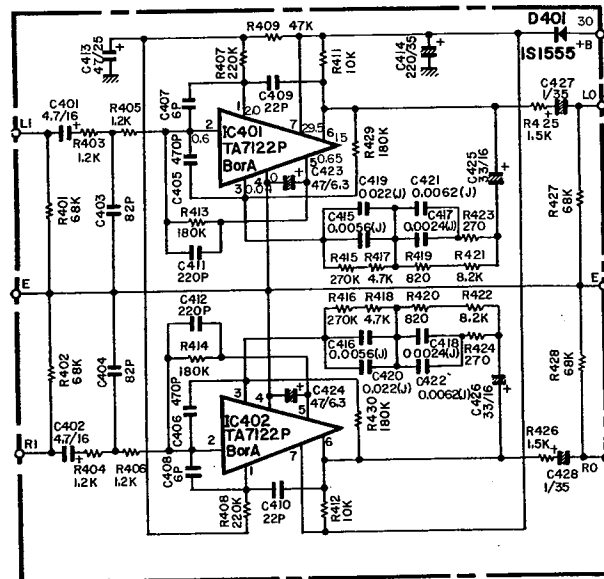

Ref. No.	Description		
C 401	Solid Tantalum Capacitor	4.7 μ F	16WV
C 402	Solid Tantalum Capacitor	4.7 μ F	16WV
C 427	Solid Tantalum Capacitor	1 μ F	35WV
C 428	Solid Tantalum Capacitor	1 μ F	35WV
D 401	Diode	1S1555	
IC401	Integrated Circuit	TA-7122P	B or C
IC402	Integrated Circuit	TA-7122P	B or C

8P PIN JACK CIRCUIT BOARD NA06417

TO FUNCTION CIRCUIT BOARD
[NA06435]

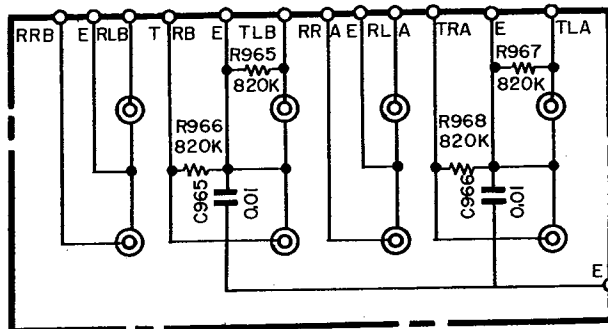
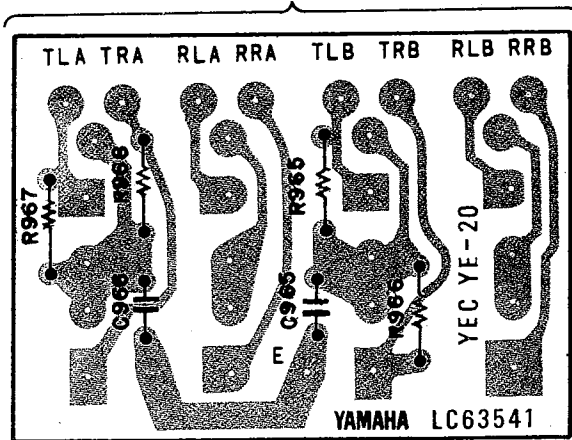

PRE AMP CIRCUIT BOARD NA06434

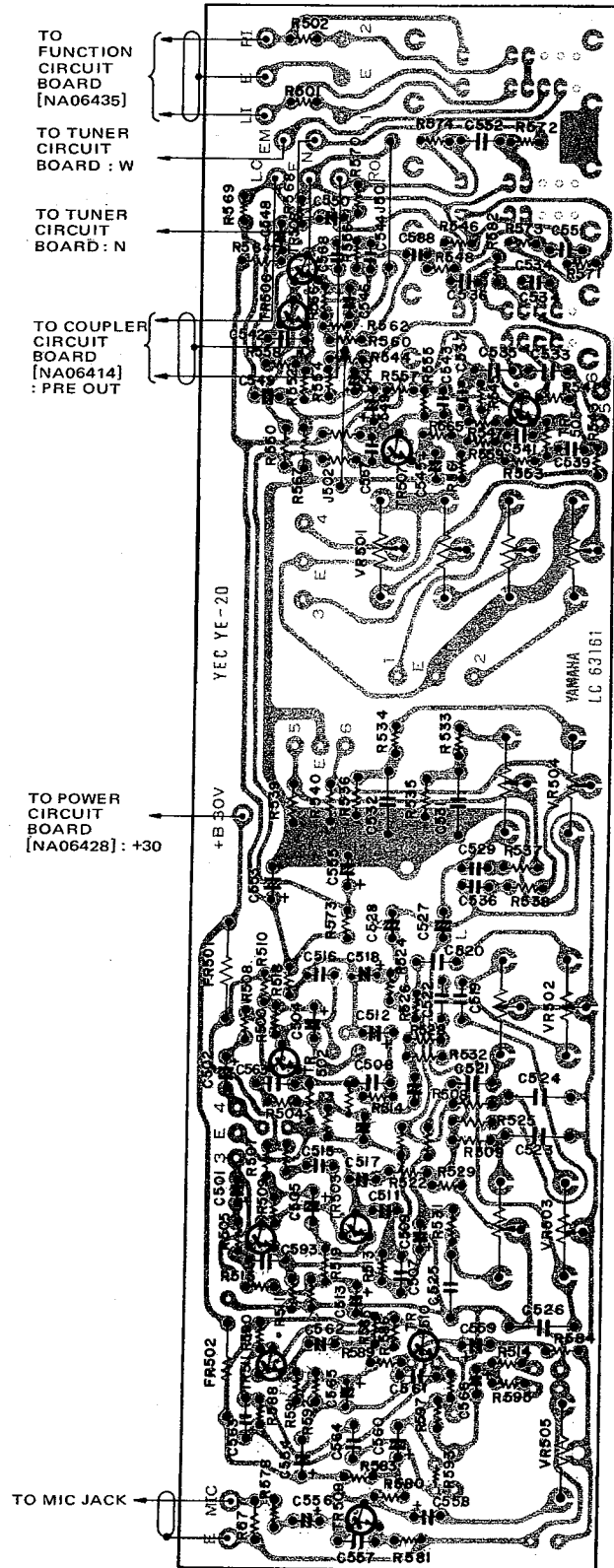

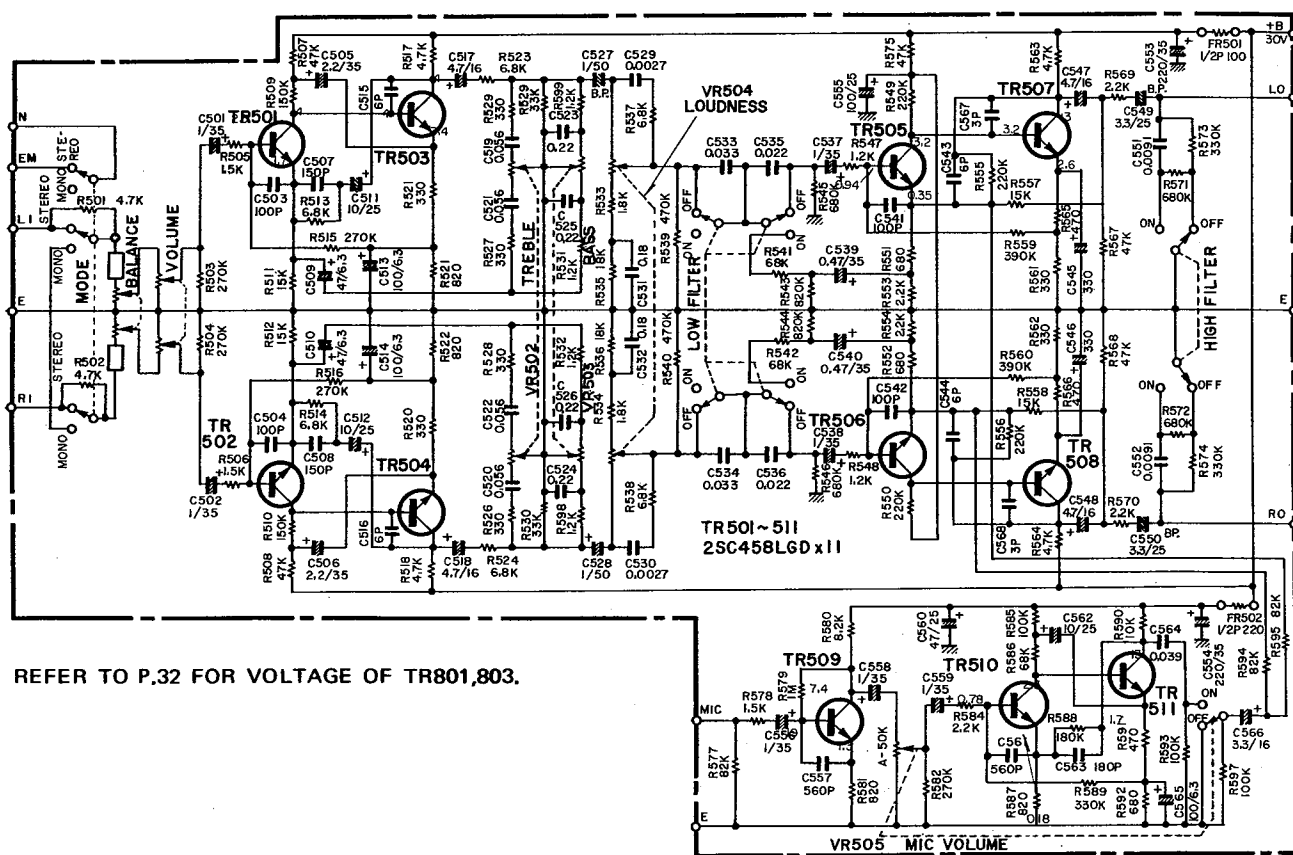

REFER TO P.32 FOR VOLTAGE OF TR801,803.

Ref. No.	Description		
FR501	Fuse Resistor	100Ω	1/2W
FR502	Fuse Resistor	220Ω	1/2W
C 501	Solid Tantalum Capacitor	1μF	35WV
C 502	Solid Tantalum Capacitor	1μF	35WV
C 505	Solid Tantalum Capacitor	2.2μF	35WV
C 506	Solid Tantalum Capacitor	2.2μF	35WV
C 517	Solid Tantalum Capacitor	4.7μF	16WV
C 518	Solid Tantalum Capacitor	4.7μF	16WV
C 527	Bi-Polar Electrolytic Capacitor	1μF	50WV
C 528	Bi-Polar Electrolytic Capacitor	1μF	50WV
C 537	Solid Tantalum Capacitor	1μF	35WV
C 538	Solid Tantalum Capacitor	1μF	35WV
C 539	Solid Tantalum Capacitor	0.47μF	35WV
C 540	Solid Tantalum Capacitor	0.47μF	35WV
C 547	Solid Tantalum Capacitor	4.7μF	16WV
C 548	Solid Tantalum Capacitor	4.7μF	16WV
C 549	Bi-Polar Electrolytic Capacitor	3.3μF	25WV
C 550	Bi-Polar Electrolytic Capacitor	3.3μF	25WV
C 556	Solid Tantalum Capacitor	1μF	35WV

Ref. No.	Description		
C 558	Solid Tantalum Capacitor	1μF	35WV
C 559	Solid Tantalum Capacitor	1μF	35WV
C 566	Solid Tantalum Capacitor	3.3μF	16WV
TR501	Transistor	2SC458	LGD or LGC
TR502	Transistor	2SC458	LGD or LGC
TR503	Transistor	2SC458	LGD or LGC
TR504	Transistor	2SC458	LGD or LGC
TR505	Transistor	2SC458	LGD or LGC
TR506	Transistor	2SC458	LGD or LGC
TR507	Transistor	2SC458	LGD or LGC
TR508	Transistor	2SC458	LGD or LGC
TR509	Transistor	2SC458	LGD or LGC
TR510	Transistor	2SC458	LGD or LGC
TR511	Transistor	2SC458	LGD or LGC
VR501	Variable Resistor	HB-250kΩ	A-100kΩ
VR502	Variable Resistor	XZ-10kΩ	x 2
VR503	Variable Resistor	XZ-25kΩ	x 2
VR504	Variable Resistor	B-20kΩ	x 2 with Click
VR505	Variable Resistor	A-50kΩ	with Switch

MAIN AMP CIRCUIT BOARD NA06427

TO COUPLER CIRCUIT BOARD [NA06414]: L, R

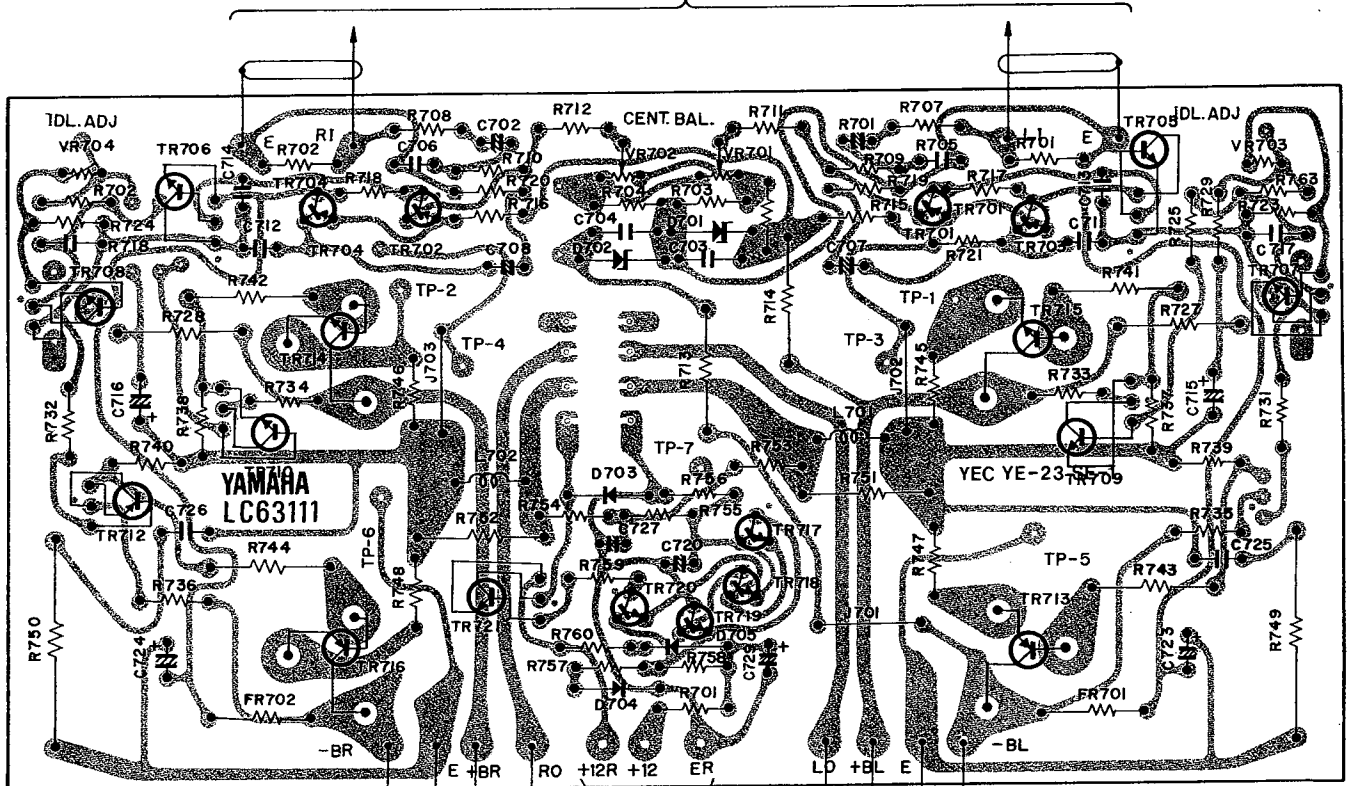

TO ELECTROLYTIC CAPACITOR [4700µF/50WV]

TO POWER CIRCUIT BOARD [NA06428]: +12, +12R

TO ELECTROLYTIC CAPACITOR [4700µF/50WV]

TO POWER CIRCUIT BOARD : R0, L0, +BL, -BL, +BR, -BR

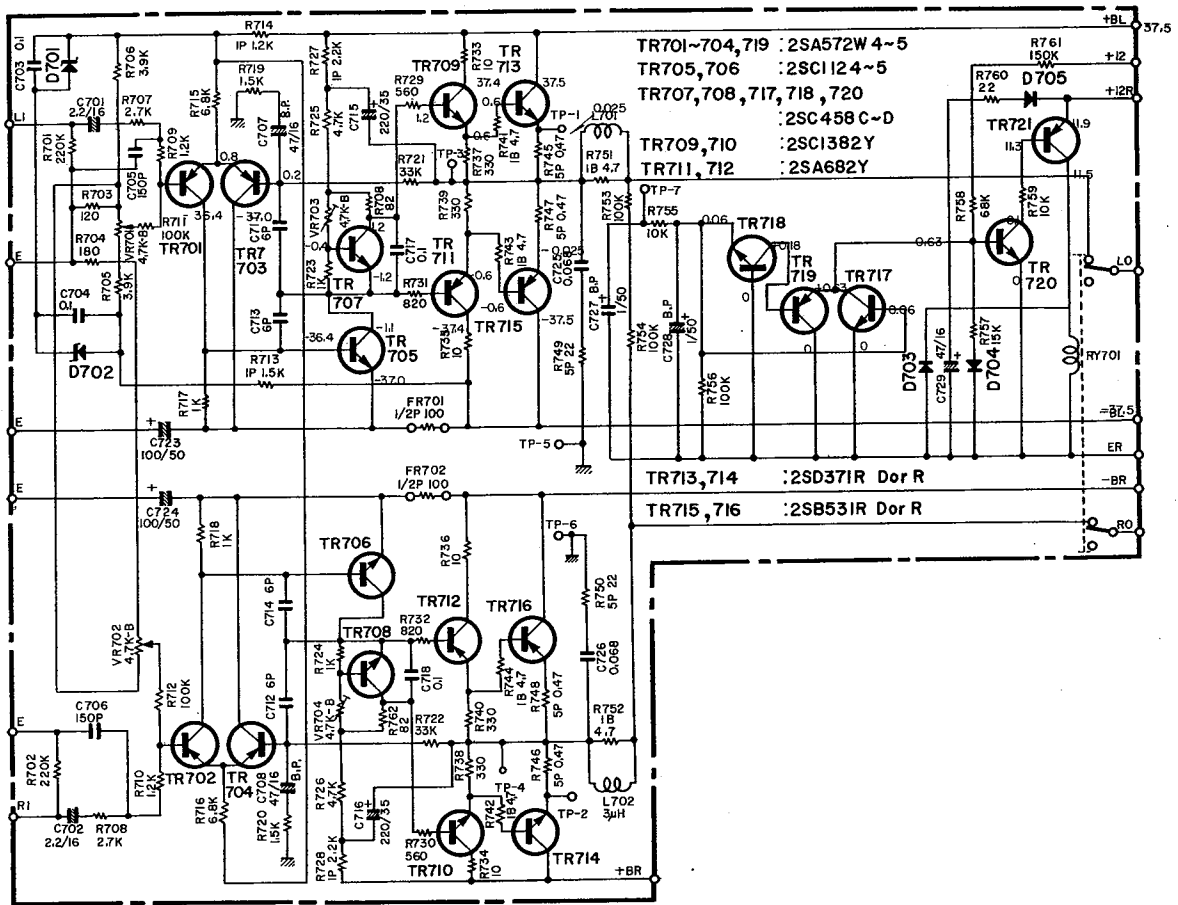

Ref. No.	Description			Ref. No.	Description		
R 713	Metal-Oxide Film Resistor	1.5k Ω	1W	TR706	Transistor	2SC1124	2
R 714	Metal-Oxide Film Resistor	1.2k Ω	1W	TR707	Transistor	2SC458	C~D
R 727	Metal-Oxide Film Resistor	2.2k Ω	1W	TR708	Transistor	2SC458	C~D
R 728	Metal-Oxide Film Resistor	2.2k Ω	1W	TR709	Transistor	2SC1382	Y~O
R 741	Incombustible Resistor	4.7 Ω	1W	TR710	Transistor	2SC1382	Y~O
R 742	Incombustible Resistor	4.7 Ω	1W	TR711	Transistor	2SA682	O~Y
R 743	Incombustible Resistor	4.7 Ω	1W	TR712	Transistor	2SA682	O~Y
R 744	Incombustible Resistor	4.7 Ω	1W	TR713	Transistor	2SD371	O~R
R 745	Metal Plate Resistoe	0.47 Ω	5W	TR714	Transistor	2SD371	O~R
R 746	Metal Plate Resistor	0.47 Ω	5W	TR715	Transistor	2SB531	O~R
R 747	Metal Plate Resistor	0.47 Ω	5W	TR716	Transistor	2SB531	O~R
R 748	Metal Plate Resistor	0.47 Ω	5W	TR717	Transistor	2SC458	C~D
R 749	Cement Resistor	22 Ω	5W	TR718	Transistor	2SC458	C~D
R 750	Cement Resistor	22 Ω	5W	TR719	Transistor	2SA572	W4~5
R 751	Incombustible Resistor	4.7 Ω	1W	TR720	Transistor	2SC458	C~D
R 752	Incombustible Resistor	4.7 Ω	1W	TR721	Transistor	2SA682	O~Y
FR701	Fuse Resistor	100 Ω	1/2W	D 701	Zener Diode	WZ-120	
FR702	Fuse Resistor	100 Ω	1/2W	D 702	Zener Diode	WZ-120	
C 701	Bi-Polar Electrolytic Capacitor	2.2 μ F	16WV	D 703	Diode	10D-1	
C 702	Bi-Polar Electrolytic Capacitor	2.2 μ F	16WV	D 704	Diode	SD-46	
C 707	Bi-Polar Electrolytic Capacitor	47 μ F	16WV	D 705	Diode	1S1555	
C 708	Bi-Polar Electrolytic Capacitor	47 μ F	16WV	VR701	Solid Variable Resistor	B 4.7k Ω	SR-29R
C 727	Bi-Polar Electrolytic Capacitor	1 μ F	50WV	VR702	Solid Variable Resistor	B 4.7k Ω	SR-29R
C 728	Bi-Polar Electrolytic Capacitor	100 μ F	6.3WV	VR703	Solid Variable Resistor	B 4.7k Ω	SR-29R
TR701	Transistor	2SA572	W4~5	VR704	Solid Variable Resistor	B 4.7k Ω	SR-29R
TR702	Transistor	2SA572	W4~5	L 701	Coil	3.0 μ H	
TR703	Transistor	2SA572	W4~5	L 702	Coil	3.0 μ H	
TR704	Transistor	2SA572	W4~5	RY701	Relay	MX2P-O	12V
TR705	Transistor	2SC1124	2				

POWER CIRCUIT BOARD NA06428 General, U.S., Canadian, South African, Australian Models
 NA06429 European Model

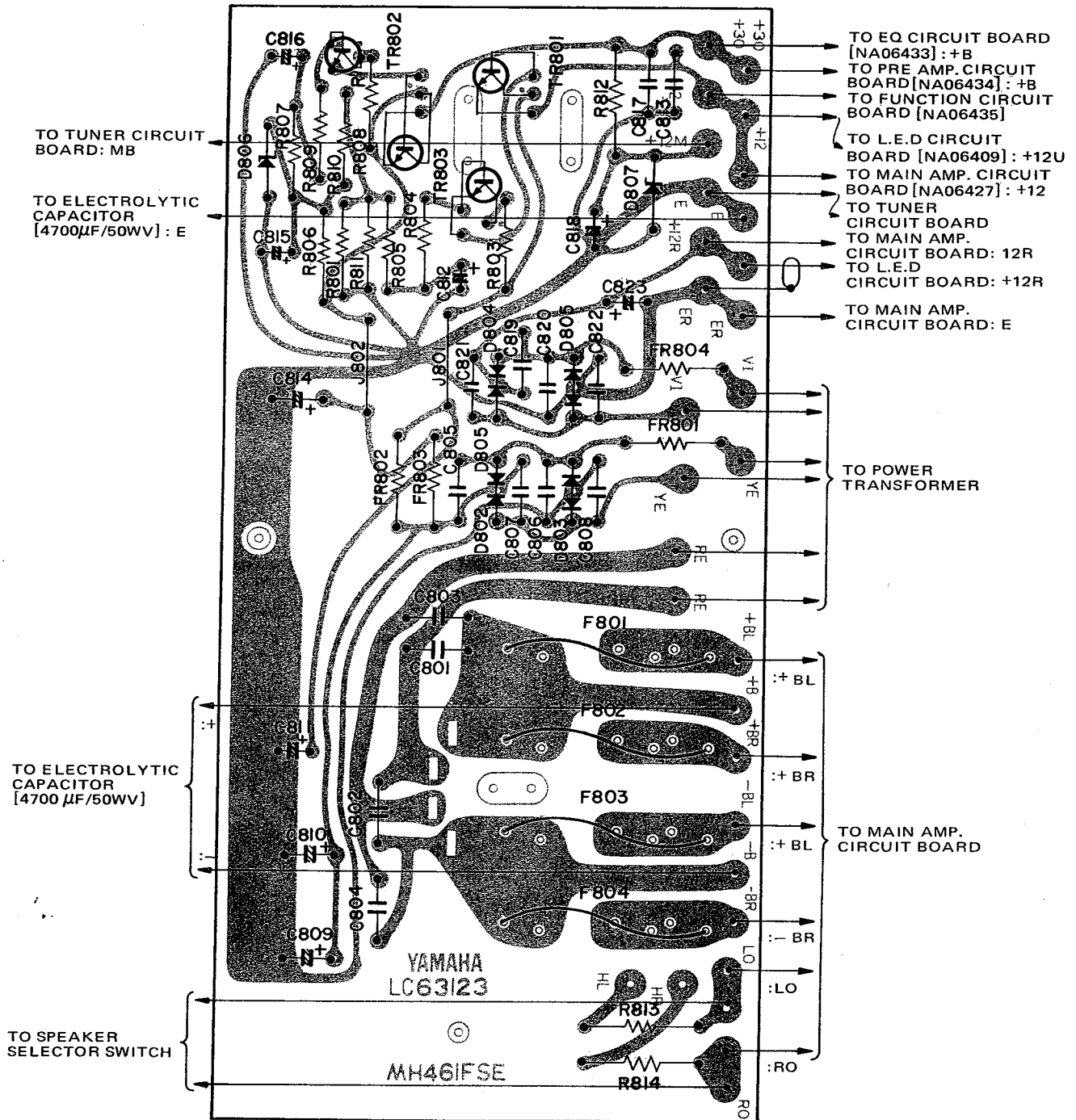

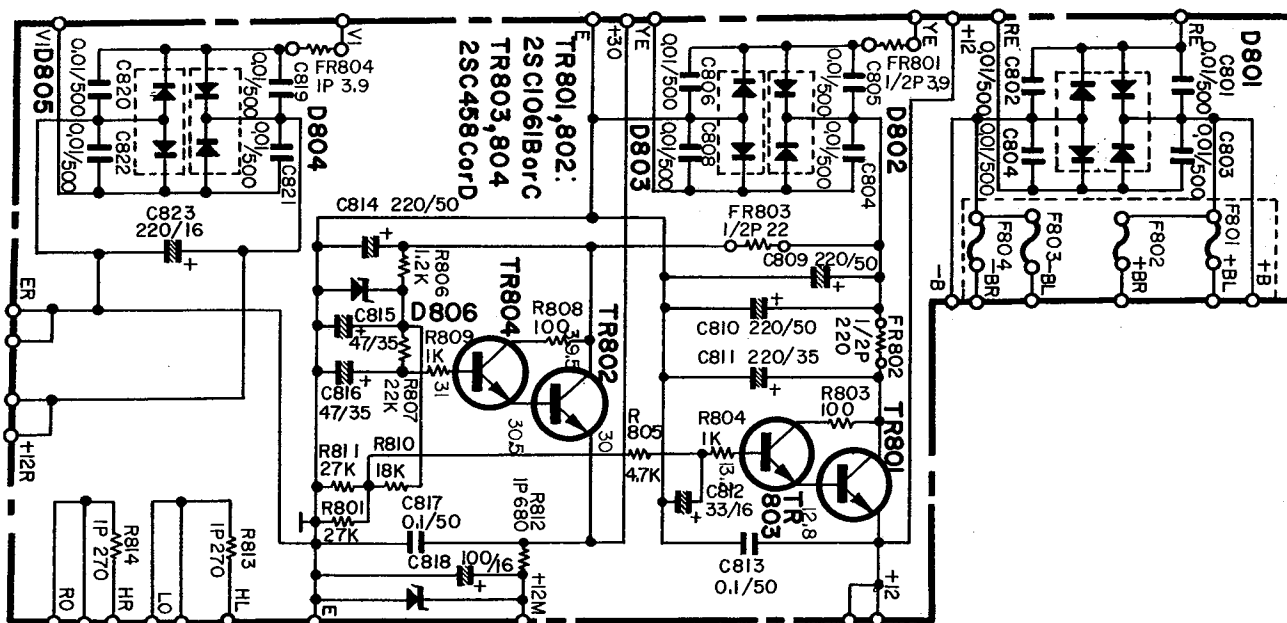

Ref. No.	Description	Ref. No.	Description
R 812	Metal-Oxide Film Resistor	D 807	Zener Diode
R 813	Metal-Oxide Film Resistor	F 801	UL Fuse
R 814	Metal-Oxide Film Resistor	F 802	UL Fuse
FR801	Fuse Resistor	F 803	UL Fuse
FR802	Fuse Resistor	F 804	UL Fuse
FR803	Fuse Resistor	F 801	S Fuse
FR804	Fuse Resistor	F 802	S Fuse
TR801	Transistor	F 803	S Fuse
TR802	Transistor	F 804	S Fuse
TR803	Transistor		
TR804	Transistor		
D 801	Diode		
D 802	Diode		
D 803	Diode		
D 804	Diode		
D 805	Diode		
D 806	Zener Diode		

6P PIN JACK CIRCUIT BOARD NA06416

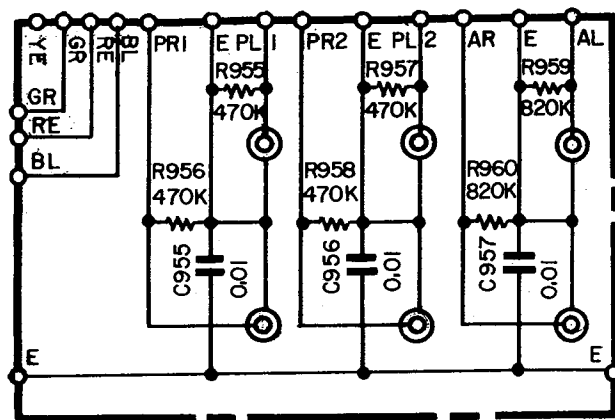
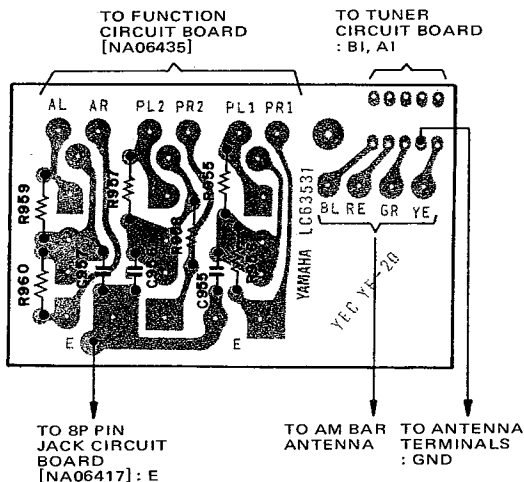

LIGHT EMITTING DIODE CIRCUIT BOARD NA06409

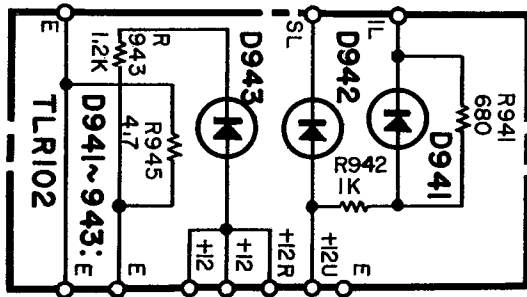
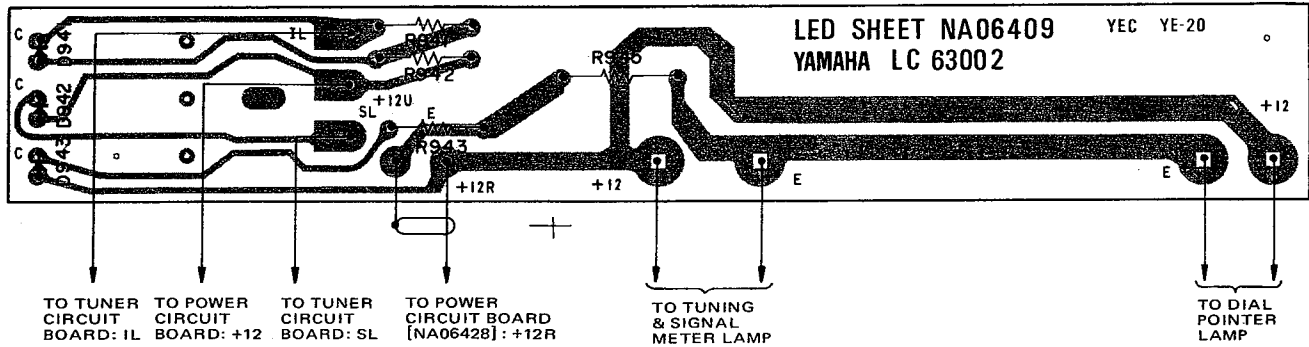

Ref. No.	Description		
R 945	Incombustible Resistor	4.7Ω	1W
D 941	Light Emitting Diode	TLR102	
D 942	Light Emitting Diode	TLR102	
D 943	Light Emitting Diode	TLR102	

COUPLER CIRCUIT BOARD NA06414
 General, U.S., Canadian,
 South African, Australian Models

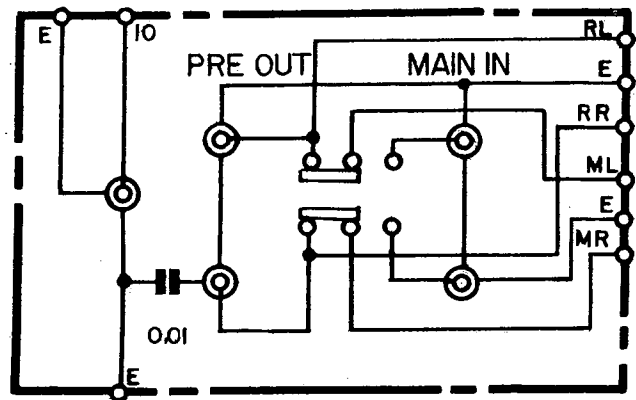
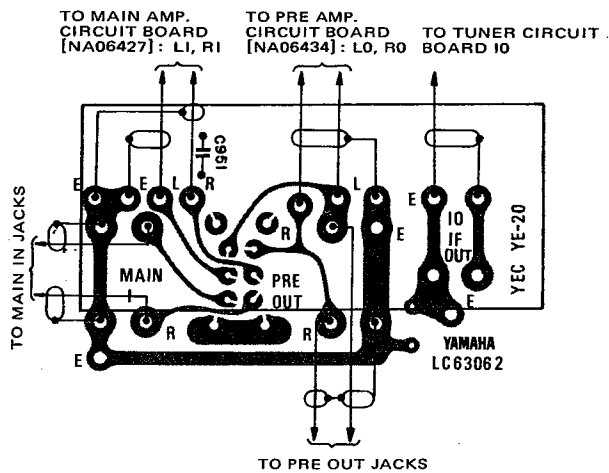

FUNCTION CIRCUIT BOARD NA06435

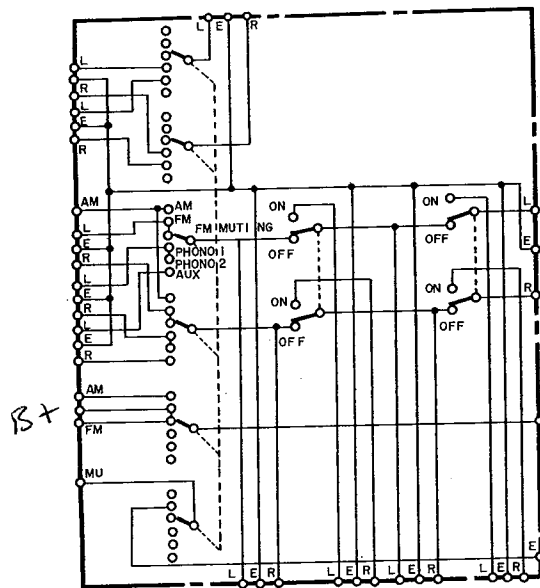
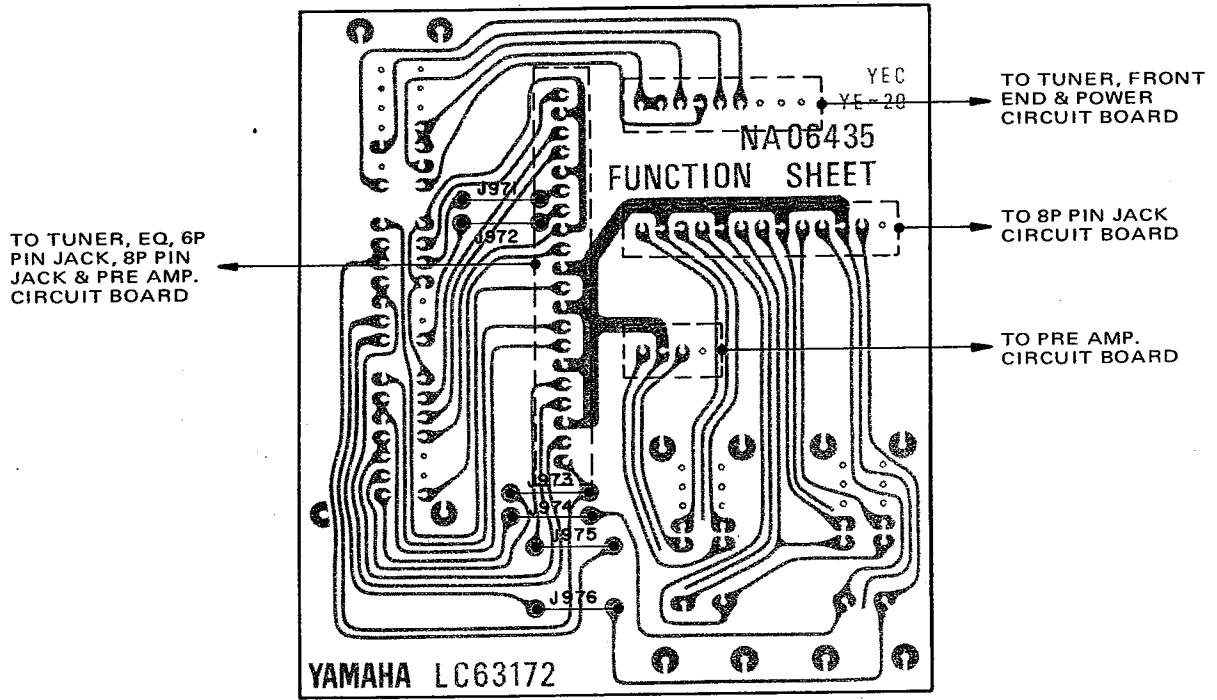

DIN CONNECTOR CIRCUIT BOARD (EUROPEAN MODEL ONLY)

NA06415
European Model

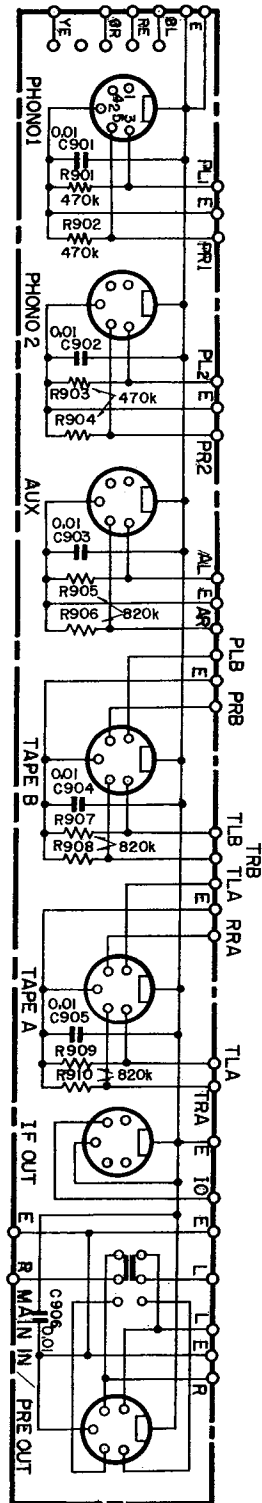
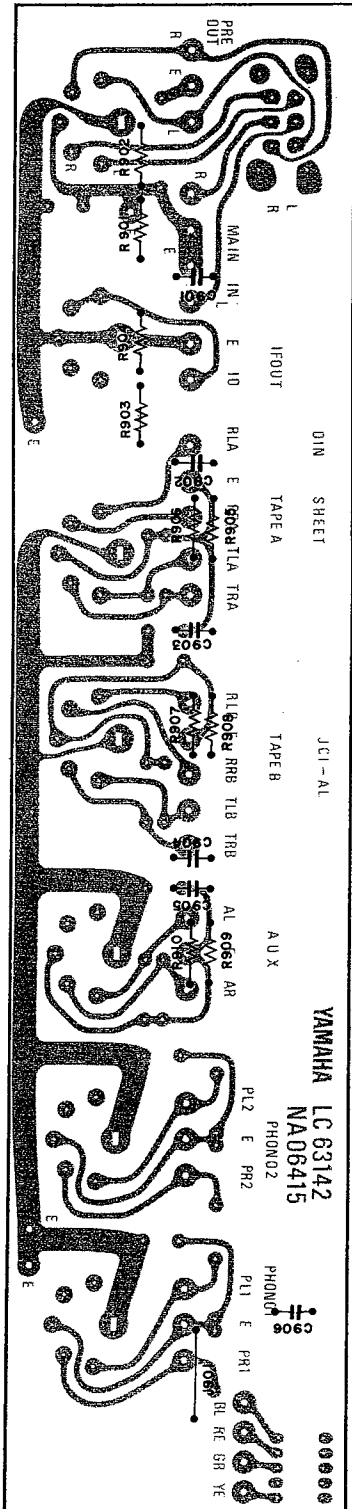

YAMAHA HI-FI STEREO RECEIVER CR-600

PARTS CATALOG

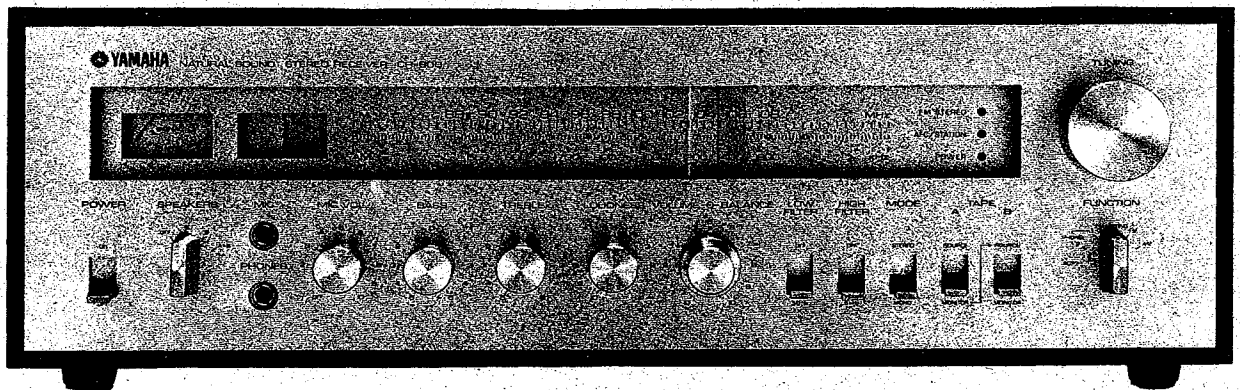

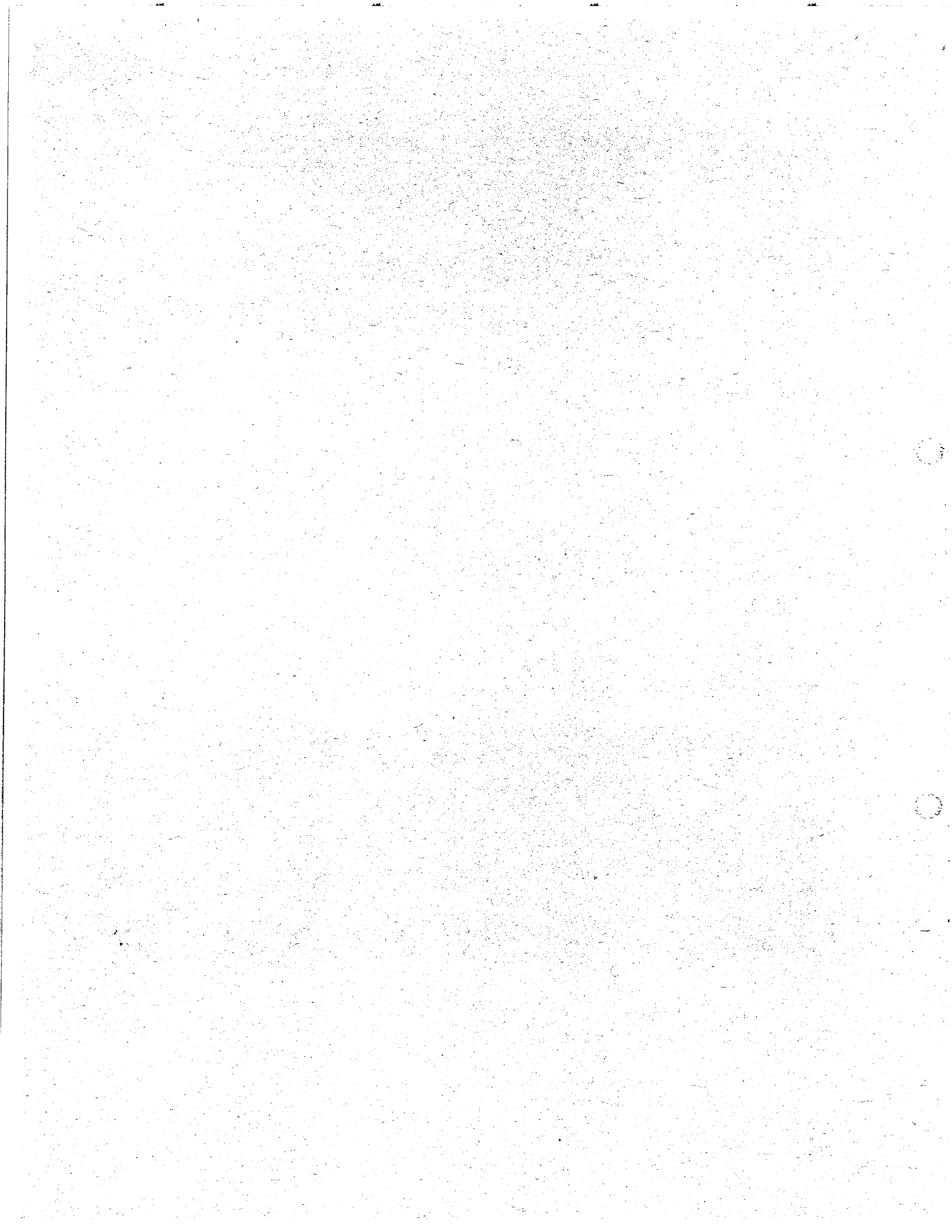

FRONT PANEL

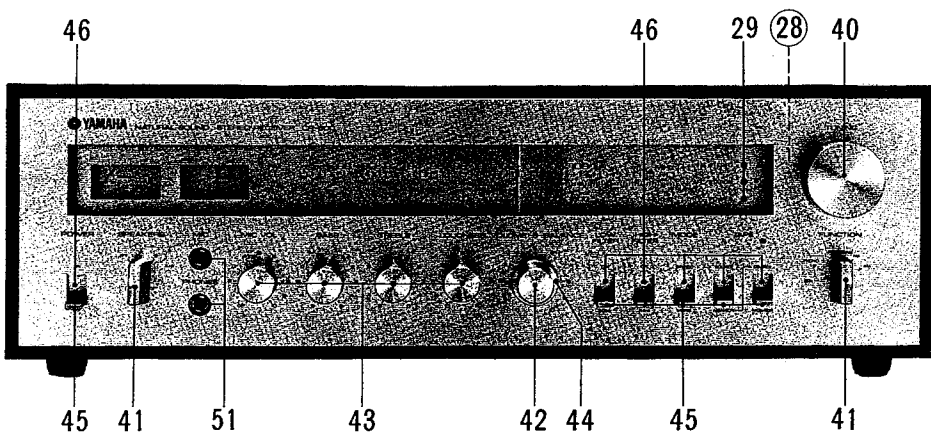

REAR PANEL (GENERAL MODEL)

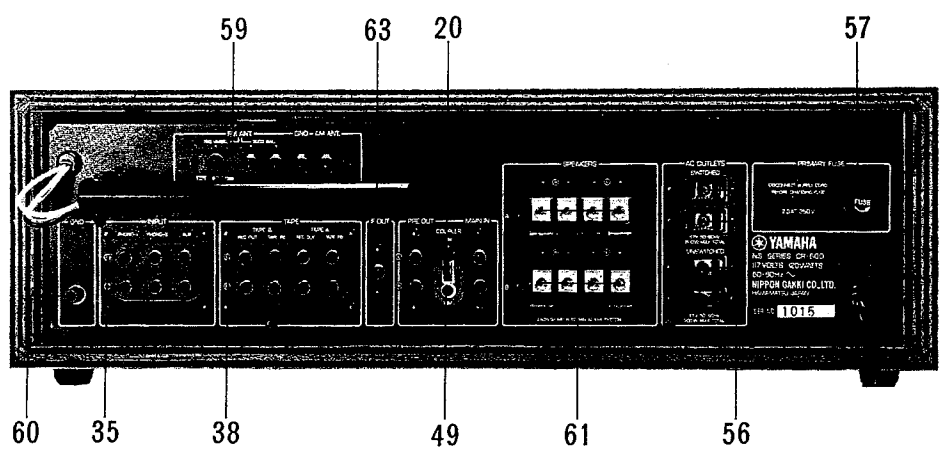

REAR PANEL (EUROPEAN MODEL)

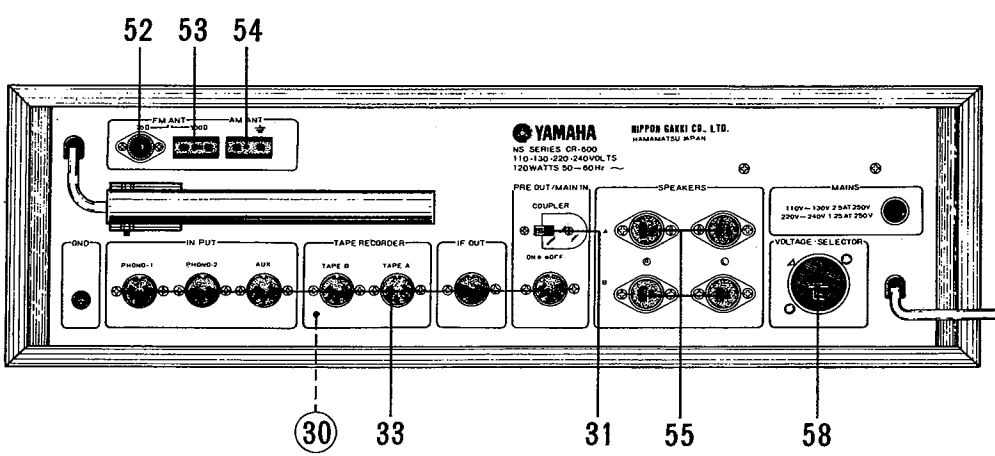

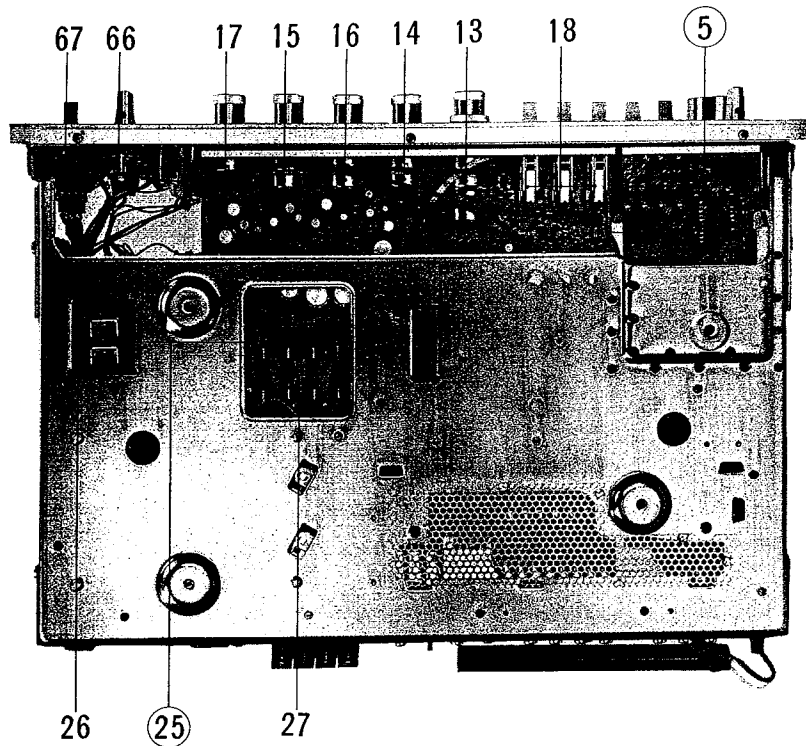
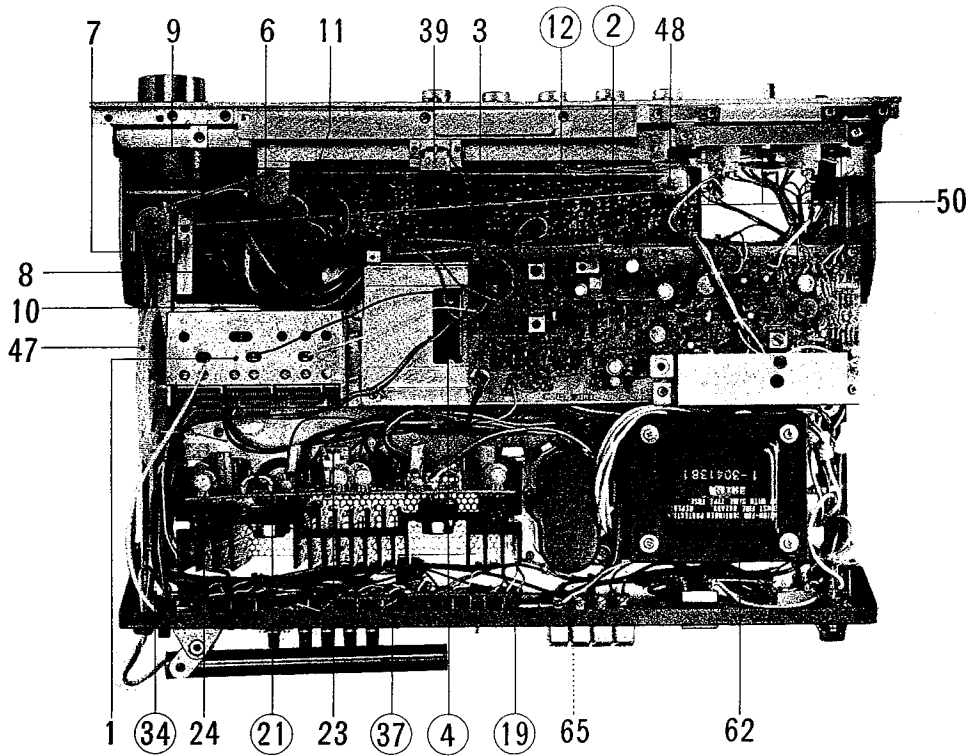

Ref. No.	Part No.	Description			Remarks	Common Models
1	PA00023	RF Pack	FL523U	R F パ ッ ク	except South African Model	
"	PA00024	RF Pack	FL523S	"	South African Model	
②	NA06431	Tuner Circuit board	# 63130	チューナーシート	U.S. & Canadian Models	
"	NA06432	- do. -		"	General, Australian & European Models	
"	NA06438	- do. -		"	South African Model	
		Carbon resistor	33 Ω ¼ W	カーボン抵抗		
		- do. -	56 Ω "	"		
		- do. -	100 Ω "	"		
		- do. -	220 Ω "	"		
		- do. -	270 Ω "	"		
		- do. -	330 Ω "	"		
		- do. -	390 Ω "	"		
		- do. -	470 Ω "	"		
		- do. -	560 Ω "	"		
		- do. -	1 K Ω "	"		
		- do. -	1.2 K Ω "	"		
		- do. -	1.5 K Ω "	"		
		- do. -	2.2 K Ω "	"		
		- do. -	2.7 K Ω "	"		
		- do. -	3.3 K Ω "	"		
		- do. -	3.9 K Ω "	"		
		- do. -	4.7 K Ω "	"		
		- do. -	5.6 K Ω "	"		
		- do. -	6.8 K Ω "	"		
		- do. -	8.2 K Ω "	"		
		- do. -	10 K Ω "	"		
		- do. -	12 K Ω "	"		
		- do. -	18 K Ω "	"		
		- do. -	22 K Ω "	"		
		- do. -	33 K Ω "	"		
		- do. -	56 K Ω "	"		
		- do. -	82 K Ω "	"		
		- do. -	100 K Ω "	"		

Ref. No.	Part No.	Description	Remarks	Common Models
		Carbon resistor 180 KΩ ¼ W	カーボン抵抗	
		- do. - 330 KΩ	"	
		- do. - 470 KΩ "	"	
		- do. - 1 MΩ "	"	
		Mylar capacitor 0.001 μF	マイラコンデンサ	
		- do. - 0.0018 μF	"	
		- do. - 0.0022 μF	"	
		- do. - 0.0056 μF	"	
		- do. - 0.0068 μF	"	
		- do. - 0.0082 μF	"	
		- do. - 0.01 μF	"	
		- do. - 0.012 μF	"	
		- do. - 0.033 μF	"	
		- do. - 0.056 μF	"	
		- do. - 0.1 μF	"	
		Ceramic capacitor 6 PF	セラミックコンデンサ	
		- do. - 47 PF	"	
		- do. - 68 PF	"	
		- do. - 150 PF	"	
		- do. - 820 PF	"	
		- do. - 0.001 μF	"	
		- do. - 0.022 μF	"	
		Electrolytic capacitor (Vert. type) 33 μF 6.3 WV	電解コンデンサ	
		- do. - (") 47 μF "	"	
		- do. - (") 100 μF "	"	
		- do. - (") 220 μF "	"	
		- do. - (") 10 μF 16 WV	"	
		- do. - (") 220 μF "	"	
		- do. - (") 1 μF 25 WV	"	
		- do. - (") 3.3 μF "	"	
		- do. - (") 4.7 μF "	"	
		Polystyren capacitor 360 PF	スチロロンコンデンサ	

Ref. No.	Part No.	Description		Remarks	Common Models
		Polystyren capacitor	2700 PF	スチロールコンデンサー	
		-- do. --	10000 PF	"	
		Tantalum capacitor	33 μ F 10 WV	タンタルコンデンサー	
		-- do. --	1 μ F 35 WV	"	
		-- do. --	3.3 μ F "	"	
GE10005	FM IFT	GE6019	F M I F T	except South African Model	
GE10006	-- do. --	GE6025	"	South African Model	
GE20007	MPX Coil	GE6056	M P X コイル		
GE20013	-- do. -- 47 MH		"		
GE20012	-- do. --	GE6069	"		
GE90001	AM-RE Coil	GE6067	A M - R F コイル		
GE10015	AM-OSC Coil	GE6013	A M O S C コイル		
GE10010	AM IFT	GE6030	A M I F T		
GE30001	RF Inductor	10 μ H	R F インダクター		
GE30011	RF Inductor	33 μ H	R F インダクター		
GE90013	AM Filter coil		A M フィルターコイル	except South African Model	
GE90014	-- do. --		"	South African Model	
GG00004	Ceramic Filter set	CF-10	セラミックフィルターセット		
GG00009	AM Ceramic Filter	FSN-1038	A M セラミックフィルター	except South African Model	
GG00010	-- do. --	FSN-1047	"	South African Model	
	Integrated circuit	LA1111	I C		
	-- do. --	LA3311	"		
	Diode	IS1555	ダイオード		
	-- do. --	SD-46	"		
HT41012	Variable resistor	B 470 Ω	ソリッド V R		
HT41007	-- do. --	B 10 K Ω	"		
	Transistor	2SC454 (B or C)	トランジスタ		
	-- do. --	2SC458 (C or D)	"		
	-- do. --	2SC460 (B or C)	"		

Ref. No.	Part No.	Description		Remarks	Common Models
3	LB10020	1 P Pin jack	SQ-3056	基板型ピンジャック	
④	NA06433	Equalizer Circuit board	#63151	イコライザーシート	
		Carbon resistor	270 Ω ¼ W	カーボン抵抗	
		- do. -	820 Ω "	"	
		- do. -	1.2 K Ω "	"	
		- do. -	1.5 K Ω "	"	
		- do. -	4.7 K Ω "	"	
		- do. -	8.2 K Ω "	"	
		- do. -	10 K Ω "	"	
		- do. -	47 K Ω "	"	
		- do. -	68 K Ω "	"	
		- do. -	180 K Ω "	"	
		- do. -	220 K Ω "	"	
		- do. -	270 K Ω "	"	
		Mylar capacitor	0.0039 μF	マイコンデンサー	
		- do. -	0.0047 μF	"	
		- do. -	0.0056 μF	"	
		- do. -	0.022 μF	"	
		Ceramic capacitor	6 PF	セラミックコンデンサー	
		- do. -	22 PF	"	
		- do. -	82 PF	"	
		- do. -	220 PF	"	
		- do. -	470 PF	"	
		Electrolytic capacitor (Vert. type)	47 μF 6.3 WV	電解コンデンサー	
		- do. - (")	33 μF 16 WV	"	
		- do. - (")	47 μF 25 WV	"	
		- do. - (")	220 μF 35 WV	"	
		Tantalum capacitor	4.7 μF 16 WV	タンタル固体コンデンサー	
		- do. -	1 μF 35 WV	"	

Ref. No.	Part No.	Description		Remarks	Common Models
		Integrated circuit	TA-7122P (B or A)	I C	
		Diode	IS1555	ダイオード	
⑤	NA06435	Function Circuit board	# 63172	ファンクション シート	
6	KA20017	Lever switch	SLA-34251	レバースイッチ	
7	KA50035	Rotary switch	SRZ-066	ロータリー スイッチ	
8	LB60035	CIS Connector socket	20 P	C I S ソケット	
9	LB60030	- do. -	13 P	"	
10	LB60025	- do. -	9 P	"	
11	LB40008	- do. -	4 P	"	
	LB10006	CIS Keying pin		C I S キー インゲピン	
⑫	NA06434	Pre-amp Circuit board	# 63161	プリシート	
		Carbon resistor	330 Ω ¼ W	カーボン抵抗	
		- do. -	470 Ω "	"	
		- do. -	680 Ω "	"	
		- do. -	820 Ω "	"	
		- do. -	1.2 K Ω "	"	
		- do. -	1.5 K Ω "	"	
		- do. -	1.8 K Ω "	"	
		- do. -	2.2 K Ω "	"	
		- do. -	4.7 K Ω "	"	
		- do. -	6.8 K Ω "	"	
		- do. -	8.2 K Ω "	"	
		- do. -	10 K Ω "	"	
		- do. -	15 K Ω "	"	
		- do. -	18 K Ω "	"	
		- do. -	33 K Ω "	"	
		- do. -	47 K Ω "	"	
		- do. -	68 K Ω "	"	

Ref. No.	Part No.	Description		Remarks	Common Models
		Carbon resistor	82 K Ω ¼ W	カーボン抵抗	
		- do. -	100 K Ω "	"	
		- do. -	150 K Ω "	"	
		- do. -	180 K Ω "	"	
		- do. -	220 K Ω "	"	
		- do. -	270 K Ω "	"	
		- do. -	330 K Ω "	"	
		- do. -	390 K Ω "	"	
		- do. -	470 K Ω "	"	
		- do. -	680 K Ω "	"	
		- do. -	820 K Ω "	"	
		- do. -	1 M Ω "	"	
		Fuse resistor	100 Ω ½ W	ヒューズ抵抗	
		- do. -	220 Ω "	"	
		Mylar capacitor	0.0027 μ F	マイラコンデンサ	
		- do. -	0.01 μ F	"	
		- do. -	0.022 μ F	"	
		- do. -	0.033 μ F	"	
		- do. -	0.039 μ F	"	
		- do. -	0.056 μ F	"	
		- do. -	0.18 μ F	"	
		- do. -	0.22 μ F	"	
		Ceramic capacitor	3 PF	セラミックコンデンサ	
		- do. -	5 PF	"	
		- do. -	6 PF	"	
		- do. -	100 PF	"	
		- do. -	150 PF	"	
		- do. -	180 PF	"	
		- do. -	560 PF	"	
		Electrolytic capacitor (V. type)	47 μ F 6.3 WV	電解コンデンサ	
		- do. -	(") 100 μ F "	"	
		- do. -	(") 10 μ F 16 WV	"	

Ref. No.	Part No.	Description	Remarks	Common Models
		Electrolytic capacitor (V. type) 10 μ F 25 WV	電解コンデンサ	
		- do. - (") 47 μ F "	"	
		- do. - (") 100 μ F "	"	
		- do. - (") 220 μ F 35 WV	"	
		BP capacitor (V. type) 3.3 μ F 25 WV	バイポーラン ケミコン	
		- do. - (") 1 μ F 50 WV	"	
		Tantalum capacitor 3.3 μ F 16 WV	タンタル固体 コンデンサ	
		- do. - 4.7 μ F "	"	
		- do. - 0.47 μ F 35 WV	"	
		- do. - 1 μ F "	"	
		- do. - 2.2 μ F "	"	
		Transistor 2SC458LG (D or C)	トランジスタ	
13	HS12031	Variable resistor HB 250K Ω , A 100K Ω	可変抵抗器	LEVEL CA-1000
14	HS12034	- do. - (with click) B20K Ω x 2	"	LOUDNESS "
15	HS12035	- do. - XZ25K Ω x 2	"	BASS CA-800
16	HS12036	- do. - XZ10K Ω x 2	"	TREBLE "
17	HS12037	- do. - (with SW.) A 50K Ω	"	MIC CR-800
18	KA20012	Lever switch SLA34202	レバースイッチ	CA-1000
⑱	NA06414	Coupler Circuit board # 63032	カブラーシート	except European Model
		Ceramic capacitor 0.01 μ F	セラミック コンデンサ	
	LB20066	2 P Pin jack (PC)	2 Pピンジャック	
	LB10008	1 P " (")	1 Pピンジャック	
20	KA40021	Slide switch SL222B4	スライドスイッチ	
㉑	NA06427	Main-amp Circuit board # 63111	メインシート	

Ref. No.	Part No.	Description		Remarks	Common Models
		Carbon resistor	10 Ω ¼ W	カーボン抵抗	
		- do. -	22 Ω "	"	
		- do. -	120 Ω "	"	
		- do. -	180 Ω "	"	
		- do. -	330 Ω "	"	
		- do. -	560 Ω "	"	
		- do. -	820 Ω "	"	
		- do. -	1 K Ω "	"	
		- do. -	1.2 K Ω "	"	
		- do. -	2.7 K Ω "	"	
		- do. -	3.9 K Ω "	"	
		- do. -	4.7 K Ω "	"	
		- do. -	6.8 K Ω "	"	
		- do. -	10 K Ω "	"	
		- do. -	15 K Ω "	"	
		- do. -	33 K Ω "	"	
		- do. -	68 K Ω "	"	
		- do. -	100 K Ω "	"	
		- do. -	150 K Ω "	"	
		- do. -	220 K Ω "	"	
		Metalised Oxidation resistor	1.2 K Ω 1 W	酸化金属抵抗	
		- do. -	1.5 K Ω "	"	
		- do. -	2.2 K Ω "	"	
		Metalised board resistor	0.47 Ω 5 W	金属板抵抗	
		Cement resistor	22 Ω 5 W	セメント抵抗	
		Fire proofing resistor	4.7 Ω 1 B	不燃性抵抗	
		Fuse resistor	100 Ω ½ W	ヒューズ抵抗	
		Mylar capacitor	0.068 μF	マイラコンデンサ	
		Ceramic capacitor	6 PF	セラミックコンデンサ	

Ref. No.	Part No.	Description	Remarks	Common Models
		Ceramic capacitor 150 PF	セラミックコンデンサ	
		- do. - 0.1 μ F	"	
		Electrolytic capacitor (KU type) 47 μ F 16 WV	電解コンデンサ	
		- do. - (V. type) 220 μ F 35 WV	"	
		- do. - (") 100 μ F 50 WV	"	
		Bi polar capacitor (Vert. type) 100 μ F 6.3 WV	バイポーラケミコン	
		- do. - (") 2.2 μ F 16 WV	"	
		- do. - (") 47 μ F "	"	
		- do. - (") 1 μ F 50 WV	"	
	HT41004	Variable resistor (SV10KR) B 4.7K Ω	ソリッドVR	
22	GD90005	Air-core coil 3 μ H	空芯コイル	
		Diode SD-46	ダイオード	
		- do. - 10D-1	"	
		- do. - IS1555	"	
		Zenner Diode WZ-120	ツェナーダイオード	
		Transistor 2SA572 (W-4.5)	トランジスタ	
		- do. - 2SA682 (O or Y)	"	
		- do. - 2SB531 (O or R)	"	
		- do. - 2SC458 (C or D)	"	
		- do. - 2SC1124 (-2)	"	
		- do. - 2SC1382 (Y or O)	"	
		- do. - 2SD371 (O or R)	"	
23	KC00009	Relay MX-2PO	リレー	
	BB06308	Transistor pusher	トランジスタ押え	
	LB30011	Transistor socket S2-110B-00	トランジスタソケット	
24	BA06480	Heat sink	放熱板	

Ref. No.	Part No.	Description		Remarks	Common Models
②	NA06428	Power supply Circuit board # 63122	電源シート	except European Model	
	NA06429	- do. -	"	European Model	
		Carbon resistor 100Ω ¼W	カーボン抵抗		
		- do. - 1KΩ "	"		
		- do. - 1.2KΩ "	"		
		- do. - 4.7KΩ "	"		
		- do. - 18KΩ "	"		
		- do. - 22KΩ "	"		
		- do. - 27KΩ "	"		
		Metalized oxidation resistor 270Ω 1W	酸化金属抵抗		
		- do. - 680Ω "	"		
	HZ00030	Fuse resistor 3.9Ω 1W	ヒューズ抵抗		
	HZ00016	- do. - 3.9Ω (300 mA) ½W	"		
	HZ00014	- do. - 220Ω ½W	"		
	HZ00029	- do. - 22Ω "	"		
		Ceramic capacitor 0.01μF 50 WV	セラミックコンデンサ		
		- do. - 0.1μF 500 WV	"		
		Electrolytic capacitor (Vert. type) 33μF 16 WV	電解コンデンサ		
		- do. - (") 220μF "	"		
		- do. - (") 47μF 35 WV	"		
		- do. - (") 220μF "	"		
		- do. - (") 220μF 50 WV	"		
		Diode 10DC-1	ダイオード		
		- do. - 10DC-1R	"		
		- do. - 10DC-2	"		
		- do. - 10DC-2R	"		
		- do. - 5B-2	"		
		Zenner diode WZ-120	ツェナーダイオード		
		- do. - WZ-310	"		

Ref. No.	Part No.	Description		Remarks	Common Models
		Transistor	2SC458 (C or D)	トランジスタ	
		- do. -	2SC1061 (B or C)	"	
26	BA06276	Heat sink		放熱板	CR-700
	LB20057	Fuse holder pin	SN-5053	ヒューズホルダピン	
27	KB00104	Fuse (UL listed)	3.0A 250V	ヒューズ (UL規格)	except European Model
	KB00057	Miniature fuse	3.15A 250V	ミニチュアヒューズ	European Model
⑳	NA06409	L.E.D. Circuit board	#63002	LEDシート	
		Carbon resistor	680Ω ¼W	カーボン抵抗	
		- do. -	1KΩ "	"	
		- do. -	1.2KΩ "	"	
		Fire proofing resistor	4.7Ω 1W	不燃性抵抗	
29	IF00029	Light emitting diode	TLR-102	発光ダイオード	
	CB06864	Indicator holder		インジケータホルダ	
	CB06888	Plastic rivet		プラスチックリベット	
㉑	NA06415	DIN Circuit board	#63142	DINシート	European Model
		Carbon resistor	470KΩ ¼W	カーボン抵抗	
		- do. -	820KΩ "	"	
		Ceramic capacitor	0.01µF	セラミックコンデンサ	
31	KA40021	Slide switch	SL222B4	スライドスイッチ	
32	LB50005	CIS socket	5P	CIS5Pソケット	
	LB10016	CIS Keyins pin		CISキーイングピン	
33	LB50009	DIN Connector	5P	DIN5Pコネクタキーバン型	

Ref. No.	Part No.	Description		Remarks	Common Models
③④	NA06416	6 P pin jack Circuit board	#63531	6 Pピンジャックシート	
		Carbon resistor	470 K Ω	カーボン抵抗	
		- do. -	820 K Ω	"	
		Ceramic capacitor	0.01 μ F	セラミックコンデンサ	
35	LB60038	6 P pin jack		6 Pピンジャック	
36	LB50005	CIS socket 5 P		CIS 5 Pソケット	
	LB10016	CIS Keying pin		CIS キーイングピン	
③⑦	NA06417	8 P pin jack Circuit board	#63541	8 Pピンジャックシート	
		Carbon resistor	820 K Ω 1/4 W	カーボン抵抗	
		Ceramic capacitor	0.01 μ F	セラミックコンデンサ	
38	LB60039	8 P pin jack		8 Pピンジャック	
	NB06784	Panel unit		パネルユニット	
	NB06786	Dial scale panel unit		目盛板ユニット	
39	NB06849	Dial pointer unit		ダイヤル指針ユニット	
	NB06776	Meter unit		メーターユニット	CR-1000
	AA06490	Dial spring		ダイヤルスプリング	SS-40
40	BA06438	Knob (tuning)		チューニングツマミ	CR-400
41	BA06441	Knob (switch)		スイッチツマミ	"
42	BA06444	Double knob		ダブルツマミ	LEVEL CA-1000
43	BA06445	Knob		ツマミ	CR-400
44	BA06447	Double knob		ダブルツマミ	BALANCE CA-1000
45	CB06857	Knob (Lever switch)		レバースイッチ用ツマミ	"
46	CB06872	Switch apron 15 X 29		スイッチフロン	"
47	CB06054	Pully for variable capacitor		バリコンプーリー	S-3

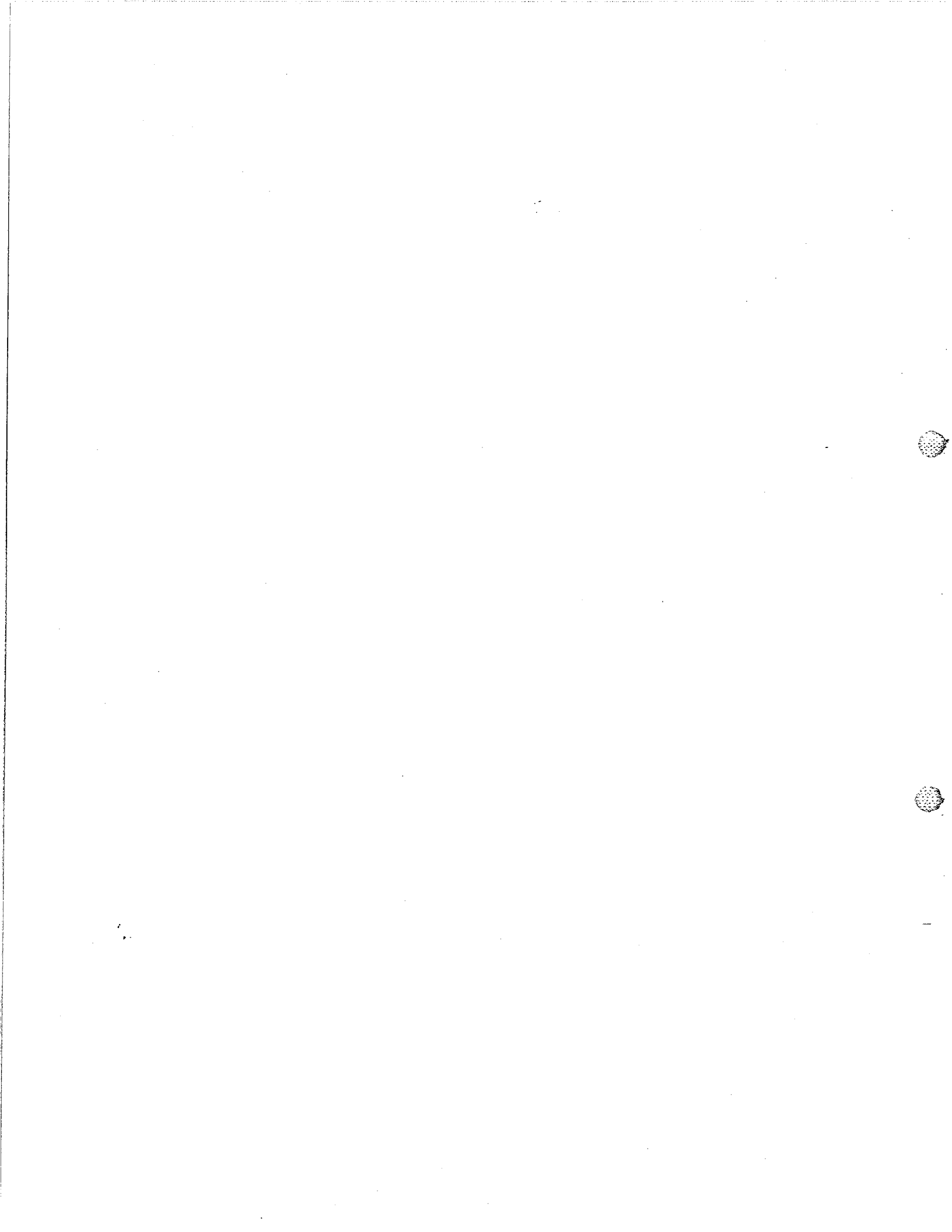

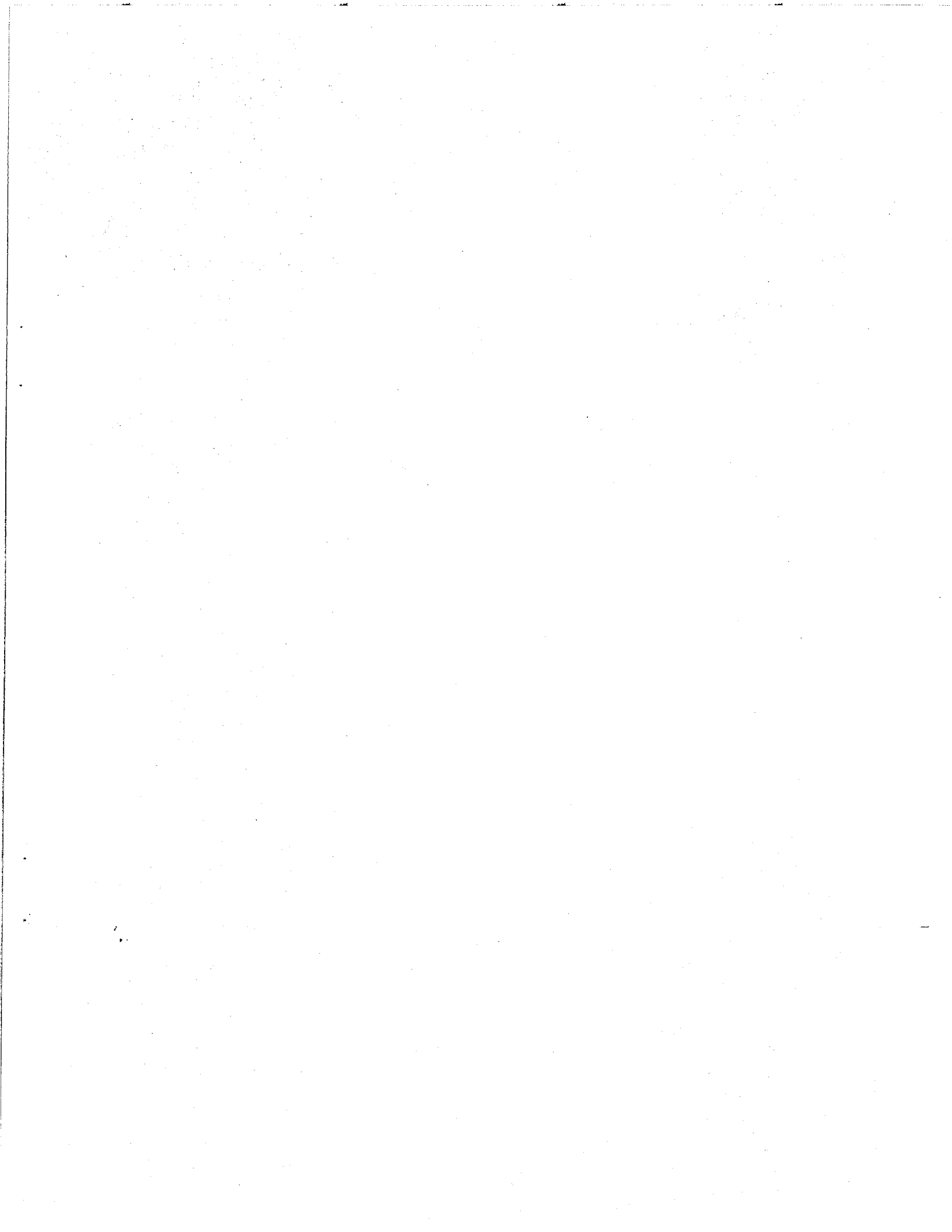

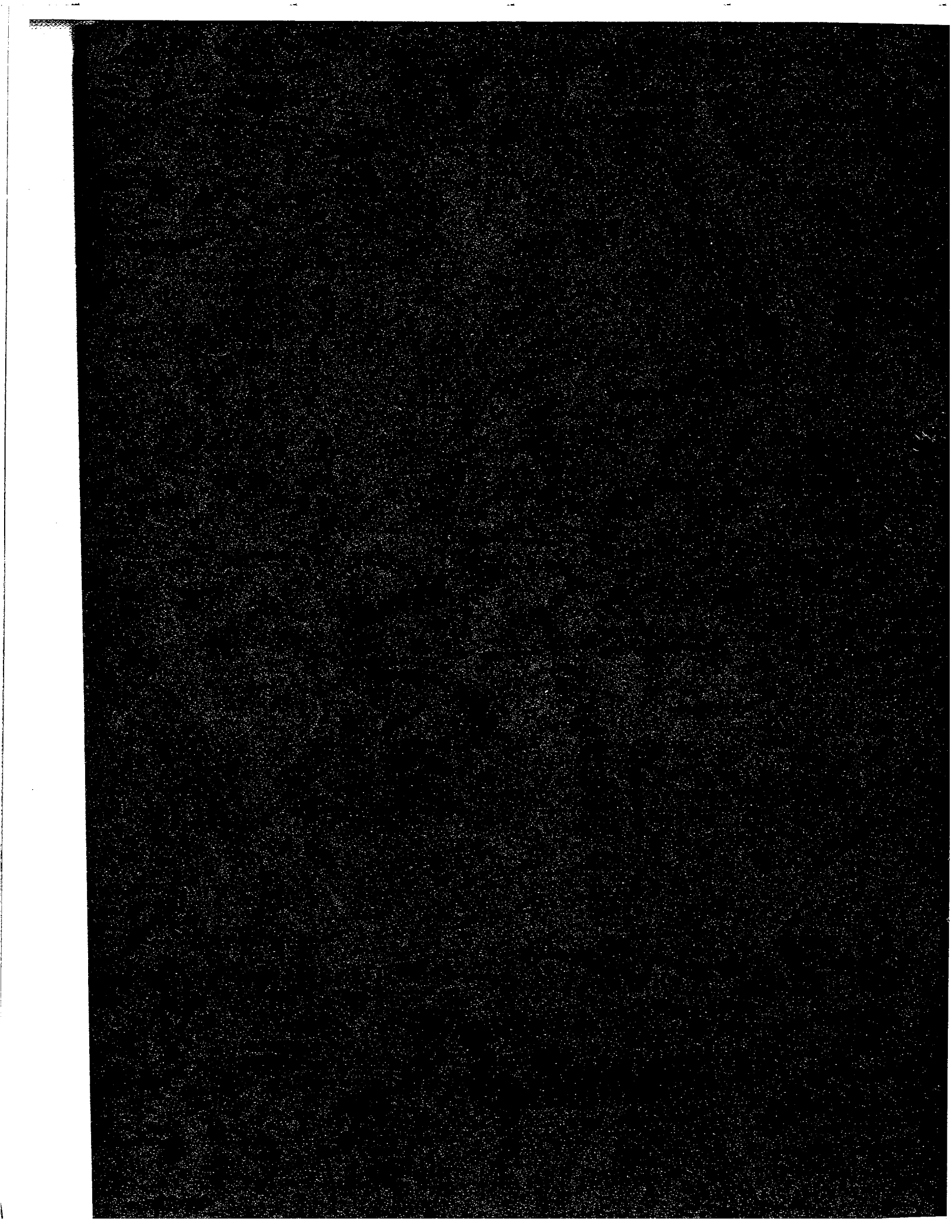

YAMAHA Hi-Fi STEREO

SERVICE MANUAL

98

MODEL **CR-600**

 **YAMAHA**

THE UNIVERSITY OF CHICAGO

PHYSICS DEPARTMENT

PHYSICS DEPARTMENT

PHYSICS DEPARTMENT

PHYSICS DEPARTMENT

CONTENTS

NEW PARTS	1
CIRCUIT DESCRIPTION	2
SPECIFICATIONS	3
EXTERNAL VIEW	
FRONT PANEL	4
REAR PANEL (U.S. & CANADIAN MODELS)	4
REAR PANEL (EUROPEAN MODEL)	4
INTERNAL VIEW	6
PARTIAL DISASSEMBLY	
CABINET REMOVAL	7
FRONT PANEL REMOVAL	7
DROPPING THE SUB CHASSIS UNIT	7
DROPPING THE REAR PANEL	8
PRE AMP CIRCUIT BOARD REMOVAL	8
FUNCTION CIRCUIT BOARD REMOVAL	9
POWER SWITCH REMOVAL	9
TUNING & SIGNAL METER REMOVAL	9
POWER CIRCUIT BOARD REMOVAL	9
EQ. CIRCUIT BOARD REMOVAL	10
MAIN AMP CIRCUIT BOARD REMOVAL	10
TUNER CIRCUIT BOARD REMOVAL	10
DIAL MECHANISM	10
MEASUREMENT AND ADJUSTMENT	11
PRINTED CIRCUIT BOARD	
TUNER CIRCUIT BOARD	18
EQ AMP CIRCUIT BOARD	19
8P PIN JACK CIRCUIT BOARD	19
PRE AMP CIRCUIT BOARD	20
6P PIN JACK CIRCUIT BOARD	20
COUPLER CIRCUIT BOARD	20
MAIN AMP CIRCUIT BOARD	21
POWER CIRCUIT BOARD	21
LIGHT EMITTING DIODE CIRCUIT BOARD	21
FUNCTION CIRCUIT BOARD	22
DIN CONNECTOR CIRCUIT BOARD (EUROPEAN MODEL ONLY)	22
OVERALL SCHEMATIC DIAGRAM	23
BLOCK DIAGRAM	25
PARTIAL CHANGES MADE ACCORDING TO DESTINATION	26
PARTS CATALOG	27

NEW PARTS

Refer to CR-400's SERVICE MANUAL P1, 2.

CIRCUIT DESCRIPTION

MUTING CIRCUIT

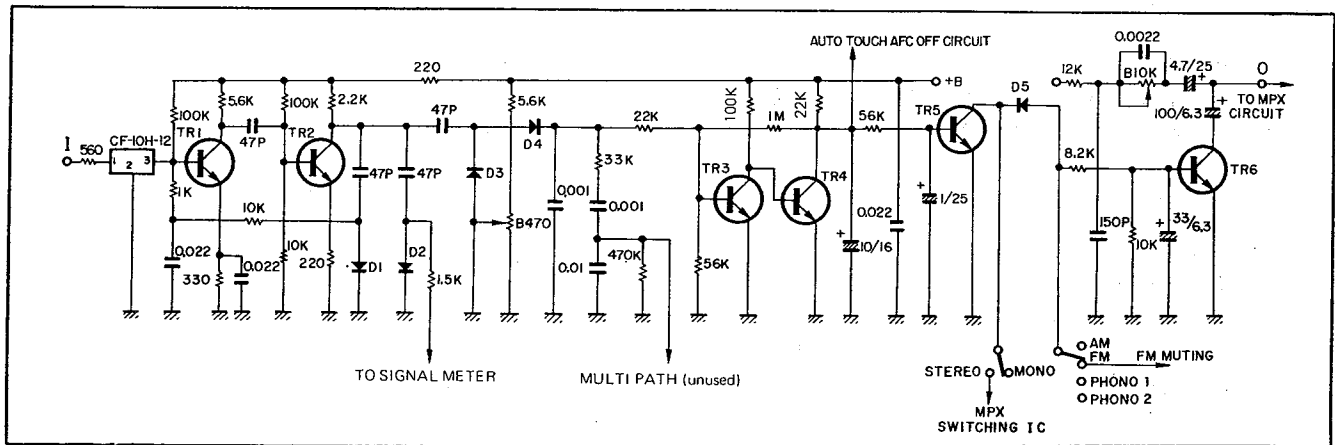

1. When no signal is received during FM mode (or if the received signal is very weak), Tr3 is OFF, Tr4 is ON and Tr5 is OFF due to a lack of signal received at the I terminal. +B electric potential is fed to the Tr6 base, so that Tr6 goes ON. The FM signal is shorted to the ground, and there is output power at O terminal, and no noise between broadcasting stations.

2. When signals are received during FM mode they enter through the terminals and are amplified by Tr1 and Tr2, rectified by D3 and D4, and then fed to the base of Tr3. This switches Tr3 ON and Tr4 OFF. Because of this, +B potential is fed to the base of Tr5, switching Tr5 ON. The same +B potential fed to the base of Tr6 shorts it and switches it OFF, so that output power appears at the O terminal.

AUTO TOUCH AFC OFF

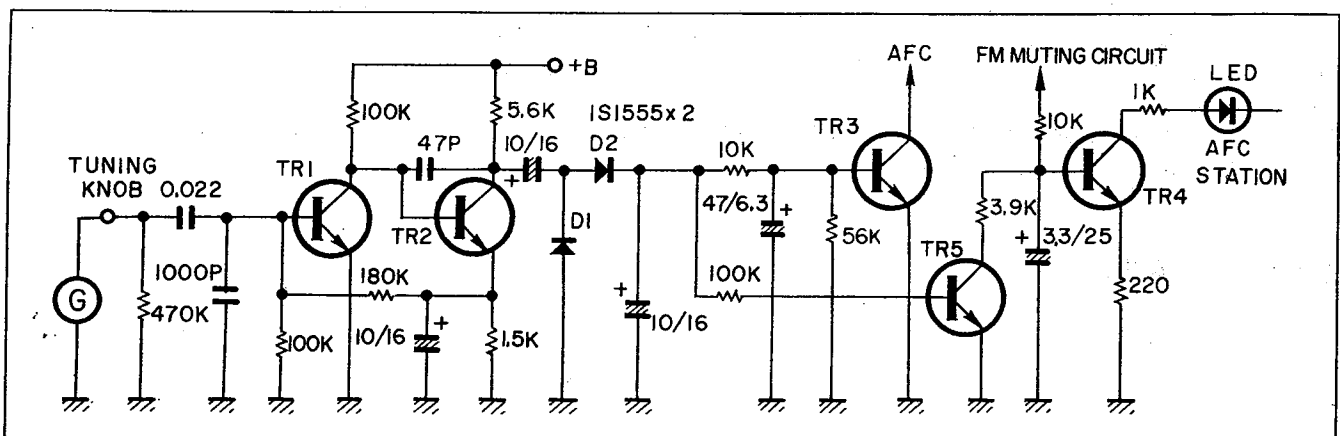

1. Touch the Tuning knob.
 2. The body's electric potential is amplified by Tr1 and Tr2.
 3. D1 and D2 rectify the Tr2 output voltage to get DC voltage.

4. This DC voltage is fed to Tr3, which switches it ON, then the AFC signal is shorted.
 5. At the same time, this DC voltage rapidly lowers the Tr5 impedance, thus reducing the Tr4 base potential. It also lowers the LED brightness.

SPECIFICATIONS

AUDIO SECTION

POWER OUTPUT

Dynamic Power	(IHF) 140 watts (4 Ω) 100 watts (8 Ω)
Continuous RMS Power (each channel driven)	50/50 watts (4 Ω) at 1,000Hz 40/40 watts (8 Ω) at 1,000Hz
Continuous RMS Power (both channels driven)	45 + 45 watts (4 Ω) at 1,000Hz 35 + 35 watts (8 Ω) at 1,000Hz
Continuous RMS Power (both channels driven)	35 + 35 watts (4 Ω) at 20 to 20,000Hz 30 + 30 watts (8 Ω) at 20 to 20,000Hz

TOTAL HARMONIC DISTORTION

Power Amplifier Only	less than 0.1% at rated power less than 0.04% at 1 watt
Preamplifier Only	(PHONO to PRE OUT) less than 0.1% at rated power (AUX to PRE OUT) less than 0.02% at rated power
Overall (AUX to Power Output)	less than 0.1% at rated power

INTERMODULATION DISTORTION

Power Amplifier Only	(70Hz:7,000Hz=4:1 SMPTE method) less than 0.1% (8 Ω) at rated power less than 0.05% (8 Ω) at 1 watt
Overall (AUX to Power Output)	less than 0.1% (8 Ω) at rated output

POWER BANDWIDTH (IHF, distortion 0.5% const.)

5 to 70,000Hz	
FREQUENCY RESPONSE (at 1 watt)	
Overall (AUX, TAPE PB to Power Output)	10 to 50,000Hz + 0.5dB, -1dB
Overall (MIC to Power Output)	100 to 10,000Hz + 0.5dB, -6dB

Power Amplifier Only

10 to 100,000Hz +0dB, -1dB	
RIAA Deviation (30 to 15,000Hz)	+0.5dB, -0.5dB

LOAD IMPEDANCE

4 to 16 Ω	
DAMPING FACTOR (8 Ω)	70 at 1,000Hz
CHANNEL SEPARATION (at rated power, 1,000Hz)	Power Amplifier Only 60dB

Power Amplifier Only

Overall from PHONO 1, 2	50dB
Overall from AUX, TAPE PB	50dB
Overall from MIC	50dB

HUM AND NOISE (IHF, Closed Circuit A Network)

Overall from PHONO 1, 2	better than 75dB
Overall from MIC	better than 70dB

Overall from AUX, TAPE PB

Power Amplifier Only	better than 90dB
Volume at Minimum	better than 90dB

INPUT SENSITIVITY AND IMPEDANCE

	(at rated power, 1,000Hz)
PHONO 1	3mV (50k Ω)
PHONO 2	3mV (50k Ω)
PHONO 1, 2 Max. Input Capability	135mV (T.H.D. 0.1%)
MIC	3mV (50k Ω)
MIC Max. Input Capability	450mV (T.H.D. 0.3%)
AUX	150mV (45k Ω)
TAPE PB A, B	150mV (45k Ω)
MAIN IN	775mV (45k Ω)

OUTPUT LEVEL AND IMPEDANCE

	(at rated power, 1,000Hz)
TAPE REC OUT A, B	150mV (2k Ω)
PRE OUT	775mV (2k Ω)
	3,000mV (Max. Output T.H.D. 0.1%)

TONE CONTROLS

BASS	+10dB, -10dB at 50Hz
TREBLE	+10dB, -10dB at 10,000Hz

FILTERS

LOW	-3dB at 50Hz (12dB/oct.)
HIGH	-3dB at 8,000Hz (6dB/oct.)

LOUDNESS CONTROL

	(Continuous Loudness Volume at Minimum)
	+10dB at 100Hz, +5dB at 10,000Hz

TUNER SECTION

FM:

Tuning Range	88 to 108MHz
Usable Sensitivity (IHF)	2.0 μ V
Quieting Slope	55dB at 5 μ V 60dB at 10 μ V
Image Frequency Rejection	90dB
IF Rejection	95dB
Spurious Response Rejection	95dB
AM Rejection	55dB
Capture Ratio	1.5dB
Alternate Channel Selectivity (IHF)	75dB
Signal-Noise Ratio	70dB
Total Harmonic Distortion	MONO 0.3% at 400Hz STEREO 0.5% at 400Hz
Stereo Separation	40dB at 400Hz 28dB at 50 to 10,000Hz

Frequency Response	+1.0dB, -1.0dB at 50 to 10,000Hz +1.5dB, -3.0dB at 20 to 15,000Hz
--------------------	--

Sub-Carrier Suppression

40dB

Muting Override Signal Level

10 μ V

Antenna Impedance

300 Ω balanced

IF Out Level and Impedance

75 Ω unbalanced
400mV/1k Ω

AM:

Tuning Range	525 to 1,605kHz
--------------	-----------------

Usable Sensitivity (IHF)

52dB/m

Signal-to-Noise Ratio

45dB at 80dB/m

Image Frequency Rejection

70dB at 1,000kHz

Selectivity

30dB at 1,000kHz

IF Rejection

60dB at 1,000kHz

Spurious Response Rejection

70dB at 1,000kHz

Total Harmonic Distortion

0.8% at 80dB/m

GENERAL

Semiconductors	411Cs; 2 MOS FETs; 59 Transistors; 3 LEDs; 33 Diodes; 3 Zener Diodes
----------------	---

Power Source	AC 110, 117, 130, 220, 240V, 50/60Hz
--------------	--------------------------------------

POWER CONSUMPTION

Rated	160 watts
-------	-----------

U.S. MODEL	160 watts
------------	-----------

CANADIAN MODEL	160 watts
----------------	-----------

EXCEPT U.S. & CANADIAN MODEL	120 watts
------------------------------	-----------

Max.	200 watts
------	-----------

AC OUTLETS

Switched	2 (total 200 watts)
----------	---------------------

Unswitched	2 (total 200 watts)
------------	---------------------

DIMENSIONS

474mm (18 $\frac{3}{4}$ " W x 158mm (6 $\frac{1}{8}$ " H x
--

300mm (11 $\frac{3}{8}$ " D

WEIGHT	13kg (28.7 lbs.)
--------	------------------

Specifications subject to change without notice.

EXTERNAL VIEW

FRONT PANEL

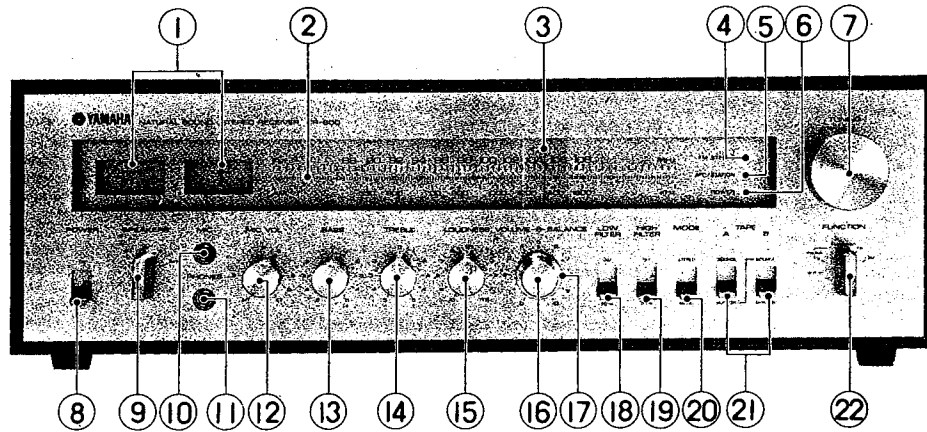

REAR PANEL (U.S. & CANADIAN MODELS)

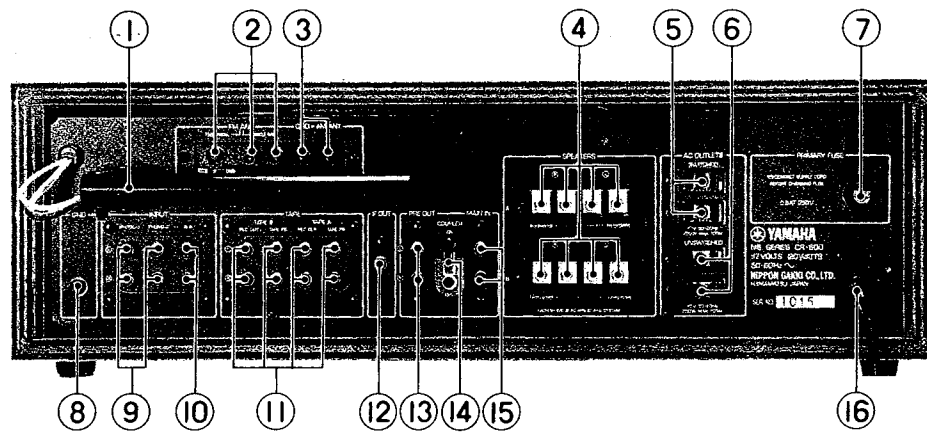

REAR PANEL (EUROPEAN MODEL)

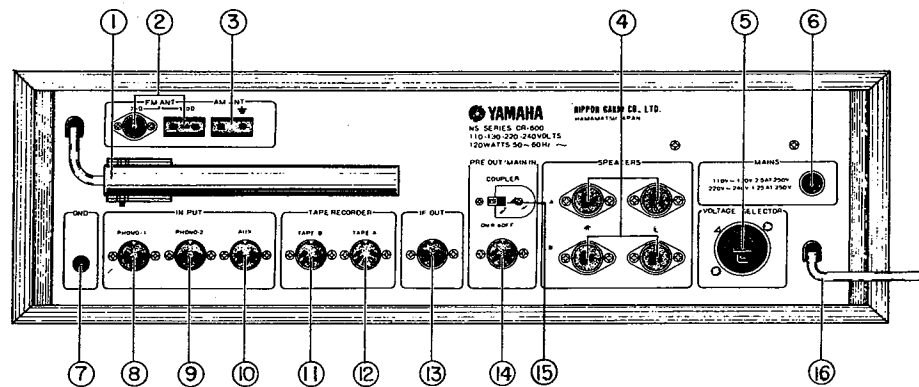

FRONT PANEL

- | | | | |
|---|-------------------------|---|--------------------|
| ① | SIGNAL & TUNING METERS | ⑫ | MIC VOLUME CONTROL |
| ② | DIAL SCALE | ⑬ | BASS CONTROL |
| ③ | DIAL POINTER | ⑭ | TREBLE CONTROL |
| ④ | FM STEREO INDICATOR | ⑮ | LOUDNESS CONTROL |
| ⑤ | AFC/STATION INDICATOR | ⑯ | VOLUME CONTROL |
| ⑥ | POWER LAMP | ⑰ | BALANCE CONTROL |
| ⑦ | TUNING KNOB | ⑱ | LOW FILTER SWITCH |
| ⑧ | POWER SWITCH | ⑲ | HIGH FILTER SWITCH |
| ⑨ | SPEAKER SELECTOR SWITCH | ⑳ | MODE SWITCH |
| ⑩ | MIC JACK | ㉑ | TAPE SWITCH |
| ⑪ | HEADPHONE JACK | ㉒ | FUNCTION SWITCH |

REAR PANEL (U.S. & CANADIAN MODELS)

- | | | | |
|---|------------------------|---|----------------------------|
| ① | AM FERRITE BAR ANTENNA | ⑨ | PHONO 1, 2 INPUT JACKS |
| ② | FM ANTENNA TERMINAL | ⑩ | AUX INPUT JACKS |
| ③ | AM ANTENNA TERMINAL | ⑪ | TAPE 1, 2 REC OUT/PB JACKS |
| ④ | SPEAKER TERMINALS | ⑫ | IF OUT JACK |
| ⑤ | AC OUTLET (SWITCHED) | ⑬ | PRE OUT JACKS |
| ⑥ | AC OUTLET (UNSWITCHED) | ⑭ | COUPLER SWITCH |
| ⑦ | PRIMARY FUSE | ⑮ | MAIN IN JACKS |
| ⑧ | GROUND TERMINAL | ⑯ | AC CORD |

REAR PANEL (EUROPEAN MODEL)

- | | | | |
|---|-------------------------|---|---------------------------|
| ① | AM FERRITE BAR ANTENNA | ⑨ | PHONO, 2 INPUT CONNECTOR |
| ② | FM ANTENNA CONNECTOR | ⑩ | AUX CONNECTOR |
| ③ | AM ANTENNA CONNECTOR | ⑪ | TAPE B CONNECTOR |
| ④ | SPEAKER CONNECTOR | ⑫ | TAPE A CONNECTOR |
| ⑤ | VOLTAGE SELECTOR | ⑬ | IF OUT CONNECTOR |
| ⑥ | PRIMARY FUSE | ⑭ | PRE OUT/MAIN IN CONNECTOR |
| ⑦ | GROUND TERMINAL | ⑮ | COUPLER SWITCH |
| ⑧ | PHONO 1 INPUT CONNECTOR | ⑯ | AC CORD |

INTERNAL VIEW

TOP VIEW

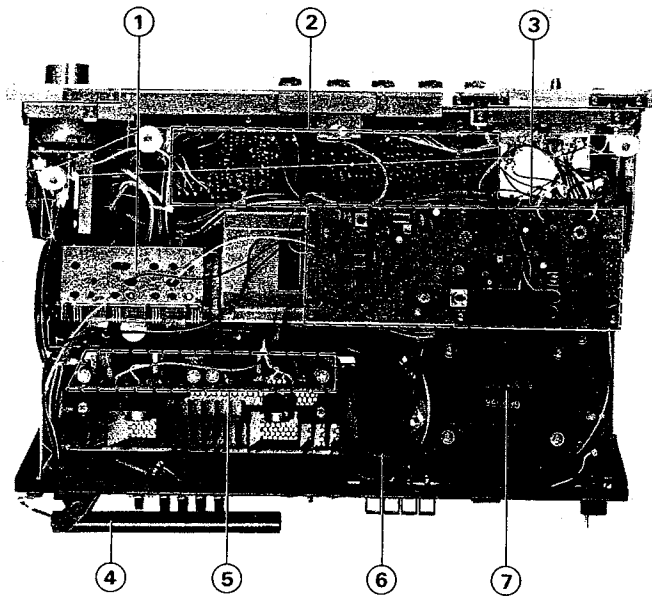

1. POWER TRANSFORMER (GA60564)
2. ELECTROLYTIC CAPACITOR (4,700 μ F/50WV)
3. MAIN AMP CIRCUIT BOARD (NA06427)
4. AM FERRITE BAR ANTENNA
5. TUNER CIRCUIT BOARD (NA06431)
U.S. & CANADIAN MODELS (NA06432)
GENERAL, AUSTRALIAN & EUROPEAN MODELS (NA06438)
SOUTH AFRICAN MODEL
6. PRE AMP CIRCUIT BOARD (NA06434)
7. FRONT END PACK
FL532U : EXCEPT SOUTH AFRICAN MODEL
FL523S : SOUTH AFRICAN MODEL

BOTTOM VIEW

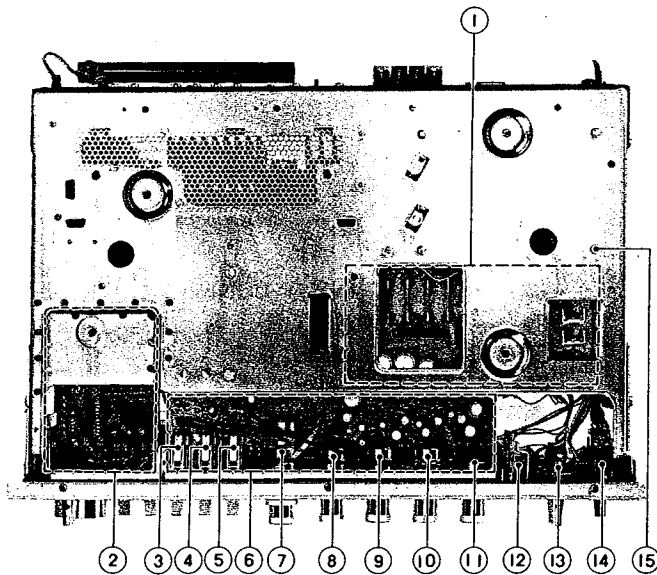

1. POWER CIRCUIT BOARD (NA06428)
EXCEPT EUROPEAN MODEL (NA06429)
EUROPEAN MODEL
2. FUNCTION CIRCUIT BOARD (NA06435)
3. MODE SWITCH
4. HIGH FILTER SWITCH
5. LOW FILTER SWITCH
6. PRE AMP CIRCUIT BOARD
7. VARIABLE RESISTOR (VOLUME & BALANCE CONTROL : HB250k Ω x 2, A100k Ω x 2)
8. VARIABLE RESISTOR (LOUDNESS CONTROL : B20k Ω x 2)
9. VARIABLE RESISTOR (TREBLE CONTROL : XZ10k Ω x 2)
10. VARIABLE RESISTOR (BASS CONTROL : XZ25k Ω x 2)
11. VARIABLE RESISTOR (MIC CONTROL : A50k Ω with switch)
12. HEADPHONE JACK
13. SPEAKER SELECTOR SWITCH
14. POWER SWITCH
15. CHASSIS

PARTIAL DISASSEMBLY

BEFORE DISASSEMBLY

- The screwdriver for each screw should match the screw size. If you use a smaller or larger size it will damage the groove.
- If you use excessive force on the printed circuit board it will crack or cut the print wiring, so be careful.
- When using a soldering iron finish all work as quickly as possible.
- When installing switches and knobs be careful not to install them in the wrong place or upside-down. See Fig. 1.

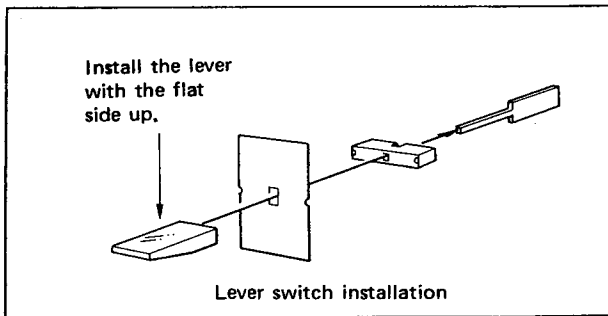

Fig. 1

CABINET REMOVAL

- a. Remove screws 1~4 as shown in Photo 1.
- b. Remove the cabinet as shown in Photo 2.

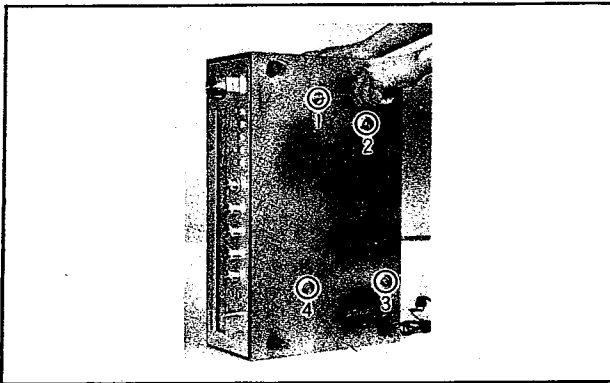

Photo 1

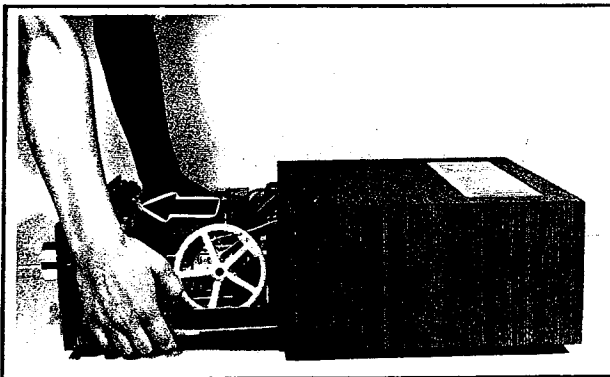

Photo 2

FRONT PANEL REMOVAL

- a. Remove the Function, Speaker and Tuning knobs using the hexagonal wrench provided.
- b. Pull off the Mic. Vol., Bass Treble, Loudness and Volume/Balance knobs.
- c. Remove screws 1~6 as shown in Photo 3, then remove the front panel by pulling it forward.

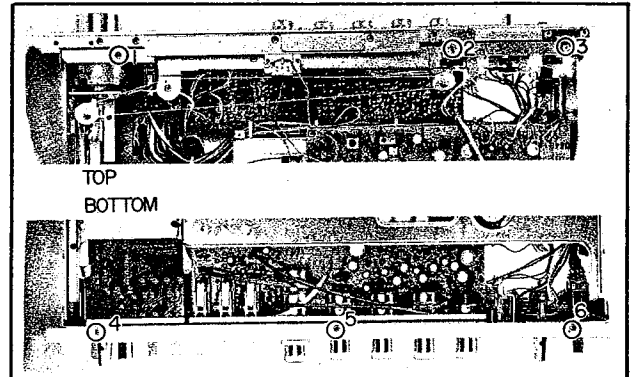

Photo 3

DROPPING THE SUB CHASSIS UNIT

- a. Pull out the rear panel connector as shown in Photo 4.

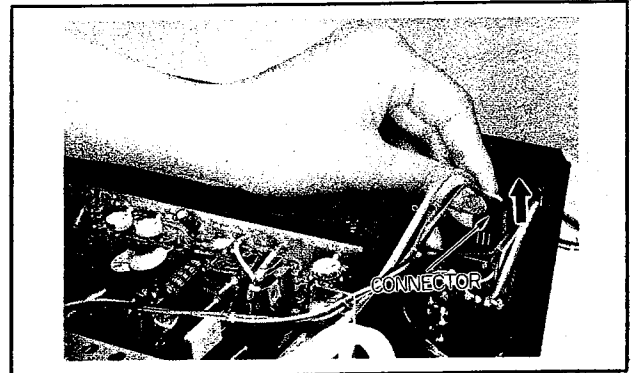

Photo 4

- b. Remove red-headed screws 1, 2 and loosen screws 3 as shown in Photo 5.

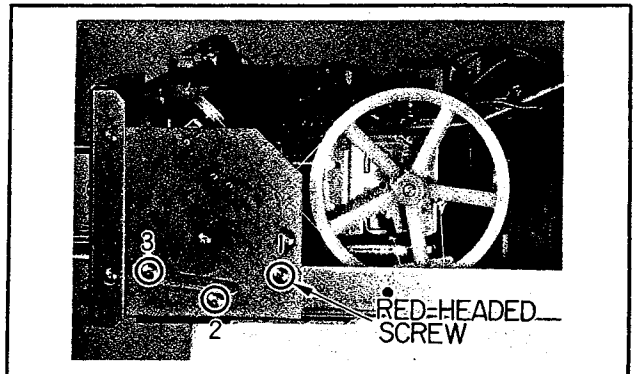

Photo 5

- c. Pull the sub chassis unit forward and drop it as shown in Photo 6.

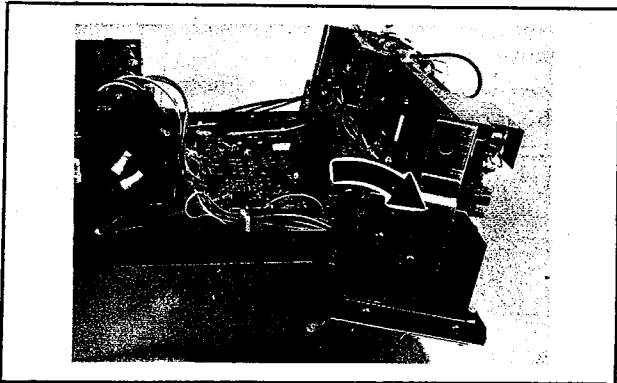

Photo 6

DROPPING THE REAR PANEL

- a. Pull out the connector (refer to Photo 4).
b. Remove screws 1, 2 as shown in Photo 7.

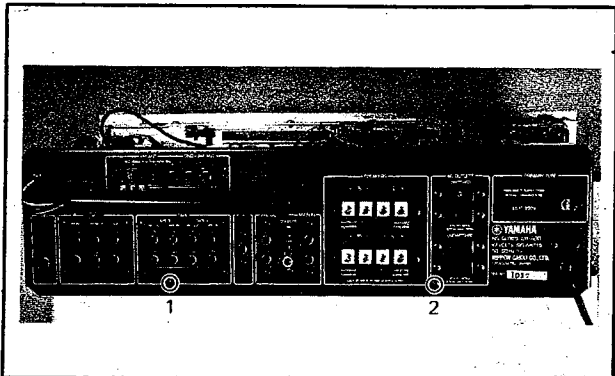

Photo 7

- c. Remove screw 1 and loosen screws (red-headed screw) as shown in Photo 8, then bring the rear panel down as shown in Photo 9.

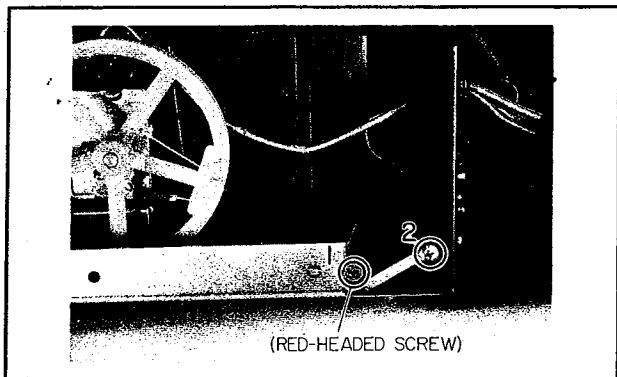

Photo 6

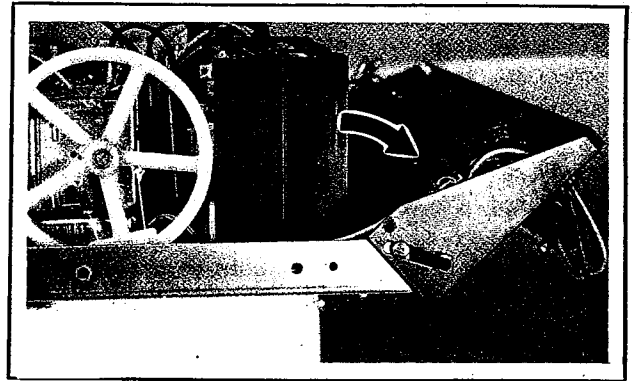

Photo 9

PRE AMP CIRCUIT BOARD REMOVAL

- a. Remove the front panel (refer to Photo 3).
b. Pull off the switch knobs, switch aprons and bushings (LOW FILTER, HIGH FILTER & MODE).
c. Remove screws 1~4 as shown in Photo 10.

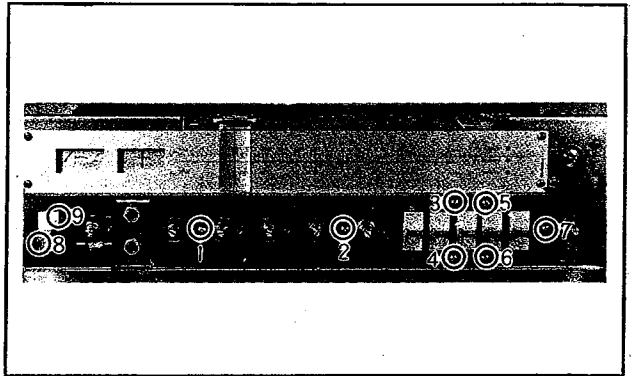

Photo 10

- d. Remove the lead cord connected to the Mic jack with a soldering iron as shown in Photo 11.
e. Tilt the sub chassis down forward (refer to Photo 6).
f. Remove the pre amp circuit board by pulling it up.

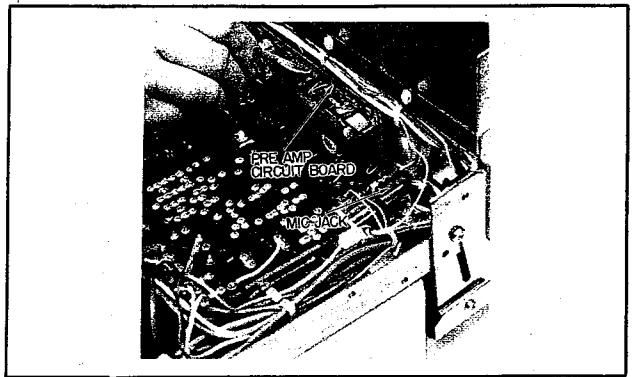

Photo 11

FUNCTION CIRCUIT BOARD REMOVAL

- Remove the front panel (refer to Photo 3).
- Pull off the switch knobs, switch aprons and bushings (TAPE A & TAPE B).
- Remove screws 5~7 as shown in Photo 10.
- Tilt the sub chassis down forward (refer to Photo 6).
- Remove the function circuit board by lifting it up.

TUNING AND SIGNAL METER REMOVAL

- Tilt the sub chassis unit down forward (refer to Photo 6).
- Pull off the three lead-type lamps with their shade bushings.
- Remove the meter holder spring in Photo 12 as shown in Photo 13, then remove the meter.

POWER SWITCH REMOVAL

- Remove the front panel (refer to Photo 3).
- Pull off the switch knobs, switch aprons and bushings (POWER).
- Remove screws 8, 9 as shown in Photo 10.

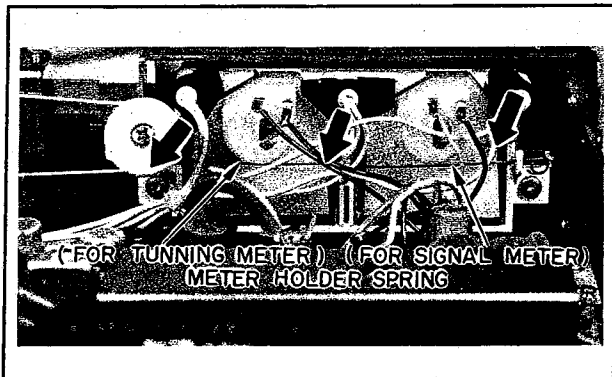

Photo 12

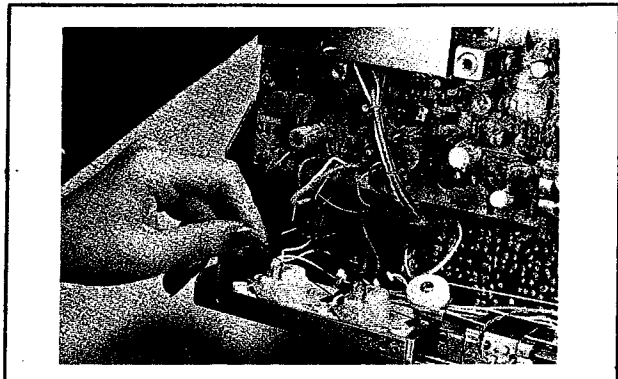

Photo 13

POWER CIRCUIT BOARD REMOVAL

- Tilt the sub chassis down forward (refer to Photo 6).
- Hold the three circuit board holders shown in Photo 14 with a long-nosed pliers as shown on Photo 15. Pull the power circuit board up and pull it out from the sheet holder.

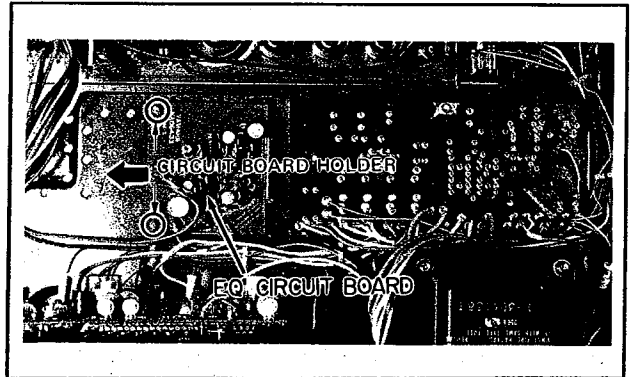

Photo 14

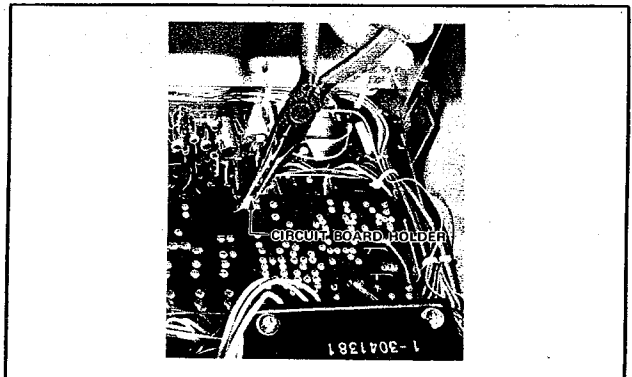

Photo 15

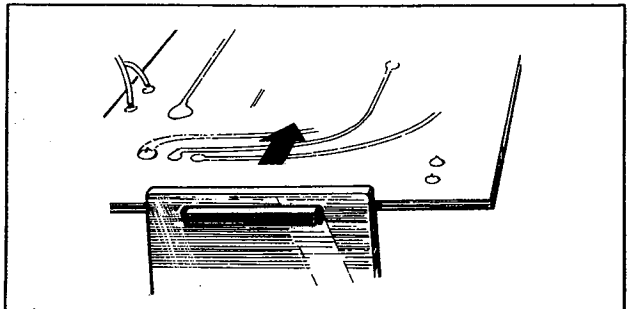

Fig. 2

Note: If you pull only the one sheet holder, this will apply excessive force to the board/chassis joint (see Fig. 2). This will probably crack the board. Be careful to hold the board and pull off the circuit board holder little by little.

- Slide the circuit board in the direction of the arrow to remove it.

EQ CIRCUIT BOARD REMOVAL

- Tilt the sub chassis down forward (refer to Photo 6).
- Hold the two sheet holders shown in Photo 16 with long-nosed pliers and pull the EQ circuit board up to remove it from the circuit board holder (refer to the Note to the right).
- Slide the EQ circuit board in the direction of the arrow to remove it.

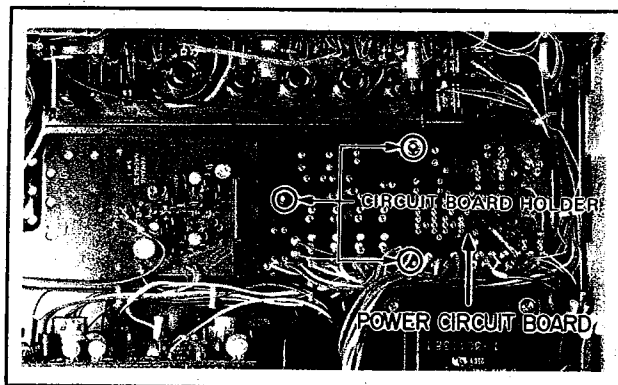

Photo 16

MAIN AMP CIRCUIT BOARD REMOVAL

- Remove screws 1, 2 as shown in Photo 17.
- Remove the main amp circuit board by pulling up.
- Bring the rear panel down for power transistor change or adjustment (refer to Photo 9).

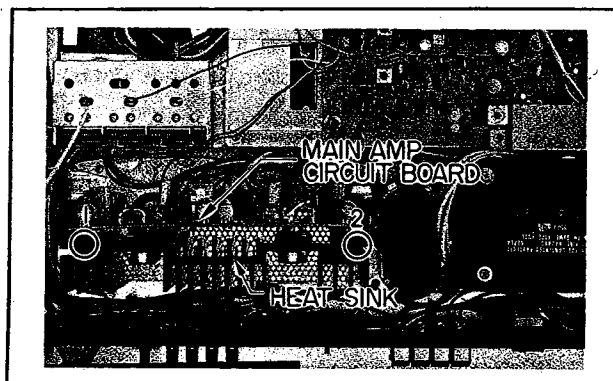

Photo 17

TUNER CIRCUIT BOARD REMOVAL

- Remove screws 1, 2 shown in Photo 18, and remove the FM shield cover.
- Pull out the pin jack shown in Photo 18.
- Remove screws 1~4 shown in Photo 18.
- Pull up the tuner circuit board to remove it.

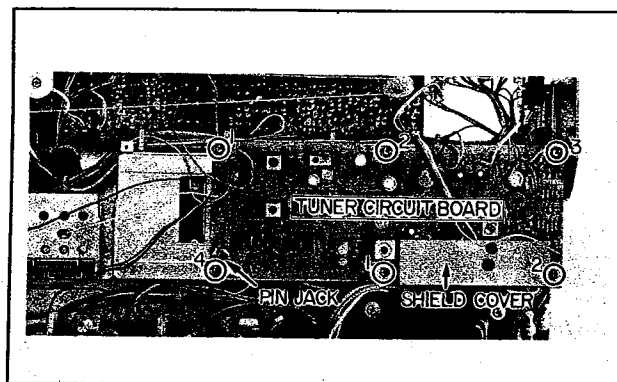
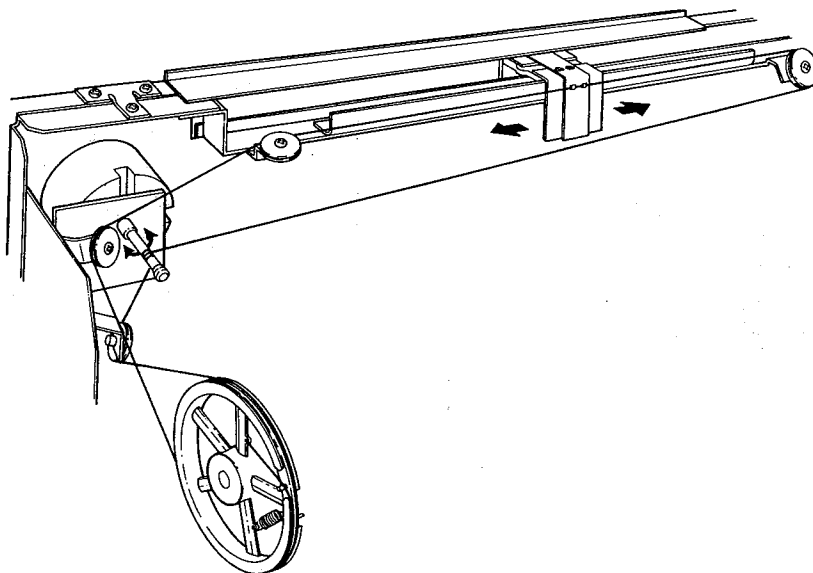

Photo 18

DIAL MECHANISM



MEASUREMENT AND ADJUSTMENT

TUNER CIRCUIT BOARD

FM IF ADJUSTMENT

STEP	ALIGNMENT ITEM	TERMINALS TO BE CONNECTED	INSTRUMENT REQUIRED	ADJUST	HOW TO ADJUST	RATING OR STANDARD	REMARKS
1	S-Curve	Input connector IO-E terminal Refer to Fig. 1	Sweep Generator OUTPUT 40dB/400±100Ω Oscilloscope Refer to Fig. 1.	T101 discrim coil (top and bottom) core, primary and secondary side	Adjust for sym- metrical S curve with the sec- ondary-side (up- per) core. Adjust for max. height with the primary-side (lower) core. Refer to Figs 2,3.	Output voltage: More than 400mVp-p Intermediate frequency: within 10.7MHz ±200kHz Bandwidth: More than 300kHz	

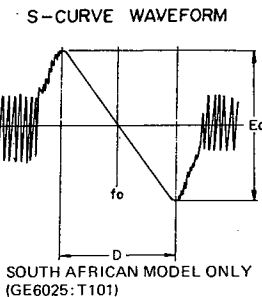
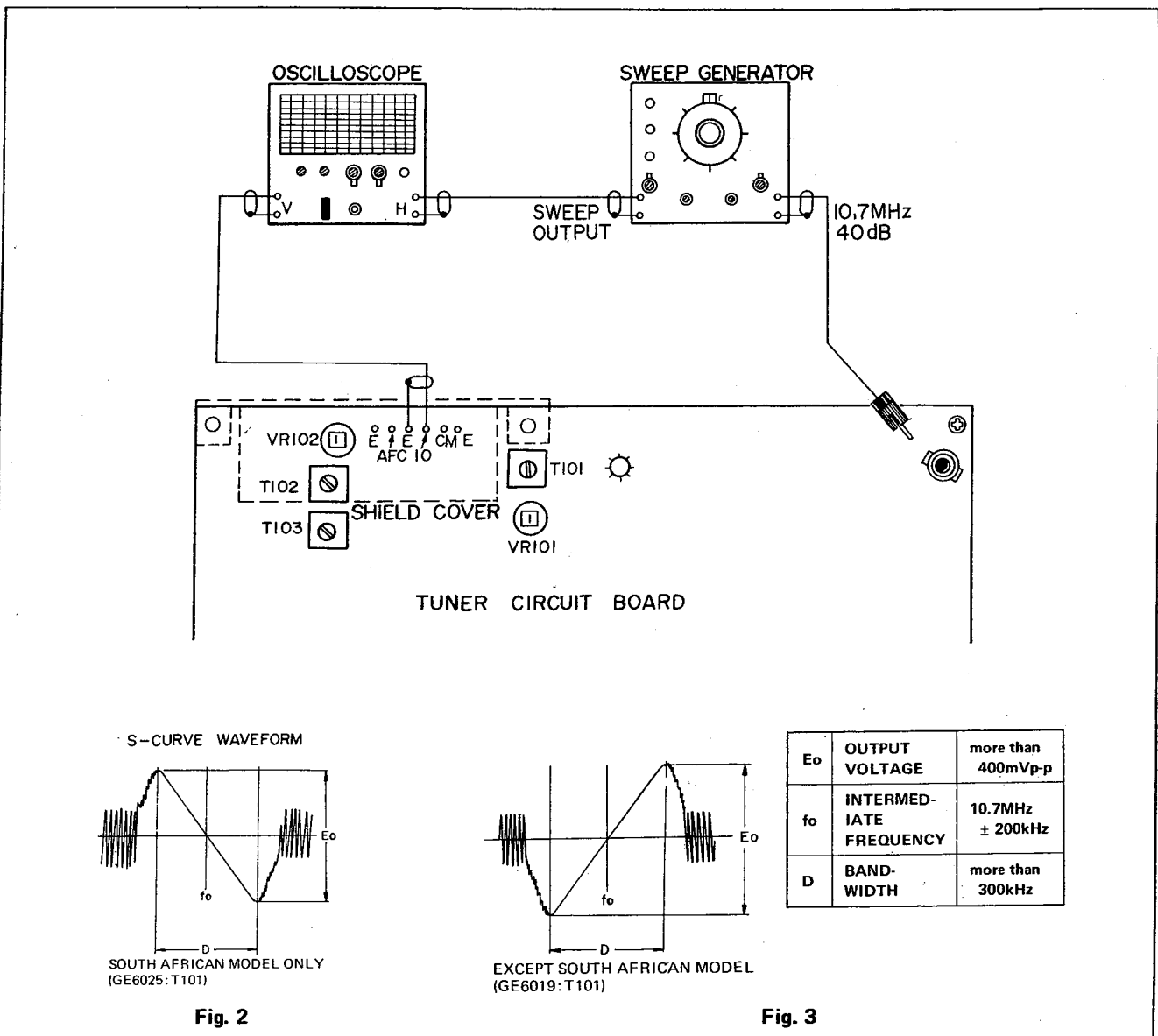

Fig. 2

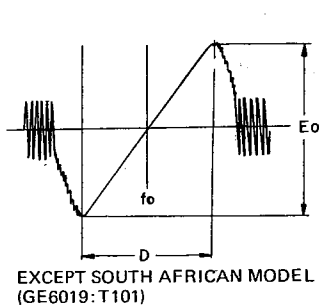

Fig. 3

Eo	OUTPUT VOLTAGE	more than 400mVp-p
fo	INTERMEDIATE FREQUENCY	10.7MHz ± 200kHz
D	BANDWIDTH	more than 300kHz

FM MPX ADJUSTMENT

STEP	ALIGNMENT ITEM	TERMINALS TO BE CONNECTED	INSTRUMENT REQUIRED	ADJUST	HOW TO ADJUST	RATING OR STANDARD	REMARKS
1	Pilot signal	FM ANT terminal (300Ω) TP1 (LA3311 NO. 14 pin)	FM Signal Generator 98MHz/60dBμ Modulation :400Hz/100%stereo Oscilloscope Electronic Voltmeter	T102 (GE 6056) Refer to Fig. 4.	Set for minimum variation at maximum output power.	Should be approx. 2Vp-p by LA3311 No. 14 pin.	Should be set at tuning point of TUNER COMPLETE ADJUSTMENT "2".
2	Separation adjustment	FM antenna terminal REC OUT jack	FM Signal Generator 98MHz/60dBμ Modulation :400Hz 100% stereo Oscilloscope Electronic Voltmeter	VR102 (10kΩB)	Adjust VR102 for best L-R separation. Refer to Fig. 4. Note: When adjusting VR102 check the indication ratio of measuring device and turn gently.	Variation for both channels at the same time should be more than 26dB, one channel should be 30dB. The difference between L and R should be within 3dB.	Should be set at tuning point of TUNER COMPLETE ADJUSTMENT "2".

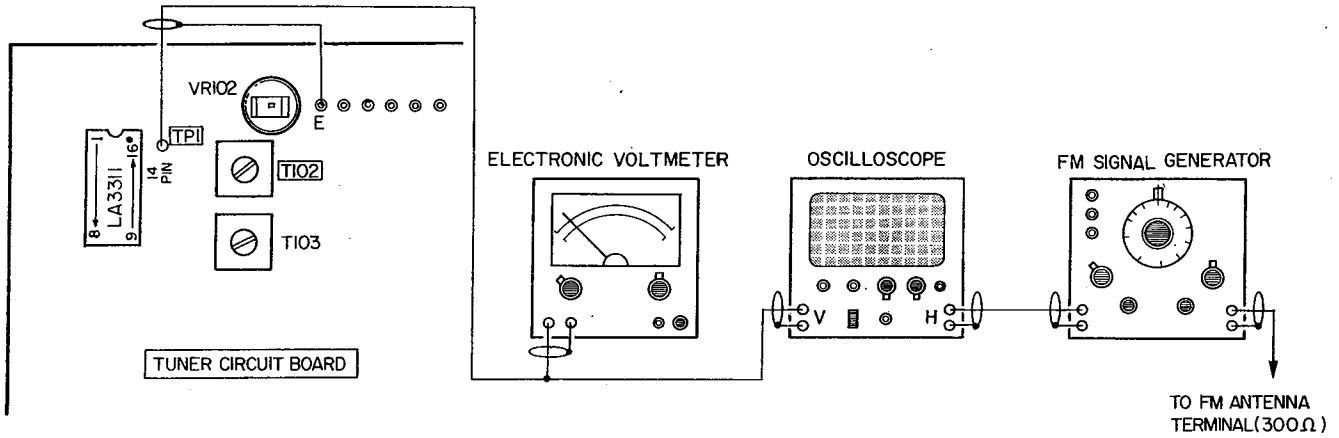

Fig. 4

FM TUNER COMPLETE ADJUSTMENT

STEP	ALIGNMENT ITEM	TERMINALS TO BE CONNECTED	INSTRUMENT REQUIRED	ADJUST	HOW TO ADJUST	RATING OR STANDARD	REMARKS
1	Discrim balance			T101 discrim coil secondary side (top)	Adjust for tuning meter position at 0 with Out of Tune noise.		Do not connect anything to the FM antenna terminal.
2	Tuning point set	FM ANT terminal	FM Signal Generator 98MHz/60dB μ Modulation :400Hz/100% mono	Tuning knob	Center the tuning meter by tuning		AFC OFF Ground the AFC terminal of the tuner circuit board Refer to Fig. 5.
3	Front-end IF tuning	FM ANT terminal (300 Ω)	FM Signal Generator 98MHz/60dB μ Modulation :400Hz/100% mono	Front-end IF core primary and secondary side.	Set for maximum signal meter deflection.		Should be set at tuning point 2.
4	Distortion adjustment (mono)	FM ANT terminal (300 Ω) REC OUT jack	FM Signal Generator 98MHz/60dB μ Modulation :400Hz/100% mono Oscilloscope Distortion ratio meter Electronic Voltmeter	T101 discrim coil primary side (lower) core	Adjust right and left little by little until achieving lowest distortion. Less than -50dB	Less than -50dB	Tuning point of 2.
5	Distortion ratio adjustment (stereo)	FM ANT terminal REC OUT jack	FM Signal Generator 98MHz/60dB μ Modulation :400Hz/100% stereo [L, R : L-R] Oscilloscope Distortion ratio meter Electronic Voltmeter	Refer to Fig. 6 T103 (GE 6069) front end IF (Upper and lower) core. Refer to Fig. 6.	Adjust T103 for minimum distortion at maximum L-R signal. Adjust front end IF (Upper and lower) core, via L or R for minimum distortion. Refer to Fig. 6.	Less than -38dB	Tuning point of 2.
6	Muting level adjustment	FM ANT terminal (300 Ω) REC OUT jack	FM Signal Generator 98MHz/20dB μ Modulation :400Hz/All the way to the left. Oscilloscope Electronic Voltmeter	VR101 (470B) Refer to Fig. 7.	Turn to the right little by little until output power appears.	Level where Output appears	Tuning point of 2.

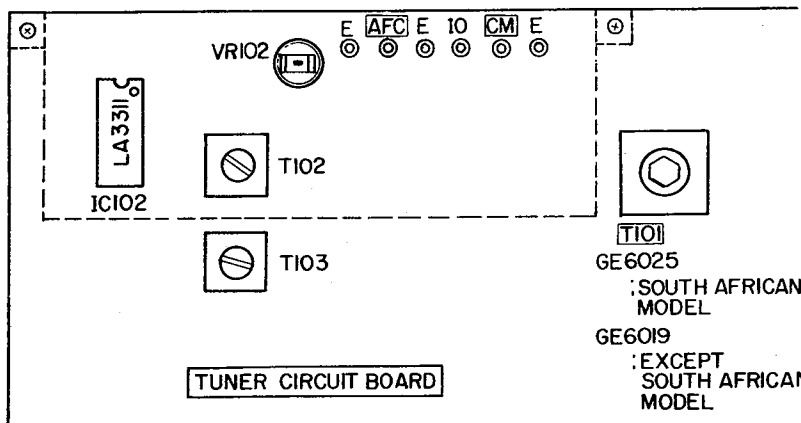

Fig. 5

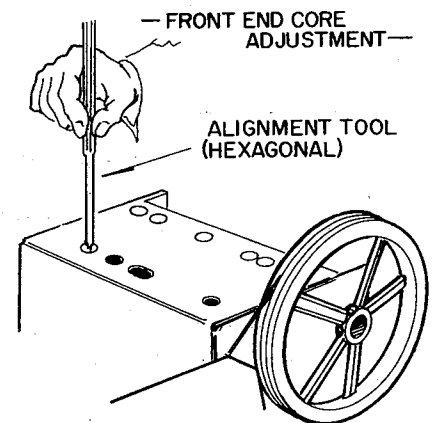
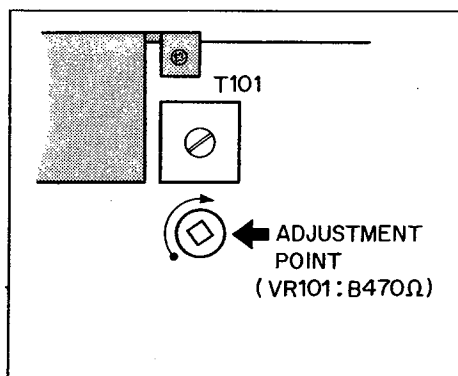

Fig. 6

FM TRACKING ADJUSTMENT

STEP	ALIGNMENT ITEM	TERMINALS TO BE CONNECTED	INSTRUMENT REQUIRED	ADJUST	HOW TO ADJUST	RATING OR STANDARD	REMARKS
1	Dial Pointer adjustment I Dial Pointer adjustment II	FM ANT terminal (300Ω)	FM signal Generator 98MHz/60dBμ	Tuning knob Dial Pointer	Turn the knob and set the tuning point at 3-2. Set to the middle of the "98" on the gauge board.		AFC-OFF Ground the AFC terminal of the tuner circuit board. Refer to Fig. 5.
2	LOW-RANGE tracking conformation	FM ANT terminal (300Ω)	FM Signal Generator 90MHz/60dBμ	Tuning knob	Turn the knob and set the tuning point at 1.	Within ±1.5-mm from the middle of the letter.	AFC-OFF Either 2 or 2' will be out of the standard slide indicator. Set to standard frequency using the one out of standard.
2'	HIGH-RANGE tracking conformation	FM ANT terminal (300Ω) AFC muting sheet CM-E	FM Signal Generator 106MHz/60dBμ	Dial Pointer	Check the displacement from the middle of the gauge board letter.		
3	Tracking adjustment I	FM ANT terminal (300Ω)	FM Signal Generator 90, 98, 106MHz/60dBμ	Tuning knob Dial Pointer	Reset the dial pointer so that the greatest deviation is within the standard range.		When both 2 and 2' are out of the standard range.
4	Tracking adjustment II	FM ANT terminal (300Ω)	FM Signal Generator 90, 98, 106MHz 90MHz/60dBμ 30dBμ 106MHz/60dBμ 30dBμ	Tuning knob Front End LOSC (LO) RF (LR1, LR2), ANT (LA) Core Front End LOSC (TCO) RF (TCR1, TCR2) ANT (TCA) Trimmer.	Set the Dial pointer at the letter. Set the tuning point at 1. Set for maximum signal meter deflection. Set the tuning point at 1. Set for maximum signal meter deflection.		Even when adjusted by methods 2, 2' and 3, results are still not within the standard range.



Note: When adjusting VR101 check the indication ratio of measuring device and turn gently.

Fig. 7

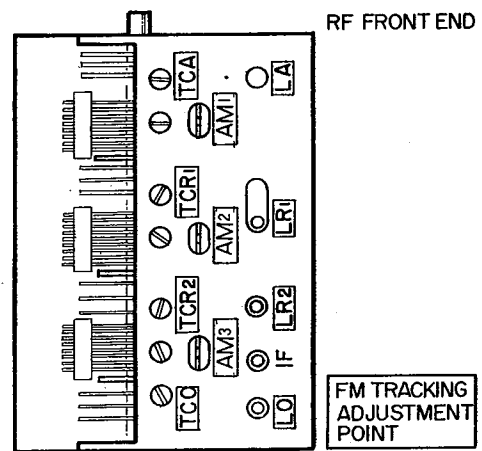

Fig. 8

AM IF ADJUSTMENT

STEP	ALIGNMENT ITEM	TERMINALS TO BE CONNECTED	INSTRUMENT REQUIRED	ADJUST	HOW TO ADJUST	RATING OR STANDARD	REMARKS
1	V- Curve	TP2-E terminal TP3-E terminal SM-E terminal	Sweep generator Oscilloscope Refer to Fig. 9.	CF105 T106	Adjust for a curve like that in Fig. 10.	Output voltage: More than 500mV Intermediate frequency: Within 455kHz ± 10kHz Bandwidth: More than 5kHz Note: Intermediate frequency in South Africa is 470kHz ± 10kHz)	

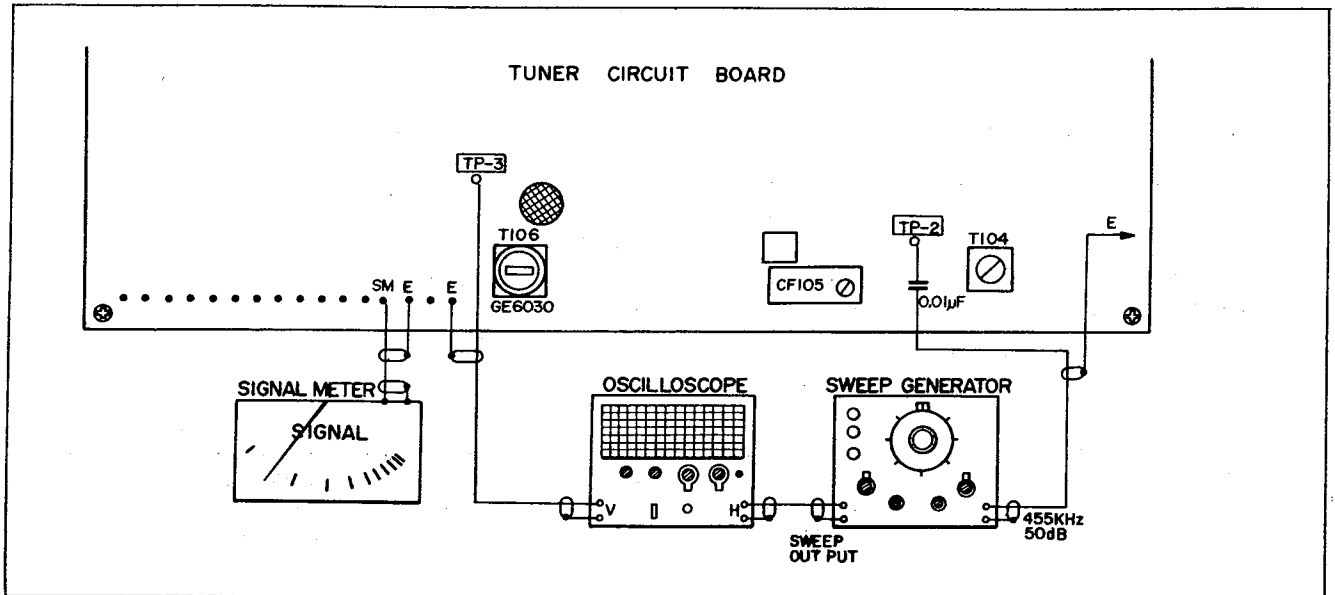

Fig. 9

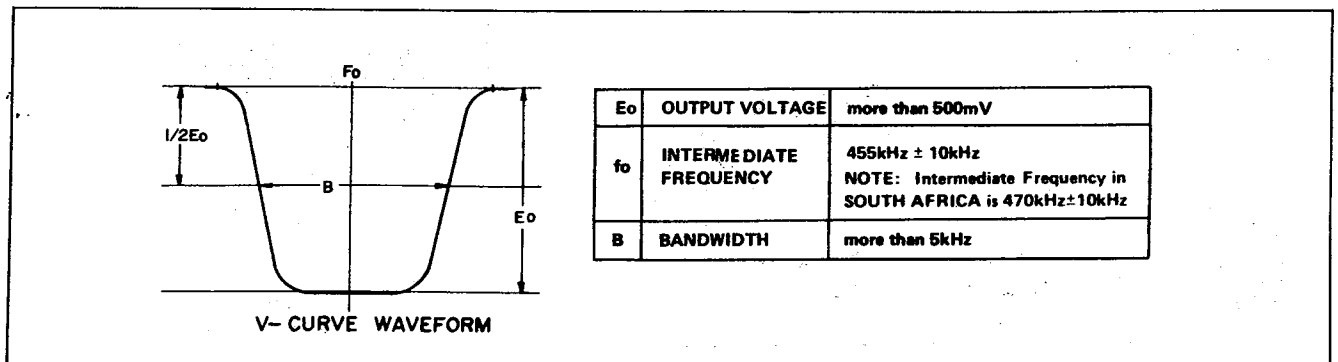

Fig. 10

AM TRACKING ADJUSTMENT

- Be sure to carry out this adjustment after FM adjustment

STEP	ALIGNMENT ITEM	TERMINALS TO BE CONNECTED	INSTRUMENT REQUIRED	ADJUST	HOW TO ADJUST	RATING OR STANDARD	REMARKS
1	OSC coil	Bar antenna REC OUT jack	AMSG (600kHz) Oscilloscope Electronic voltmeter	Tuning knob AM tuner circuit board I105 coil Refer to Fig. 11.	Set indicator at 600kHz. Set it to tune at 600kHz.		
2	LOW-RANGE sensitivity adjustment	Bar antenna REC OUT jack	AMSG (600kHz) Oscilloscope Electronic voltmeter	Bar antenna core and T104 coil Refer to Fig. 11.	Set for maximum sensitivity (according to the meter) at a tun- ing point of 600kHz.		
3	OSC trimmer adjustment	Bar antenna REC OUT ja	AMSG (1350- kHz) Oscilloscope Electronic voltmeter	Tuning knob Variable capacitor AM trimmer condenser Refer to Fig. 12 .	Set the indicator 1350kHz. Adjust at 1350kHz to tune.		Liner gauge
4	HIGH-RANGE sensitivity adjustment	Bar antenna REC OUT jack	AMSG (1350- kHz) Oscilloscope Electronic voltmeter	Variable capacitor AM1, AM2 Refer to Fig.12 .	Set for maximum sensitivity (by the meter) at 1350kHz tuning point.		
5	Sensitivity variation adjustment	Bar antenna REC OUT jack	AMSG (600- kHz ~ 1350kHz) Oscilloscope Electronic voltmeter	Repeat steps 1-4.	Set to both 600kHz and 1350kHz.		
6	Mid-range conforma- tion	Bar antenna REC OUT jack	AMSG (90kHz) Oscilloscope Electronic voltmeter	Tuning knob	Tune at maximum sensitivity (on the meter)	Within 1.5mm deviation from the 950kHz letter	Equation gauge 5.51

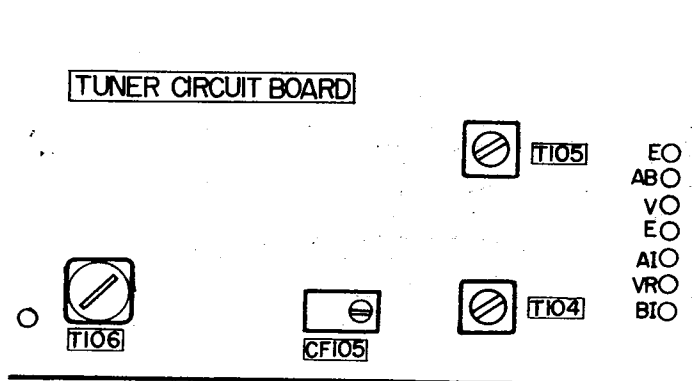

Fig. 11

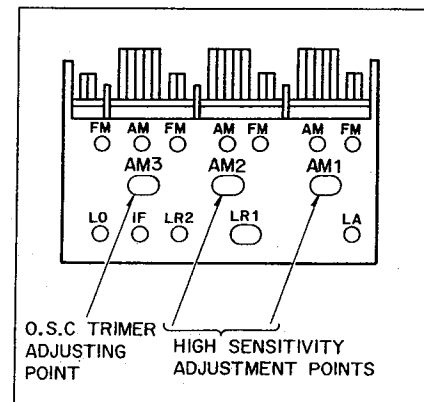

Fig. 12

MAIN AMP CIRCUIT

STEP	ALIGNMENT ITEM	TERMINALS TO BE CONNECTED	INSTRUMENT REQUIRED	ADJUST	HOW TO ADJUST	RATING OR STANDARD	REMARKS
1	Mid-point Voltage	TP3-TP5 TP4-TP6	Electronic Voltmeter	VR701 VR702	Set at standard ratio	$0 \pm 0.01V$	Refer to Fig.14
2	Idling current	TP1-TP3 TP2-TP4	Electronic Voltmeter	VR703 VR704	Set at standard ratio	$0.023 \pm 0.005V$	Refer to Fig. 14
3	Make sure by repeating steps 1 and 2 several times.						

Note: TP5 and TP6 ground terminals can be grounded to the main sheet input ground terminal during midpoint voltage adjustment.

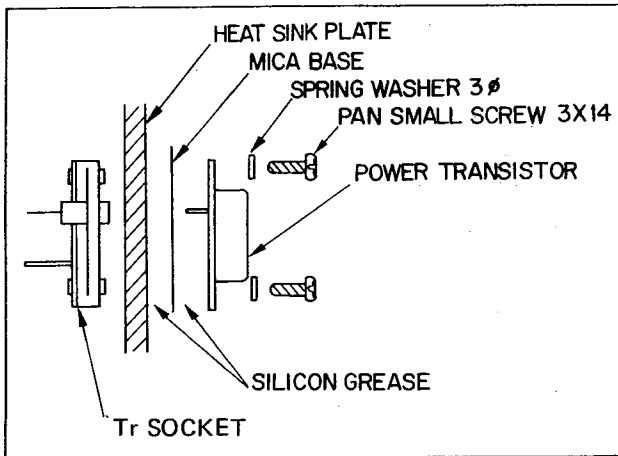

Fig. 13

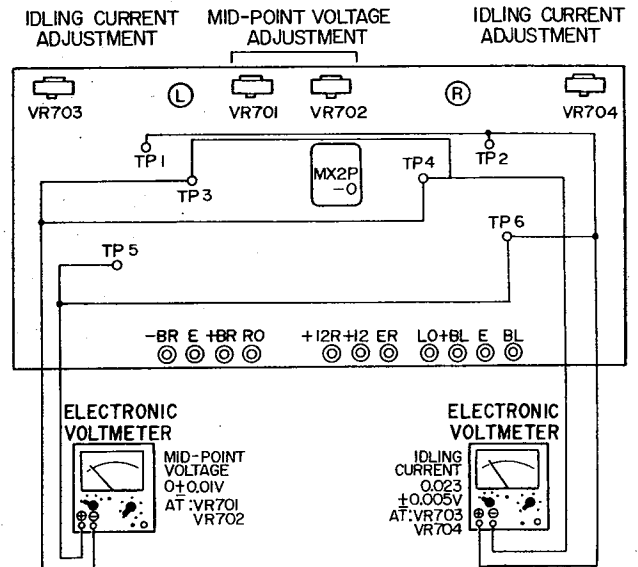

Fig. 14

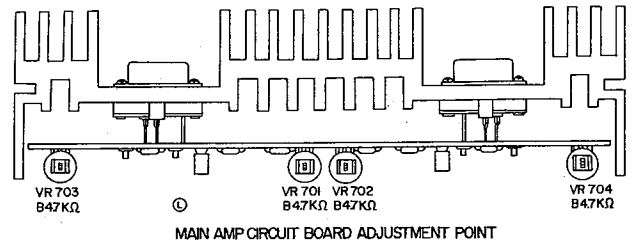

Fig. 15

PRINTED CIRCUIT BOARD

TUNER CIRCUIT BOARD

NA06431 U.S., Canadian Models
 NA06432 General, Australian, European Models
 NA06438 South African Model

- TO FUNCTION CIRCUIT BOARD #7 (9P CIS) (PK)
- TO RF FRONT END :AM3 (WH)
- TO 6P PIN JACK CIRCUIT BOARD #5 (4P CIS) (BL)
- TO 6P PIN JACK CIRCUIT #4 (4P CIS) (RE)
- TO RF FRONT END :AM2 (GR)
- TO 6P PIN JACK CIRCUIT (GR)

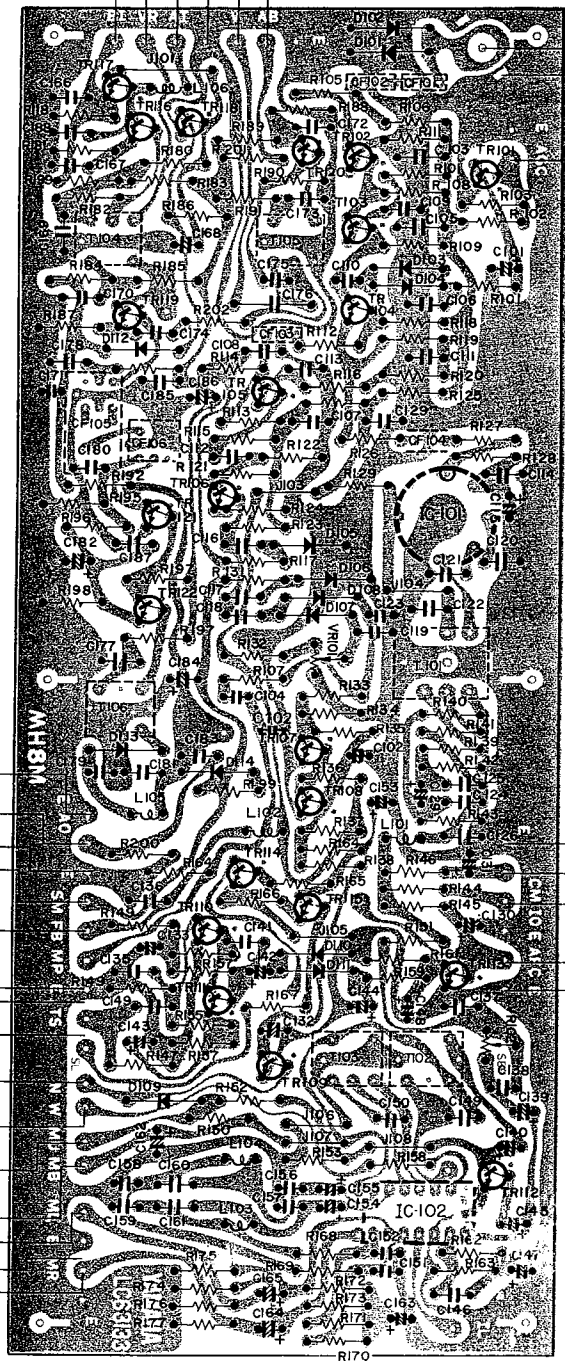

- (COAXIAL CABLE :BL) TO RF FRONT END #2, #3 (OUT)
- (VI) TO RF FRONT END #8 (AGC)

- TO FUNCTION CIRCUIT BOARD #4 (9P CIS) (RE)
- TO FUNCTION CIRCUIT BOARD #20 (20P CIS) (BL)
- TO SIGNAL METER (PK)
- TO FUNCTION CIRCUIT BOARD #8 (9P CIS) (OR)
- TO TUNING BEARING LUG (WH)
- TO LED CIRCUIT BOARD :SL (RE)
- TO PRE AMP CIRCUIT BOARD :N (GR)
- TO PRE AMP CIRCUIT BOARD :EM (GY)
- TO FUNCTION CIRCUIT BOARD #5 (9P CIS) (GR)
- TO POWER CIRCUIT BOARD :+12M (BR)
- TO FUNCTION CIRCUIT BOARD #17~#19 (20P CIS) (YE)

- (BL) TO TUNING METER
- (BE) TO TUNING METER
- (VI) TO COUPLER CIRCUIT BOARD
- (WH) TO RF FRONT END #1 (AFC)
- (BL) TO POWER CIRCUIT BOARD :E

WIRE COLOR ABBREVIATIONS

- BL ▶ Black
- BR ▶ Brown
- RE ▶ Red
- OR ▶ Orange
- YE ▶ Yellow
- GR ▶ Green
- BE ▶ Blue
- VI ▶ Violet
- GY ▶ Gray
- WH ▶ White
- GG ▶ Light Green
- SB ▶ Light Blue
- PK ▶ Pink

EQ AMP CIRCUIT BOARD NA06433

8P PIN JACK CIRCUIT BOARD NA06417

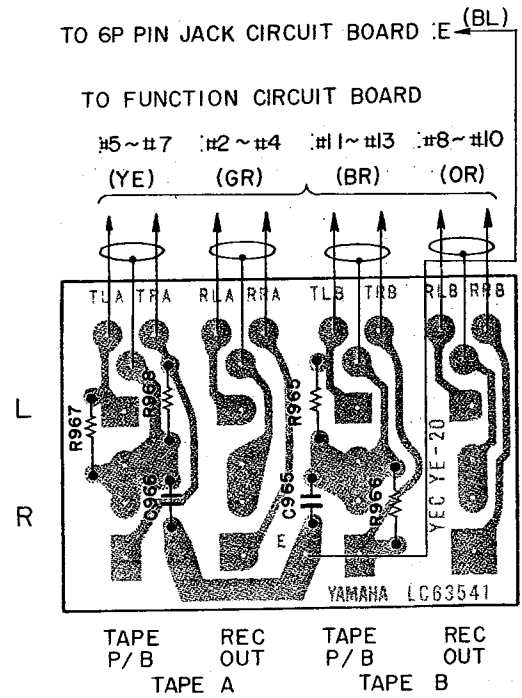
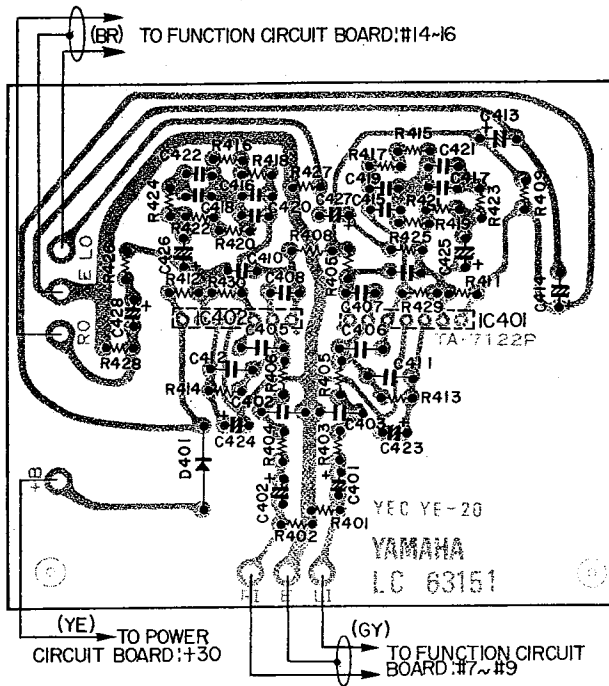

PRE AMP CIRCUIT BOARD NA06434

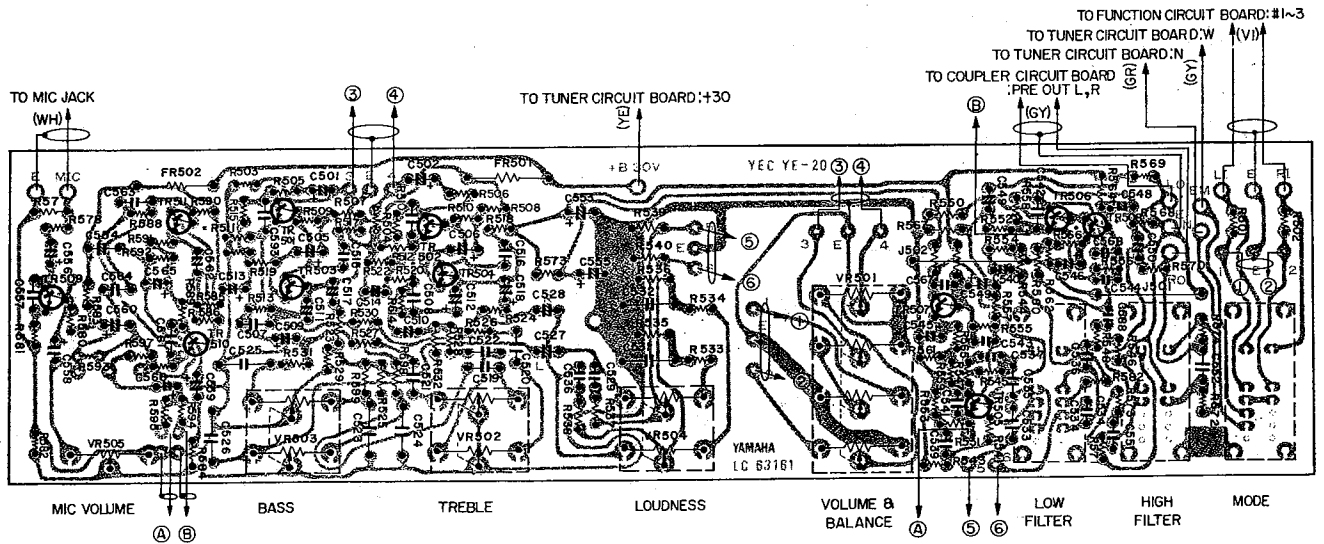

6P PIN JACK CIRCUIT BOARD NA06416

COUPLER CIRCUIT BOARD NA06414

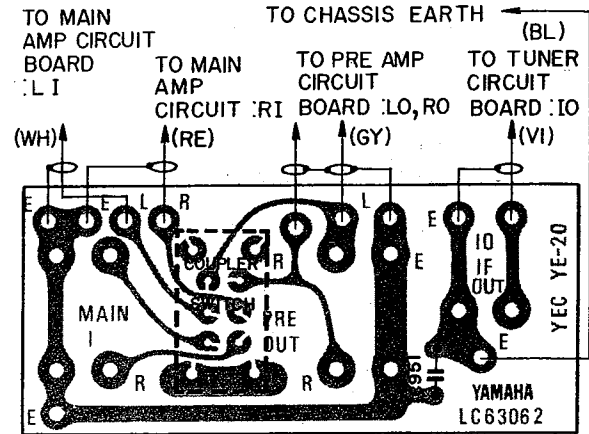
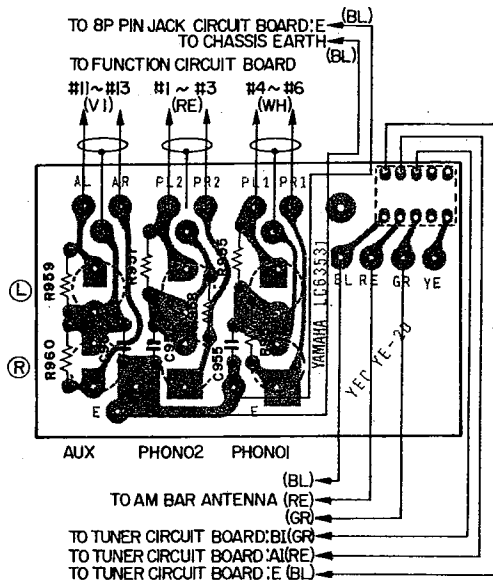

MAIN AMP CIRCUIT BOARD NA06427

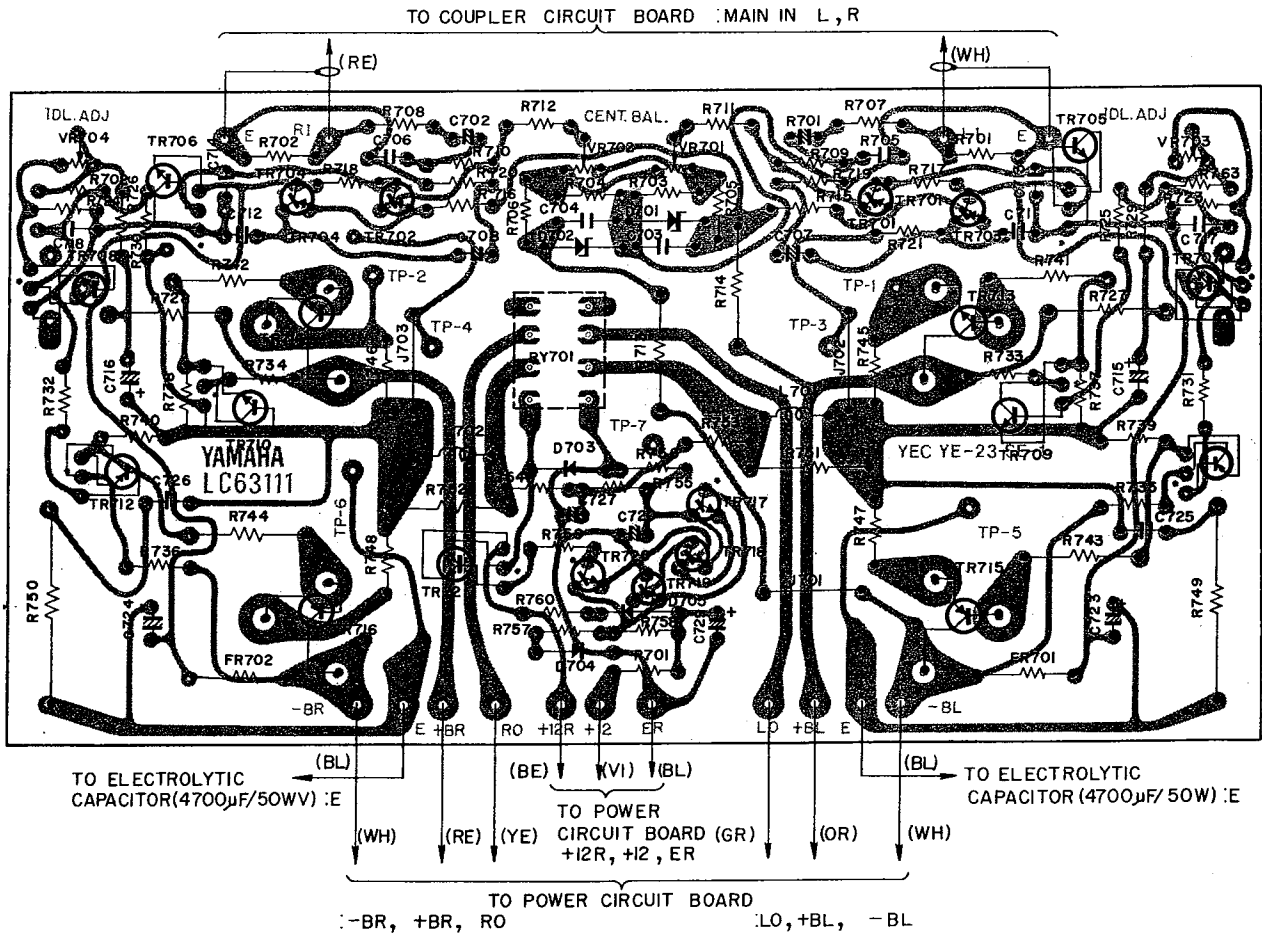

POWER CIRCUIT BOARD

NA06428

General, U.S., Canadian, Southe African,
Australian Models

NA06429

European Model

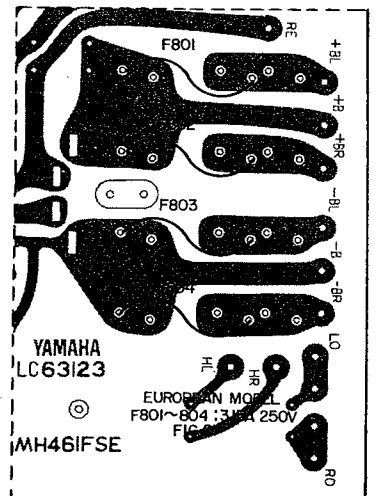
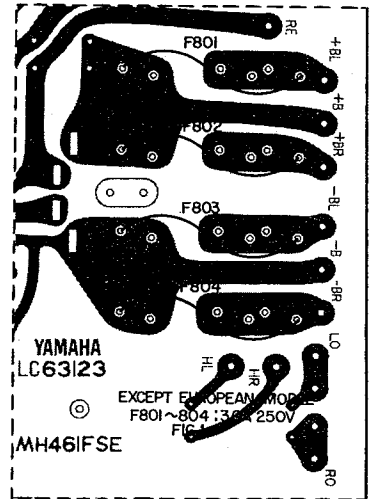
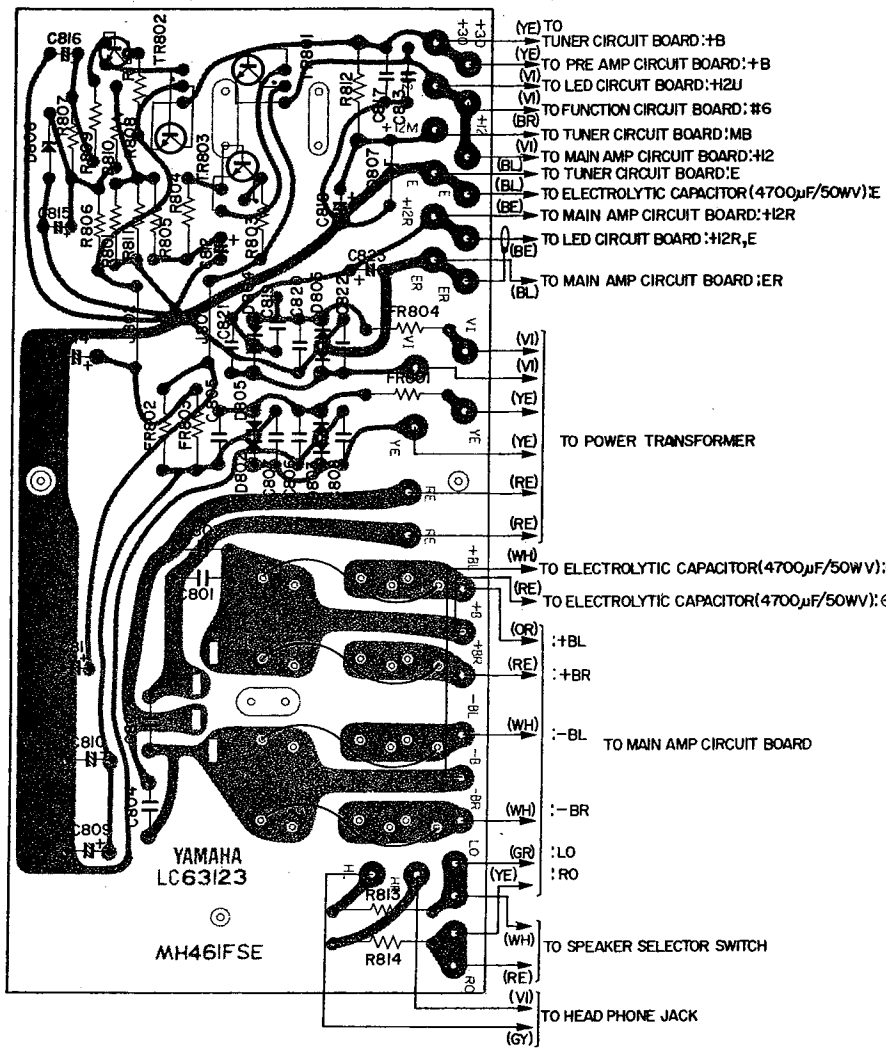

LIGHT EMITTING DIODE CIRCUIT BOARD

NA06409

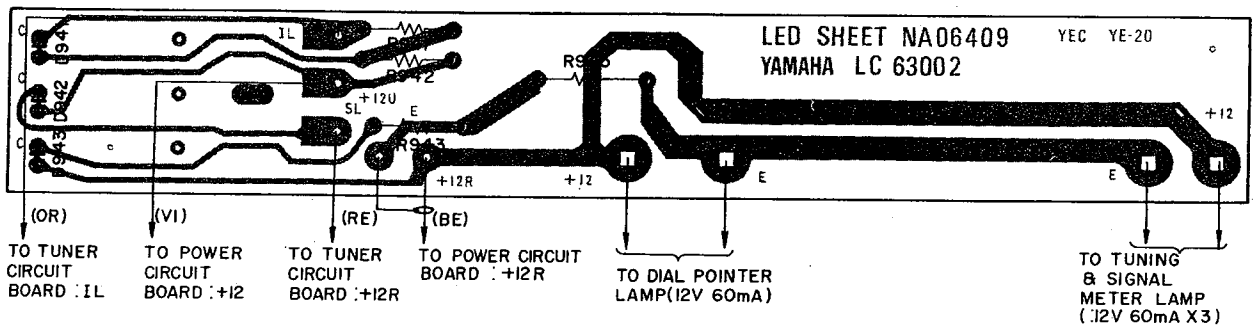

FUNCTION CIRCUIT BOARD NA06435

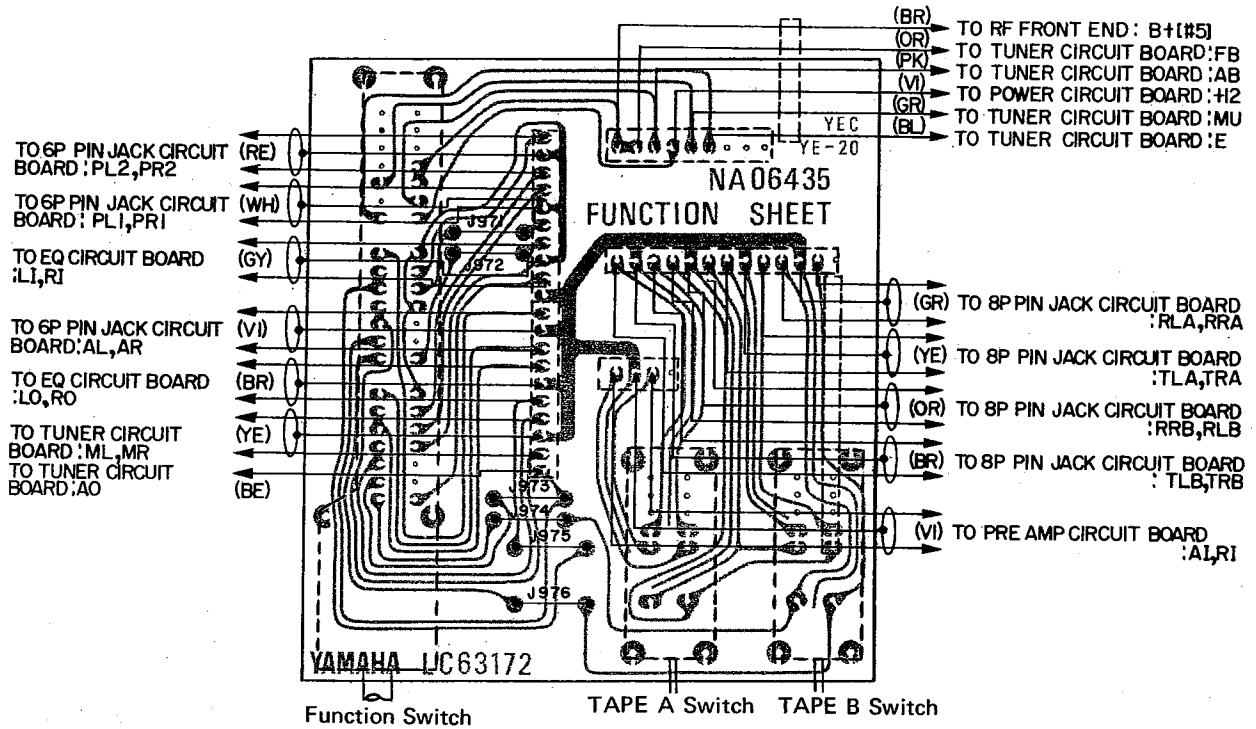

DIN CONNECTOR CIRCUIT BOARD (EUROPEAN MODEL ONLY) NA06415

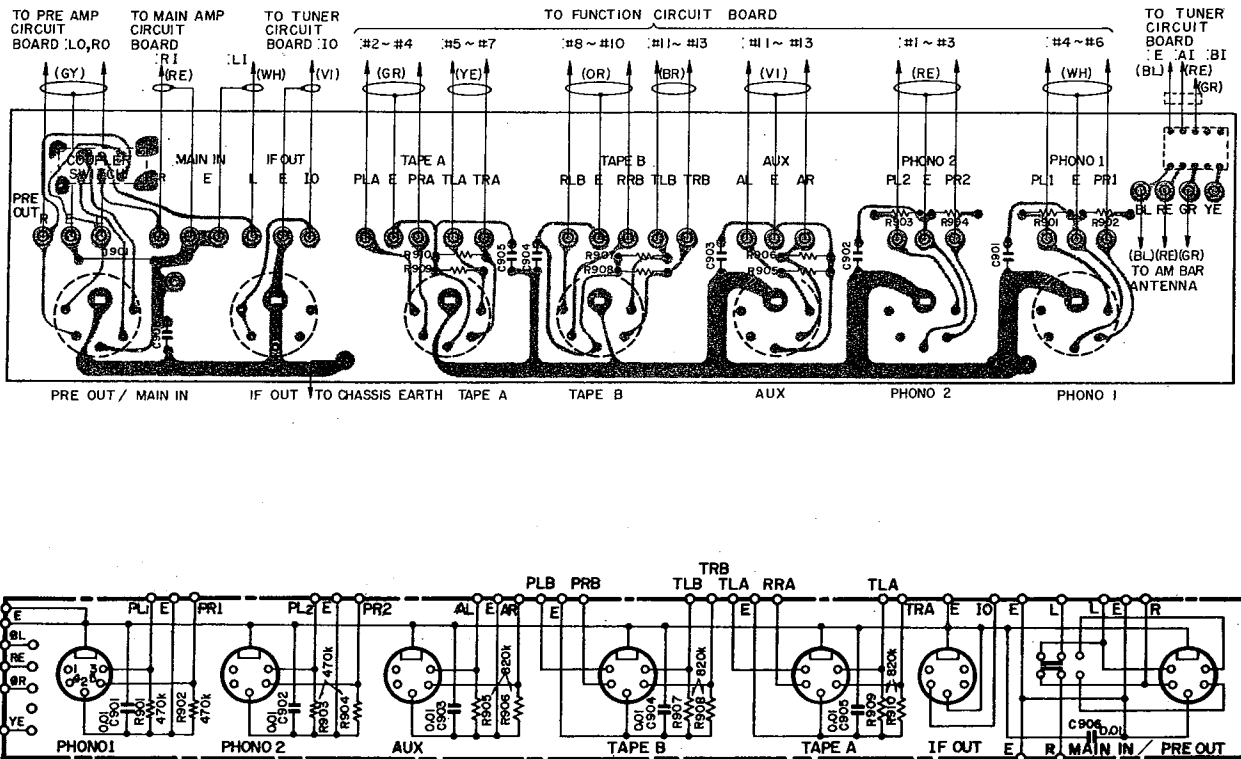

FRONTAL SCHEMATIC DIAGRAM

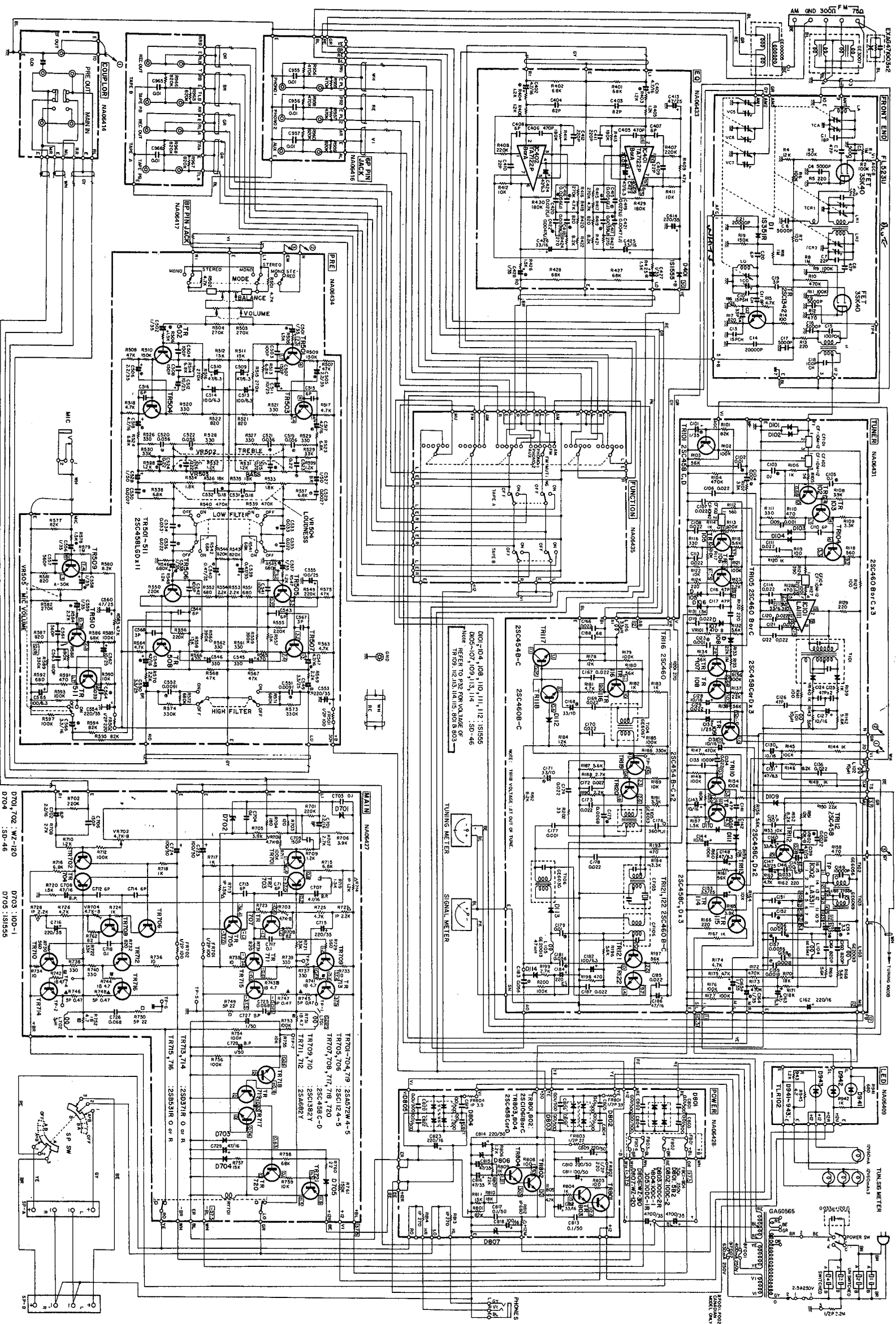

NOTE: REFER TO PARTS FOR VOLTAGE OF TUBES
 TR805, TR705, TR706, TR707, TR708, TR709, TR710, TR711, TR712, TR713, TR714, TR715, TR716, TR717, TR718, TR719, TR720, TR721, TR722, TR723, TR724, TR725, TR726, TR727, TR728, TR729, TR730, TR731, TR732, TR733, TR734, TR735, TR736, TR737, TR738, TR739, TR740, TR741, TR742, TR743, TR744, TR745, TR746, TR747, TR748, TR749, TR750, TR751, TR752, TR753, TR754, TR755, TR756, TR757, TR758, TR759, TR760, TR761, TR762, TR763, TR764, TR765, TR766, TR767, TR768, TR769, TR770, TR771, TR772, TR773, TR774, TR775, TR776, TR777, TR778, TR779, TR780, TR781, TR782, TR783, TR784, TR785, TR786, TR787, TR788, TR789, TR790, TR791, TR792, TR793, TR794, TR795, TR796, TR797, TR798, TR799, TR800, TR801, TR802, TR803, TR804, TR805, TR806, TR807, TR808, TR809, TR810, TR811, TR812, TR813, TR814, TR815, TR816, TR817, TR818, TR819, TR820, TR821, TR822, TR823, TR824, TR825, TR826, TR827, TR828, TR829, TR830, TR831, TR832, TR833, TR834, TR835, TR836, TR837, TR838, TR839, TR840, TR841, TR842, TR843, TR844, TR845, TR846, TR847, TR848, TR849, TR850, TR851, TR852, TR853, TR854, TR855, TR856, TR857, TR858, TR859, TR860, TR861, TR862, TR863, TR864, TR865, TR866, TR867, TR868, TR869, TR870, TR871, TR872, TR873, TR874, TR875, TR876, TR877, TR878, TR879, TR880, TR881, TR882, TR883, TR884, TR885, TR886, TR887, TR888, TR889, TR890, TR891, TR892, TR893, TR894, TR895, TR896, TR897, TR898, TR899, TR900, TR901, TR902, TR903, TR904, TR905, TR906, TR907, TR908, TR909, TR910, TR911, TR912, TR913, TR914, TR915, TR916, TR917, TR918, TR919, TR920, TR921, TR922, TR923, TR924, TR925, TR926, TR927, TR928, TR929, TR930, TR931, TR932, TR933, TR934, TR935, TR936, TR937, TR938, TR939, TR940, TR941, TR942, TR943, TR944, TR945, TR946, TR947, TR948, TR949, TR950, TR951, TR952, TR953, TR954, TR955, TR956, TR957, TR958, TR959, TR960, TR961, TR962, TR963, TR964, TR965, TR966, TR967, TR968, TR969, TR970, TR971, TR972, TR973, TR974, TR975, TR976, TR977, TR978, TR979, TR980, TR981, TR982, TR983, TR984, TR985, TR986, TR987, TR988, TR989, TR990, TR991, TR992, TR993, TR994, TR995, TR996, TR997, TR998, TR999, TR1000

CAPACITOR	
SYMBOL	PART NAME
○	TANTALUM CAPACITOR
⊗	BRIDGEMAN ELECTROLYTIC CAPACITOR
⊙	MYLAR CAPACITOR
○	POLYSTYRENE CAPACITOR
○	CERAMIC CAPACITOR
RESISTOR	
SYMBOL	PART NAME
○-W-○	FUSE RESISTOR
△	METAL OXIDE RESISTOR
▲	METAL PLATE RESISTOR
□	CEMENT MOLDED RESISTOR
⊠	FIRE PROOFING RESISTOR
NO MARK	CARBON RESISTOR

BLOCK DIAGRAM

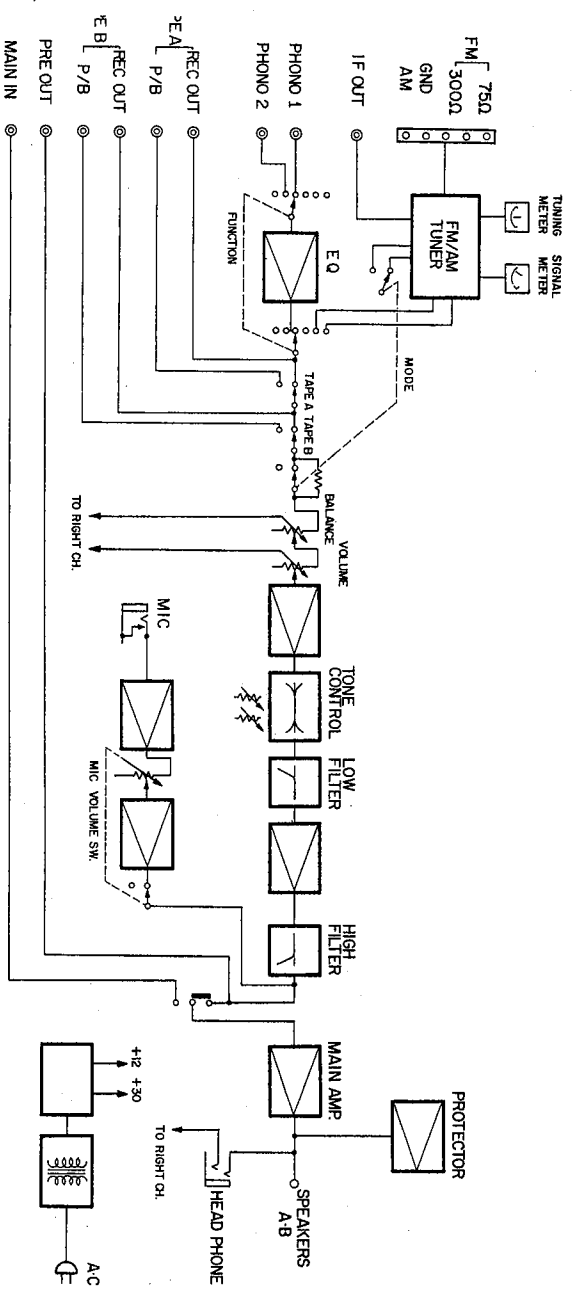

LTAGE TABLE of T-109, 112, 113, 114, 115, 801, 803.

TR 109	0	0.02	3.7	AT FM MUTING
TR 112	0	0.65	0	AT FM MUTING
TR 801	44	27	41	COLLECTOR VOLT.
TR 803	44	27	41	COLLECTOR VOLT.

TR113	TR114	TR115
B C	E B C	E B C
0 0.54	0 0.024	0 0.024
0 0.65	0 0.006	0 0.01

When tuning knob is reached.

When tuning knob is touched.

PARTIAL CHANGES MADE ACCORDING TO DESTINATION

POWER

• U.S. & CANADIAN MODELS

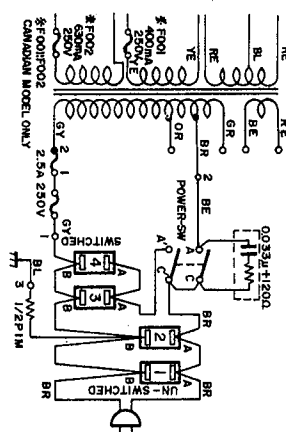

• GENERAL MODEL

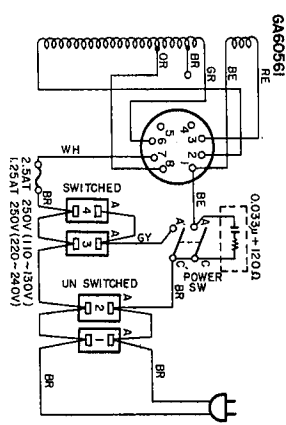

• AUSTRALIAN MODEL

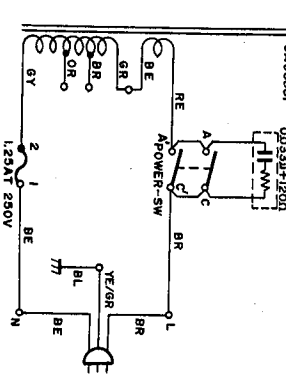

• SOUTH AFRICAN MODEL

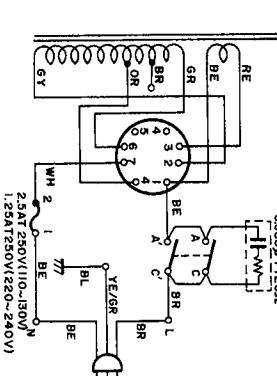

• EUROPEAN MODEL

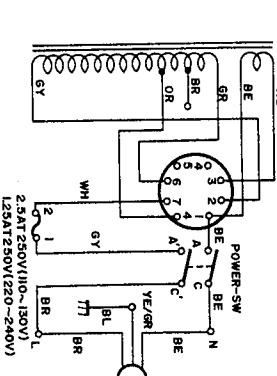

ANTENNA

• U.S. & CANADIAN MODELS

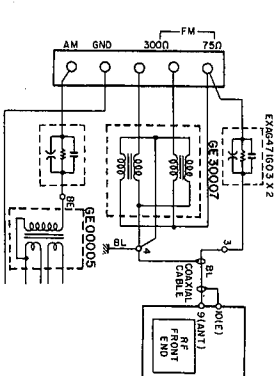

• EUROPEAN MODEL

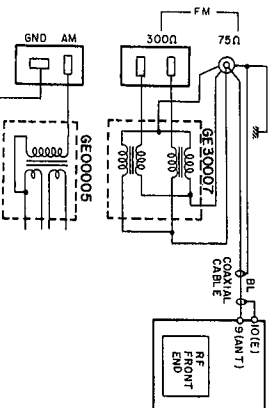

• EXCEPT U.S. & CANADIAN AND EUROPEAN MODELS

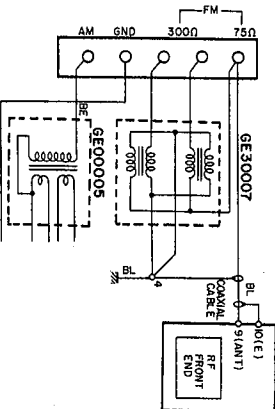

SPEAKER

• EUROPEAN MODEL

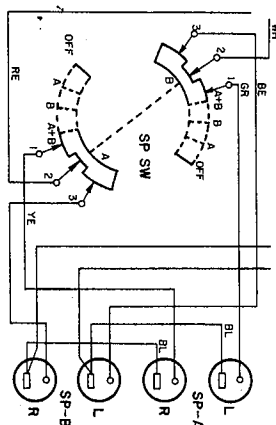

• EXCEPT EUROPEAN MODEL

Refer to OVERALL SCHEMATIC DIAGRAM

TUNER

PART NAME	FM IFT T101	MYLAR CAPACITOR C151	MYLAR CAPACITOR C152	AM CERAMIC FILTER CF105	AM CERAMIC FILTER CF106	RF FRONT END
DESTINATION						
SOUTH AFRICAN	GE 6025	0.0075µF	0.0075µF	FSN 1047	FSN 1048	FL-523S
U.S. & CANADIAN	GE 6019	0.01µF	0.011µF	FSN 1038	FSN 1036	FL-523U
GENERAL EUROPEAN & AUSTRALIAN	GE 6019	0.0075µF	0.0075µF	FSN 1038	FSN 1036	FL-523U

PARTS LIST

FRONT VIEW

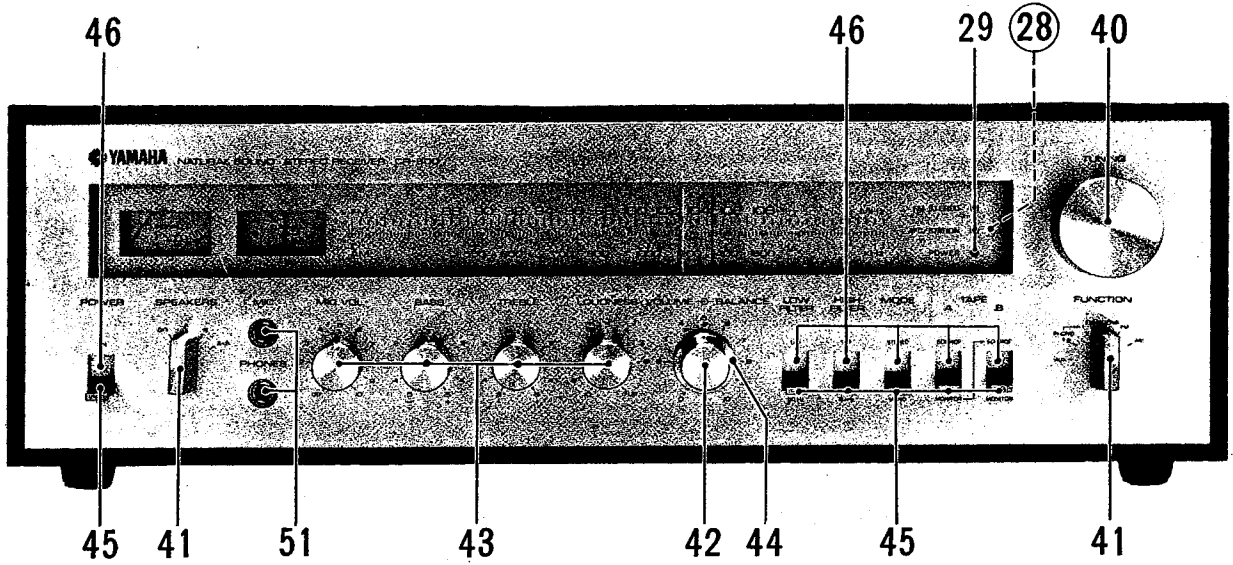

BACK VIEW

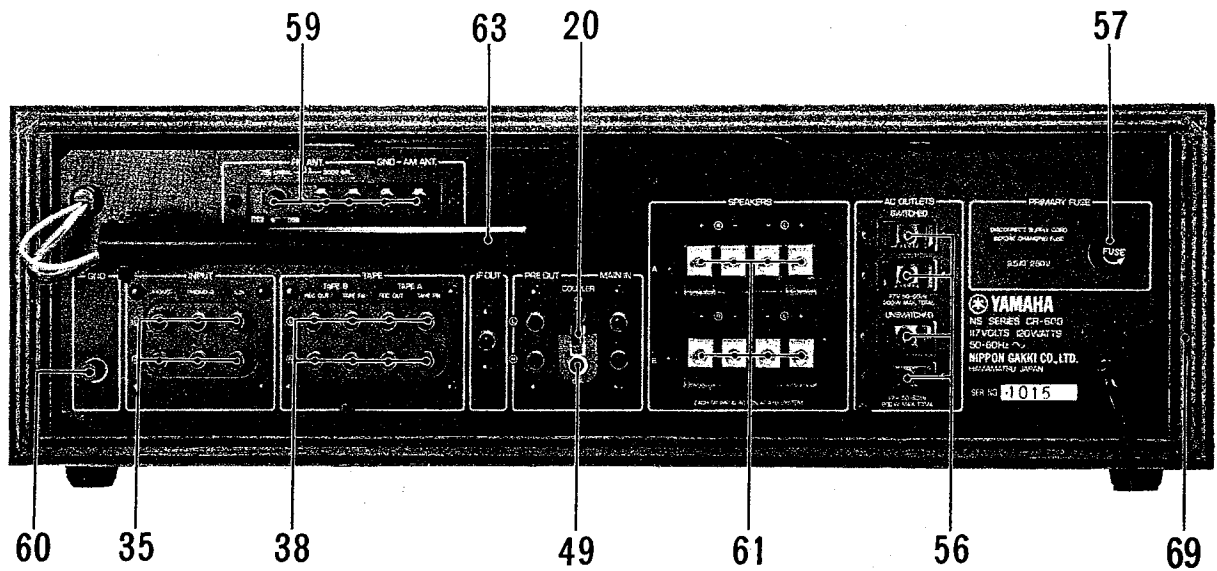

BACK VIEW (EUROPEAN MODEL)

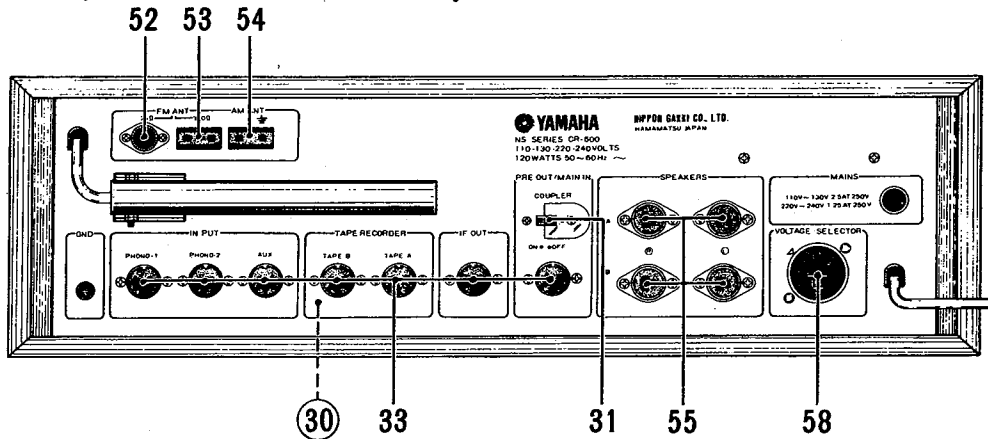

Ref. No.	Part No.	Description		Remarks	Common Models
	iC04608	Transistor	2SC460 (B or C)	トランジスタ	
3	LB10020	1 P Pin jack	SQ-3056	基板型ピンジャック	
④	NA06433	Equalizer Circuit board	#63151	イコライザースシート	
	FP13647	Tantalum capacitor	4.7 μ F 16 WV	タンタル固体コンデンサ	
	FP15610	- do. -	1 μ F 35 WV	"	
	iG00011	Integrated circuit	TA-7122P (B or A)	I C	
	iF00020	Diode	IS1555	ダイオード	
⑤	NA06435	Function Circuit board	# 63172	ファンクションシート	
6	KA20017	Lever switch	SLA-34251	レバースイッチ	
7	KA50035	Rotary switch	SRZ-066	ロータリースイッチ	
8	LB60035	CIS Connector socket	20 P	CISソケット	
9	LB60030	- do. -	13 P	"	
10	LB60025	- do. -	9 P	"	
11	LB40008	- do. -	4 P	"	
	LB10006	CIS Keying pin		CISキーイングピン	
⑫	NA06434	Pre-amp Circuit board	# 63161	プリシート	
	HZ00017	Fuse resistor	100 Ω 1/2W	ヒューズ抵抗	
	HZ00014	- do. -	220 Ω "	"	
	FM22633	Bipolar electrolytic capacitor (vert. type)	3.3 μ F 25WV	バイポーラ電解コンデンサ	
	FM11610	- do. - (vert. type)	1 μ F 50WV	"	
	FP13633	Tantalum capacitor	3.3 μ F 16 WV	タンタル固体コンデンサ	
	FP13647	- do. -	4.7 μ F "	"	
	FP15547	- do. -	0.47 μ F 35 WV	"	
	FP15610	- do. -	1 μ F "	"	
	FP15622	- do. -	2.2 μ F "	"	
	iC04585	Transistor	2SC458LG (D or C)	トランジスタ	

Ref. No.	Part No.	Description		Remarks	Common Models
13	HS12031	Variable resistor	HB 250K Ω , A 100K Ω	可変抵抗器	LEVEL CA-1000
14	HS12034	- do. - (with click)	B20K Ω x 2	"	LOUDNESS "
15	HS12035	- do. -	XZ25K Ω x 2	"	BASS CA-800
16	HS12036	- do. -	XZ10K Ω x 2	"	TREBLE "
17	HS12037	- do. - (with SW.)	A 50K Ω	"	MIC CR-800
18	KA20012	Lever switch	SLA34202	レバースイッチ	CA-1000
⑱	NA06414	Coupler Circuit board	# 63032	カブラーシート	except European Model
	FG14410	Ceramic capacitor	0.01 μ F	セラミックコンデンサ	
	LB20066	2 P Pin jack (PC)		2 Pピンジャック	
	LB10008	1 P " (")		1 Pピンジャック	
20	KA40021	Slide switch	SL222B4	スライドスイッチ	
⑳	NA06427	Main-amp Circuit board	# 63111	メインシート	
	HL41612	Metal oxide resistor	1.2 K Ω 1 W	酸化金属抵抗	
	HL41615	- do. -	1.5 K Ω "	"	
	HL41622	- do. -	2.2 K Ω "	"	
	HZ00027	Metal plate resistor	0.47 Ω 5 W	金属板抵抗	
	HM55422	Cement molded resistor	22 Ω 5 W	セメント抵抗	
	HZ00021	Cement molded resistor (fireproof)	4.7 Ω 1 B	不燃性抵抗	
	HZ00017	Fuse resistor	100 Ω 1/2 W	ヒューズ抵抗	
	FM10810	Bipolar electrolytic capacitor (vert. type)	100 μ F 6.3 WV	バイポーラニケミコン	
	FM09622	- do. - (")	2.2 μ F 16 WV	"	
	FM09747	- do. - (")	47 μ F "	"	
	FM11610	- do. - (")	1 μ F 50 WV	"	
	HT41004	Variable resistor (SV10KR)	B 4.7K Ω	ソリッドVR	
22	GD90005	Air-core coil	3 μ H	空芯コイル	
	iF00002	Diode	SD-46	ダイオード	
	iH00003	- do. -	10D-1	"	

Ref. No.	Part No.	Description		Remarks	Common Models
	iF00004	Diode	IS1555	ダイオード	
	iF00020	Zener diode	WZ-120	ツェナーダイオード	
	iA05720	Transistor	2SA572 (W-4.5)	トランジスタ	
	iA06820	- do. -	2SA682 (O or Y)	"	
	iB05310	- do. -	2SB531 (O or R)	"	
	iC04583	- do. -	2SC458 (C or D)	"	
	iC11242	- do. -	2SC1124 (-2)	"	
	iC13822	- do. -	2SC1382 (Y or O)	"	
	iD03710	- do. -	2SD371 (O or R)	"	
23	KC00009	Relay	MX-2PO	リレー	
	BB06308	Transistor clamp		トランジスタ押え	
	LB30011	Transistor socket	S2-110B-00	トランジスタソケット	
24	BA06480	Heat sink		放熱板	
②	NA06428	Power supply circuit board	# 63122	電源シート	except European Model
	NA06429	- do. -		"	European Model
	HL41527	Metal oxide resistor	270Ω 1W	酸化金属抵抗	
	HL31568	- do. -	680Ω "	"	
	HZ00030	Fuse resistor	3.9Ω 1W	ヒューズ抵抗	
	HZ00016	- do. -	3.9Ω (300 mA) ½W	"	
	HZ00014	- do. -	220Ω ½W	"	
	HZ00029	- do. -	22Ω "	"	
	iH00008	Diode	10DC-1	ダイオード	
	iH00009	- do. -	10DC-1R	"	
	iH00005	- do. -	10DC-2	"	
	iH00013	- do. -	10DC-2R	"	
	iH00011	- do. -	5B-2	"	
	iF00020	Zener diode	WZ-120	ツェナーダイオード	
	iF00022	- do. -	WZ-310	"	
	iC04583	Transistor	2SC458 (C or D)	トランジスタ	
	iC10613	- do. -	2SC1061 (B or C)	"	
26	BA06276	Heat sink		放熱板	CR-700
	LB20057	Fuse holder pin	SN-5053	ヒューズピン	
27	KB00104	Fuse (UL listed)	3.0A 250V	ヒューズ (UL規格)	except European Model