

FM STEREO/FM-AM RECEIVER

STR-V7

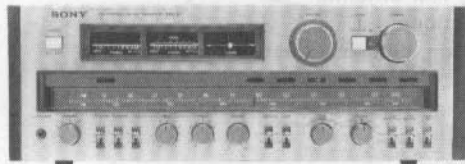

OPERATING INSTRUCTIONS

Before operating the set, please read this manual thoroughly. This manual should be retained for future reference.

The model and serial numbers are located at the bottom of the receiver. Please refer to the enclosed card for details. Refer to the back of the receiver for the location of the serial number. If you have any questions, please refer to the enclosed card for details. Model No. STR-V7.

WARNING
To prevent fire or shock hazard, do not expose the unit to rain or moisture.

Do not use the receiver in the following conditions:
1. In the presence of flammable or explosive vapors or gases.
2. In the presence of rain or moisture.
3. In the presence of high humidity or condensation.
4. In the presence of strong magnetic fields.
5. In the presence of strong electric fields.
6. In the presence of high temperatures.
7. In the presence of high altitudes.
8. In the presence of high altitudes.

On operation
Do not use the receiver in the following conditions:
1. In the presence of flammable or explosive vapors or gases.
2. In the presence of rain or moisture.
3. In the presence of high humidity or condensation.
4. In the presence of strong magnetic fields.
5. In the presence of strong electric fields.
6. In the presence of high temperatures.
7. In the presence of high altitudes.
8. In the presence of high altitudes.

OWNER'S RECORD

The model and serial numbers are located at the rear.
Record these numbers in the spaces provided below. Refer to them whenever you call upon your Sony dealer regarding this product.

Model No. STR-V7 Serial No. _____

WARNING

To prevent fire or shock hazard,
do not expose the unit to rain or moisture.

To avoid electrical shock, do not open
the cabinet.

Refer servicing to qualified personnel only.

TABLE OF CONTENTS

Unpacking	3
Precautions	3
Connection diagram	4
System connections	5
Connection notes, Power connection, Speaker connection, Program source connection, Ground connection	
Antennas	8
FM antenna, AM antenna	
Operating instructions	10
Initial operation, Sound adjustment, FM and a-m reception, Record playing, Tape playback, Tape recording, Tape copy	
Front panel facilities	12
Care of your receiver	15
Trouble checks, Cleaning	
Specifications	16
Block diagram	18
Tuner section, Audio section	

UNPACKING

Do not throw away the carton and the associated material; they will come in handy if you ever have to transport or ship your unit. Inspect your unit immediately after unpacking. If any sign of damage is found, consult your local Sony dealer. When shipping the unit for repair work or to another location, the unit should be repacked in the original carton and packing material just as it was originally.

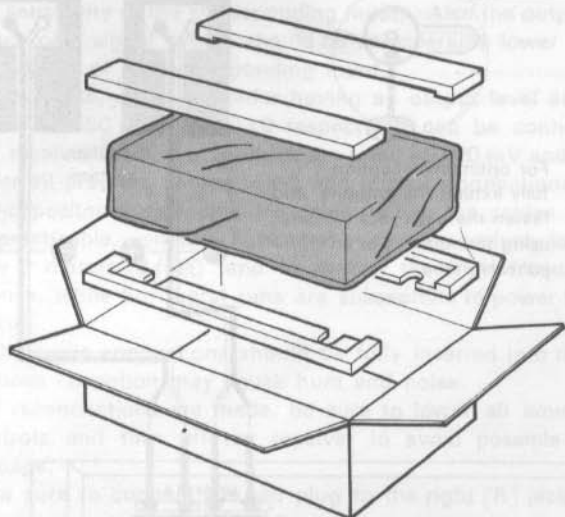

PRECAUTIONS

On safety

- Check that the operating voltage of your unit is identical with the voltage of your local power supply.
- Should any liquid or solid object fall into the cabinet, unplug the unit and have it checked by qualified personnel before operating it any further.
- Unplug the unit from the wall outlet if it is not to be used for an extended period of time. To disconnect the cord, pull it out by grasping the plug. Never pull the cord itself.
- In compliance with safety regulations, do not remove the side boards. Should it become necessary to do so, consult your nearest Sony dealer.

On installation

- Do not install the unit in a location near heat sources such as radiators or air ducts, or in a place subject to direct sunlight, excessive dust, mechanical vibration or shock.
- Good air circulation is essential to prevent internal heat build-up in the unit. Place the unit in the location with adequate air circulation. Do not place the unit on soft surfaces such as a rug that would block the ventilation holes on the bottom.
- Do not place anything on top of the cabinet. The top ventilation holes must be unobstructed for the proper operation of the unit and to prolong the life of its components.
- Do allow more than 15 cm (6 inches) of space behind the unit so that the position of the built-in ferrite-bar antenna can be adjusted.

On operation

- Do not overload the outlets from which your music system operates by simultaneously using high wattages devices such as electric irons or hair dryers.
- Before making program source connections, be sure to turn the power switch off and unplug the unit.
- Do not attempt to test the protection circuits by blocking the ventilation holes or connecting improper loads.
- When the unit is not used, turn the power off, to conserve energy and to extend the useful life of your unit.
- If any problem arises in the operation of this unit, such as no sound from the one or both channels, etc., first follow the procedures suggested in "TROUBLE CHECKS" on page 15. Most problems that arise are the result of a simple misconnection or incorrect operation and can be cleared up easily. If the difficulty still persists, contact your nearest Sony dealer.

CONNECTION DIAGRAM

For detailed information about connection, refer to the page in the parentheses.

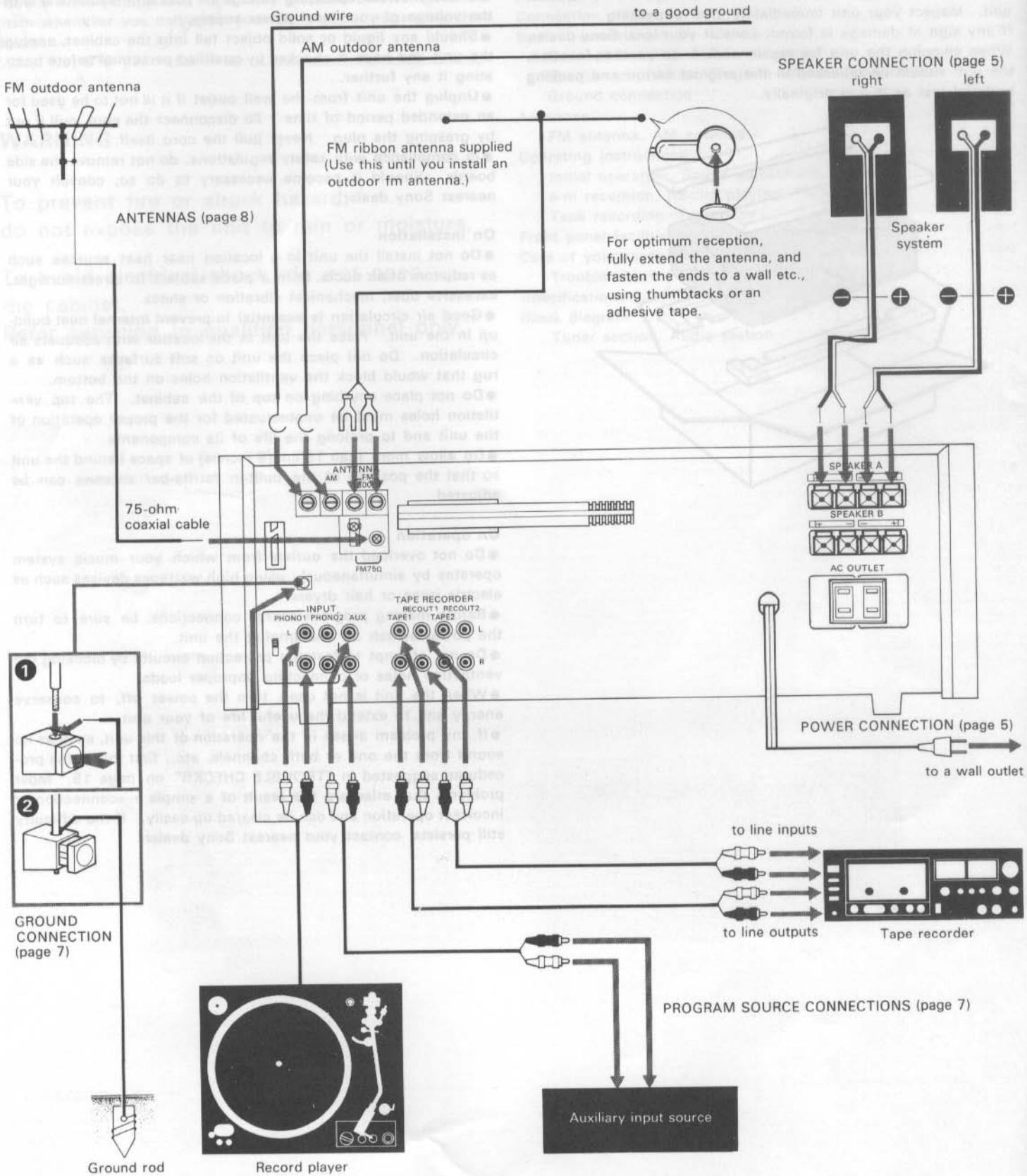

SYSTEM CONNECTIONS

CONNECTION NOTES

- To assure correct matching at the input and output terminals of your audio system, refer to the "SPECIFICATIONS" on page 16, and to the specifications given in the instruction manuals provided with the components you wish to connect to the receiver. Generally the output level of a signal source (phono cartridge, tape recorder, etc.) should be equal to or slightly greater than the sensitivity of the corresponding input. Also the output impedance of a signal source should be considerably lower than the impedance of the corresponding input.

For example, a tape recorder having an output level and impedance of 250 mV and 10 kΩ respectively can be connected to the receiver TAPE inputs which are rated at 150 mV and 100 kΩ.

- For all program source input and output connections, use a low-capacitance type shielded cable. Keep the cables as short as practicable, avoiding horizontal runs. Excessively-long runs over 2 meters (6 feet) tend to reduce the high frequency response, while horizontal runs are susceptible to power line hum pickup.

- The cable connections should be fully inserted into the jacks. A loose connection may cause hum and noise.

- If reconnections are made, be sure to lower all source level controls and turn off the receiver to avoid possible speaker damage.

- Be sure to connect the red plug to the right [R] jack and the remaining one to the left [L].

POWER CONNECTION

Before making any form of power connection, make sure the receiver POWER switch is OFF. Then plug the ac power cord into a wall outlet.

Receptacles on the rear panel provide a convenient source of ac power for other system components.

A SWITCHED outlet is controlled by the POWER switch and can supply ac power up to 100 watts.

An UNSWITCHED outlet with a 300 watt rating is not controlled by the front panel POWER switch.

- Never run electrical home appliances such as an electric iron, fan or TV from these outlets.

SPEAKER CONNECTION

This receiver has provision for two pairs of speaker systems—system A and system B—which can be selected either individually or simultaneously by means of the front panel SPEAKERS selector. Note that the speaker systems A and B are series-connected. No sound will be heard if only one of the speaker systems is used with the SPEAKERS selector at "A+B" position.

Caution

The receiver is rated at 150 watts minimum RMS per channel with an 8-ohm load from 20–20,000 Hz and may deliver an

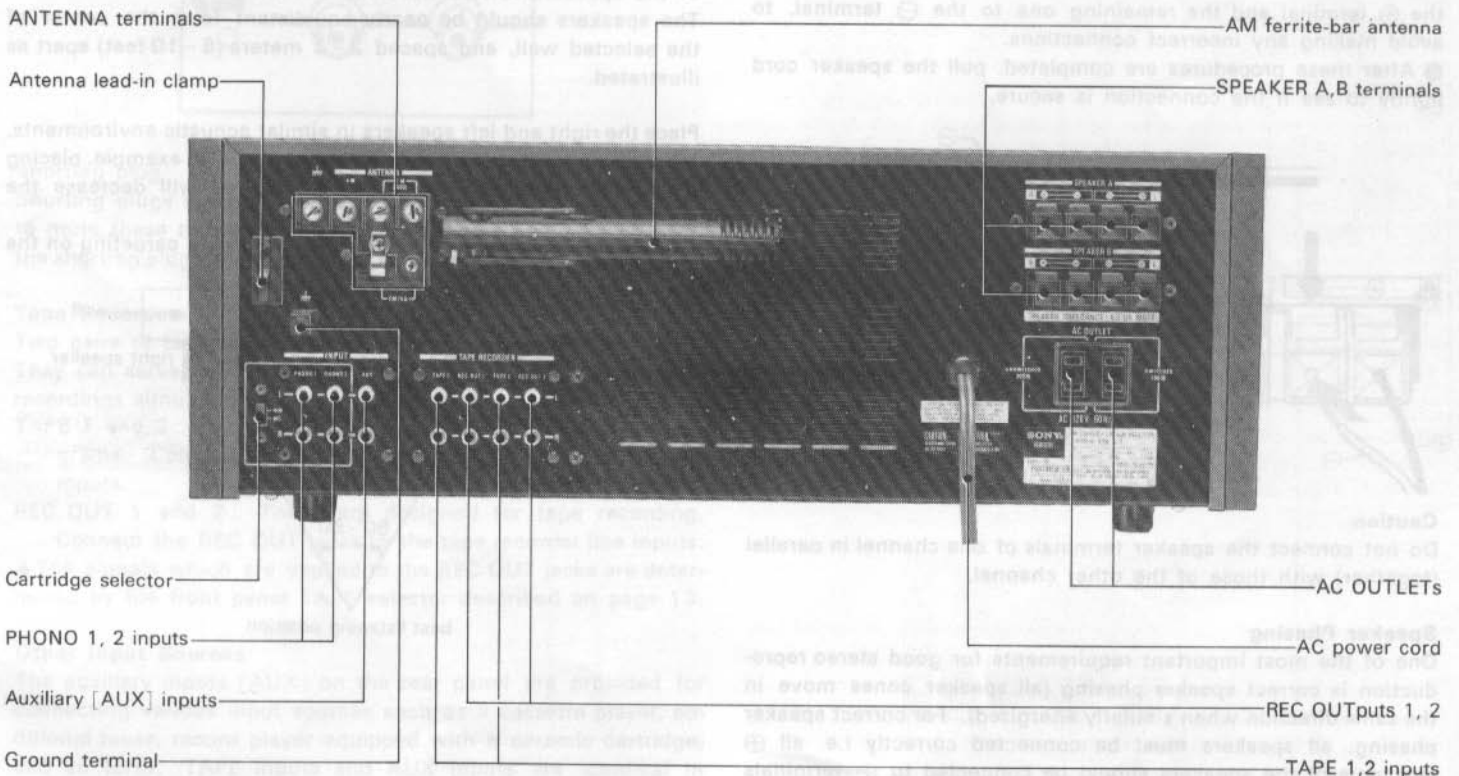

instantaneous peak power much greater than the rated power. Be sure to use speakers with adequate power handling capabilities. Always reduce the volume, when setting down or removing a tonearm or when tuning across the band. Speaker damage may result if these precautions are not observed.

Speaker Impedance

This receiver is designed to work best with speakers having nominal ratings from 8 to 16 ohms.

Care should be taken that the speaker impedance should not be less than the lowest indicated value (8 ohms) on the rear panel.

Speaker Cable Type

The type of wire used to connect the speakers to the receiver is not critical in most home stereo systems.

Common 18-gauge lamp cord (the center conductor of 1 mm in diameter) is fine for short runs. However, 16-gauge (1.3 mm) to 14-gauge (1.6 mm) may be needed for long runs to prevent excessive power losses in the wiring.

Connecting Speaker Cord to the Receiver

Connect each speaker to the corresponding receiver speaker terminals i.e. right speaker to the \oplus speaker terminals and left speaker to the \ominus speaker terminals.

- 1 Strip approx. 15 mm (5/8") of outer covering from the speaker cord.
- 2 Twist the wire ends for easy insertion. Do not coat with solder.
- 3 Fully insert the twisted wires into the slot and depress the terminal button.

Note that the colored or marked lead of a speaker cord goes to the \oplus terminal and the remaining one to the \ominus terminal, to avoid making any incorrect connections.

- 4 After these procedures are completed, pull the speaker cord lightly to see if the connection is secure.

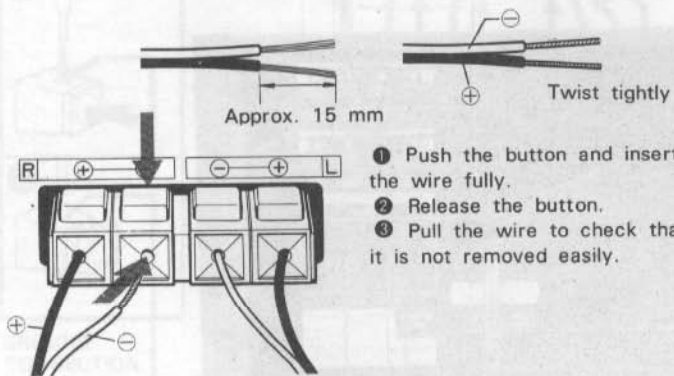

Caution

Do not connect the speaker terminals of one channel in parallel (together) with those of the other channel.

Speaker Phasing

One of the most important requirements for good stereo reproduction is correct speaker phasing (all speaker cones move in the same direction when similarly energized). For correct speaker phasing, all speakers must be connected correctly i.e. all \oplus terminals of the speakers should be connected to \oplus terminals of the receiver, and \ominus to \ominus . If one connection is reversed, all others must also be changed. Otherwise the speaker phasing all becomes reversed so that the bass tones seem to be missing and the position of the instruments becomes obscure.

Proper phasing

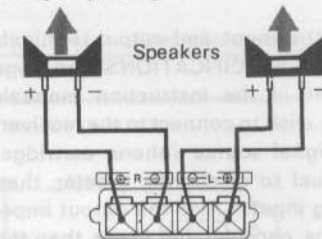

Both speaker cones move in the same direction.

Improper phasing

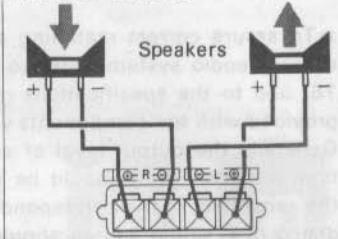

The \oplus \ominus connections of right speaker are reversed, so two cones move in the opposite direction.

Speaker Placement

Here are a few suggestions for speaker placement that will assist you in obtaining an installation with satisfactory stereo sound. Normally, the speakers are placed on the floor against the narrower wall of a room. The bass sounds can then be increased by moving the speakers toward the corners, or decreased by raising the speakers off the floor on suitable pedestals, and/or moving them away from the wall a moderate distance. If the speakers are positioned above the floor, do not place them higher than ear level while seated, since this produces an unnatural effect.

However, moving the speakers toward the corners in a large room, while increasing the bass, results in a "hole in the middle" effect which can be partially counteracted by angling the front of the speakers toward the center of the room.

The speakers should be nearly equidistant from the center of the selected wall, and spaced 2 - 3 meters (6 - 10 feet) apart as illustrated.

Place the right and left speakers in similar acoustic environments, otherwise you will obtain unbalanced sound. For example, placing one speaker near an open door or archway will decrease the apparent bass from that speaker.

sound is usually obtained in a room with carpeting on the

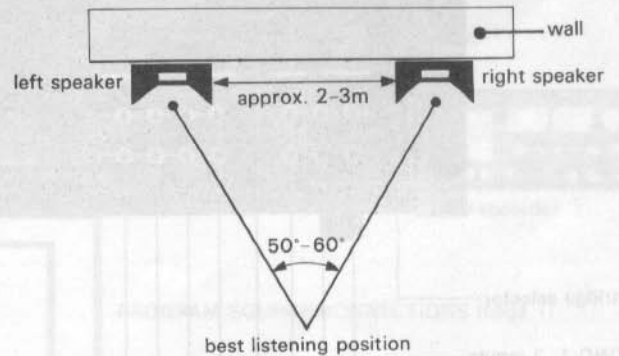

floor, and having heavy draperies and upholstered furniture. Since each room has its own individual acoustic characteristics, which are a function of its size, construction and furnishings, some experimentation with speaker placement is generally necessary before the correct balance of stereo image and bass response is obtained. This will be time well spent, resulting in your enjoyment of the maximum capabilities of your music system.

PROGRAM SOURCE CONNECTIONS

Record Players

This receiver features two sets of phono input terminals. These PHONO 1 and PHONO 2 inputs accept moving-magnet, induced-magnet or moving-coil cartridges. The phono input sensitivity is 2.5 mV and the input impedance is a standard load of 50 k ohms at the MM position; at the MC position 0.25 mV, 100 ohms.

Cartridge selector (on the rear panel)

Set this cartridge selector to MM position, when a record player with a moving-magnet or induced-magnet cartridge is connected to the PHONO 1 or/and PHONO 2 inputs.

When using a moving-coil cartridge, set this selector to MC.

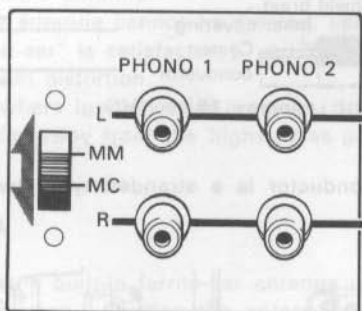

Shorting plug

Shorting plugs inserted to the PHONO input terminals activate to mute these terminals when they are not in use. Never insert the shorting plugs in any output or input jacks other than PHONO.

Tape Recorders

Two pairs of tape recorder connectors (1 and 2) are provided. They can serve for direct tape duplication or for making two recordings simultaneously.

TAPE 1 and 2: These are designed for playing back tape programs. Connect the tape recorder line outputs to the TAPE inputs.

REC OUT 1 and 2: These are designed for tape recording. Connect the REC OUT jacks to the tape recorder line inputs.

● The signals which are applied to the REC OUT jacks are determined by the front panel TAPE selector described on page 13.

Other Input Sources

The auxiliary inputs [AUX] on the rear panel are provided for connecting various input sources such as a cassette player, additional tuner, record player equipped with a ceramic cartridge, and so forth. TAPE inputs and AUX inputs are identical in sensitivity and input impedance.

GROUND CONNECTION

When an outdoor antenna is installed, the direct connection of the ground terminal [] on the antenna terminal plate to a good ground is recommended for lightning protection. The use of a lightning arrester is recommended for any outdoor antenna. To prevent hum, be sure to connect the ground wire of the record player to the ground terminal. If hum still exists, it may be helpful to connect the ground terminal directly to earth via a ground rod or other good ground, such as a clamp on a cold water pipe.

Ripcord cable and coaxial antenna pick up signals from both front and rear equally well.

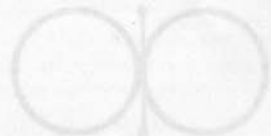

Dipole antenna with reflector has increased sensitivity to front signals and reduced sensitivity to rear signals.



Yagi element type has narrow beam pattern with high front-to-back ratio and superior rejection of rear signals.



FM Antenna Connection
The tuner accepts either 300-ohm twin lead or 75-ohm coaxial cable. Standard 500-ohm twin lead is inexpensive and will be adequate for most installations. However, in cases where local noise or multipath pickup on the transmission line causes interference a shielded transmission line must be used. In locations where ignition noise is severe, the antenna should be located as far away from the highway as possible, and the lead-in should preferably be of the coaxial type.

To avoid excessive loss of signal strength and to minimize undesired pickup on the line when using standard 300-ohm twin lead observe the following precautions:
Use commercially available stand-off insulators to route the lead over the roof overwall, etc.
Keep the lead as short as possible and avoid long horizontal runs.

ANTENNAS

FM ANTENNA

Good fm reception depends not only on the receiver sensitivity but on the quality of the received signals. This is determined by the signal strength, the presence of multipath signal and the geographic location of the desired fm stations. To get the best from your receiver, use an antenna suited to your location. Until you install a suitable one, the supplied ribbon antenna may be useful.

In a strong signal area, the familiar "rabbit-ear" antenna is simple to install and is usually suitable for fm reception, since it can be adjusted easily for best signal pickup. If there are many high structures nearby, and evidence of strong multipath reception is present, use a highly-directional rotatable outdoor antenna.

Ribbon dipole and rabbit-ear antennas pick up signals from both front and rear equally well.

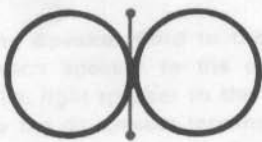

Dipole antenna with reflector has increased sensitivity to front signals and reduced sensitivity to rear signals.

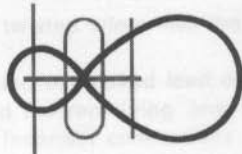

Multi-element type has narrower pickup pattern with high frontal sensitivity and superior rejection of rear signals.

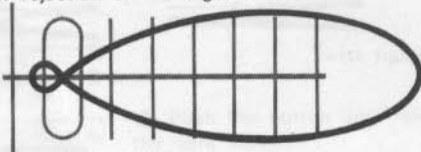

FM Antenna Connection

The tuner accepts either 300-ohm twin lead or 75-ohm coaxial cable. Standard 300-ohm twin lead is inexpensive and will be adequate for most installations. However, in cases where local noise or multipath pickup on the transmission line causes interference, a shielded transmission line must be used. In locations where ignition noise is severe, the antenna should be located as far away from the highway as possible, and the lead-in should preferably be of the coaxial type.

To avoid excessive loss of signal strength and to minimize undesired pickup on the line when using standard 300-ohm twin lead, observe the following precautions.

- Use commercially-available stand-off insulators to route the lead over the roof, outerwall, etc.
- Keep the lead as short as possible and avoid long horizontal runs.

- Cut off the unused portion of the lead at the tuner input, rather than folding or bunching it together.

300-ohm twin lead connection

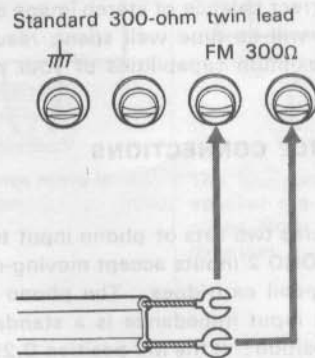

75-ohm coaxial cable connection

- 1 Cut and remove the outer covering, shield braid, inner covering as follows, and fold back most of the shield braid. Be careful not to damage the center conductor.

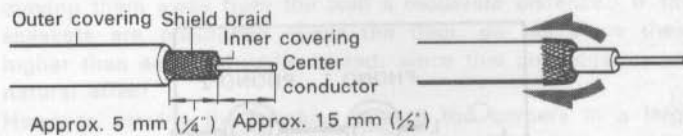

If the center conductor is a stranded type, twist the strands tightly together.

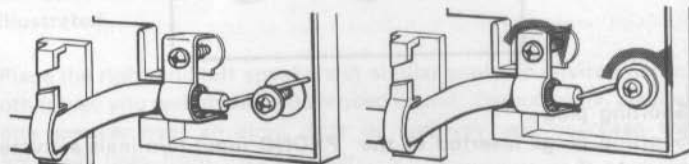

- 2 Loosen the screws on the FM 75Ω ANTENNA plate and terminal. Pass the cable under the plate, wind the center conductor round the terminal of the FM 75Ω ANTENNA and tighten screws and terminal.

Multipath Reception

The most important factor affecting fm signal quality is multipath reception. Multipath is caused by signal reflections from hills or structures that reach the receiving antenna perceptibly later in time. Particularly with fm stereo multipath can cause severe distortion and complete loss of channel separation. The effects of a multipath condition appear as high-frequency noise and distortion, particularly noticeable in music systems with extended response. The effects of multipath reception can be avoided to a great extent by using a coaxial lead-in, and good directional antenna that is correctly oriented.

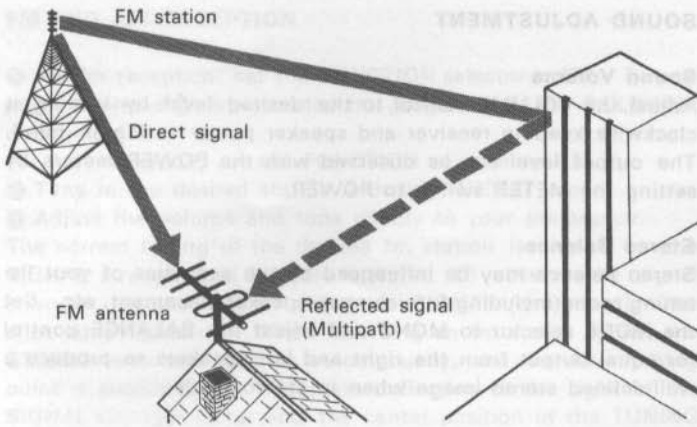

FM Antenna Orientation

While listening to the desired fm station adjust the antenna direction and height so that the SIGNAL strength meter shows the right-most deflection by setting the METER switch to SIGNAL and that the distortion is eliminated.

- In some cases multipath reception on two or more stations may require that the antenna be pointed in different directions. An effective solution to this problem is the use of a remotely-controlled rotatable antenna.
- If an outdoor antenna cannot be erected, use a good indoor antenna ("rabbit-ear" is satisfactory). Adjust the antenna direction for minimum distortion.
- In locations where ignition noise is severe, the antenna should be located as far away from the highway as possible.

AM ANTENNA

In most areas, the built-in ferrite-bar antenna will provide satisfactory a-m reception. Position the antenna on the rear panel as shown for best reception.

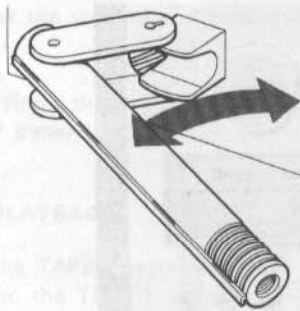

In difficult reception areas, it may be necessary to connect a length of insulated wire 5 - 15 meters (20 - 50 feet) long to the AM ANTENNA terminal. Extend this out of doors if possible, keeping the greater portion horizontal. The signal strength is indicated on the SIGNAL strength meter by setting the METER switch to SIGNAL ; the stronger the signal the greater the deflection to the right.

INITIAL OPERATION
 As a preliminary to initial operation, check the POWER switch is in the ON position and the speaker is connected to the power outlet.
 Before proceeding to any type of operation, set the controls and switches as shown in the illustration. (Radio on, volume control, etc.)
 The number shown in the diagram of the controls and switches is for reference only.
 Set the VOLUME control at minimum position (fully counter-clockwise) and set the TUNING dial to the desired station.
 Select the desired program source as follows:

FUNCTION	TAP	Program
FM	FM	FM tone
AM	AM	AM tone
AUX	AUX	Auxiliary sources
Tape 1 or Tape 2	Tape 1 or Tape 2	Taped program

Adjust the POWER switch to ON.
 This receiver employs a muting circuit which provides several seconds delay after switch-on to avoid any annoying "thump" noise when the unit is first turned on.
 Your receiver is now ready for operation, and you can proceed with the sound adjustments.

Basic control settings

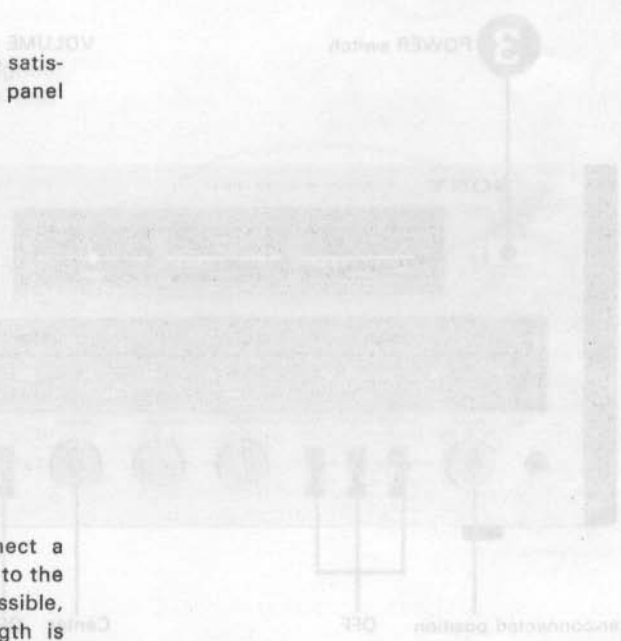

OPERATING INSTRUCTIONS

INITIAL OPERATION

As a preliminary to initial operation, check that the POWER switch is released (OFF) and plug the receiver into a suitable power outlet.

Before proceeding to any type of operation, set the controls and switches as shown in the illustration "Basic control settings". The numbers refer to the sequence of operations.

- 1 Set the VOLUME control at minimum position (fully counter-clockwise).
- 2 Select the desired program source as required.

Program	TAPE	FUNCTION
FM tuner	SOURCE	FM
AM tuner		AM
Record playing		PHONO 1 or PHONO 2
Auxiliary sources		AUX
Taped program	TAPE 1 or TAPE 2	any

- 3 Depress the POWER switch to ON. This receiver employs a muting circuit which provides several seconds delay after switch-on to avoid any annoying "thump" noises when the unit is first turned on. Your receiver is now ready for operation, and you can proceed with the sound adjustments.

Basic control settings

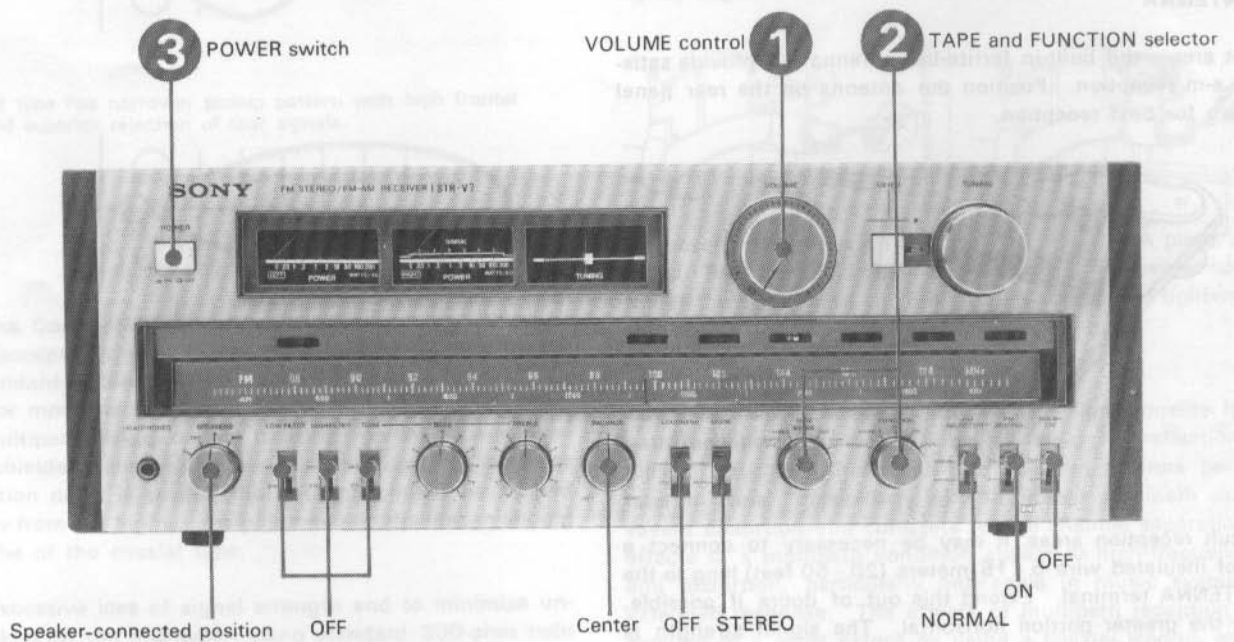

SOUND ADJUSTMENT

Sound Volume

Adjust the VOLUME control to the desired level by turning it clockwise keeping receiver and speaker power rating in mind. The output level can be observed with the POWER meters by setting the METER switch to POWER.

Stereo Balance

Stereo balance may be influenced by the acoustics of your listening room (including furnishings), speaker placement, etc. Set the MODE selector to MONO and adjust the BALANCE control for equal output from the right and left speakers to produce a well-defined stereo image when in stereo mode.

Tone

The manipulation of the tone control section does not interrupt the signal path in the receiver. However, its overuse may adversely affect receiver tone quality. For proper use, refer to the "TONE CONTROL SECTION" on page 13.

FM AND AM RECEPTION

① For fm reception, set the FUNCTION selector to FM. To properly receive a Dolby encoded fm program, set the DOLBY FM switch to ON.

For a-m reception, set the FUNCTION selector to AM.

② Tune in the desired station with the TUNING knob.

③ Adjust the volume and tone quality to your preference.

The correct tuning of the desired fm station is shown by the SIGNAL strength and TUNING meters. To observe the signal strength, set the METER switch to SIGNAL (depressed). The pilot lamp lights up. When receiving an fm stereo signal, the STEREO lamp will light up automatically, and the best tuning point is shown by the maximum deflection to the right of the SIGNAL strength meter and the center position of the TUNING meter.

For a-m reception, the correct tuning is shown by the maximum deflection of the SIGNAL strength meter after depressing the METER switch.

Notes

● To tune in a very weak fm station, lower the volume of the receiver, and set the FM MUTING switch to OFF.

● Be sure to release the DOLBY FM switch when receiving non-Dolby encoded fm programs.

● When stereo signals are too weak, the STEREO lamp will flicker. If this happens, adjust the antenna to prevent an annoying fluctuation between stereo and mono reception.

If the noise persists, set the MODE selector to MONO position for the best possible signal under noise conditions.

RECORD PLAYING

① Set the FUNCTION selector to PHONO 1 for the disc program connected to the PHONO 1 jacks, or to PHONO 2 for the disc program connected to the PHONO 2 jacks.

② Play the record.

③ Adjust the volume and tone quality to your preference.

Note

When using a moving-coil cartridge, set the cartridge selector on the rear panel to MC.

TAPE PLAYBACK

① Set the TAPE selector to TAPE 1 for the tape program connected to the TAPE 1 jacks, or to TAPE 2 for the tape program connected to the TAPE 2 jacks.

② Start the tape playback.

③ Adjust the volume and tone quality to your preference.

TAPE RECORDING

① Set the TAPE selector to SOURCE.

② Select the program to be recorded with the FUNCTION selector.

③ Adjust the recording level at the recorder and start it in record mode.

④ Play the desired program.

Notes

● The VOLUME, BALANCE controls, FILTER, TONE, LOUDNESS switches have no effect upon the recording.

● You can make two recordings simultaneously by using two tape recorders.

Monitoring of a 3-head tape recorder

If your tape recorder has separate record and playback heads, you can monitor the recording results by setting the TAPE selector to TAPE 1 or TAPE 2 position. In this case, the recorder should be connected to the TAPE and REC OUT jacks, and its monitor switch should be set to TAPE position.

TAPE COPY

You can copy a tape program from one tape recorder to another by positioning the TAPE selector to COPY 1→2 or COPY 2→1, while listening to the taped program being copied.

① Set the TAPE selector to COPY 1→2 for the copy from tape recorder 1 to 2.

② Adjust the recording level of tape recorder 2, and start it in record mode.

③ Start the playback of tape recorder 1. The copy will begin.

In the same way, you can copy a tape from tape recorder 2 to 1.

METER SECTION

① METER SWITCH

For visual check of the SIGNAL strength, the lamp will illuminate when the METER switch is depressed.

② HEADPHONE

Headphone output for listening to the program being recorded.

③ SPEAKER

Speaker output for listening to the program being recorded.

④ FILTER

Filter control for adjusting the frequency response of the program being recorded.

⑤ TONE

Tone control for adjusting the frequency response of the program being recorded.

⑥ BASS and TREBLE

Bass and treble controls for adjusting the frequency response of the program being recorded.

⑦ BALANCE

Balance control for adjusting the frequency response of the program being recorded.

FRONT PANEL FACILITIES

This section illustrates each facility available on the front panel of the STR-V7, and describes its operation and function. Each number in the illustration is keyed to the descriptive text. For clarity, the descriptive text is grouped into six functionally related sections.

GENERAL CONTROL SECTION

1 POWER switch

Depress it to apply power to the receiver. The dial scale, POWER meters and TUNING meter will light. Depressing it again will turn off the power.

3 SPEAKERS selector

Selects the desired speakers.

B: to drive the speakers connected to the SPEAKER B terminals.

OFF: to switch off all speakers.

A: to drive the speakers connected to the SPEAKER A terminals.

A+B: to drive the speakers connected to the SPEAKER A and B terminals simultaneously.

(Be sure that there are speakers connected to both SPEAKER A and B terminals when the [A+B] position is used. Otherwise, no sound will be heard because the A and B terminals are internally connected in series for such multiple operation.)

7 BALANCE control

This regulates the sound balance between right and left channels for optimum stereo effect. Clockwise rotation (to RIGHT) decreases the left-channel sound, and counterclockwise rotation (to LEFT) decreases the right-channel sound.

Normally set the control to the center detent position.

9 MODE selector

Normally keep this selector at the STEREO position, and the receiver will operate in stereo mode. If the selector is set at the MONO position, the receiver changes to the mono mode and each speaker provides mono sound. Use this position when the receiving fm stereo signals are weak or noisy, or when you adjust the stereo balance.

17 VOLUME control

Regulates the overall sound level.

Clockwise rotation increases the sound level and counterclockwise rotation decreases the volume.

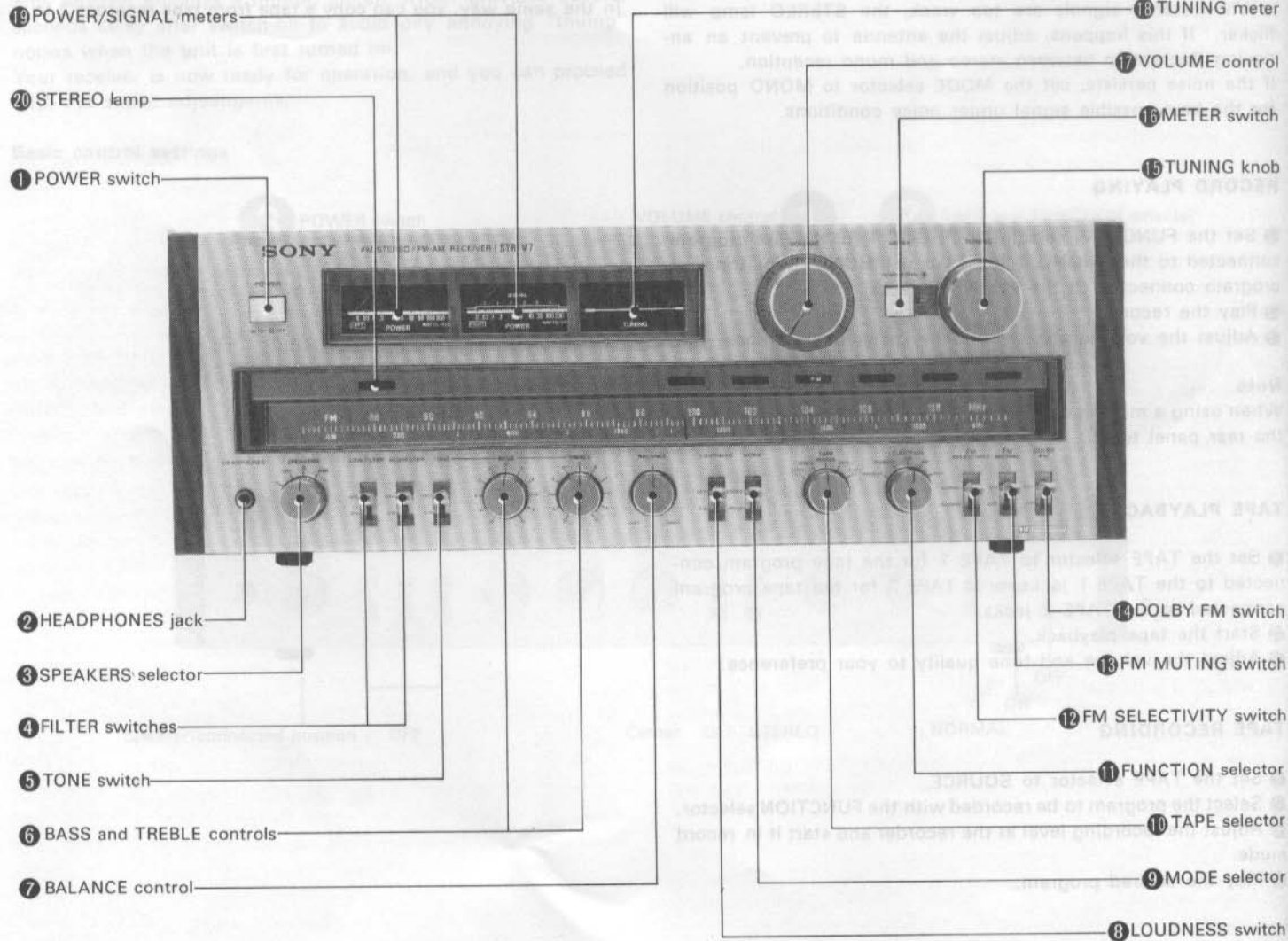

INPUT SELECTION SECTION

① FUNCTION selector

Selects the desired program source.
 PHONO 2*: for disc programs connected to the PHONO 2 jacks.
 PHONO 1*: for disc programs connected to the PHONO 1 jacks.
 FM: for fm reception.
 AM: for a-m reception.
 AUX: for an auxiliary program connected to the AUX input jacks.

⑩ TAPE selector

Selects either the playback output from tape recorder 1 or 2, or program sources other than the taped program, in addition to two-way dubbing—even you are listening to the taped program being copied.
 For normal operation, keep this selector at SOURCE position.
 COPY 1→2: For dubbing from tape recorder 1 (for playback) to tape recorder 2 (for recording).
 TAPE 1: For playback of tape recorder 1.
 SOURCE: For program sources such as a record player, tuner or auxiliary source.
 TAPE 2: for playback of tape recorder 2.
 COPY 2→1: For dubbing from tape recorder 2 (for playback) to tape recorder 1 (for recording).

TONE CONTROL SECTION

④ FILTER switches

The purpose of a filter is to attenuate selected portion of the audio frequency spectrum. LOW and HIGH FILTER switches are provided which have an attenuation slope of 6 dB per octave for eliminating unwanted noise components present in the program source. Use these filters judiciously with imperfect program sources because the wanted signals may be reduced as well as the unwanted noise. If there is no need for the use of a filter, set the FILTER switches to OFF position.

LOW: reduce the low-frequency noise from turntable or tape recorder motor, or rumble created by turntable or record changers, or warped records.

HIGH: reduce the high-frequency noises such as the surface noise of a disc (scratch noise) or tape (tape hiss), the high-frequency distortion of disc or tapes, and the hiss of off-the-air programs.

⑤ TONE switch

OFF: An absolutely flat frequency response is obtained (provided the FILTER switches are both OFF), regardless of the BASS and TREBLE controls settings.
 ON: The BASS and TREBLE controls work normally.

⑥ BASS and TREBLE controls

The tone controls manipulate when the TONE switch is set to ON. These controls are useful for compensating any deficiency in your speaker system or listening room acoustics, correcting improperly equalized program source material, and so forth.

* The rear panel includes a cartridge selector which will optimize the load and gain for moving-coil cartridges as well as moving-magnet cartridges to provide adequate signal level. Set it according to the cartridge type used.

These two controls each cause a response change of ± 10 dB. When both are in center position, a flat response results (provided both FILTER switches are OFF).

BASS: Clockwise rotation boosts and counterclockwise rotation reduces bass frequencies respectively.

TREBLE: Clockwise rotation boosts and counterclockwise rotation reduces treble frequencies respectively.

⑧ LOUDNESS switch

When listening to the program sources at low volume level, set this switch to ON position.

Human ears are less sensitive in their response to very low and very high notes at low levels. This loudness network compensates for this characteristic of the ear, and provides an apparently uniform response at such low volume levels.

For normal operation, set this switch at OFF position.
 • The loudness effect will gradually decrease as the volume is increased.

FRONT PANEL TERMINAL SECTION

② HEADPHONES jack

This jack accepts any low or high impedance stereo headphones. For headphone monitoring only, set the SPEAKERS selector to OFF position.

METER SECTION

⑩ METER switch

For visual check of the SIGNAL meter, depress this switch. The lamp will illuminate in red. For power-output reading, release this switch.

⑫ TUNING meter

While receiving FM programs, this meter acts as a center-of-channel indicator; correct tuning is indicated by a center reading. When the dial indicator comes near the station, the meter pointer will swing either to the left or right, and the pointer will return to the center position at the channel center of the selected station as the correct tuning point is reached. Detuning from the center point will also cause the pointer to move to the right or left, and it will return to the center again when detuned completely.

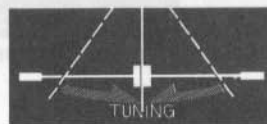

19 POWER/SIGNAL meters

These meters provide a visual check of power output and the signal strength of f-m and a-m broadcast stations. When the METER switch is released, both the meters serve as POWER meters and when depressed, the right meter functions as a SIGNAL meter.

As POWER meters: These meters, calibrated in rms watts, indicate the power output of the receiver over the range of 0 to 200 watts (into an 8 ohm load). When connecting speakers with other than 8-ohm-impedance loads, meter readings do not indicate actual power output. For a 16-ohm speaker, multiply the meter reading by 1/2.

As a SIGNAL meter: Relative strength of received signals is shown by the amount of pointer deflection. The maximum pointer deflection to the right means best tuning of the station. If the pointer always read 0-1 (see upper scale), the signal level is too weak for full performance. In this case, adjust the antenna.

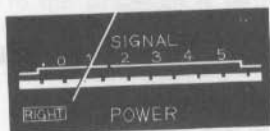
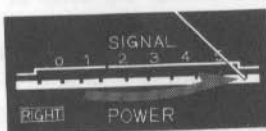

TUNER SECTION

20 FM SELECTIVITY (i.e. bandwidth) switch

Normally keep this switch in the NORMAL position. At this position, lowest distortion and higher stereo separation is available. If a station adjacent to the desired one causes interference, set this switch to NARROW. At this position, the selectivity will increase—though distortion may also increase a bit—and narrow-bandwidth reception will be obtained.

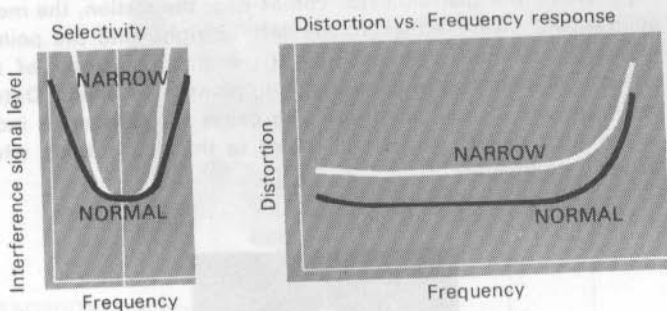

21 FM MUTING switch

Normally keep this switch in ON position to eliminate fm interstation noise while tuning from station to station. Very weak stations are also muted along with the noise, and must be tuned in with the switch at OFF. In this case, keep the volume down to avoid speaker damage caused by the interstation noise.

22 DOLBY FM switch*

Set this switch to ON when receiving Dolby encoded fm programs. The DOLBY FM lamp will light. Be sure to set this switch to OFF for the reception of most present fm programs.

23 TUNING knob

Selects the desired fm or a-m station.

24 STEREO lamp

This lamp will light when an stereo program of sufficient signal strength is tuned in with the MODE selector set to STEREO.

* "Dolby" and the double-D symbol are trade marks of Dolby Laboratories Inc. Noise reduction system manufactured under license from Dolby Laboratories Inc.

CARE OF YOUR RECEIVER

TROUBLE CHECKS

The following chart will help correct most troubles which may occur with the unit. If the trouble persists after you have made these checks, consult your Sony Service Station or dealer. Before going through the check list of specified troubles below, first refer back to the "CONNECTION DIAGRAM" on page 4 and "INITIAL OPERATION" on page 10.

Off-the-air programs

The SIGNAL strength meter is unstable.

Adjust the antenna.

The STEREO lamp does not light when receiving stereo programs.

Set the MODE selector to STEREO.

Severe hum or noise

- Tune accurately.
- Use shielded antenna lead.
- Avoid long horizontal runs of antenna lead.
- Adjust the antenna.

Ignition noise

- Install the antenna away from heavy traffic.
- Use a coaxial cable for fm antenna connection.

Other program sources

No audio

- Depress the POWER switch.
- Check that the ac power cord is plugged into a working outlet.
- Check speaker cord connections.
- Set the TAPE selector to SOURCE for program sources other than TAPE inputs.
- Check the setting of FUNCTION selector.
- Check the SPEAKERS selector setting.
- Turn up the volume.

Unbalanced left and right volume

- Adjust the BALANCE control.
- Check the level or balance controls of the signal source.

Abrupt loss of sound from one or both speakers*

- Check the speaker terminals or speaker cord for a short.

Abrupt loss of sound from both speakers, and unit is extremely hot*.

- Remove any objects on the top or the cabinet which might prevent normal air circulation.

No tone control adjustment

- Set the TONE switch to ON.

No tape recording

- Check that the TAPE selector setting.

No tape copying

- Check that the TAPE selector to see if it is correctly set.

Reversed left and right sound

- Check the speaker cord connection and speaker location.

Lack of bass or obscure instrument position

- Check the speaker connection for proper phasing.

Severe hum or noise

- Use shielded connecting cord.
- Keep the connecting cord away from transformers or motors and at least 3 meters (10 feet) from TV sets and fluorescent lights.
- Ground the receiver.

Rustling noise

- Make secure connections.
- Wipe the plugs and jacks with a cloth lightly dampened with methanol.

CLEANING

Clean the cabinet, panel and knobs periodically with a soft cloth. If finger prints, food and beverage stains, etc. are difficult to remove, use a cloth moistened with a mild detergent solution. Do not use any type of scouring powder, abrasive pad or solvent, since these will damage the cabinet.

* These symptoms may be caused when the protection circuits activate.

SPECIFICATIONS

AUDIO POWER SPECIFICATIONS

POWER OUTPUT AND TOTAL HARMONIC DISTORTION

With 8-ohm loads, both channels driven, from 20-20,000 Hz; rated 150 watts per channel minimum RMS power, with no more than 0.07% total harmonic distortion from 250 milliwatts to rated output.

OTHER SPECIFICATIONS

Amplifier section

Damping factor 40 at 1 kHz, 8 ohms
 Intermodulation (IM) distortion (60 Hz : 7 kHz = 4 : 1)
 Less than 0.07% at rated output
 Less than 0.05% at 1 W output
 Residual noise Less than 0.3 mV (A-network)

Inputs

Measured with rated output power into 8-ohm loads (both channels driven simultaneously) at 1 kHz.

		Sensitivity	Impedance	S/N	Weighting network
PHONO 1, 2	MM	2.5 mV	50 k ohms	80 dB	A
	MC	0.25 mV	100 ohms	65 dB	
AUX TAPE 1, 2		150 mV	100 k ohms	100 dB	A

Outputs

(with rated input, FM 30% modulation, speaker rated output)

	Voltage	Impedance
REC OUT 1, 2	150 mV	4.7 k ohms

Headphones output Accepts 8-ohm to 10 k-ohm headphones.
 Speaker output 8-ohm to 16-ohm speakers are suitable.
 Frequency response PHONO 1, 2
 RIAA equalization curve ± 0.5 dB
 AUX TAPE 1, 2 } 5 Hz - 50 kHz $\begin{matrix} +0 \\ -2 \end{matrix}$ dB
 Tone controls BASS ± 10 dB at 100 Hz
 TREBLE ± 10 dB at 10 kHz
 Filters HIGH 6 dB/oct. above 9 kHz
 LOW 6 dB/oct. below 50 Hz
 Loudness control (att. 30 dB)
 +10 dB at 50 Hz
 +3 dB at 10 kHz

FM Tuner Section

Tuning range 87.5 MHz - 108 MHz
 Antenna 300 ohm balanced
 75 ohm unbalanced
 Intermediate frequency 10.7 MHz
 Sensitivity at 50 dB quieting
 14.2 dBf, 2.8 μ V (MONO)
 37.3 dBf, 40 μ V (STEREO)
 Usable sensitivity 9.3 dBf, 1.6 μ V
 Signal-to-noise ratio 75 dB (MONO)
 70 dB (STEREO)

Harmonic distortion

	MONO		STEREO	
	NORMAL	NARROW	NORMAL	NARROW
100 Hz	0.08%	0.2%	0.15%	0.4%
1 kHz	0.08%	0.2%	0.15%	0.4%
10 kHz	0.1%	0.2%	0.3%	0.6%

IM distortion

	MONO		STEREO	
	NORMAL	NARROW	NORMAL	NARROW
	0.08%	0.2%	0.15%	0.4%

Separation

	NORMAL	NARROW
100 Hz	40 dB	35 dB
1 kHz	48 dB	40 dB
10 kHz	43 dB	37 dB

Frequency response 30 Hz - 15 kHz ± 00 dB
 Selectivity at 400 kHz

50 dB (NORMAL)
 80 dB (NARROW)

Capture ratio 1.0 dB
 AM suppression ratio 60 dB
 Image response ratio 80 dB
 IF response ratio 100 dB
 Spurious response ratio 100 dB
 RF intermodulation 70 dB
 Sub-carrier product ratio

60 dB
 SCA rejection ratio 60 dB
 Muting threshold Approx. 5 μ V

AM Tuner Section

Tuning range	530 kHz – 1,605 kHz
Antenna	Built-in ferrite-bar antenna External antenna terminal
Intermediate frequency	455 kHz
Usable sensitivity	200 μ V/m, built-in antenna 100 μ V, external antenna at 1,000 kHz
Signal-to-noise ratio	50 dB at 50 mV/m
Harmonic distortion	0.5% at 50 mV/m, 400 Hz
Selectivity	40 dB at 10 kHz
Image response ratio	40 dB at 1,000 kHz
IF response ratio	40 dB at 1,000 kHz

General

System	Tuner section : Superheterodyne fm/ a-m tuner Power amp section : Direct-coupled pure complementary parallel push-pull circuitry Preamp section : Three-stage equalizer amp in direct-coupled design, NF type tone control amp
Semiconductors	8 ICs, 4 FETs, 69 transistors, 36 diodes
Power requirements	120 V ac , 60 Hz
Power consumption	250 W (for the USA model) 550 VA (for the Canadian model)
AC outlets	1 switched, 100 W 1 unswitched, 300 W
Dimensions	Approx. 522x192x450 mm (w/h/d) (20 1/2x7 1/2x17 3/4 inches) including projecting parts and controls
Weight	Approx. 21.9 kg (48 lbs 6 oz) net Approx. 24.1 kg (53 lbs 2 oz) in shipping carton
Supplied accessories	FM ribbon antenna 1 Shorting plug 2 Polishing cloth 1

Design and specifications subject to change without notice.

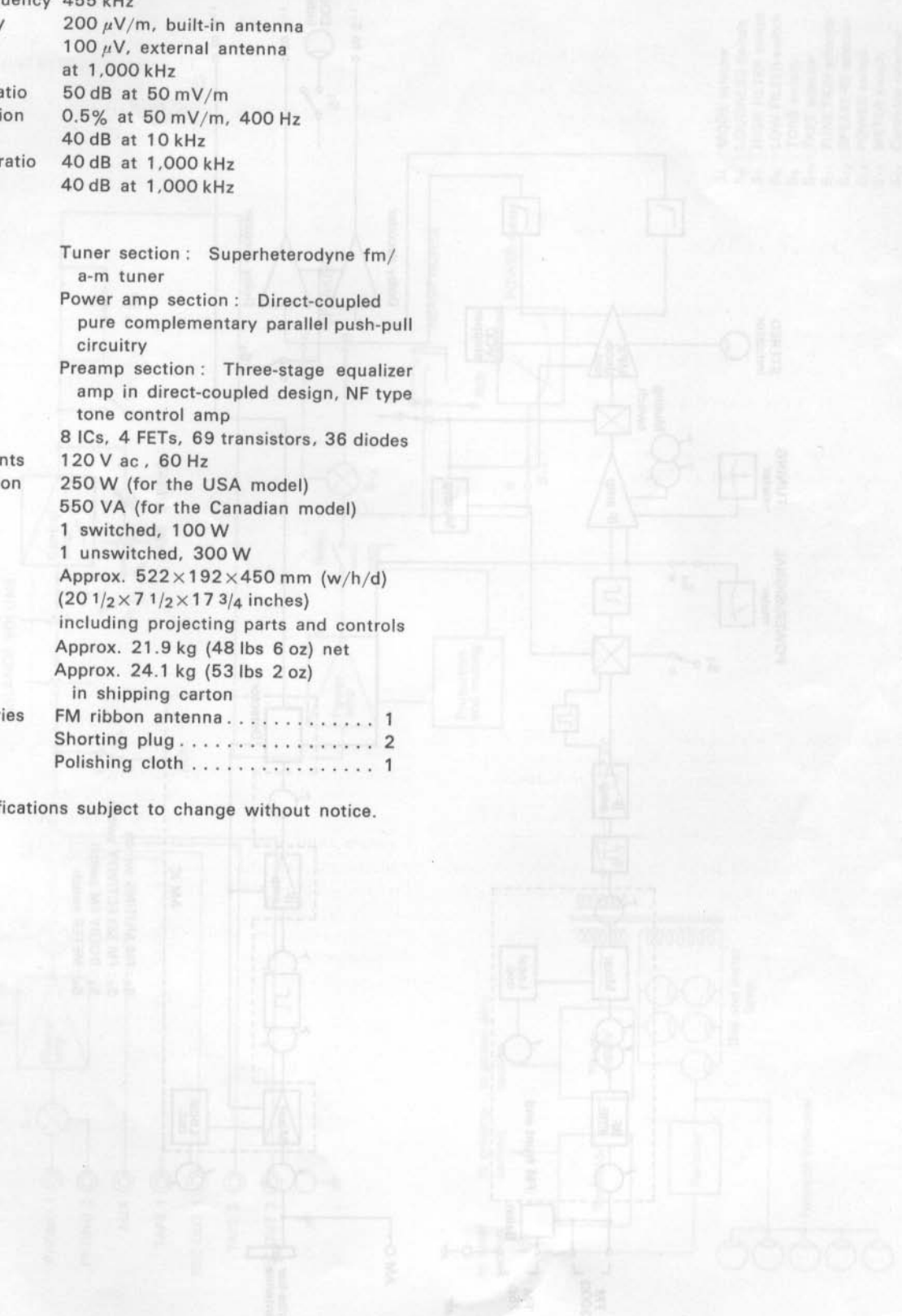

BLOCK DIAGRAM

TUNER SECTION

POWER OUTPUT AND TOTAL HARMONIC DISTORTION
 With 8-ohm loads, both channels driven, with channel minimum 5% error on this level 20-20,000 Hz with 150 watts per channel minimum 0.5% total harmonic distortion 250 milliwatts

OTHER SPECIFICATIONS

Amplifier section
 Tuning range
 Intermediate frequency
 Load impedance
 Frequency response
 Signal-to-noise ratio
 Dynamic range
 Total harmonic distortion
 Power output
 Tuning indicator
 Muting switch
 IF amp
 VCO stopper
 Dolby decoder
 DOLBY FM indicator
 S₁
 S₂
 S₃
 S₄

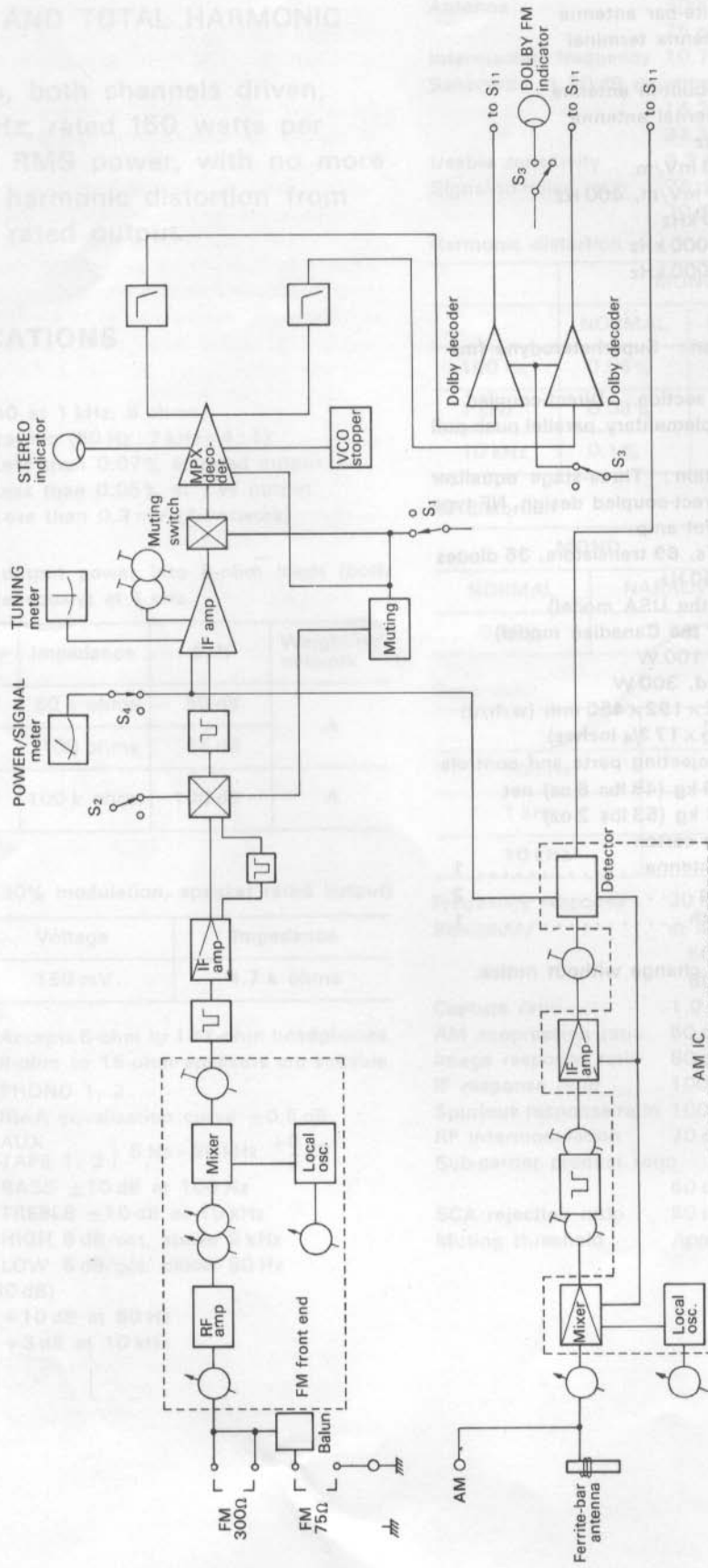

AUDIO SECTION

STEREO FM-AM RECEIVER

STR-V7

- S₅ : MODE selector
- S₆ : LOUDNESS switch
- S₇ : HIGH FILTER switch
- S₈ : LOW FILTER switch
- S₉ : TONE switch
- S₁₀ : TAPE selector
- S₁₁ : FUNCTION selector
- S₁₂ : SPEAKERS selector
- S₁₃ : POWER switch
- S₁₄ : METER switch
- S₁₅ : Cartridge selector

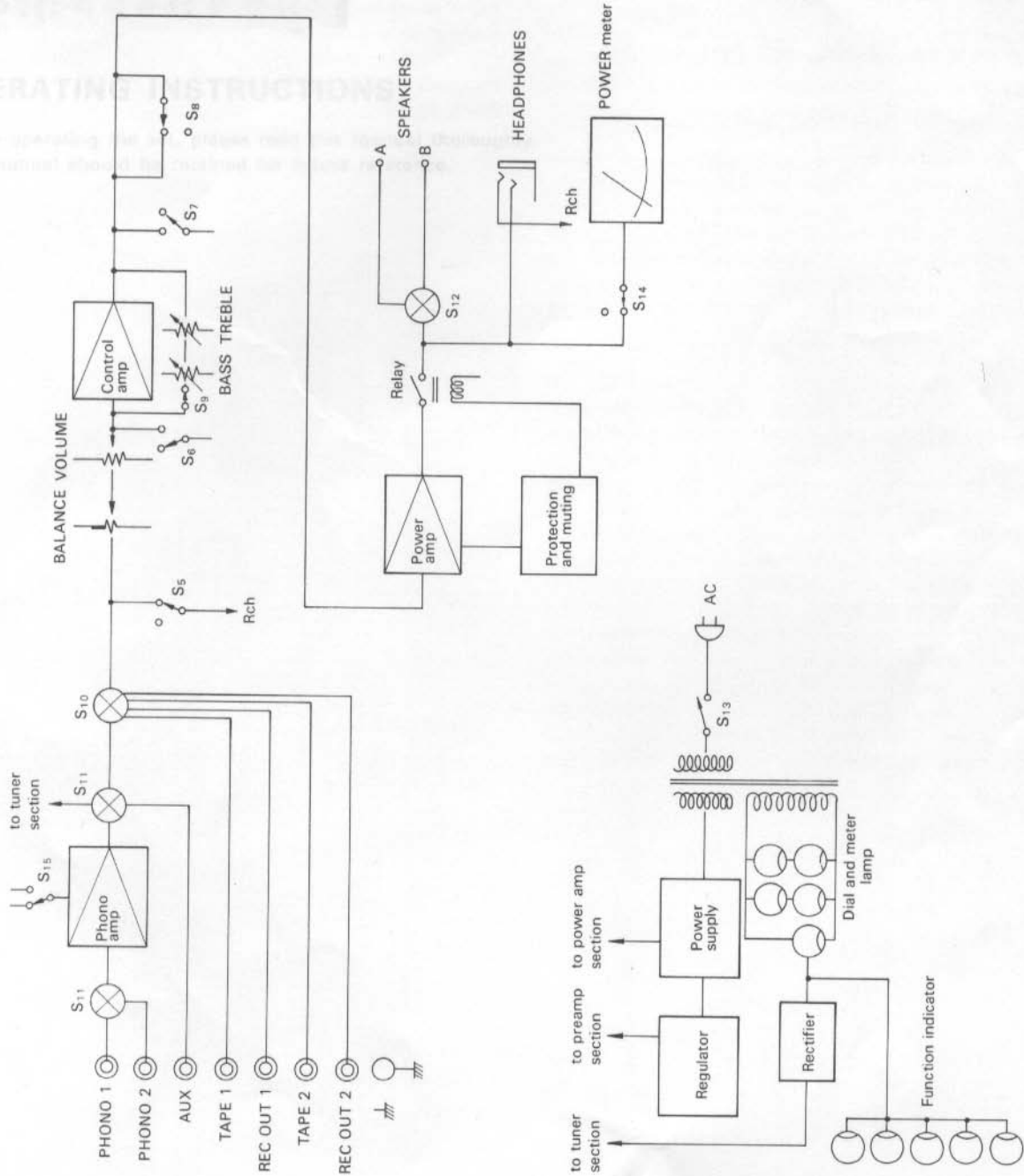

BLOCK DIAGRAM

TUNER SECTION

VIDEO SECTION

- 215 Chroma region
- 216 W-LIN ready
- 217 GAIN/STBY
- 218 S-BYPASS
- 219 S-PROTECT
- 220 S-LOCK
- 221 S-LOCK
- 222 S-LOCK
- 223 S-LOCK
- 224 S-LOCK
- 225 S-LOCK
- 226 S-LOCK
- 227 S-LOCK
- 228 S-LOCK
- 229 S-LOCK
- 230 S-LOCK
- 231 S-LOCK
- 232 S-LOCK
- 233 S-LOCK
- 234 S-LOCK
- 235 S-LOCK
- 236 S-LOCK
- 237 S-LOCK
- 238 S-LOCK
- 239 S-LOCK
- 240 S-LOCK
- 241 S-LOCK
- 242 S-LOCK
- 243 S-LOCK
- 244 S-LOCK
- 245 S-LOCK
- 246 S-LOCK
- 247 S-LOCK
- 248 S-LOCK
- 249 S-LOCK
- 250 S-LOCK
- 251 S-LOCK
- 252 S-LOCK
- 253 S-LOCK
- 254 S-LOCK
- 255 S-LOCK
- 256 S-LOCK
- 257 S-LOCK
- 258 S-LOCK
- 259 S-LOCK
- 260 S-LOCK
- 261 S-LOCK
- 262 S-LOCK
- 263 S-LOCK
- 264 S-LOCK
- 265 S-LOCK
- 266 S-LOCK
- 267 S-LOCK
- 268 S-LOCK
- 269 S-LOCK
- 270 S-LOCK
- 271 S-LOCK
- 272 S-LOCK
- 273 S-LOCK
- 274 S-LOCK
- 275 S-LOCK
- 276 S-LOCK
- 277 S-LOCK
- 278 S-LOCK
- 279 S-LOCK
- 280 S-LOCK
- 281 S-LOCK
- 282 S-LOCK
- 283 S-LOCK
- 284 S-LOCK
- 285 S-LOCK
- 286 S-LOCK
- 287 S-LOCK
- 288 S-LOCK
- 289 S-LOCK
- 290 S-LOCK
- 291 S-LOCK
- 292 S-LOCK
- 293 S-LOCK
- 294 S-LOCK
- 295 S-LOCK
- 296 S-LOCK
- 297 S-LOCK
- 298 S-LOCK
- 299 S-LOCK
- 300 S-LOCK

