

SOLID STATE STEREO PREAMPLIFIER

SC-700

KCL



INSTALLATION, OPERATION AND SERVICE MANUAL

Including PARTS LIST, CIRCUIT DIAGRAM
AND MOUNTING TEMPLATE.

 **PIONEER**[®]

FEATURES

WIDE DYNAMIC RANGE

The SC-700 is a 3-stage amplifier with negative feedback; this assures correct equalization or compliance to the RIAA Standard, and effectively reduces clipping. The result is more natural sound at any volume level.

HEADSET CONVENIENCE

The SC-700 may be monitored with a headset, to check the condition of the system and the tonal quality while making recordings. And a headset, of course, lets you listen in private when this is more convenient. The SC-700 incorporates an individual circuit designed especially for use with a headset for noticeably higher fidelity.

IMPROVED TONE CONTROL SYSTEM

There are numbered "step" controls for both bass and

treble. Their ranges have been determined by Pioneer's long acquaintance with the musical tastes of high fidelity enthusiasts.

MUTING SWITCH

A simple touch of this button instantly lowers the level of sound by at least a half turn of the volume control—handy when the phone suddenly rings, for example.

EASY CARTRIDGE COMPARISON

The two inputs for magnetic cartridge operation allow you to compare and evaluate the tonal quality of different cartridges.

SIMPLIFIED OPERATION

The SC-700 has been carefully designed for stable operation and ease in use.

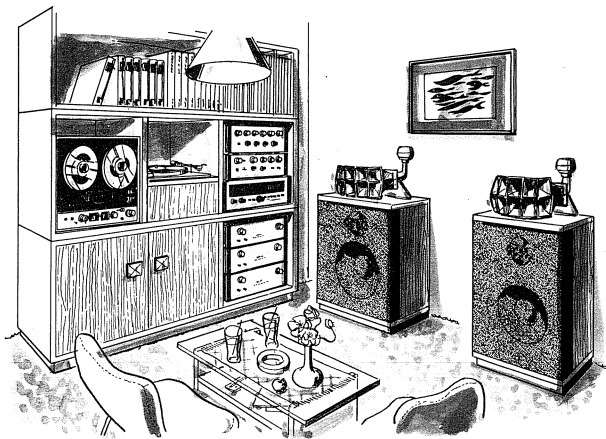

Fig. 1

INSTALLATION

When installing your stereo system, check the following points.

- * The area should be well-ventilated, and free from dampness and dust.
- * The units should not be exposed to direct sunlight.
- * The units should not be placed near radiators or other heating units.
- * The units should be stable, unaffected by vibrations caused by walking about, etc.

STEREO SYSTEM SETUP USING SC-700

The SC-700 is a stereo control amplifier which selects a desired program source among those connected to the SC-700 and provides it to the stereo reproduction system. Typical system setups using the SC-700 are illustrated in Figs. 3, 4 and 5 as shown in these figures, the SC-700 unit may be combined with separately purchased stereo power (basic) amplifier, turntable, tape deck, etc. When combined with the PIONEER IS-70 or IS-80 integrated speaker system, the SC-700 unit can be directly connected to the IS-70 or -80 system.

CONNECTION DIAGRAM

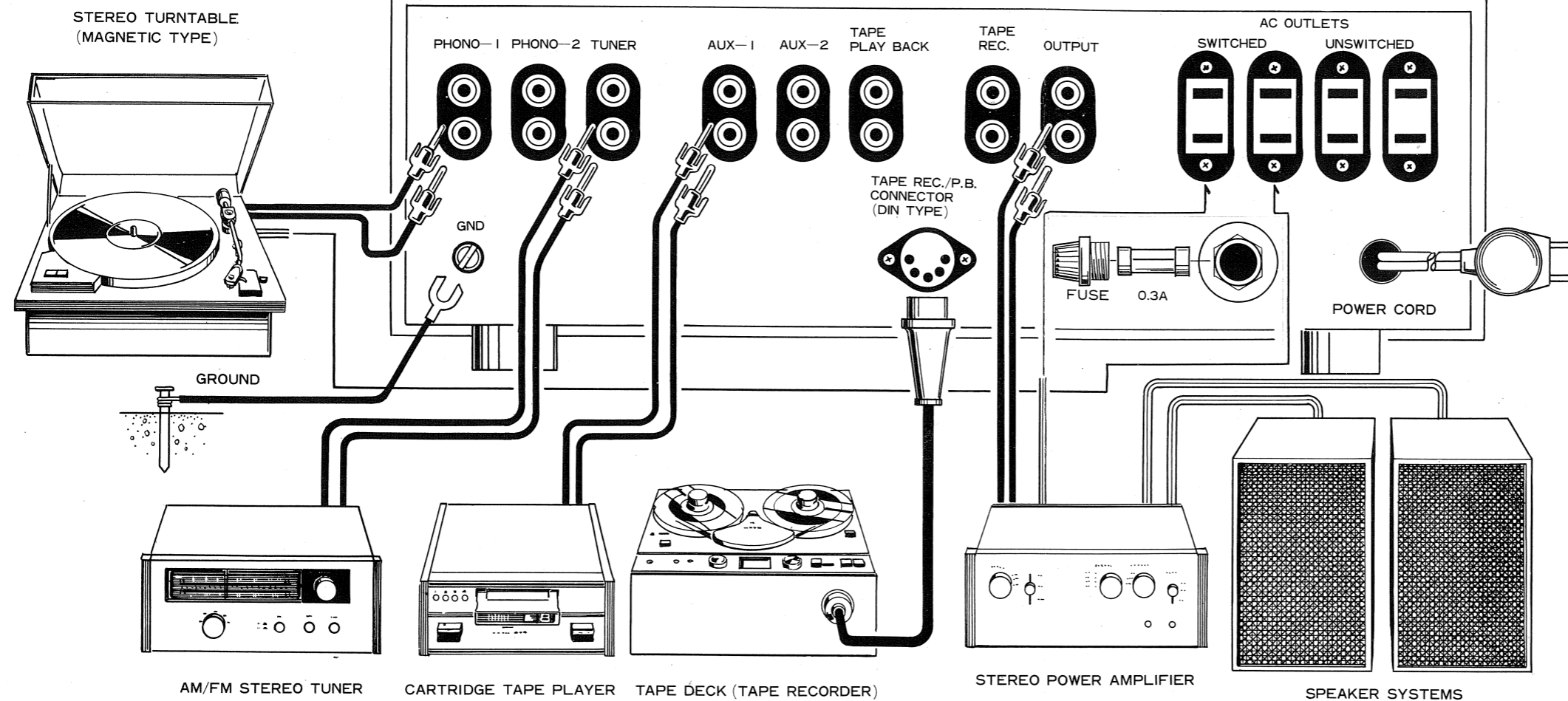

Fig. 2

CONSIDERATION IN SELECTION OF POWER AMPLIFIER

When combined with the PIONEER SM-700 Power amplifier or the integrated speaker system IS-70 or -80, the SC-700 provides an ideal performance. When the unit is to be used with other power amplifiers, the following points must be taken into consideration:

- The input impedance must be higher than 50 kΩ at 1 kHz.
- It is preferable that the input sensitivity be better than 4 volts at 1 kHz.
- Distortion and frequency characteristics must be good.

POWER AMPLIFIER CONNECTION

- Connect the OUTPUT jacks of SC-700 to the input jacks of the power amplifier with good shield wires.
- Since the output impedance of SC-700 is as low as 5 ohms at 1 kHz or lower than that, the output can be extended up to 15 meters (45 feet) with good shielded wires. Note that an output extension beyond 15 meters (45 feet) may result in an unsatisfactory performance.

TURNTABLE CONSIDERATIONS

- The SC-700 can terminate two MAG. cartridge turntable at PHONO 1 and 2 input jacks. Since the input impedance of SC-700 is 50 kΩ/1 kHz, the BASS and TREBLE controls may have to be adjusted for a proper frequency response if a cartridge with any impedance other than 50 kΩ/1 kHz is used.
- If a crystal or ceramic cartridge turntable is to be used, its output leads should be connected to either AUX 1 or AUX 2 input jacks.

TAPE RECORDER CONSIDERATIONS

- The recorder to be connected to the SC-700 must be equipped with LINE INPUT (recording input) and LINE OUTPUT (playback out) jacks.
- If a tape deck is to be connected to the SC-700 it should contain a record/playback amplifier. If a playback-only tape deck is to be used, it should also contain a playback amplifier.

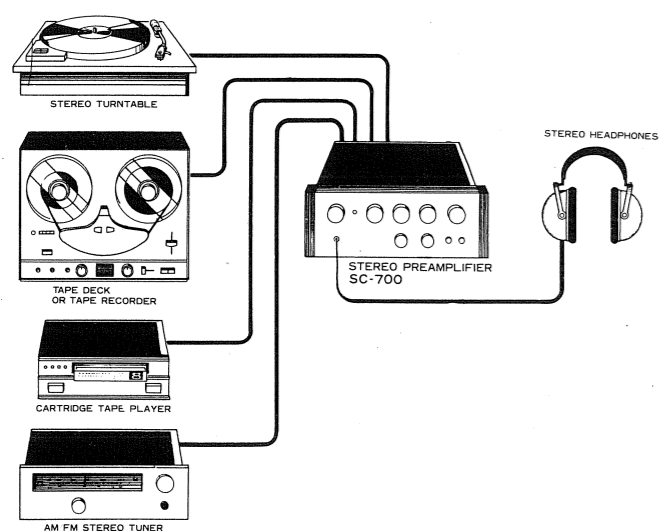

Fig. 3

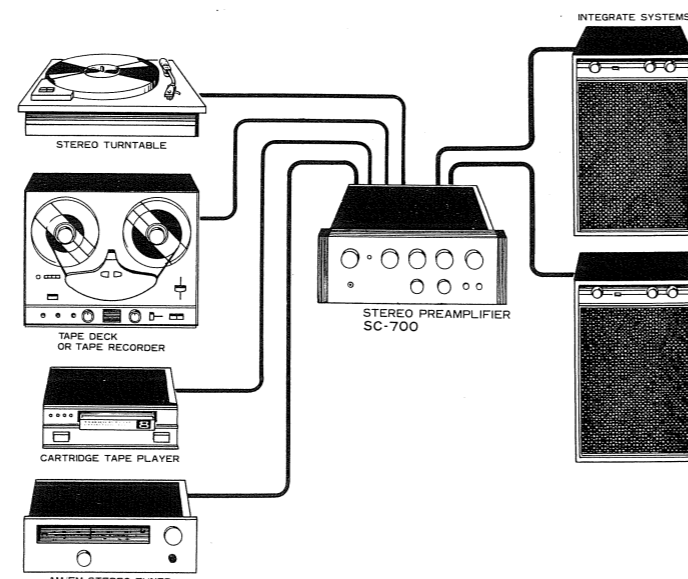

Fig. 4

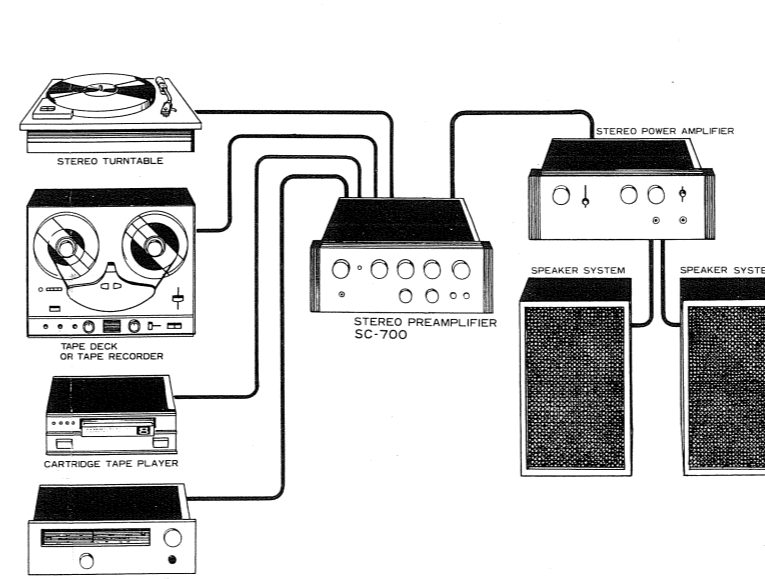
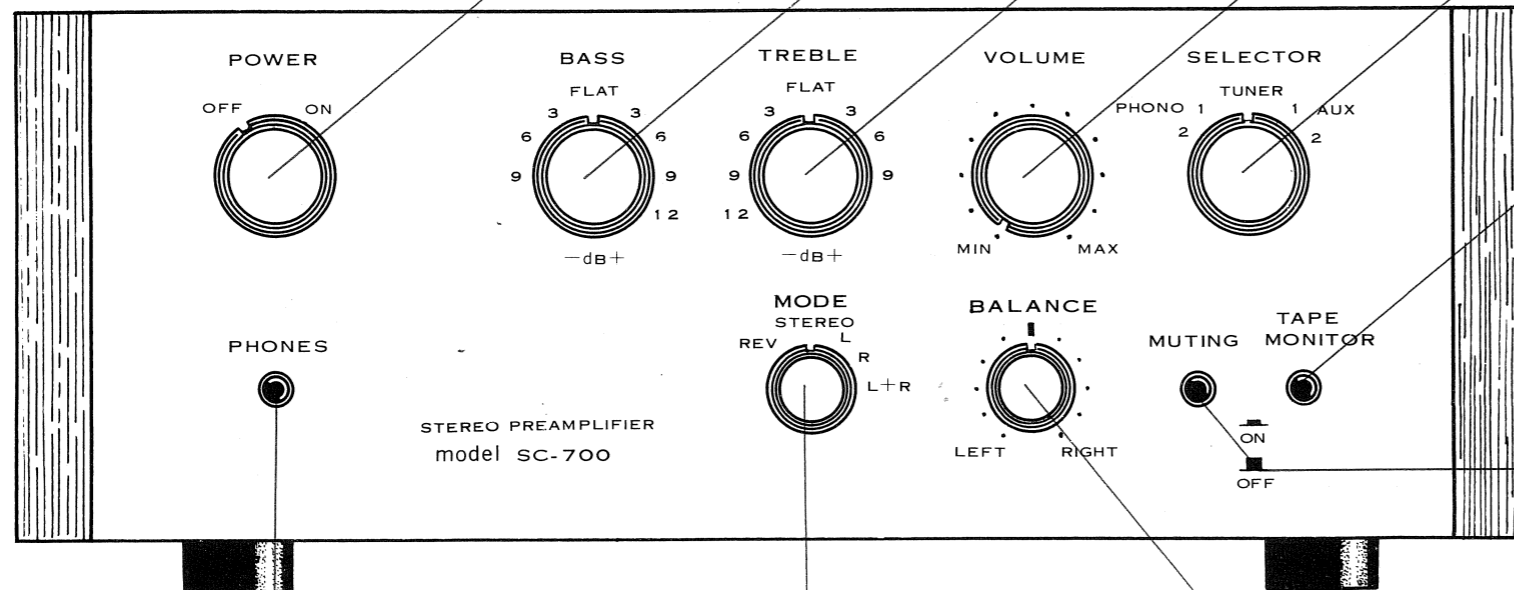

Fig. 5

SWITCHES AND CONTROLS ON FRONT PANEL

Fig. 6



■ POWER SWITCH

Controls power to the unit. Turning it clockwise will apply power to the unit.

■ BASS & TREBLE CONTROLS

Control bass and treble. The figures shown around the control knob indicate the levels in dB. Turning each control clockwise from the FLAT position will enhance the tone, and turning it counterclockwise will attenuate the tone.

■ VOLUME CONTROL

Controls the output volume. Turning it clockwise will increase the volume.

■ SELECTOR SWITCH

Selects input program sources.
 PHONO 1 and 2 - for selecting a magnetic cartridge turntable.
 TUNER - for selecting an FM or AM tuner.
 AUX 1 and 2 - for selecting a crystal or ceramic turntable or a tape cartridge player.

■ TAPE MONITOR SWITCH

Allows you to monitor the program present in the SC-700 when the program is being recorded on a tape recorder or playback from a tape deck (which has a playback amplifier). After the monitoring, be sure to press the TAPE MONITOR button again to restore the output condition to normal; otherwise no output will appear at the OUTPUT jacks of the SC-700.

■ MUTING SWITCH

Attenuates the SC-700 output to 1/10 of the current output level when pressed. Pressing the MUTING button again will restore the output to the original level. This is convenient for muting the stereo system for a while and then to restore it to normal.

■ BALANCE CONTROL

Controls the level balance between the left-channel and the right-channel speaker systems. Turning this control counterclockwise will decrease the sound from the right-channel speaker and turning it clockwise will decrease the sound from the left-channel speaker.

■ PHONES JACK

Accepts the plug of stereo headphones. Connecting the phones plug to this jack will disconnect the output circuit from the OUTPUT jacks on the rear panel of the SC-700.

■ MODE SWITCH

Selects the stereo or mono mode of operations.
 REV—reverses the right and left channel outputs.
 STEREO—provides stereo output to the power amplifier. (For an ordinary stereo operation, the MODE switch should be kept in this position.)
 MONO L—provides only the left channel output to the power amplifier.
 MONO R—provides only the right channel output to the power amplifier.
 MONO L + R—provides a mixed output of the left and right channel signals to the power amplifier.

OPERATING CONSIDERATIONS

TONE CONTROLS

The BASS control can vary the output level at 100 Hz from -9 dB to +12 dB at 3 dB steps, and the TREBLE control, at 10 kHz from -12 dB to +9 dB at 3 dB steps. Since the change of settings of these controls does not affect the response in the middle-frequency range, you can easily obtain a desired tonal quality of reproduced sound.

STEREO HEADPHONES

Connecting the plug of your stereo headphones to the PHONES jack will disconnect the output circuit from the OUTPUT jacks. When the plug is connected to or disconnected from the PHONES jack while the stereo system is in use, audible "clicks" may be made from the speakers, depending on the type of the power amplifier used. If so, connect a 100kΩ resistor between the input jack of the power amplifier and the ground to eliminate the click.

MODE SWITCH

The MODE switch has five positions to select. The relation between the input and the output at each position is illustrated below:

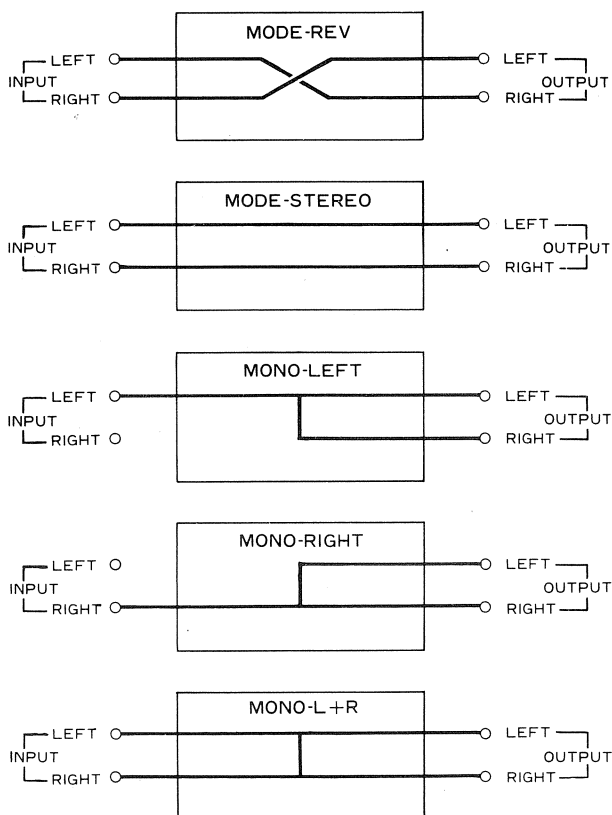

Fig. 7

MUTING SWITCH

When you desire to reduce the volume for some reason while a program is being reproduced, press the MUTING button as far as it will lock in the ON position; then, the volume will be reduced to 1/10 of the output level. Pressing the button again will restore the volume to the original level. In other words, you can reduce the volume by the one fingertip operation without turning the VOLUME control.

Another application of this switch is to change the control range of the VOLUME control from 0V ~ 4V to 0V ~ 0.4V by pressing the MUTING button into ON. This is convenient when the input sensitivity of the power amplifier is extremely high.

TAPE MONITOR SWITCH

If your tape recorder is equipped with separate erase, record, and playback heads and contain the recording preamplifier and playback equalizer, a complete tape monitoring is made possible by connecting the tape recorder to the SC-700 as illustrated below. Pressing the MONITOR switch to ON will extend the signal after recording, to the SC-700 unit through the playback head and allow you to monitor the signal from the speakers. Pressing the MONITOR switch again will restore the switch to the OFF position and, in this instance, allow you to monitor the sound before recording. Therefore, by pressing the MONITOR switch on and off repeatedly, you can assure yourself that the program is being recorded on tape properly.

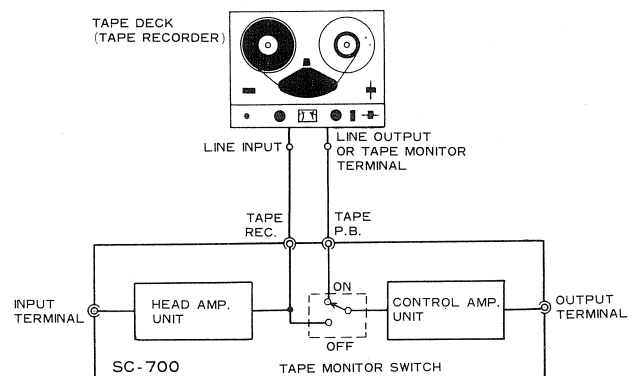

Fig. 8

SPECIFICATIONS

SEMICONDUCTORS

EETs.....	2
Transistors.....	14
Diodes.....	3

AUDIO SECTION

Maximum Output Voltage	4V rms/less than 0.5% H.D. at 1kHz
Harmonic Distortion	Less than 0.05% at 2V
Frequency Response	10Hz to 60kHz \pm 1dB (input terminal AUX)
Signal to Noise Ratio	PHONO more than 80dB at 4V, IHF AUX more than 100dB at 4V, IHF
Sensitivity and Impedance of INPUT terminals (at 1kHz 4V output)	PHONO 1,2 4 mV, 50k Ω AUX 1,2 250 mV, 220k Ω TUNER 250 mV, 220k Ω
Equalization	NFB type RIAA
Bass Control	+12dB, -9dB at 100Hz (3dB steps)
Treble Control	+9dB, -12dB at 10kHz (3dB steps)
MUTING	-20dB, switchable to ON-OFF
OUTPUT Jacks and Terminals	Output (Output Impedance less than 5 Ω at 1kHz) Load Impedance More than 20k Ω Stereo Headphone Jack (used for 8 Ω to 16 Ω) TAPE REC/P.B. Connector (DIN type)
MISCELLANEOUS	
Power Requirements	120 volts
Power Consumption	5 VA
Dimensions	11 13/16" /300mm (width) 4 1/2" /115mm (height) 10" /254mm (depth)
Weight	Without package 9 lb/4.1kg With package 13 lb/5.9kg

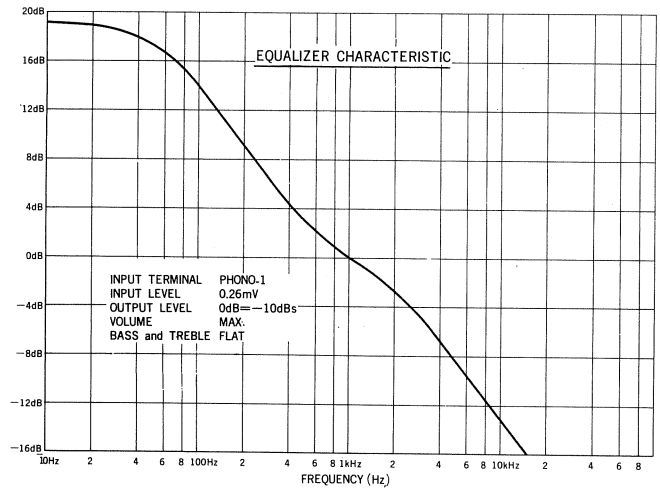
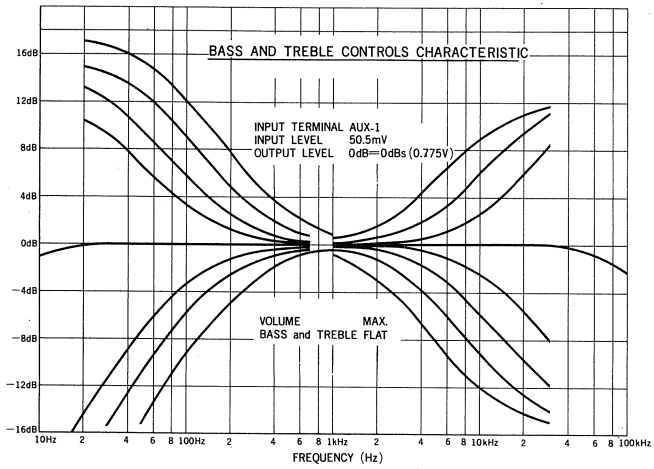
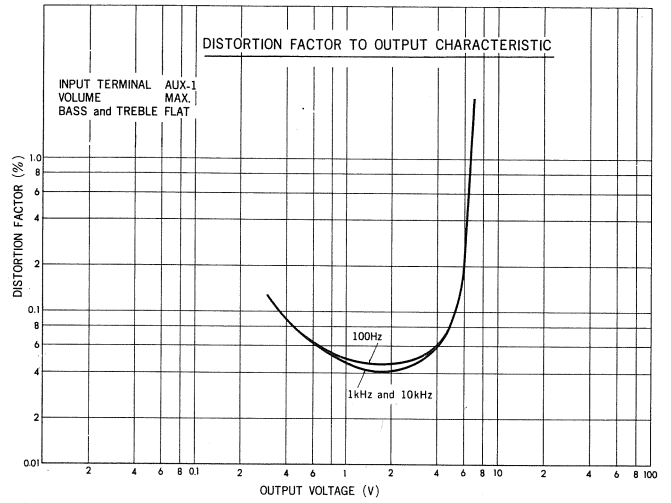
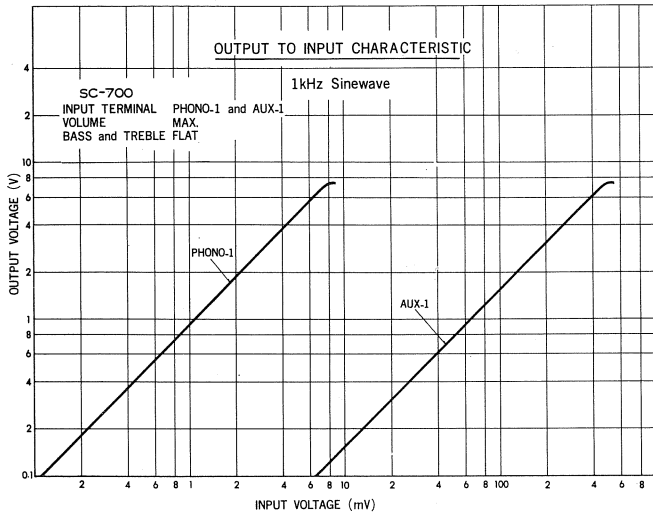

SCHEMATIC CIRCUIT
DIAGRAM

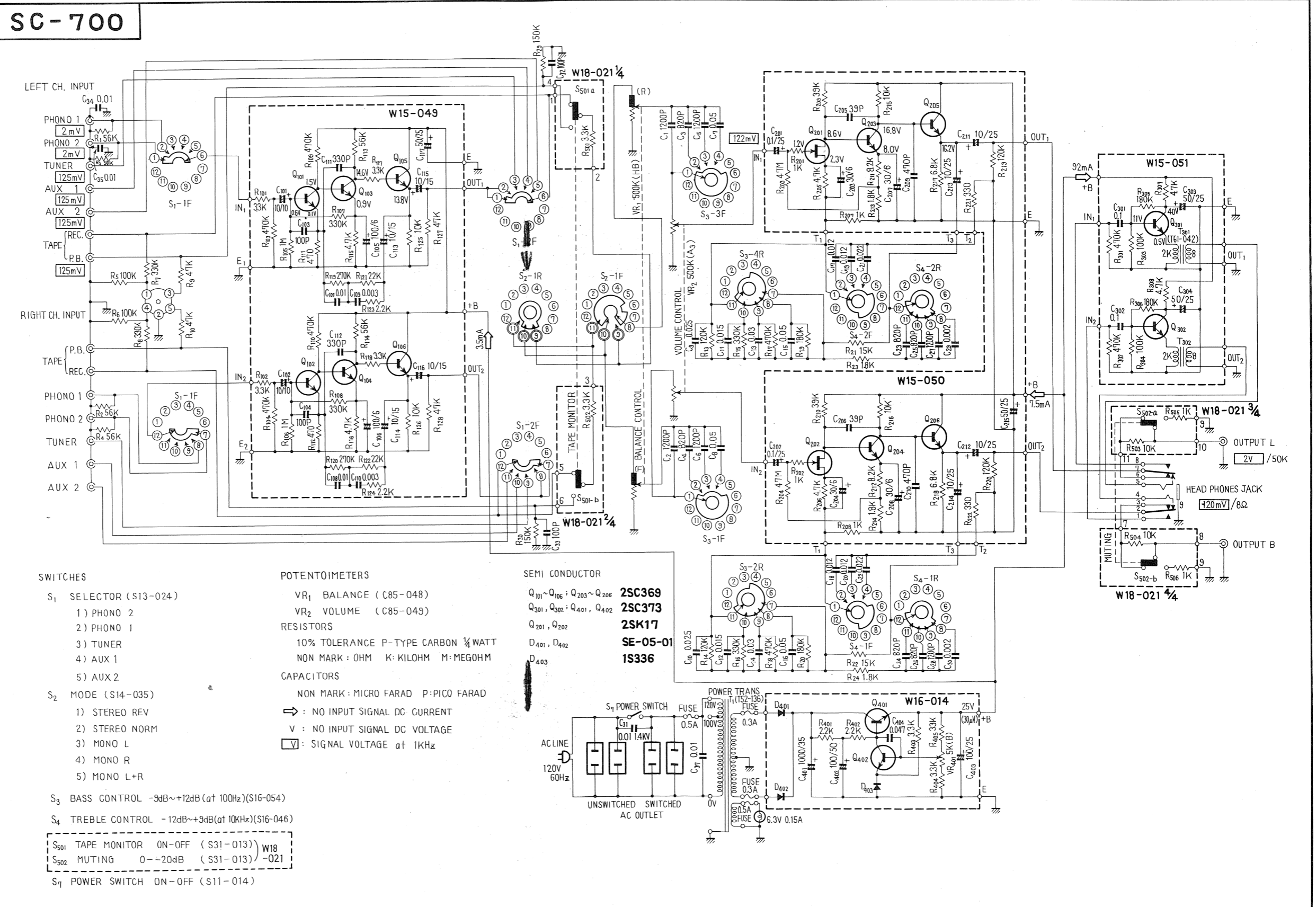

PARTS LIST

CAPACITORS

IN μ F, 10% TOLERANCE UNLESS OTHERWISE NOTED
p : μ F

Symbol	Description	Part No.
C1	Styrol 1200p 50V	CQSA 122K 50
C2	Styrol 1200p 50V	CQSA 122K 50
C3	Styrol 820p 50V	CQSA 821K 50
C4	Styrol 820p 50V	CQSA 821K 50
C5	Styrol 1200p 50V	CQSA 122K 50
C6	Styrol 1200p 50V	CQSA 122K 50
C7	Mylar 0.05 50V	CQMA 503K 50
C8	Mylar 0.05 50V	CQMA 503K 50
C9	Mylar 0.025 50V	CQMA 253K 50
C10	Mylar 0.025 50V	CQMA 253K 50
C11	Mylar 0.015 50V	CQMA 153K 50
C12	Mylar 0.015 50V	CQMA 153K 50
C13	Mylar 0.03 50V	CQMA 303K 50
C14	Mylar 0.03 50V	CQMA 303K 50
C15	Mylar 0.05 50V	CQMA 503K 50
C16	Mylar 0.05 50V	CQMA 503K 50
C17	Mylar 0.012 50V	CQMA 123K 50
C18	Mylar 0.012 50V	CQMA 123K 50
C19	Mylar 0.012 50V	CQMA 123K 50
C20	Mylar 0.012 50V	CQMA 123K 50
C21	Mylar 0.022 50V	CQMA 223K 50
C22	Mylar 0.022 50V	CQMA 223K 50
C23	Styrol 820p 50V	CQSA 821K 50
C24	Styrol 820p 50V	CQSA 821K 50
C25	Styrol 820p 50V	CQSA 821K 50
C26	Styrol 820p 50V	CQSA 821K 50
C27	Styrol 1200p 50V	CQSA 122K 50
C28	Styrol 1200p 50V	CQSA 122K 50
C29	Mylar 0.002 50V	CQMA 202K 50
C30	Mylar 0.002 50V	CQMA 202K 50
C31	Ceramic 0.01 DC1.4 kV	C43-003-0
C32	Ceramic 100p 50V	CCDSL 101K 50
C33	Ceramic 100p 50V	CCDSL 101K 50
C34	Ceramic 0.01	CKDYZ 103Z50
C35	Ceramic 0.01 50V	CKDYZ 103Z 50
C36	Ceramic 0.01 50V	CKDYZ 103Z50
C37	Oil paper 0.01 450V	C15-001-0

RESISTORS

IN Ω , 10% TOLERANCE $\frac{1}{4}$ W UNLESS OTHERWISE NOTED
k : k Ω , M : M Ω

Symbol	Description	Part No.
R1	Carbon film 56K	RF $\frac{1}{4}$ PS 56K-K
R2	Carbon film 56K	RF $\frac{1}{4}$ PS 56K-K
R3	Carbon film 56K	RF $\frac{1}{4}$ PS 56K-K
R4	Carbon film 56K	RF $\frac{1}{4}$ PS 56K-K
R5	Carbon film 100K	RF $\frac{1}{4}$ PS 100K-K

R6	Carbon film 100K	RF $\frac{1}{4}$ PS 100K-K
R7	Carbon film 330K	RF $\frac{1}{4}$ PS 330K-K
R8	Carbon film 330K	RF $\frac{1}{4}$ PS 330K-K
R9	Carbon film 47K	RF $\frac{1}{4}$ PS 47K-K
R10	Carbon film 47K	RF $\frac{1}{4}$ PS 47K-K
R13	Carbon film 120K	RF $\frac{1}{4}$ PS 120K-K
R14	Carbon film 120K	RF $\frac{1}{4}$ PS 120K-K
R15	Carbon film 330K	RF $\frac{1}{4}$ PS 330K-K
R16	Carbon film 330K	RF $\frac{1}{4}$ PS 330K-K
R17	Carbon film 470K	RF $\frac{1}{4}$ PS 470K-K
R18	Carbon film 470K	RF $\frac{1}{4}$ PS 470K-K
R19	Carbon film 180K	RF $\frac{1}{4}$ PS 180K-K
R20	Carbon film 180K	RF $\frac{1}{4}$ PS 180K-K
R21	Carbon film 15K	RF $\frac{1}{4}$ PS 15K-K
R22	Carbon film 15K	RF $\frac{1}{4}$ PS 15K-K
R23	Carbon film 1.8K	RF $\frac{1}{4}$ PS 1R8K-K
R24	Carbon film 1.8K	RF $\frac{1}{4}$ PS 1R8K-K
R29	Carbon film 150K	RF $\frac{1}{4}$ PS 150K-K
R30	Carbon film 150K	RF $\frac{1}{4}$ PS 150K-K

SWITCHES

Symbol	Description	Part No.
S1	SELECTOR	S13-024-0
S2	MODE	S14-035-0
S3	BASS	S16-046-0
S4	TREBLE	S16-054-0
S7	POWER	S11-014-A

TRANSFORMER

Symbol	Description	Part No.
	Power Transformer	T52-136-0

POTENTIOMETERS

Symbol	Description	Part No.
VR1	500k Ω dual, Balance Control	C85-048-B
VR2	500k Ω dual, Volume Control	C85-049-B

MISCELLANEOUS

Symbol	Description	Part No.
	Head Amp Unit	W15-049-0
	Control Amp Unit	W15-050-A
	Headphone Amp Unit	W15-051-A
	Power Supply Unit	W16-014-0
	Push Switch Unit	W18-021-0
	Front Panel	M21-377-0
	Metal Cover	M33-112-0
	Knob for Power Switch, Bass, Treble, Volume and Selector	A12-120-A
	Knob for Mode and Balance	A12-141-A
	Lens for Pilot lamp	A62-045-0
	4p Input Terminal	K21-010-D
	6p Input Terminal	K22-013-C
	Headphone Jack	K72-020-0
	5p Connector (Din type)	K93-003-B
	Spare AC Outlet	K82-011-0
	Pilot lamp Socket	K42-002-B
	Fuse Holder	K96-007-A
	Fuse 0.5A	E21-028-0
	Fuse 0.3A	E22-032-0
	Foot	M61-017-0

HEAD AMP UNIT (W15-049)

CAPACITORS

Symbol	Description	Part No.
C101	Electrolytic 10 10V	CEMX 10MF 10V
C102	Electrolytic 10 10V	CEMX 10MF 10V
C103	Ceramic 100p 50V	CCDSL 101K 50
C104	Ceramic 100p 50V	CCDSL 101K 50
C105	Electrolytic 100 6V	CEMX 100MF 6V
C106	Electrolytic 100 6V	CEMX 100MF 6V
C107	Mylar 0.01 50V	CQMA 103K 50
C108	Mylar 0.01 50V	CQMA 103K 50
C109	Mylar 3000p 50V	CQMA 302K 50
C110	Mylar 3000p 50V	CQMA 302K 50
C111	Ceramic 330p 50V	CCDSL 331K 50
C112	Ceramic 330p 50V	CCDSL 331K 50
C113	Electrolytic 10 15V	CEMX 10MF 15V
C114	Electrolytic 10 15V	CEMX 10MF 15V
C115	Electrolytic 10 15V	CEMX 10MF 15V
C116	Electrolytic 10 15V	CEMX 10MF 15V
C117	Electrolytic 50 25V	CEMX 50MF 25V

RESISTORS

Symbol	Description	Part No.
R101	Carbon film 3.3K	RF $\frac{1}{4}$ PS 3R3K-K
R102	Carbon film 3.3K	RF $\frac{1}{4}$ PS 3R3K-K
R103	Carbon film 470K	RF $\frac{1}{4}$ PS 470K-K
R104	Carbon film 470K	RF $\frac{1}{4}$ PS 470K-K
R105	Carbon film 1M	RF $\frac{1}{4}$ PS 1M-K
R106	Carbon film 1M	RF $\frac{1}{4}$ PS 1M-K
R107	Carbon film 330K	RF $\frac{1}{4}$ PS 330K-K
R108	Carbon film 330K	RF $\frac{1}{4}$ PS 330K-K
R109	Carbon film 470K	RF $\frac{1}{4}$ PS 470K-K
R110	Carbon film 470K	RF $\frac{1}{4}$ PS 470K-K
R111	Carbon film 470K	RF $\frac{1}{4}$ PS 470K-K
R112	Carbon film 470K	RF $\frac{1}{4}$ PS 470K-K
R113	Carbon film 56K	RF $\frac{1}{4}$ PS 56K-K
R114	Carbon film 56K	RF $\frac{1}{4}$ PS 56K-K
R115	Carbon film 4.7K	RF $\frac{1}{4}$ PS 4R7K-K
R116	Carbon film 4.7K	RF $\frac{1}{4}$ PS 4R7K-K
R117	Carbon film 3.3K	RF $\frac{1}{4}$ PS 3R3K-K
R118	Carbon film 3.3K	RF $\frac{1}{4}$ PS 3R3K-K
R119	Carbon film 270K	RF $\frac{1}{4}$ PS 270K-K
R120	Carbon film 270K	RF $\frac{1}{4}$ PS 270K-K
R121	Carbon film 22K	RF $\frac{1}{4}$ PS 22K-K
R122	Carbon film 22K	RF $\frac{1}{4}$ PS 22K-K
R123	Carbon film 2.2K	RF $\frac{1}{4}$ PS 2R2K-K
R124	Carbon film 2.2K	RF $\frac{1}{4}$ PS 2R2K-K
R125	Carbon film 10K	RF $\frac{1}{4}$ PS 10K-K
R126	Carbon film 10K	RF $\frac{1}{4}$ PS 10K-K
R127	Carbon film 47K	RF $\frac{1}{4}$ PS 47K-K
R128	Carbon film 47K	RF $\frac{1}{4}$ PS 47K-K

TRANSISTORS

Symbol	Description	Part No.
Q101	2SC458LG C or B,2SC871-E,F Transistor	
Q102	2SC458LG C or B,2SC871-E,F Transistor	
Q103	2SC458LG C or B,2SC871-E,F Transistor	
Q104	2SC458LG C or B,2SC871-E,F Transistor	
Q105	2SC458LG C or B,2SC871-E,F Transistor	
Q106	2SC458LG C or B,2SC871-E,F Transistor	

CONTROL AMP UNIT (W15-050)

CAPACITORS

Symbol	Description	Part No.
C201	Electrolytic 0.1 25V	CSYA R10MF 25V
C202	Electrolytic 0.1 25V	CSYA R10MF 25V
C203	Electrolytic 30 6V	CEMX 30MF 6V
C204	Electrolytic 30 6V	CEMX 30MF 6V
C205	Ceramic 39p 50V	CCDSL 390K 50
C206	Ceramic 39p 50V	CCDSL 390K 50
C207	Electrolytic 30 6V	CEMX 30MF 6V
C208	Electrolytic 30 6V	CEMX 30MF 6V
C209	Ceramic 470p 50V	CCDSL 471K 50
C210	Ceramic 470p 50V	CCDSL 471K 50
C211	Electrolytic 10 25V	CEMX 10MF 25V
C212	Electrolytic 10 25V	CEMX 10MF 25V
C213	Electrolytic 10 25V	CEMX 10MF 25V
C214	Electrolytic 10 25V	CEMX 10MF 25V
C215	Electrolytic 50 25V	CEMX 50MF 25V

RESISTORS

Symbol	Description	Part No.
R201	Carbon film 1K	RF½PS 1K-K
R202	Carbon film 1K	RF½PS 1K-K
R203	Carbon film 4.7M	RF½PS 4R7M-K
R204	Carbon film 4.7M	RF½PS 4R7M-K
R205	Carbon film 4.7K	RF½PS 4R7K-K
R206	Carbon film 4.7K	RF½PS 4R7K-K
R207	Carbon film 1K	RF½PS 1K-K
R208	Carbon film 1K	RF½PS 1K-K
R209	Carbon film 39K	RF½PS 39K-K
R210	Carbon film 39K	RF½PS 39K-K
R211	Carbon film 8.2K	RF½PS 8R2K-K
R212	Carbon film 8.2K	RF½PS 8R2K-K
R213	Carbon film 1.8K	RF½PS 1R8K-K
R214	Carbon film 1.8K	RF½PS 1R8K-K
R215	Carbon film 10K	RF½PS 10K-K
R216	Carbon film 10K	RF½PS 10K-K
R217	Carbon film 6.8K	RF½PS 6R8K-K
R218	Carbon film 6.8K	RF½PS 6R8K-K
R219	Carbon film 120K	RF½PS 120K-K
R220	Carbon film 120K	RF½PS 120K-K
R221	Carbon film 330	RF½PS 330-K
R222	Carbon film 330	RF½PS 330-K

TRANSISTOR

Symbol	Description	Part No.
Q201	2SK17-Y FET	
Q202	2SK17-Y FET	
Q203	2SC369-GR Transistor	
Q204	2SC369-GR Transistor	
Q205	2SC369-GR Transistor	
Q206	2SC369-GR Transistor	

HEADPHONE AMP UNIT (W15-051)

CAPACITORS

Symbol	Description	Part No.
C301	Mylar 0.1 50V	CQMA 104K 50
C302	Mylar 0.1 50V	CQMA 104K 50
C303	Electrolytic 50 25V	CEMX 50MF 25V
C304	Electrolytic 50 25V	CEMX 50MF 25V

RESISTORS

Symbol	Description	Part No.
R301	Carbon film 470K	RF½PS 470K-K
R302	Carbon film 470K	RF½PS 470K-K
R303	Carbon film 100K	RF½PS 100K-K
R304	Carbon film 100K	RF½PS 100K-K
R305	Carbon film 180K	RF½PS 180K-K
R306	Carbon film 180K	RF½PS 180K-K
R307	Carbon film 4.7K	RF½PS 4R7K-K
R308	Carbon film 4.7K	RF½PS 4R7K-K

TRANSISTORS

Symbol	Description	Part No.
Q301	2SC373 Transistor	
Q302	2SC373 Transistor	

TRANSFORMERS

Symbol	Description	Part No.
T301	Matching Transformer	T61-042-D
T302	Matching Transformer	T61-042-D

POWER SUPPLY UNIT (W16-014)

CAPACITORS

Symbol	Description	Part No.
C401	Electrolytic 1000 35V	CETG 1000MF 35V
C402	Electrolytic 100 50V	CEMX 100MF 50V
C403	Electrolytic 100 25V	CEMX 100MF 25V
C404	Ceramic 0.047 +100% -0 50V	CKDYZ 473P 50

RESISTORS

Symbol	Description	Part No.
R401	Carbon film 2.2K	RF½PS 2R2K-K
R402	Carbon film 2.2K	RF½PS 2R2K-K
R403	Carbon film 3.3K	RF½PS 3R3K-K
R404	Carbon film 3.3K	RF½PS 3R3K-K
R405	Carbon film 3.3K	RF½PS 3R3K-K

DIODES AND TRANSISTORS

Symbol	Description	Part No.
D401	SE-05-01 Diode	
D402	SE-05-01 Diode	
D403	1S336 Zener Diode	
Q401	2SC373 Transistor	
Q402	2SC373 Transistor	

POTENTIOMETER

Symbol	Description	Part No.
VR401	5 KΩ Semi-fixed	C92-016-0

PUSH SWITCH UNIT (W18-021)

RESISTORS

Symbol	Description	Part No.
R501	Carbon film 3.3K	RF½PS 3R3K-K
R502	Carbon film 3.3K	RF½PS 3R3K-K
R503	Carbon film 10K	RF½PS 10K-K
R504	Carbon film 10K	RF½PS 10K-K
R505	Carbon film 1K	RF½PS 1K-K
R506	Carbon film 1K	RF½PS 1K-K

SWITCHES

Symbol	Description	Part No.
S501	Tape Monitor Switch (Push Type)	S31-022-0
S502	Muting Switch (Push Type)	S31-022-0

OTHERS

Symbol	Description	Part No.
	Knob for Tape Monitor and Muting Switch	A19-081-0

PARTS LAYOUT

Top View

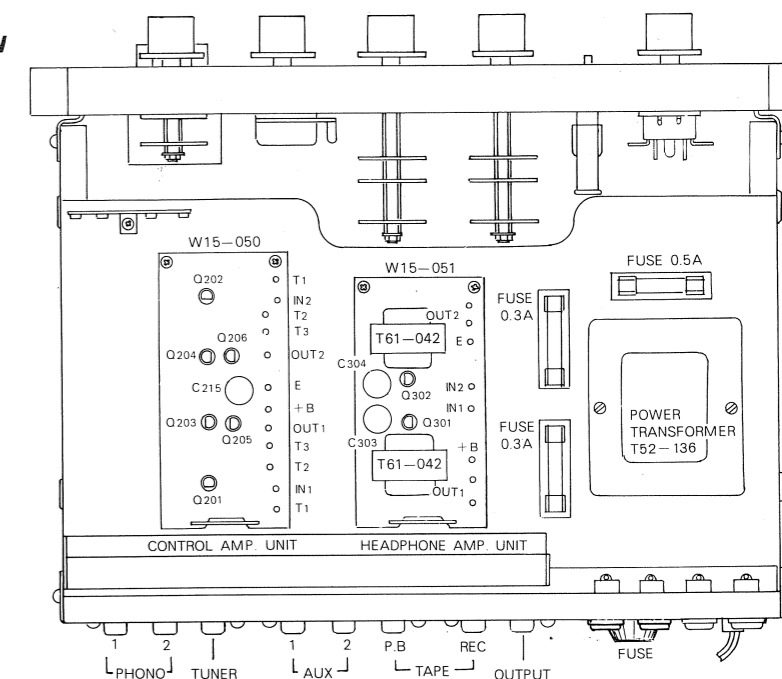

Bottom View

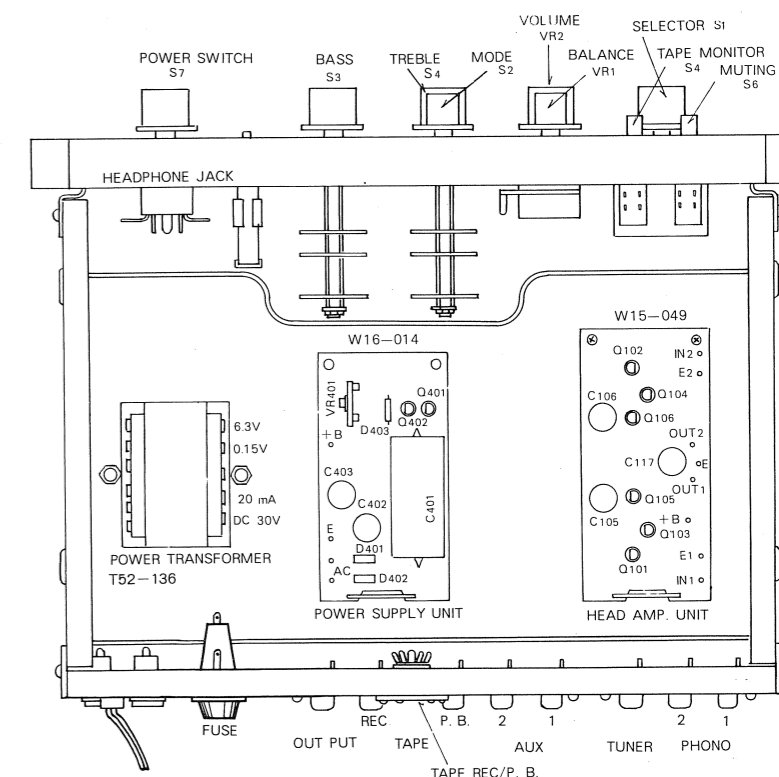

PRINTED CIRCUIT BOARDS

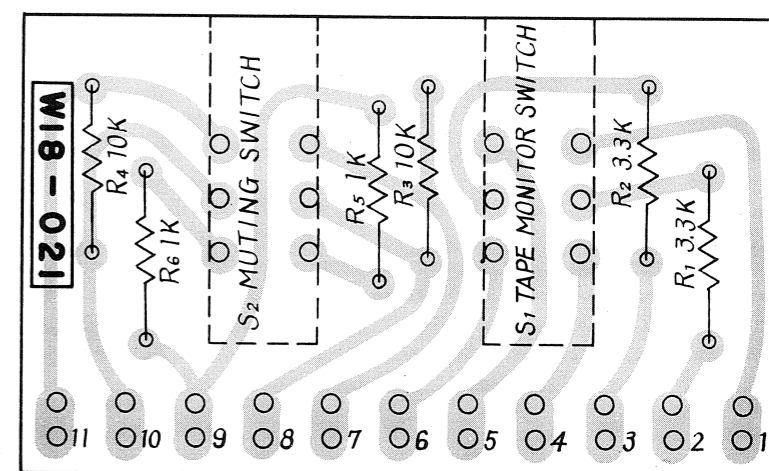
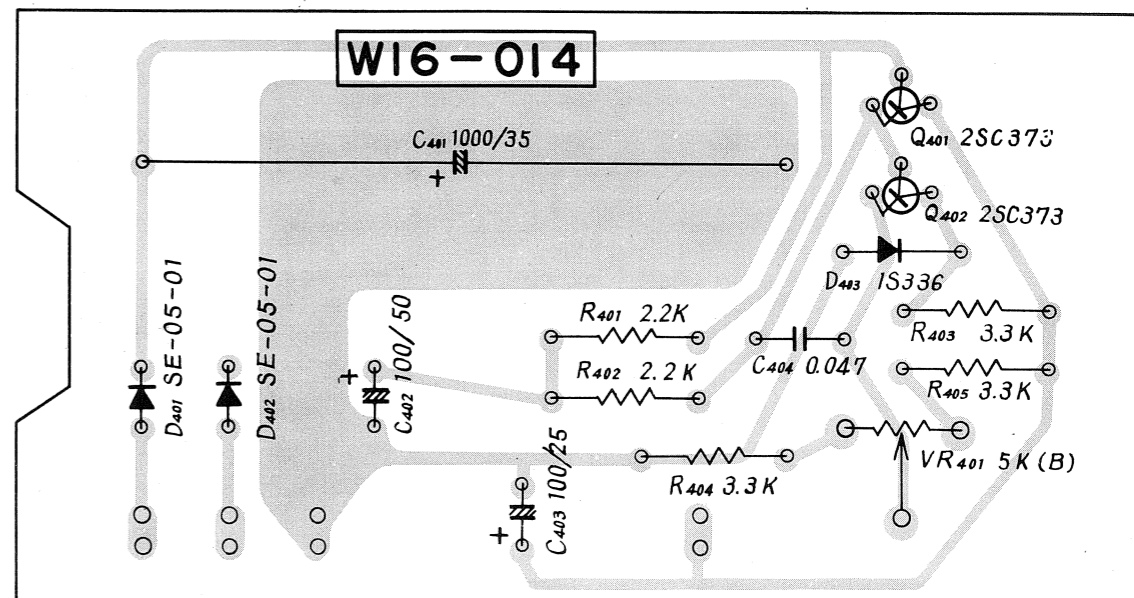
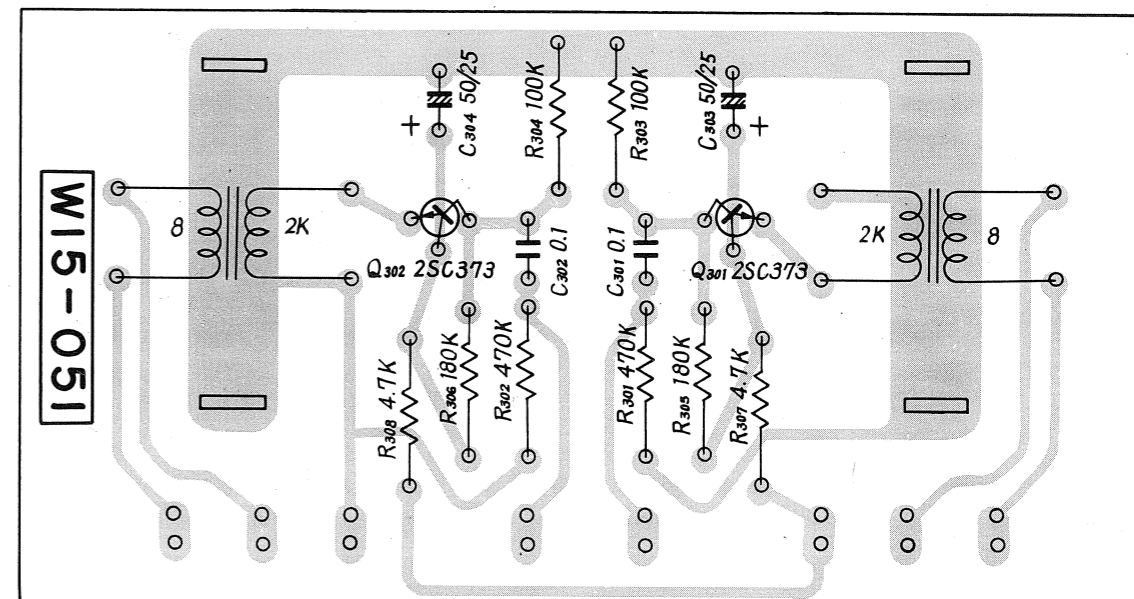
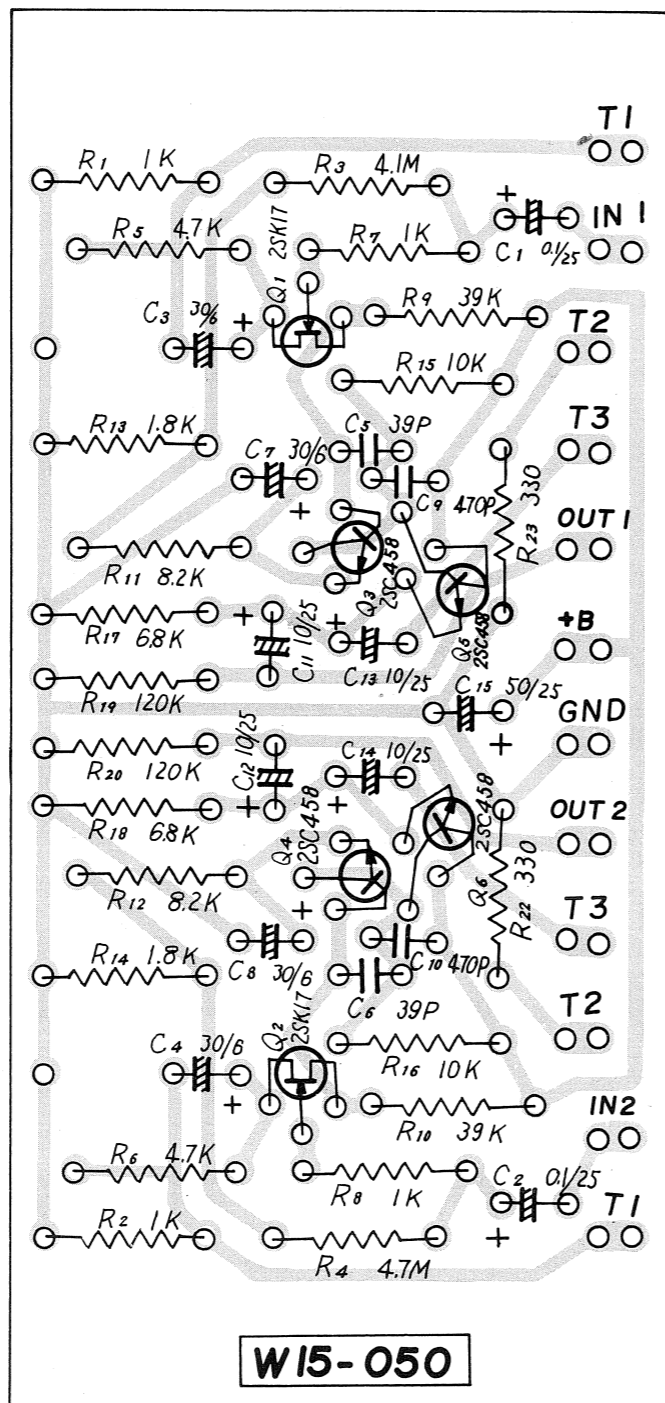
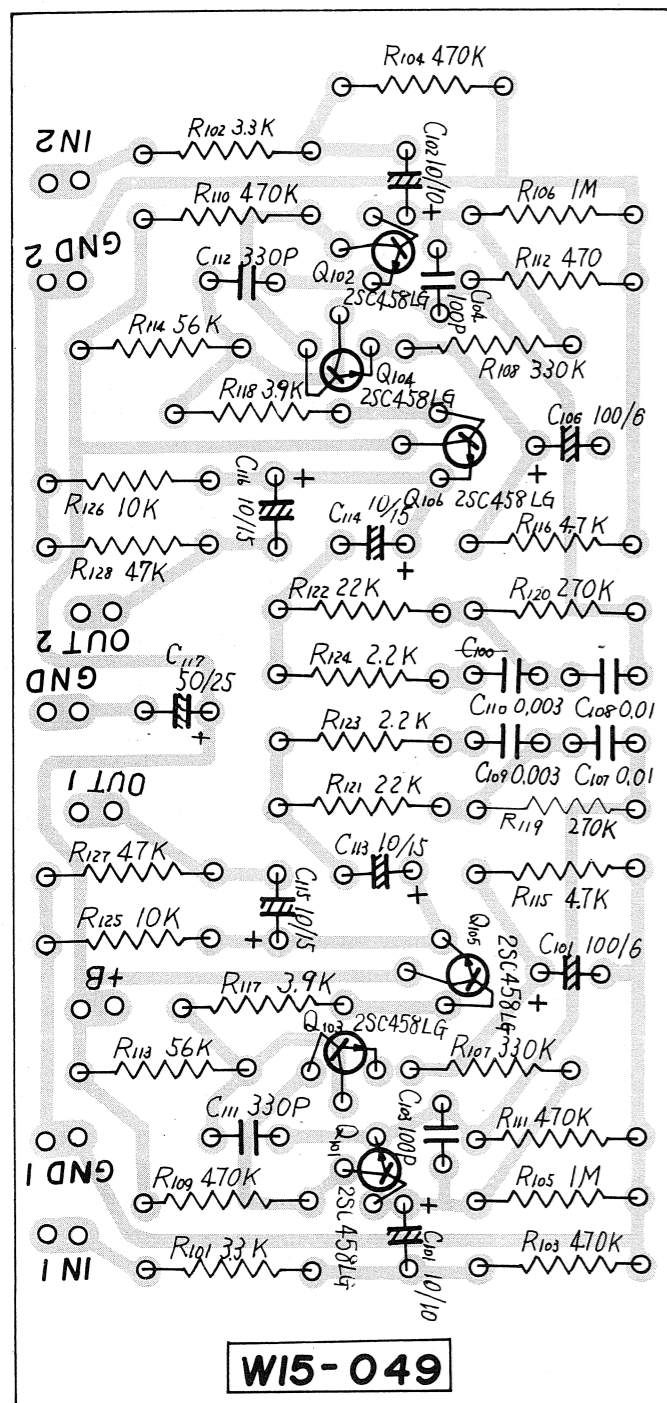

PIONEER ELECTRONIC CORPORATION

15-5, 4-Chome, Ohmori-nishi, Ohta-ku, Tokyo, Japan

PIONEER ELECTRONICS U.S.A. CORPORATION

140 Smith St., Farmingdale, LI., N.Y. 11735, U.S.A.

PIONEER ELECTRONIC (EUROPE) NV

Frankrijklei 64-68, 2000 Antwerp, Belgium