

CONTENTS

- SWITCHES & TERMINALS..... 2
- OPERATION OF CONTROLS 16
- PLAYBACK FROM TUNER 11
- PLAYBACK FROM TAPE DECK 12
- RECORDING ON TAPE 13
- LEGS, RACK-MOUNTING 7
- CONNECTION PROCEDURE 8
- PLAYBACK FROM RECORD DISCS 10
- STANDARD CURVES 19

Thank you for Purchasing the SC50

Although it is the basic role for an amplifier to amplify the music signals faithfully, this is in actual practice hard to be carried out. Music signals are, as you know, the wave-signals that are never repeated, therefore, not only the wave-form but the time lag (phase characteristics) must be considered for the high fidelity amplification.

We have titled the SC50 with the indication "REAL TIME PROCESSED", since we have been delving into the phase characteristics and obtained a satisfactory solution.

We have adopted a DC-camp configuration in order to improve phase distortion in low frequency as well as transient distortion in high frequency range. Also several measures have been bestowed to eliminate non-linear distortion which appears only at the time of actual use, when connecting cartridge etc.

Of course it is necessary to solve the DC-drift problem caused by

variation of temperature or ambient conditions in case DC-camp configuration is adopted. We realized perfect counter-measures to suppress the DC-drift by developing the DML-C, in which the differential circuit by original F.E.T's and the cascade circuit, current mirror circuit, the constant current circuit etc. to assist the differential are effectively arranged.

Further selected components are used; resistors of trimmer potentiometers of metalized film type which is small in temperature coefficient and low noise capacitors of dipped silvered mica type which gives superb characteristic against non-linear distortion.

We recommend that you choose with care other Hi-Fi components for optimum operation in combination with the SC50, and go through the contents of this owner's manual to make the most of the potential of this preamplifier.

WARNING: TO PREVENT FIRE OR SHOCK HAZARD DO NOT EXPOSE THIS APPLIANCE TO RAIN OR MOISTURE



SWITCHES & TERMINALS

1. Input Selector Switch

This switch permits you to select desired program source. Either of 5 positions (aux, tuner, phono-1, phono-2, phono-MC) can be selected.

Note that the "phono-MC" position is exclusively for an MC (Moving Coil) cartridge and that the corresponding PHONO-MC Terminal (20) functions only when the exclusive step-up transformer is plugged into the Socket for MC Input Transformer (21).

2. Input Impedance Adjuster for PHONO-1 & 2

The desired impedance for the MM (Moving Magnet) cartridge can be obtained by this Adjuster between 30K ohms - 100K ohms. Turn the knob to obtain the optimum load resistance of your cartridge. The left knob is for the PHONO-1 Terminal (18) and the right for the PHONO-2 Terminal (19). A click stopper is provided at the "50K" position and an approximate impedance can be known by the slit of the knob. For further details refer to Input Impedance Adjuster.

3. Linear Equalizer

This is a new tone control which provides a total compensation of linear nature for subtle reinforcement of frequency response. With the control in its midposition flat frequency response is obtained. When switched to either of the 2 "up-tilt" positions, the entire response curve is slightly rotated so as to linearly increase treble response while simultaneously decreasing bass response. Conversely selection of a "down-tilt" position rotates the response curve in a clockwise direction and provides a gradual decrease of treble and a simultaneous increase of bass.

This Equalizer is inserted at the flat amplifier section and is effective on all the program sources. For further details refer to Operation of Linear Equalizer.

4. Mode Selector Switch

This switch allows selection of reproduction mode among 3 positions (stereo, mono, reverse). For normal stereophonic playback, set the Switch at the "stereo" position. For further details refer to Mode Selector.

5. Tape Monitor Switch

This allows you to select reproduction through Tape Monitor Terminals. This Switch divides the amplifier into 2 sections: one from each input terminal to the REC. OUT terminal and the other from the Monitor terminal to the PRE OUT terminal. At the "tape-1" position reproduction of tape deck is feasible either from the TAPE-1 MONITOR Terminal (24) or from the TAPE-1 TAPE CONNECTOR (25). Likewise the "tape-2" position permits reproduction from the TAPE-2 MONITOR Terminal (27).

6. Tape Reprint Switch (Dubbing)

Tape dubbing is possible with this switch. When the lever is set at the "1 to 2" position, the playback signals of the TAPE-1 MONITOR Terminal (24) can be copied on to TAPE-2, and vice versa at the "2 to 1" position. While in the dubbing process, it is possible to monitor with the Tape Monitor Switch (5). This reprinting circuit is independent and reproduction of other sources such as record or tuner is possible during the tape dubbing process.

7. Subsonic Dip Frequency Selector

This selector functions in combination with the Subsonic Filter (8). When the lever is set at the upper position the filter circuit is put into operation with the dipping center frequency at 7Hz, while the lower position causes the filter circuit to operate at 4Hz. At the center "off" position the filter circuit is completely bypassed.

8. Subsonic Filter

This switch functions to remove ultra low frequency noises when the Subsonic Dip Frequency Selector is set at the 7Hz or 4Hz position. The circuit composed of a twin-T type filter and a CR 1-stage filter varies the dipping amount.

As the knob is turned in the counter-clockwise direction (towards the "sharp" position) the dipping amount will increase gradually, while as it is turned in clockwise direction (towards the "broad" position) the dipping amount will decrease. At the end-most clockwise position the filter has a cutoff rate of -6dB/oct. For further details refer to Operation of Subsonic Filter and Characteristic Curve.

9. High Cut Filter

This is composed of an NF type filter circuit with a sharp cut off rate of 12dB/oct. It is effective in removing unnecessary ultra treble noises. When the lever is lifted up to upper position high frequency range above 12KHz is cut off while at the lower position high frequencies above 18KHz are attenuated. In the center position the filter circuit is bypassed and flat frequency response is restored.

10. Audio Attenuator

Occasionally during late night listening (or in case an overrated input is connected to the input terminals) it is difficult to render fine adjustment of volume only with the Volume Control (13). In such cases this Attenuator makes it easy. First lift up the lever to the "preset" position, and then set the Preset Volume (11) to an appropriate position. When the lever is pressed down at the "signal off" position, the audio signals are blocked here and no reproduction

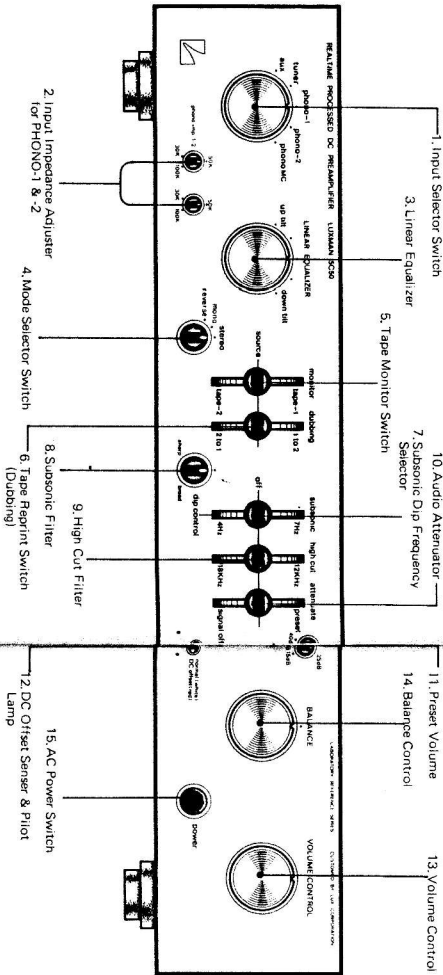

is feasible. This is convenient for momentary stoppage of operation, (e.g., while replacing cartridges etc.)

11. Preset Volume

When the Attenuator Switch (10) is lifted up to the "preset" position, this volume controls to function. At the endmost clockwise position of this knob the volume level is attenuated by 15dB, and as the knob is turned in the counter-clockwise direction the amount of attenuation increases to 40dB at the ultimate counter-clockwise position. In other words attenuation level can be freely adjusted in the range of 15dB-40dB.

12. DC Offset Sensor & Pilot Lamp

This amplifier is of DC amp configuration and perfect measures are taken against DC drift problem inside the unit. However, it is possible that DC ingredients may exist from the output terminals of audio equipments coupled to the input of this unit, and in this case it is imperative to prevent abnormal operation that may be triggered by such leakage of DC ingredients. For this purpose the DC Offset Sensing Circuit is provided.

This lamp plays the role of pilot lamp as well, and lights up in white when no DC ingredient is included in the input signals. In case DC voltage exceeding $\pm 450mV$ is sensed at the output of flat amplifier, it will change to red to warn that some DC ingredients are present at the input.

13. Volume Control

Adopted for the SC50 is a new and ideal volume control which realizes the least gangerror and the continuous variation response at the same time. Therefore, smooth and accurate control of volume is feasible. A clockwise turn of the knob increases volume, while counter-clockwise turn decreases and finally cuts off volume.

Note that a time-delay muting circuit is incorporated in the output stage, which isolates the output power is turned on, so as to eliminate shock noises or thumps at the time of on/off operation of the power switch.

Therefore if the volume control is left increased, loud sound may suddenly appear because of operation of the time-delay circuit, and it is recommended that you set the volume control at the counter-clockwise position before operating this unit.

14. Balance Control

The volume balance between the right and left channels can be adjusted by this control. Turn it clockwise, and the volume level of the left channel is reduced. Conversely, a counter-clockwise turn causes decrease of volume at the right channel. When the volume of both channels is balanced, monaural playback sound comes from the center of both right and left speakers. Usually this point is obtained at the center click position.

15. AC Power Switch

Press in the switch and the Pilot Lamp (12) starts to blink for about 5-10 seconds, and then lights up in white, which shows that this amplifier is put into perfect operational condition. The next push shuts off the AC power.

16. AUX Terminal

This is an auxiliary input terminal for playback of flat frequency response program sources such as AM/FM tuner, line output of tape recorder, or audio output of TV receiver. Input sensitivity is 150mV and input impedance is 50K ohms.

17. Tuner Terminal

This is for playback of a tuner (AM/FM/LW/SW). Input sensitivity is 150mV and input impedance is 50K ohms.

18. PHONO-1 Terminal

Output of magnetic cartridges (MM, MI type) can be reproduced via these terminals. Input sensitivity is 2.5mV. Input impedance can be adjusted between 30K ohms and 100K ohms by the Input Impedance Adjuster (2).

19. PHONO-2 Terminal

This functions in the same way as the PHONO-1 Terminal.

20. PHONO-MC Terminal

This Terminal is provided exclusively for reproduction of MC (Moving Coil) cartridge. Note that this terminal functions only when the matching step-up transformer (an optional item) is plugged into the Socket for MC Input Transformer (21). In case no transformer is inserted, no playback is possible via this Terminal.

21. Socket for MC Input Transformer

If you plug the exclusive optional MC input transformer into this Socket the PHONO-MC Terminal is coupled inside the unit, which makes it possible to use an MC type cartridge. Incidentally the exclusive MC step-up transformer has 2 high quality toroidal cores for stereo-phonographic reproduction, reflecting LUX's unflinching research for the ultimate in high fidelity reproduction.

22. Earth Terminal (GND)

Connect the earth lead wire of record player (from motor or pickup arm) or graphic equalizer. Especially when A-B listening test is conducted with many amplifiers, common grounding is effective to remove shock noises at the time of switching.

23. TAPE-1 REC. OUT Terminal

A recording signal is taken out from this Terminal, which is always available when an input signal is applied to either of the input terminals. In case the Tape Reprint Switch is set to the "2 to 1" position, recording signals come from the TAPE-2 Monitor Terminal.

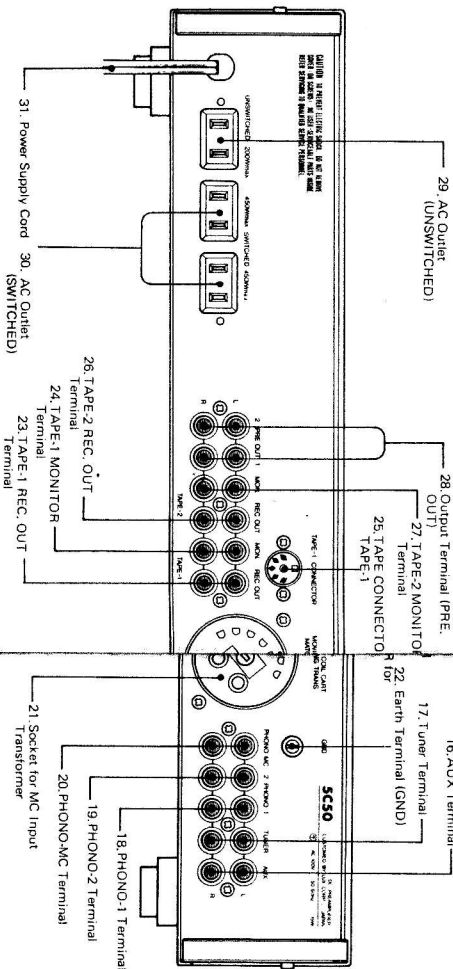

24. TAPE-1 MONITOR Terminal

The line output of tape recorder is reproduced via this Terminal. This is put into operation when the Monitor Switch (5) is set to the "Tape-1" position. The use of a 3-head tape deck permits simultaneous playback monitoring while recording.

25. TAPE CONNECTOR for TAPE-1

This connector is of DIN standard. With the recording output terminal (REC. OUT) and the tape monitor terminal in it, connection for recording and playback is feasible with a single patch cord with DIN plug provided that the tape recorder has the same connector. For playback through this connector, the Monitor Switch (5) has to be set at the "Tape-1" position and the Tape Reprint Switch (6) has to be at the center position. Output signal for recording is always available except when the Reprint Switch is set to the "2 to 1" position.

26. TAPE-2 REC. OUT Terminal

This offers the same function as the TAPE-1 REC. OUT Terminal (23). In case the Tape Reprint Switch is set to the "1 to 2" position, signal from TAPE-1 Terminal is available.

27. TAPE-2 MONITOR Terminal

This terminal functions in the same way as the TAPE-1 Monitor Terminal. It is put into operation when the Monitor Switch is set at the "Tape-2" position.

28. Output Terminal (PRE. OUT)

The output of this amplifier can be taken from these Terminals. 2 pairs are provided to drive 2 sets of power amplifiers. You need not worry about possible attenuation at high frequencies caused by a long pin jack cord because this terminal has a sufficiently low output impedance of about 500 ohms.

29, 30. AC Outlet

You can supply AC power to other audio equipments through these outlets. The terminal (29 UNSWITCHED) is independent of the AC power switch of this

amplifier, while the others (30 SWITCHED) are coupled to the power switch. The total capacity for the UNSWITCHED is 200W, while the rated capacity for the SWITCHED is 900W.

Note that in some countries these outlets are not provided, because they are not allowed by law.

31. Power Supply Cord

Plug in the end of this cord to the power supply socket in your listening room.

About DC Offset Senser

This preamplifier is of DC amp configuration and in case leakage of some DC ingredients is present at the output terminals of the equipment connected to the SC50, the operational point of this amplifier goes wrong, and may possibly be unable to realize the full performance. Therefore, the DC Offset Senser is provided to check the existence of DC ingredients.

This lamp plays the role of pilot lamp as well, and lights up in white when no DC ingredient is included in the input signal. In case DC voltage exceeding $\pm 450\text{mV}$ is sensed at the output of that amplifier, it will change to red to warn that some DC ingredients are present at the input.

In this case, there would be possible leakage of DC ingredient at the output terminals of the equipment, connected to the SC50, therefore check your tuner or tape deck etc. and remove the cause.

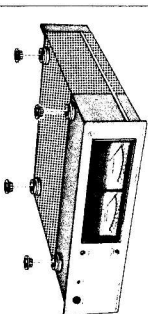

Attached leg caps

The illustration is for the SM21 power amplifier, but all the models in Laboratory Reference Series adopt the same construction for smooth placement.



Rack Mount Adapters

About the Legs

All the components in our Laboratory Reference Series are provided with legs at the bottom and metallic receptacles on the top. A metallic support is placed between the leg and its receptacle. Thus you need not worry about breakage caused by accumulated weight even when units are stacked one by one, as the total weight is applied to the legs of the unit placed at the very bottom of such a stack. Perfect fit between the legs and receptacles prevents each component unit from falling or sliding. However, if the unit is placed on the furniture or other kind of wooden cases, with these legs as they are, it is possible to cause a slip or scratch. To prevent this,

4 leg caps of synthetic resin are provided as accessories. When some of the components in our Laboratory Reference Series are stacked, the leg caps should be attached to the legs of the last unit placed at the bottom of such stack. To fix them refer to the drawing.

About Rack-Mounting

In order to mount the SC50 to the rack of EIA standard, adapters are available on request. Note that the size of the adapter is different by models.

LEGS
RACK-MOUNTING

CONNECTION PROCEDURE

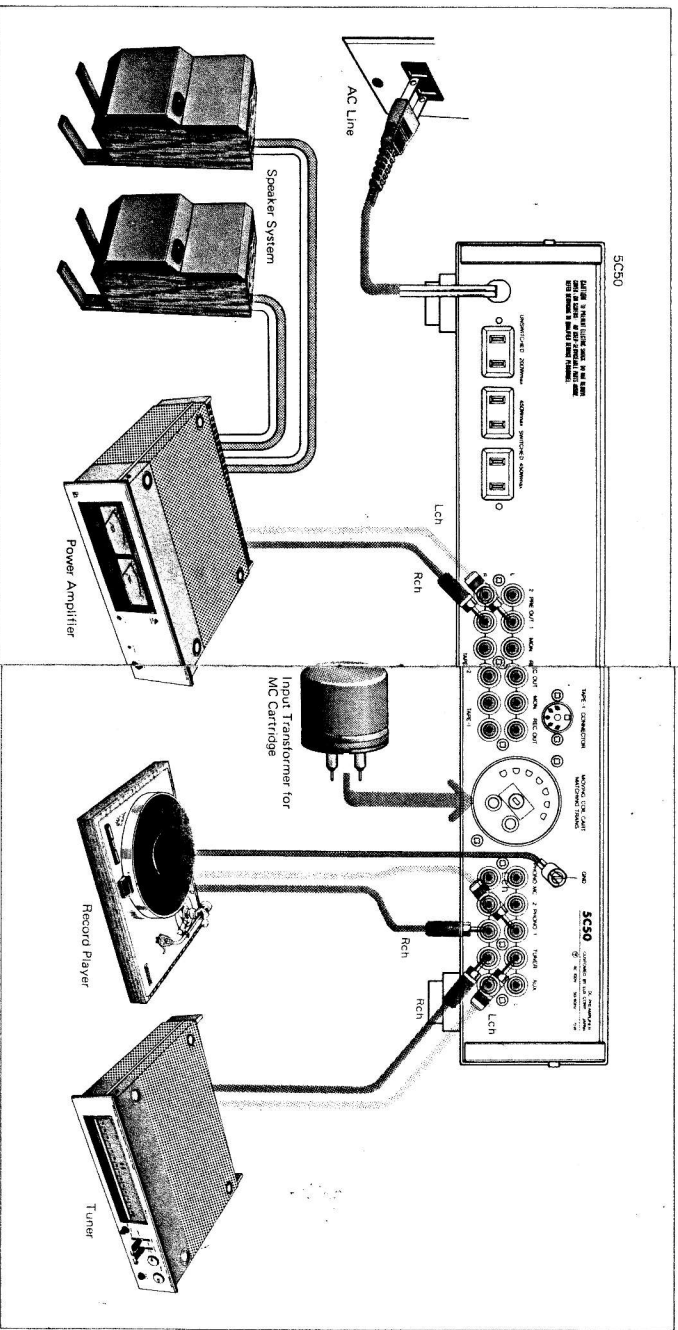

Connection of Input Terminal
The output of a turntable, FM/AM tuner or tape deck should be connected to the corresponding input terminal of this pre amp. For further details refer to "Reproduction of Program Sources".

Connection of Output Terminal
This unit is provided with 2 pairs of output terminal, either of which can be connected to the input terminal of your power amplifier. Check carefully that both right and left channels are correctly hooked up. To avoid mis-connection it is recommended to use 2 pin jack cords of different colour.

In the LUX's Laboratory Reference Series a graphic equalizer and a tone control unit are separately available for extensive and diversified tailoring of playback sound according to one's taste. If you possess one of these components, the output of this pre amp

can be connected to the input terminal of such components.

Connection of Speakers to Power Amplifier
Stereophonic playback is realized with a pair of speakers for right and left channels. The right speaker system (viewed from the listener's position) has to be hooked up at the right output terminal of the power amp. While the left speaker should be connected to the left terminal.

Note that perfect sound reproduction cannot be expected if the phase is not matched in both channels. To match the phase, connect the (+) terminal of the right speaker to the (+) terminal of the power amp., and the (-) terminal to the (-) one (black cap), do the same with the left speaker system. If mismatched for some reason (e.g., mis-connection of speakers),

the low frequency range is subdued and stable playback cannot be realized. To hook up the speaker systems, it is recommended that you use heavy gauge cord of good quality, and as short as possible.

Connection of AC Power Supply Source:
As the final step of preparation, connect the amplifier to the AC power supply source. Connect the AC Cord (31) to the power supply outlet. Then press the AC switch (15). The DC Offset Sensor & Pilot Lamp (12) will blink, and the Time-delay Muting Circuit is turned on after 5 - 10 seconds to activate the output circuit. At this time the Pilot Lamp remains lit on to show the amplifier is put into operational condition.

Pin-Plug Cord for Connection
For connection of the record player, tuner, and tape-recorder, shield wire is advisable to be used for protection from external noise or inductance noise. Usually, this shield wire has a capacitance of approx. 200pF/m, and even so has 35 - 100pF/m, i.e., the adoption of a connection cable gives the same effect as that of the insertion of a capacitor in parallel with input sources or output load equipment (which comprises a kind of high-cut filter circuit). All of LUXMAN products are so designed as to be low in output impedance and high in input impedance, which prevents such effect. But it is advisable to choose a shield wire of good quality and use it as short as possible for connection of this amplifier (at PHONO, AUX, Tape-monitor etc.) with the high impedance equipment.

PLAYBACK FROM RECORD DISCS

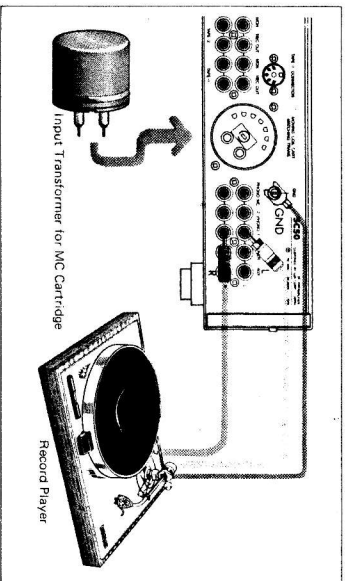

Connections:

The player has 2 cords with pin plugs at their ends for both right and left channels. Connect the pin plugs to the input terminals of this amplifier [PHONO-1 (18)] or [PHONO-2 (19)]. When you use low output (0.01 - 0.1mV) MC type cartridge, it is necessary to boost the output up to the level of Input Sensitivity of the PHONO terminals. For this purpose an MC type Input Transformer is available on request, and a Socket for MC Input Transformer (21) is provided. The PHONO-MC terminal (20) is connected to the equalizer circuit only when the MC Input Transformer is inserted to the socket (21).

Signal Paths:

Put the disc on the turntable, switch on the phono motor, and set the stylus on the groove of the disc. Then recorded signals begin to be fed to the amplifier. First, the signals fed to the amplifier through PHONO terminals are brought to the equalizer section, where recorded signals are restored to the original frequency curve. Incidentally, this equalizer curve has been standardized to the RIAA curve. The equalized signals are then fed to the input selector switch (function switch). If this switch is not set at the "phono" position, the signals are blocked here and no amplification is possible.

After the input selector switch one line goes to the REC. OUT terminal, and the other to the tape monitor switch. If the Tape Monitor Switch is set to the "source" position, the signals are sent to the mode selector switch,

balance and volume controls, but if at the "deck-1" or "deck-2" position, the signals are stopped at the tape monitor terminals. Except during tape playback, the monitor switch must be kept at the "source" position. But when the input signals are fed to PHONO or AUX terminals, recording output is always obtainable regardless of the position of the monitor switch.

Then the signals are sent to the volume control through the mode selector and balance control. In case the volume control is turned to the most counter-clockwise position, signals are blocked here, therefore it is necessary to set it to an appropriate sound level.

Next, signals are fed to the hi-amp section to be voltage-amplified. Such controls in this section as Linear Equalizer, subsonic filter, high-cut filter etc are for flexible and diversified adjustment of playback sound and do not block the signals completely.

The last stage is the Audio Attenuator. When the switch is set at the "off" position, signals go forward, while at the "signal off" position, signals are stopped here. At the "preset" position, signals reach the input terminals of power amplifier through the output terminals of the EGS5.

Sound reproduction of a record disc is thus realized from speaker systems. For your pleasant command of this amplifier, we recommend that you "bear" the block diagram in your mind.

Playback:

Put a disc on the turntable for playback. As the volume control is

turned clockwise, playback sound comes from the speakers. As explained above, playback is possible regardless of the position of the Mode Selector, etc. Such controls as Input Selector Switch, Tape Monitor Switch, and Volume Control should be set at the correct

positions. After all preparations are completed, check if the volume levels on both right and left speakers are identical. If different, adjust them with the Balance Control. For stereophonic playback, set the Mode Selector Switch to the "stereo" position.

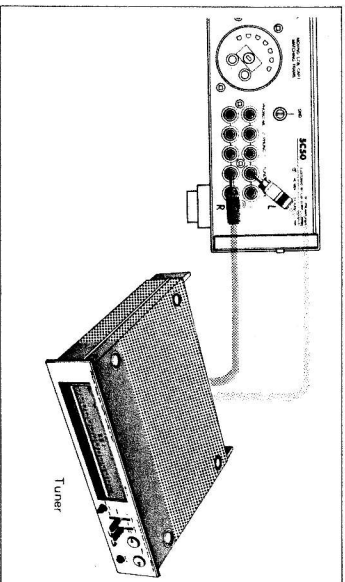

Playback from Tuner:

Connect the tuner's output terminals (left and right) to either of the amplifier's AUX terminals or to the Tuner terminals.

The Input Selector Switch must be set at the corresponding position. As shown in the block diagram, the input signals from the tuner are fed directly to the input selector circuit. Afterwards, the signals trace the same blocks as are explained in the TAPE DECK section and are reproduced from the speaker systems. Both for FM stereophonic and monaural broadcasting, the Mode Selector Switch should be set at the STEREO position, for such accommodation to the input source can be made in the tuner. Modulation hum in the AM program can be eliminated by varying the distance and angle of these components.

PLAYBACK FROM TUNER

PLAYBACK FROM TAPE DECK

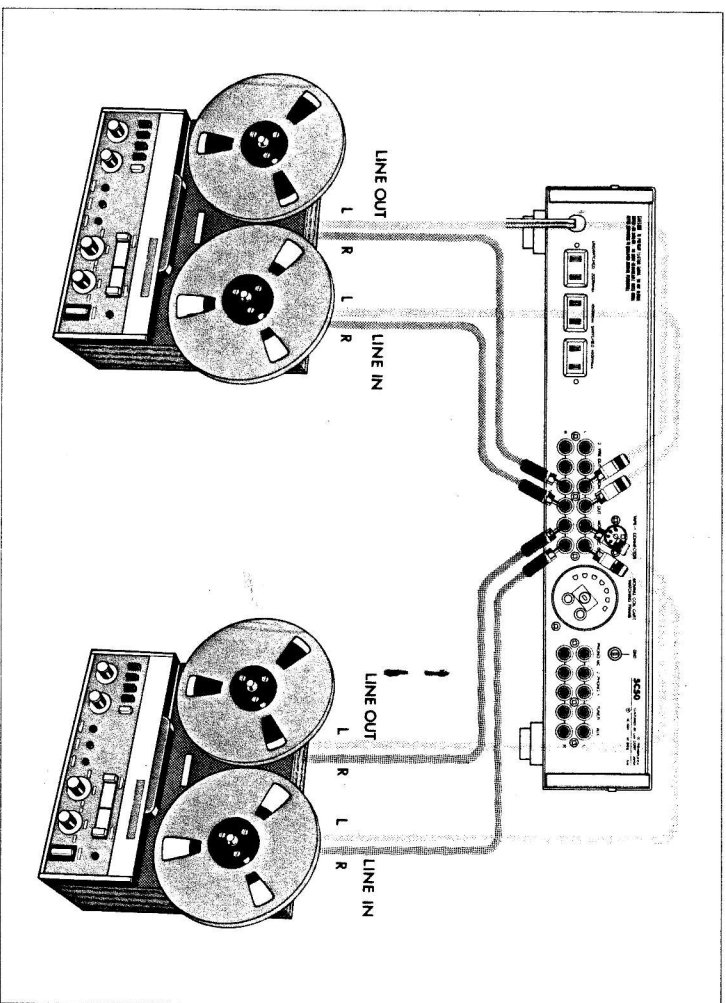

Playback from Tape Monitor Terminals:

Almost all tape-recorders and tape decks currently marketed include an equalizer amplifier in their circuitry, and some tape-players are made exclusively for playback.

Connect the output terminal (LINE OUT) to the Tape Monitor terminals (20) or (23). Then set the Monitor Switch at the corresponding position to which the tape-recorder is connected. If two tape-recorders are connected to the terminals (20) and (23), selection of either unit is possible by the Tape Monitor Switch (6).

This amplifier can be divided into two sections: one before the Recording Output terminals (REC. OUT) and the other after the Tape Monitor Switch. A 3-head tape-recorder makes it feasible to make recordings with the former section and simultaneously make playback

with the latter section.

Note that a normal function recorder for playback of tape-recorders for playback of DECK-1 and Tape Connector (21) at the same time, since these two are coupled in the inside circuit and affect each other. Therefore, if the Tape Monitor terminals and the Tape Connector, are used, the tape-recorders should be connected to the terminals of DECK-2 Monitor Terminal and the Tape Connector.

Playback from Tape Connector:

This is a DIN connector and is convenient for simple connection with a patch cord between the tape-recorder and recording/playback connectors of this amplifier. Playback from the Tape Connector is

possible if the Monitor Switch is set at the "Tape-1" position.

Playback from AUX Terminals:

Playback of tape is possible if the line output of the tape-recorder or tape-deck is connected to the AUX terminals of this amplifier by use of a pin-jack lead, and the Input Selector Switch is set at the position corresponding to the AUX terminals. All operations in this case are the same as those for the playback from tuner (Page 11).

Note that when tape playback is made through the AUX terminals, the line input or AUX input terminals of the tape-deck should be kept free. If connected to the Recording Output terminals (REC. OUT) of the amplifier, there will be possible oscillation by feedback of signals.

Recording on Tape:

In the case of playback of various program sources through input terminals of this amplifier, the same signals as those reproduced in the speakers are always available at the REC. OUT terminals and the Tape Connector. By connecting these terminals to the input terminals (AUX or LINE IN) of the tape-recorder, you can enjoy simultaneous recording and playback. (It is recommended that the Dubbing Switch be kept at the "source" position.) These recording signals are taken out before the tape monitoring stage, and there is no influence of the Filters, Volume control, etc. as far as the quality of the recorded signal is concerned.

Tape Dubbing (REPRINTING)

With this amplifier, it is possible to reprint from one tape-recorder to another. Connect the line output terminals and the line input (or AUX) terminals of one tape-recorder to the DECK-1 Monitor and REC. OUT terminals of the amplifier, respectively. Likewise, connect the line input and output of the other tape-recorder to the DECK-2 Terminals.

Dubbing is now possible by use of the Dubbing Switch. At the "1 to 2" position, the signals of DECK-1 can be reprinted on the tape of the DECK-2 terminals, and vice versa at the "2 to 1" position. In this way, repetition of switching between "source" and "1 to 2" or "2 to 1" makes it possible to compare the master tape and the reprinted tape.

The dubbing circuit is independent of the main signal paths, and disk or tuner reproduction is feasible in the course of tape dubbing operation when the Tape Monitor Switch is at the "source" position.

Simultaneous Playback Monitoring and Recording:

A 3-head tape-recorder ensures simultaneous playback monitoring and recording. In this case, recording on tape and playback of the recorded sound are done at the same time, and connections must be made for both functions. It is necessary to connect the REC. OUT terminals to the line input terminals of the tape-recorder, and the Tape Monitor terminals to the output terminals (LINE OUT) of the tape-recorder.

RECORDING ON TAPE

When the Tape Monitor Switch is set at the position corresponding to the terminals to which the tape recorder is connected, repetition of switching between "source" and "tape-1" or "tape-2" allows a comparison between the original and the recorded sound. Possible recording errors can thus be prevented. Incidentally, note that reproduction of recorded sound becomes a little delayed as compared with that of the original sound since there is a gap between the recording head and the playback head.

Simultaneous playback monitoring can be made through the Tape Connector as well. A single piece of DIN cord ensures connection for recording and playback on the Tape Connector, and simple operation of the Tape Monitor Switch switching between "source" and "tape-1" is sufficient.

Simultaneous Recording:

This amplifier is provided with 2 sets of Recording Output terminals (19, 22), enabling to record simultaneously on 2 tape recorders. When the same connection as that of "TAPE DUBBING" is done and the Dubbing Switch is set at the "source" position, repetition of switching of the Monitor Switch among those positions "tape-1", "source" and "tape-2" allows to compare the original sound with 2 recorded ones during simultaneous recording.

Note: In this case, if the Dubbing Switch (7) is set to the "1 to 2" or "2 to 1" position, the signals are not obtainable at either of REC. OUT terminals.

If desired, combination recording on open-reel recorders and/or cassette recorders can be enjoyed. Moreover, if the Tape Connector is used, recording on 3 tape recorders or combinations is possible. This facility is useful for safe printing or effective recording, etc.

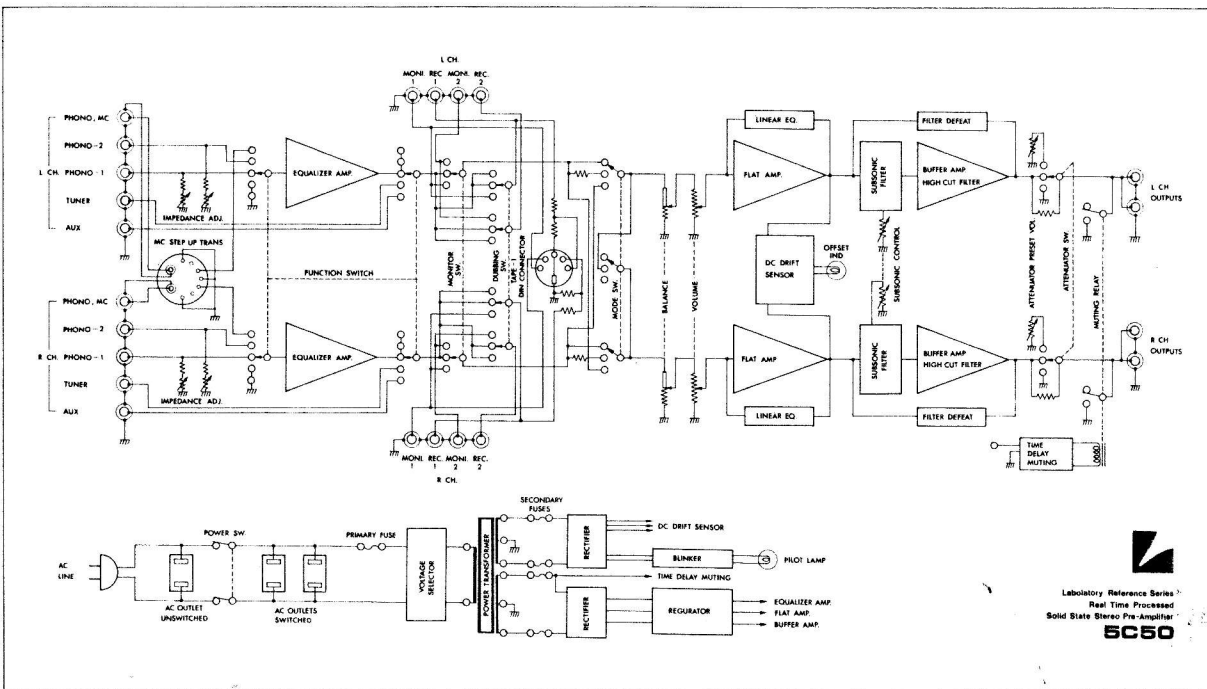

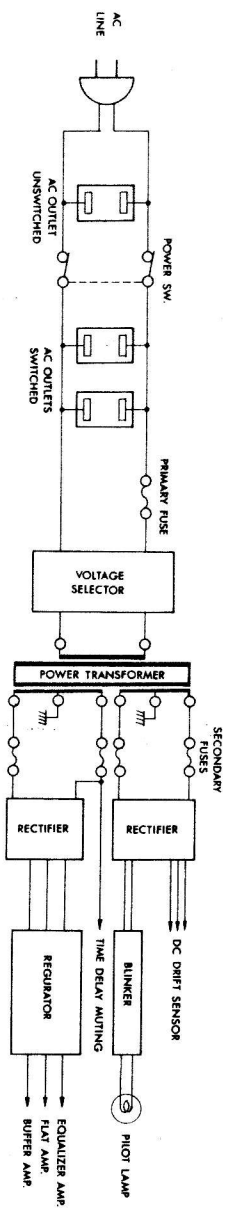
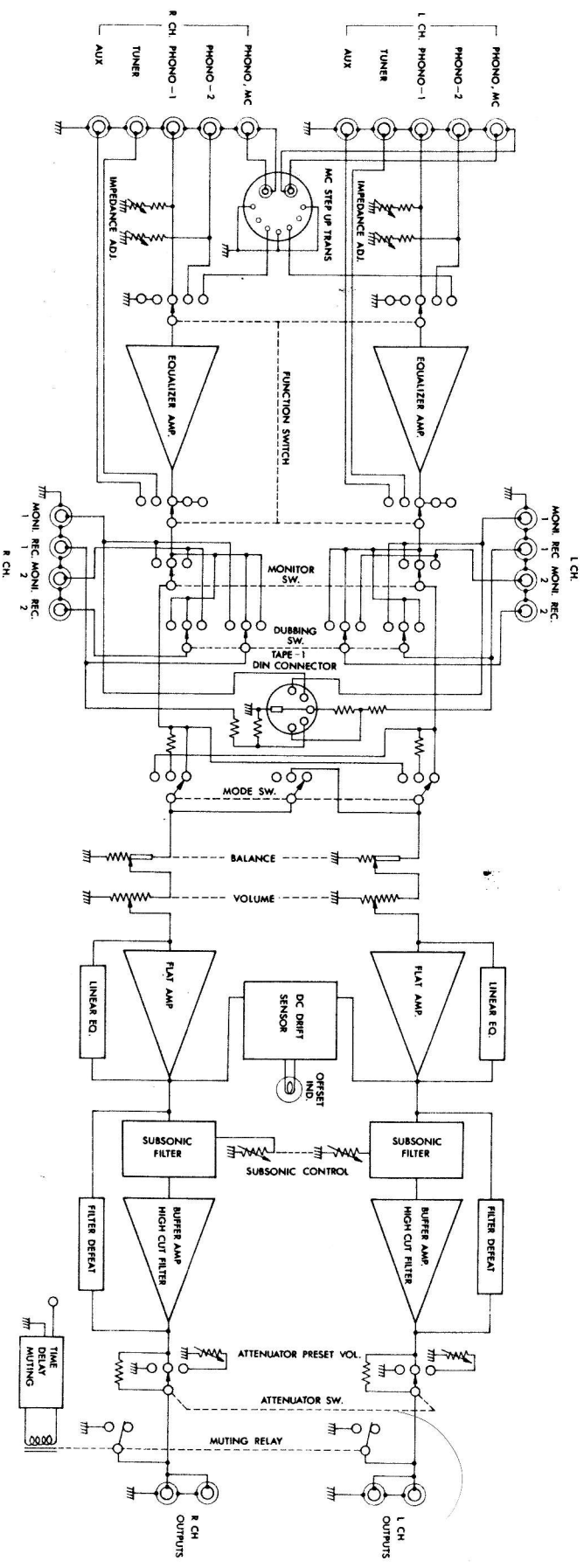

Laboratory Reference Series
 Real Time Processed
 Solid State Stereo Pre-Amplifier
SC50



OPERATION OF CONTROLS

Mode Selector

This amplifier is for stereophonic reproduction and incorporates independent amplifiers for 2 channels (right & left). The Mode Selector is placed between the two amplifier channels to change the playback mode. This switch has 3 positions, namely, stereo, mix, and rev. Select an appropriate position.

Stereophonic Playback

When this switch is set at the "stereo" position the two amplifier channels function independently to ensure normal stereophonic reproduction, i.e. the signals fed to the right input terminal are reproduced at the right channel speaker and the input into the left channel is realized for reproduction at the left channel speaker.

Monaural Playback

With the switch at the "mono" position the signals of the 2 amplifier channels are mixed together to effect monaural reproduction. This position is useful when both right and left channels are being fed monaural signals, or when stereophonic signals are to be reproduced in the monaural mode (e.g. to check the volume balance between the right and left channels). In this position you may use either of the right and left channel inputs. Occasionally you may want to play back a monaural disk. In that case you need not take the trouble to use a monaural cartridge. With a stereophonic cartridge, if the Mode Selector is set at the "mono" position, unpleasant noises are cancelled and better performance will be obtained.

In the case of FM playback switching to stereo or mono is performed inside the tuner, and you can keep the Mode Selector at the "stereo" position at all times.

Stereophonic Reverse Playback

In the "rev" position the output channels are reversed in relation to the input, that is to say, the input into the right channel is reproduced from the left channel speaker, and vice versa. This position can be used to correct a reversed input of program source.

Volume Control

Obtain an adequate volume level with this control. A clockwise turn increases the volume level, while a counter-clockwise turn decreases and finally cuts it completely. A

precision detent-volume of high-grade attenuator assures precise adjustment on both the right and left channels without gang error.

Volume Control

The variable resistor of this control has a logarithmic curve. In the attenuation characteristics of so called A type, the turning angle is proportionate to the attenuation degree (dB), and the dB value and the volume audible to human ears are in the proportional relation. In other words, the rotation of the control is in proportion to the sound volume sensed by human ears. Thus, the increase of volume seems quite natural as the control is turned in the clockwise direction.

However, it may not be easy to make a fine-tune control in case of the late-night listening at low level or over-rated input at input terminal. In that event, first set the attenuator (10) at the "preset" position and make a fine-tune control with the Preset Volume (11).

This unit is provided with the time-delay muting circuit to isolate the output circuit for about 5-10 seconds until the entire circuitry is put into operational condition. Therefore, if the main Volume Control (13) is set at a high level before operation, loud sound comes out all of a sudden. Set the main volume at a low level before operation, and obtain an appropriate level after sounds come out.

Balance Control

In case a difference is detected between the volume levels of right and left channels, adjust the unbalanced volume level with the Control (14). A complete-turn of or counter-clockwise direction causes a cut-off of the volume of the other speaker. The volume balance of both channels can be adjusted so that monaural reproduction by means of the Mode Selector (14) at the "mono" position seems to come from the center between right and left channels. At the mid position the volume of both channels can be adjusted at the same level. If a program source established throughout all playback stages is unbalanced for some reasons (or the speakers are placed in an oblique position), establish the correct balance with this control.

Linear Equalizer

All the program sources available in the marketplace are not always perfect. Record disks and tapes which are most frequently used as a program source are liable to have a slight frequency deviation of linear nature depending on the manufacturing.

For example, all recordings are equalized in accordance with RIAA standard, but it is quite common to encounter variations in overall tonal balance from one recording to the other. Also, differences in listening environment and room acoustics often require a subtle degree of tonal compensation that conventional tone controls cannot correct because of their wide range and overlapping characteristics.

The Linear Equalizer control provides a new form of tonal compensation especially intended for this sort of tendency. With the control in its mid-position, flat frequency response is achieved. Switched to either of 2 "up-tilt" positions, the entire response curve is rotated on a 1KHz axis so as to linearly increase treble response while simultaneously decreasing bass response. Conversely, selection of one of the "down-tilt" positions rotates the response curve in a clockwise direction, providing a gradual decrease of treble response and simultaneous increase of bass response. Degree of slope for either positive or negative settings has been carefully preset, and the overall response maintains complete linearity from 50Hz to above 10KHz, unlike the curvature in response normally associated with ordinary tone controls.

Specifically, when the control is turned to the first "up-tilt" position, it will decrease bass and increase treble by 0.5dB at 100Hz and 10KHz respectively, while selection of the 2nd "up-tilt" position will result in a 1.3dB cut and boost at these same frequencies. Selection of the first "down-tilt" position will decrease treble and increase bass by 0.6dB at the same reference frequencies, while the 2nd "down-tilt" position provides 1.3dB boost at 100Hz and cut at 10KHz.

This control is inserted in the flat amp circuit and is effective on all program sources. It introduces no increase of harmonic distortion at any of its settings because of the inherently linear nature of this circuit.

This unit offers no tone control facilities, and in case more versatile

and diversified tonal compensation is required on the total playback system (including room acoustics), it is recommended that you purchase either the Graphic Equalizer SG12 or the Tone Control Unit SP-70 which are offered in our Laboratory Reference Series.

Operation of Subsonic Filter

Ultra low frequency noises (5-50Hz) caused by record warps, tone-arm's resonance, phono-motor's rumble and acoustic feedback etc., are harmful in reproduction even if they are out of audible range (below 20Hz) as they produce inter-modulation distortion by vibrating the cones of loudspeakers. To remove such harmful ultra low frequency noises with the least effect on the audible frequency range, this unit is provided with the Subsonic Filter.

Normally to eliminate this kind of ultra low frequency noises an NF type filter with active components can be considered which offers sharp cut-off characteristics. With this unit, however, active components should be avoided in view of the DC amplifier configuration, and the twin-T filter consisting of capacitors and resistors is combined with a 1-stage CR filter to offer an effective subsonic filter in the total characteristics.

The Subsonic Filter is composed by the subsonic dip frequency selector (7) to select the dip center frequency and the subsonic control (8) to adjust the cut-off characteristics. The subsonic dip frequency selector has 2 points (4Hz and 7Hz), either of which can be selected as required. When the knob is set at either "4Hz" or "7Hz" position, the subsonic control starts to function. The dip is intensified as the subsonic control is turned in the counter-clockwise direction towards the "sharp" position, while the degree of the dip becomes mild as the knob is turned towards the "broad" position. At the most clockwise position an attenuation of -6dB/oct is provided. When the subsonic dip frequency selector is set at the center "off" position, the entire circuit of the Subsonic Filter is bypassed and signals receive no influence from this circuit.

STANDARD CURVES

Operation of High Cut Filter

This High Cut Filter is of NF type with the cut-off characteristic of -12dB/oct. Cut-off frequencies are selected to remove the ultra high frequency noises with the least effect on the audible frequency range.

When the high cut filter (9) is set at the "12KHz" the amount of high frequencies you hear above 12KHz is sharply reduced at the rate of 12dB per octave. This is useful for removing hissing noise of tape. The "18KHz" position offers an attenuation at the rate of -12dB/oct. on the ultra treble range above 18KHz. This position is effective to remove the ultra high frequency noises for example as a canceller of the FM pilot signals or as a control of harmonics components in the signals. At the center "off" position the signals bypass this circuit.

Input Impedance Adjustment

Almost all of the currently marketed cartridges of MM type specify recommended optimum load impedance of about 50K ohms. It is known that variation of load impedance affects the frequency response to a great extent.

Generally speaking, a low load impedance attenuates treble response, while a high impedance causes a peak in the treble range. The variation of such effect depends on the cartridge you possess, but generally a cartridge with higher inner resistance tends to be more delicately influenced. It is, therefore, necessary that selection of a proper impedance should be made with this adjuster.

This unit is provided with 2 sets of PHONO Terminal, whose load impedance can be freely adjusted between 30K ohms-100K ohms. The input impedance on the PHONO-1 Terminal (18) can be

adjusted by the left knob (2), while that of the PHONO2 (19) depends on the right knob (2). The input impedance becomes 100K ohms at the most clockwise position of the adjuster, while the extreme counter-clockwise position offers 30K ohms. At the center click point impedance is 50K ohms. Obtain the proper input impedance matching with your cartridge, as you can easily read the impedance value by the indicator on the knob.

The chart below shows the effect of load impedance on the frequency response with a typical MM cartridge.

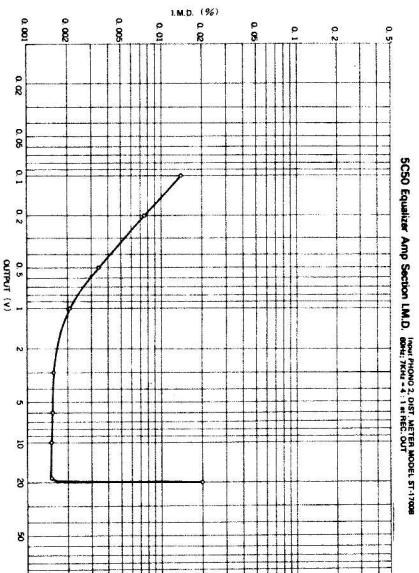
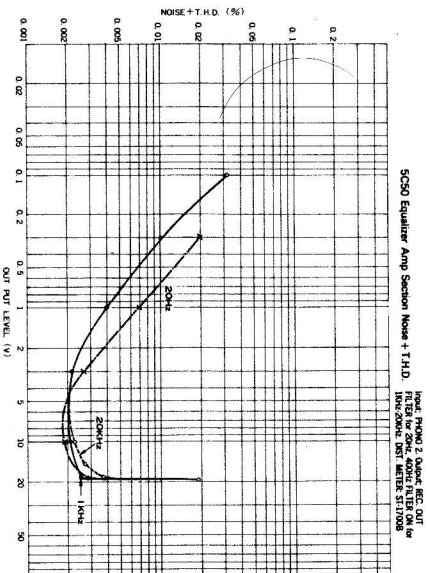
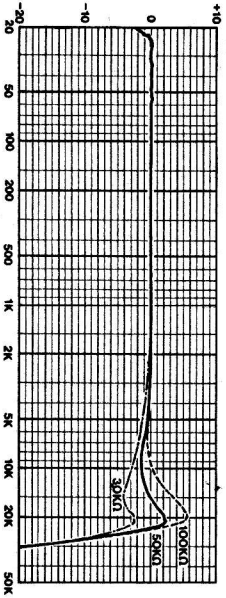

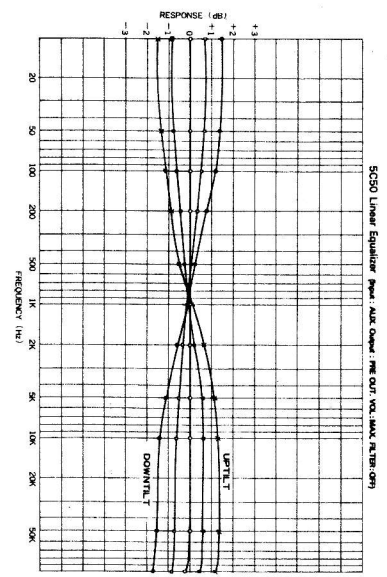
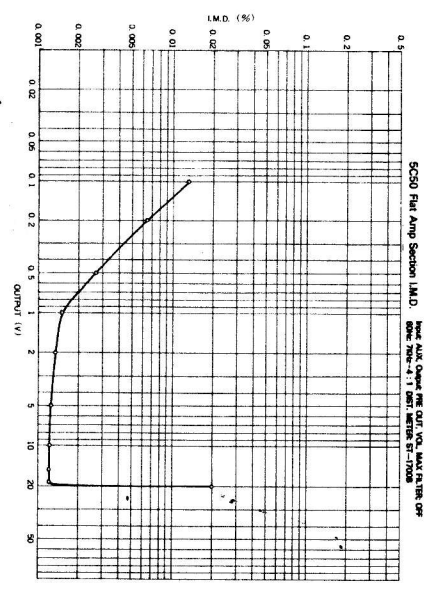
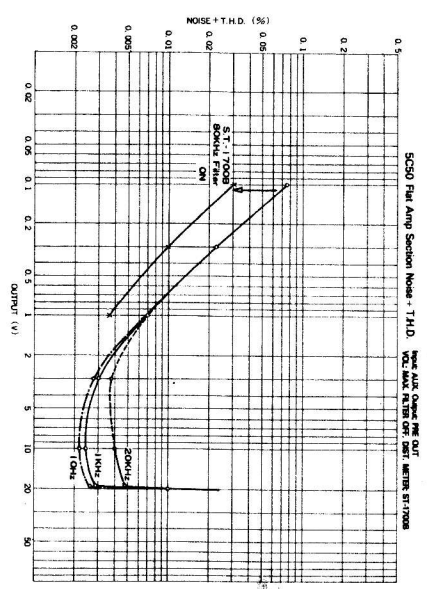

SPECIFICATIONS

- Output Voltage:** pre.out: typical 1V, max: 18V
rec.out: typical 150mV, max: 18V
(distortion: no more than 0.005%)
- Output Impedance:** pre.out 500 ohms
rec.out 500 ohms
- Total Harmonic Distortion:** phono-1 & 2: no more than 0.005%
(rec.out, 2V, 20 - 20KHz)
tuner, aux: no more than 0.005%
(pre.out, 2V, 20 - 20KHz)
monitor-1 & 2: no more than 0.005%
(pre.out, 2V, 20 - 20KHz)
- Rated I.M.D.:** phono-1 & 2: no more than 0.002%
(rec.out, 2V, 50Hz : 7kHz = 4 : 1)
tuner, aux: no more than 0.002%
(pre.out, 2V, 50Hz : 7kHz = 4 : 1)
monitor-1 & 2: no more than 0.002%
- Frequency Response:** phono-1 & 2: no more than 0.002%
(pre.out, 2V, 50Hz : 7kHz = 4 : 1)
tuner, aux: 20Hz ~ 20,000Hz (±0.2dB)
1Hz ~ 200,000Hz (-0.5dB)
phono-1 & 2: 1Hz ~ 200,000Hz (-0.5dB)
monitor-1 & 2: 2.5mV, tuner, aux: 150mV
- Input Sensitivity:** phono-1 & 2: 30K - 50K - 100K ohms (variable)
monitor-1 & 2: 50K ohms
tuner, aux: 50K ohms
- Input Impedance:** phono-1 & 2: 60K ohms
monitor-1 & 2: better than 80dB (IHF A-curve, input short-circuited)
tuner, aux: better than 100dB (IHF A-curve, input short-circuited)
- Signal to Noise Ratio:** monitor-1 & 2: no more than 100dB (IHF A-curve, input short-circuited)
phono-1 & 2: no more than -132dB/V (IHF A-curve, input short-circuited)
tuner, aux: no more than -116.5dB/V (IHF A-curve, input short-circuited)
- Input Converted S/N Ratio:** monitor-1 & 2: no more than -116.5dB/V (IHF A-curve, input short-circuited)
phono-1 & 2: no less than 300mV (1KHz, RMS)
- Phono Overload Voltage:** phono-1 & 2: no more than -80dB (1KHz)
tuner, aux: no more than -95dB (1KHz)
- Crosstalk:** no more than -76dB (10KHz)
- Additional Features:** Linear Equalizer, Subsonic Filter, High Cut Filter, Input Impedance Adjuster, Tape Monitor (dual line), Tape Dubbing, Audio Attenuator, socket for MC Input Transformer, Extra AC outlets.
- Power Consumption:** 15W
- Dimensions:** 442(W) x 400(D) x 101(H)mm (17.13/32 x 15.3/4 x 4")
- Weight:** Net: 8.2kgs, Gross: 10kgs

