

JVC

SERVICE MANUAL

MODEL
JA-S22

DC STEREO INTEGRATED AMPLIFIER

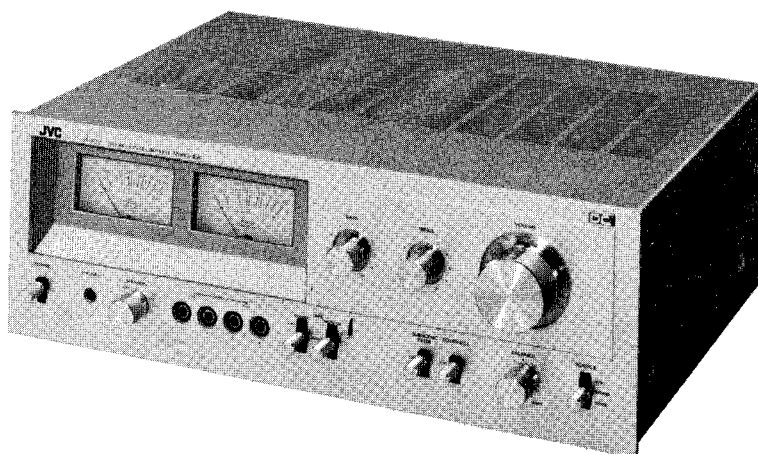

No. 2450
MAR. 1978

Contents

	Page
1. Specifications	2
2. Block Diagram	2
3. Removal of Top Cover and Bottom Plates	3
4. Main Parts Location	4
5. Exploded Views and Part Numbers	
5-(1) Front Panel	5
5-(2) Heat Sink and Power IC's	6
5-(3) Rear Panel	6
6. Adjustment Procedures	
6-(1) Main Amp. Center Voltage	7
6-(2) Idling Current	8
6-(3) Power Meter	8
7. Printed Circuit Board Ass'y and Parts List	
7-(1) TXX-135 Equalizer, Tone Control and Driver Amp. P.C. Board Ass'y	9
7-(2) TXX-136 Power Amp. and Power Supply P.C. Board Ass'y	15
7-(3) TPS-194A AC Outlets and Voltage Selector P.C. Board Ass'y	19
7-(4) TPS-197A Line Voltage Selector P.C. Board Ass'y	19
8. Packing Materials and Part Numbers	20
9. Accessories List	20
10. Parts List with Specified Numbers for Designated Areas	21
11. JA-S22 Schematic Diagram	22

Warning!

When replacing the parts marked with \triangle , be sure to use the designated parts to ensure safety.

Power Specifications

Areas	Line Voltage & Frequency	Power Consumption
U.S.A.	AC 120 V, 60 Hz	182 W
CANADA	AC 120 V, 60 Hz	182 W
EUROPE	AC 220 V \sim , 50 Hz	330 W
U.K. & AUSTRALIA	AC 240 V \sim , 50 Hz	330 W
OTHER AREAS	AC 100/120/220/240 V \sim Selectable, 50/60 Hz	330 W

1. Specifications

CIRCUITRY : DC Power Amplifier

POWER AMPLIFIER SECTION

(measured from AUX INPUT to SPEAKER OUTPUT at Volume maximum.)

Output Power : 40 watts per channel, min. RMS, both channels driven, into 8 ohms, from 20 Hz to 20,000 Hz with no more than 0.02 % total harmonic distortion
 43 watts RMS per channel into 8 ohms (1 kHz, 0.02 % THD)
 50 watts RMS per channel into 4 ohms (1 kHz, 0.05 % THD)

Total Harmonic Distortion (1 kHz) : 0.01 % at 40 watt Output
 0.02 % at 1 watt Output

Intermodulation Distortion : 0.01 % at 40 watt Output
 0.02 % at 1 watt Output

Damping Factor : 30 (20 – 20 kHz, 8 ohms)

Load Impedance : 4 – 16 ohms (SYSTEM 1 or 2)
 8 – 16 ohms (SYSTEM 1 + 2)

PREAMPLIFIER SECTION

Input Sensitivity (Impedance)

PHONO : 2.5 mV (47k ohms)
 TUNER : 160 mV (47k ohms)
 AUX : 160 mV (47k ohms)
 TAPE PLAY : 160 mV (47k ohms) (Tape-1, 2)

Phono Overload Capacity : 200 mV (RMS)

RIAA Phono Equalization : ±0.3 dB (20 – 20 kHz)

Output level

TAPE REC : 160 mV

Signal-to-Noise Ratio (RMS)

PHONO (IHF A Network) : 80 dB
 TUNER, AUX, TAPE PLAY (IHF A Network) : 100 dB

Frequency Response : 5 Hz – 100 kHz (+0, -2 dB)

Tone Controls : Bass 100 Hz ± 8 dB
 Treble 10 kHz ± 8 dB

Subsonic Filter : 6 dB/oct. at 18 Hz

Loudness Control : +6 dB at 100 Hz,
 (-30 dB Volume Control)
 +4 dB at 10 kHz

GENERAL

Power Source : See page 1.

Dimensions (H x W x D) : 149 x 420 x 334 (mm)
 6 x 16-3/4 x 13-3/8 (inches)

Weight (Net) : 8.4 kg (18.5 lbs.)

Design and specifications subject to change without notice.

2. Block Diagram

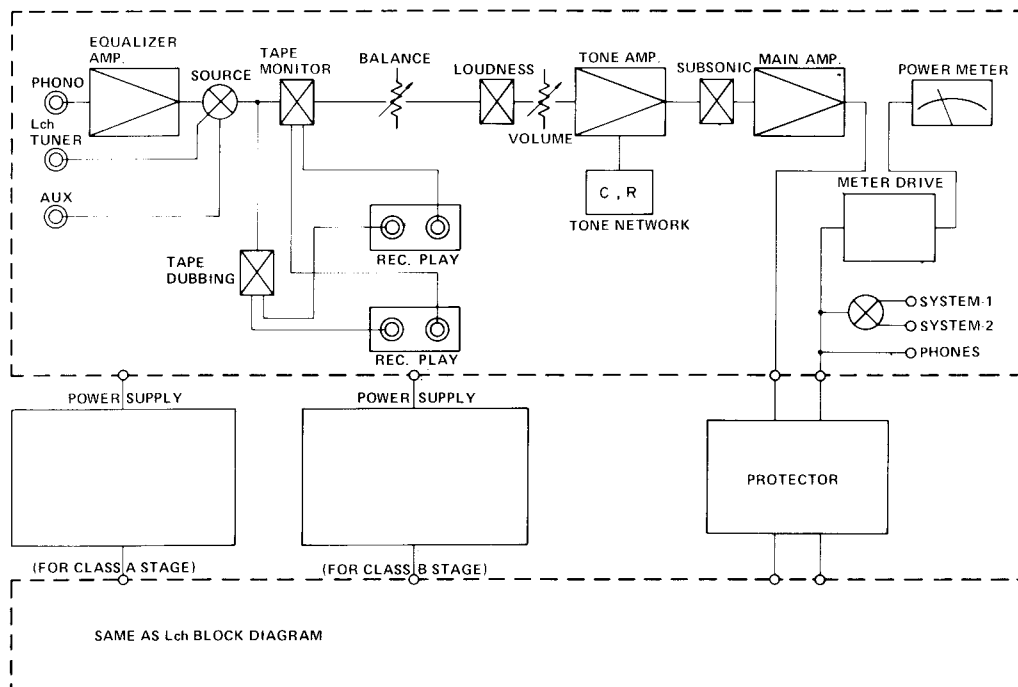

Fig. 1

3. Removal of Top Cover and Bottom Plates

Procedure (Top Cover)

1. Remove 6 screws (Item No. 1) from the top cover (Item No. 2).
2. Remove 2 screws (Item No. 3) from the rear panel back of top cover.

Procedure (Bottom Plate)

1. Remove 2 screws (Item No. 4) from the sub bottom plate (Item No. 5).
2. Remove 7 screws (Item No. 6) from the bottom plate (Item No. 7).

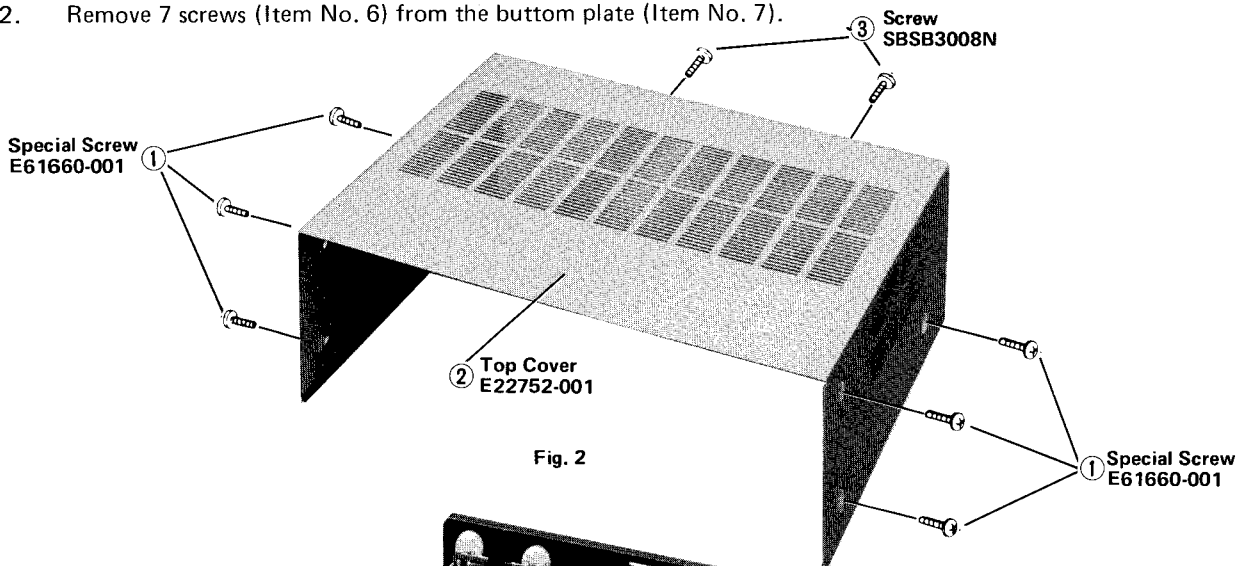

Fig. 2

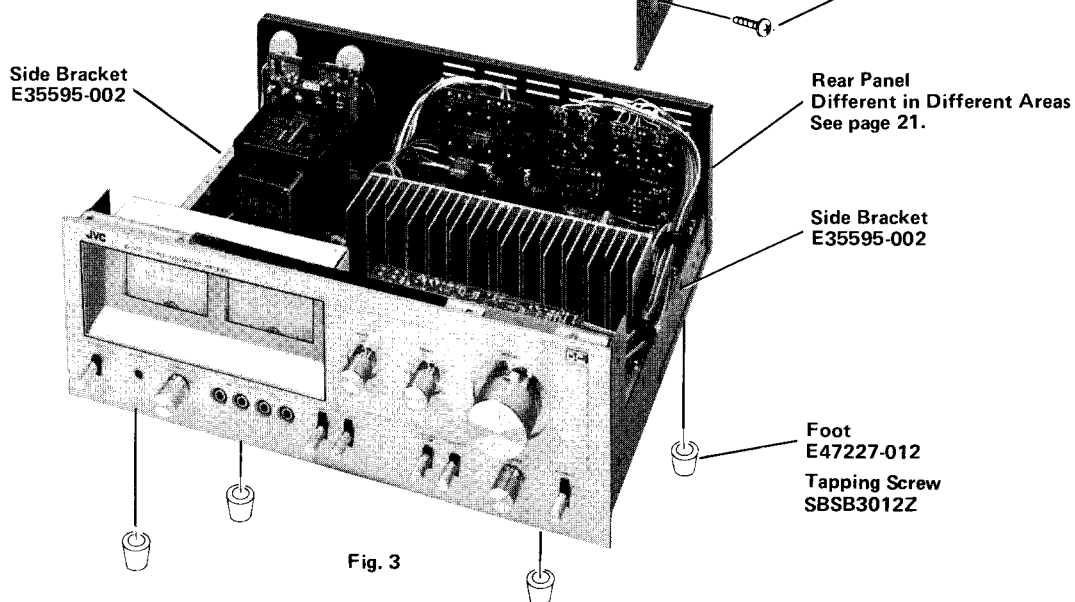

Fig. 3

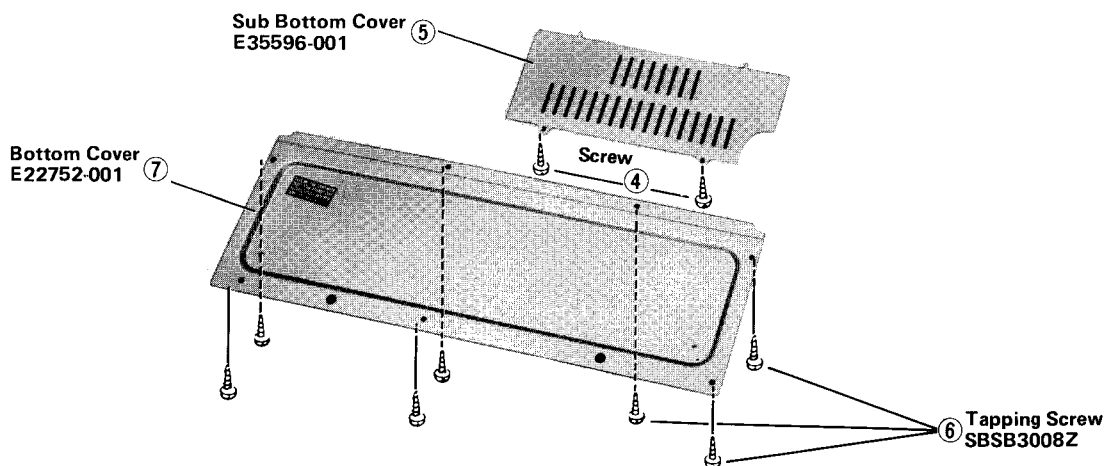

Fig. 4

4. Main Parts Location

Top View

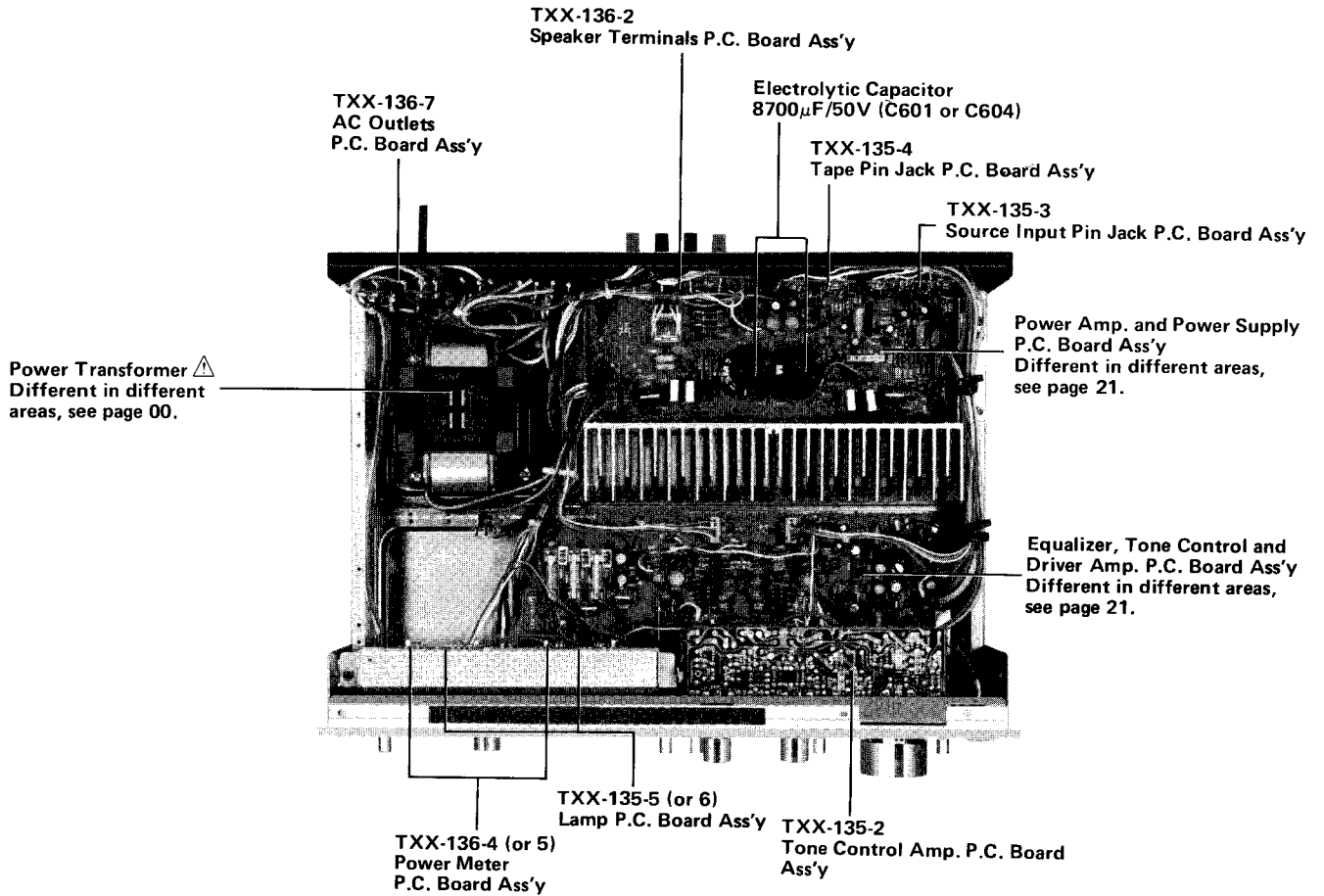

Fig. 5

NOTE: \triangle SAFETY PARTS

Bottom View

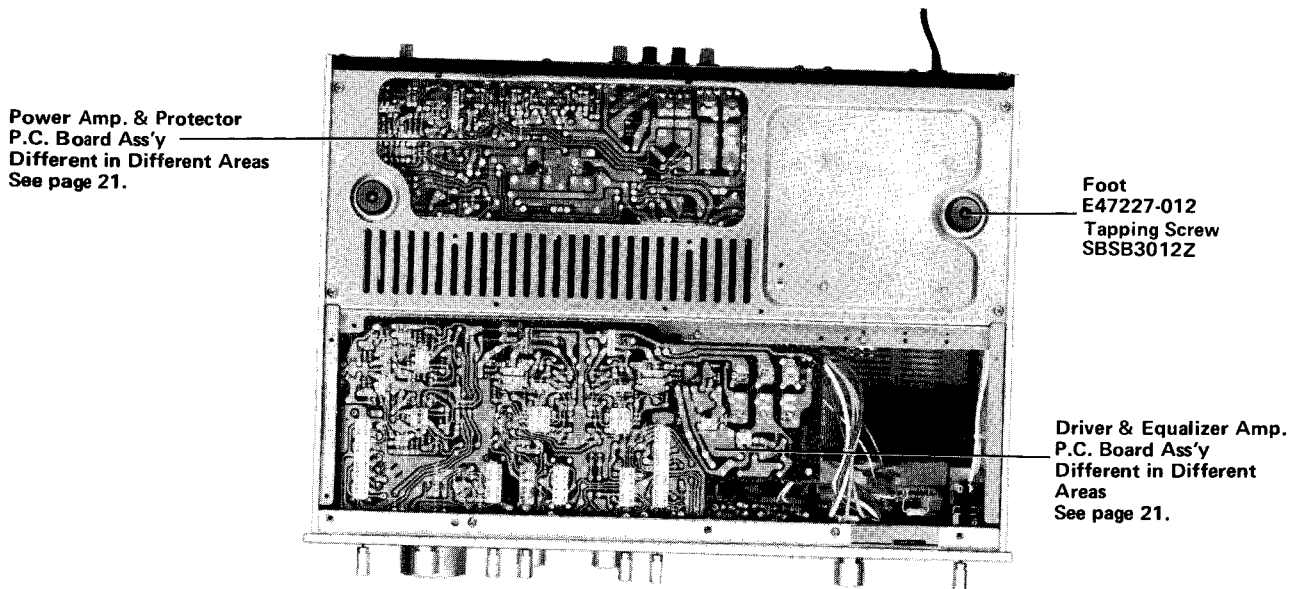

Fig. 6

5. Exploded Views and Part Numbers

5-(1) Front Panel

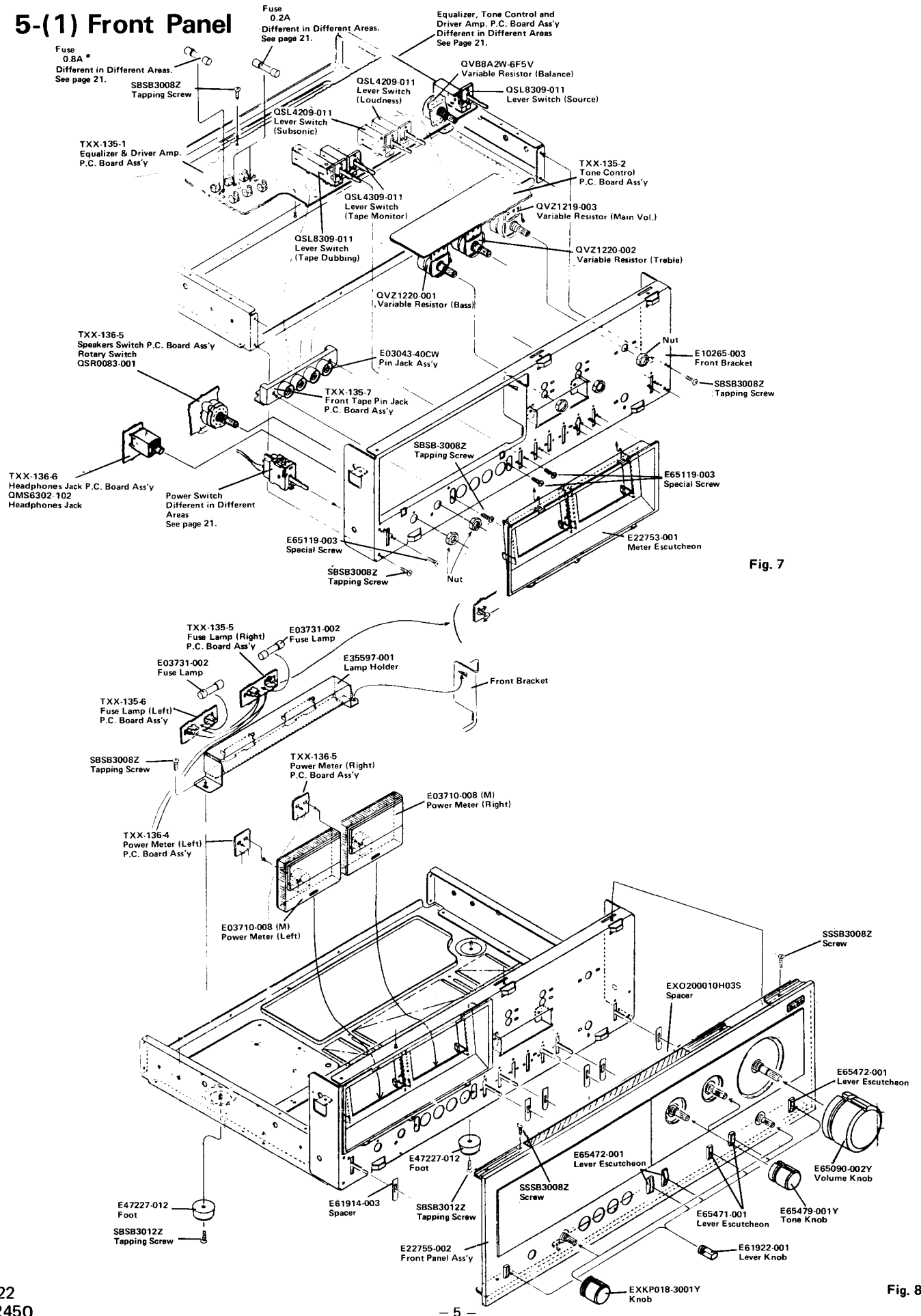

Fig. 7

Fig. 8

5-(2) Heat Sink and Power IC's

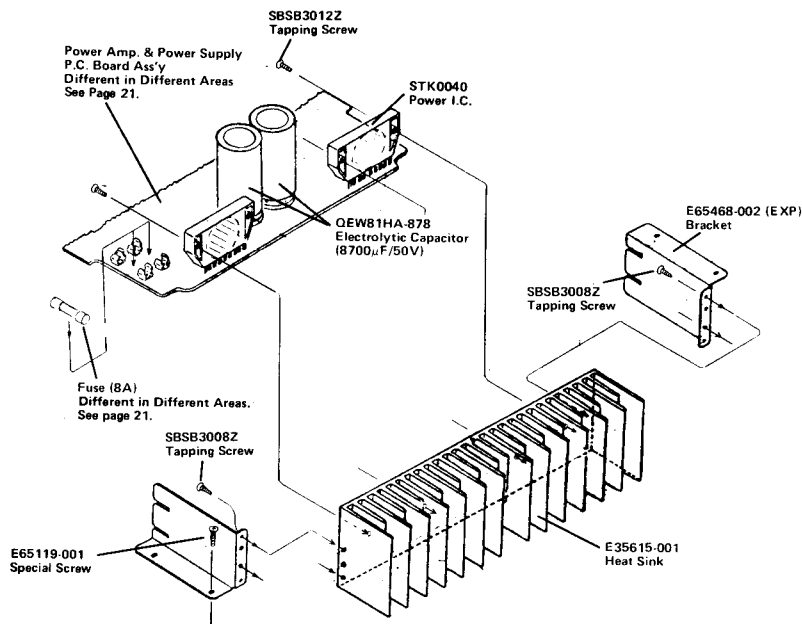

Fig. 9

5-(3) Rear Panel

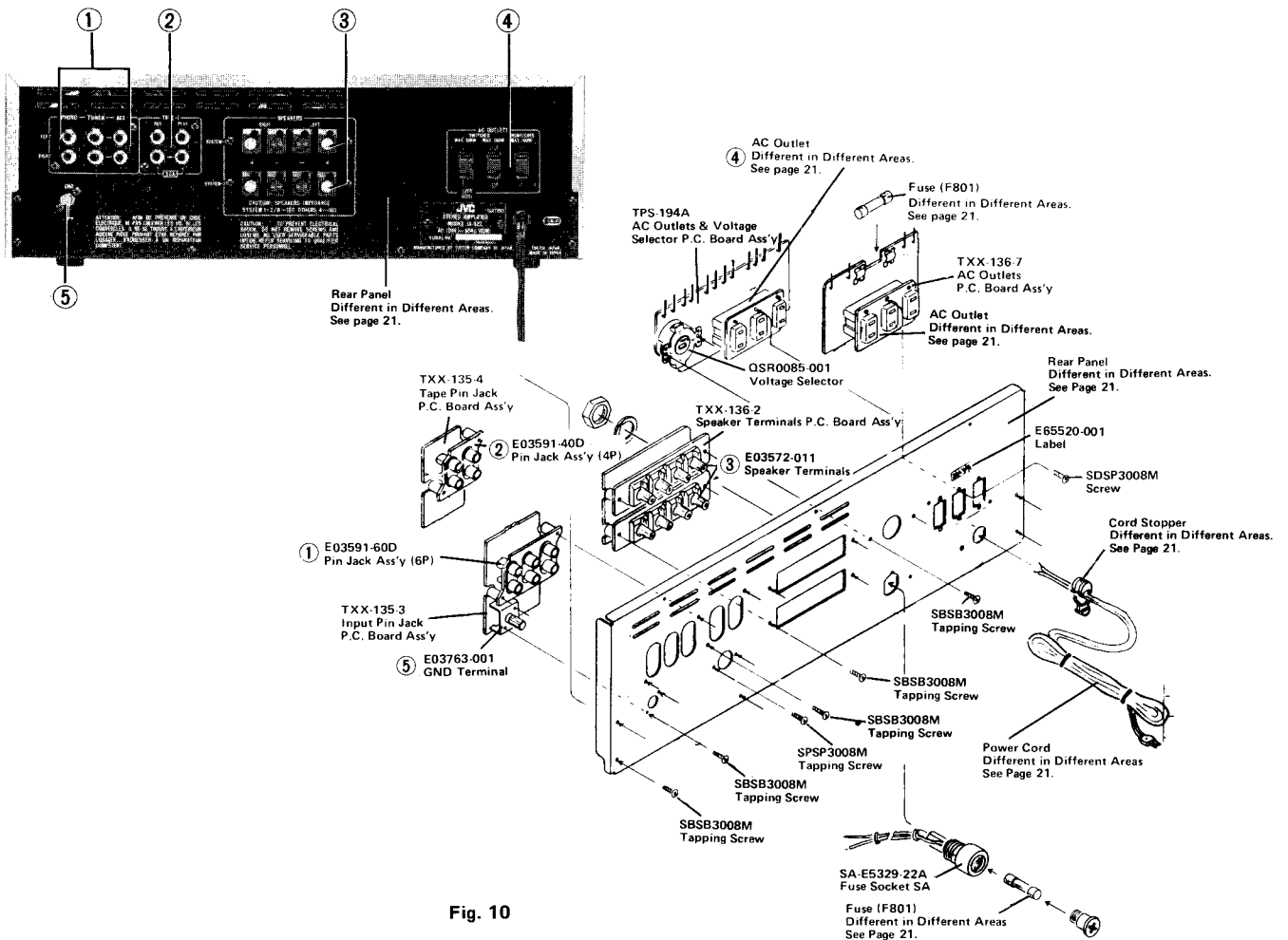
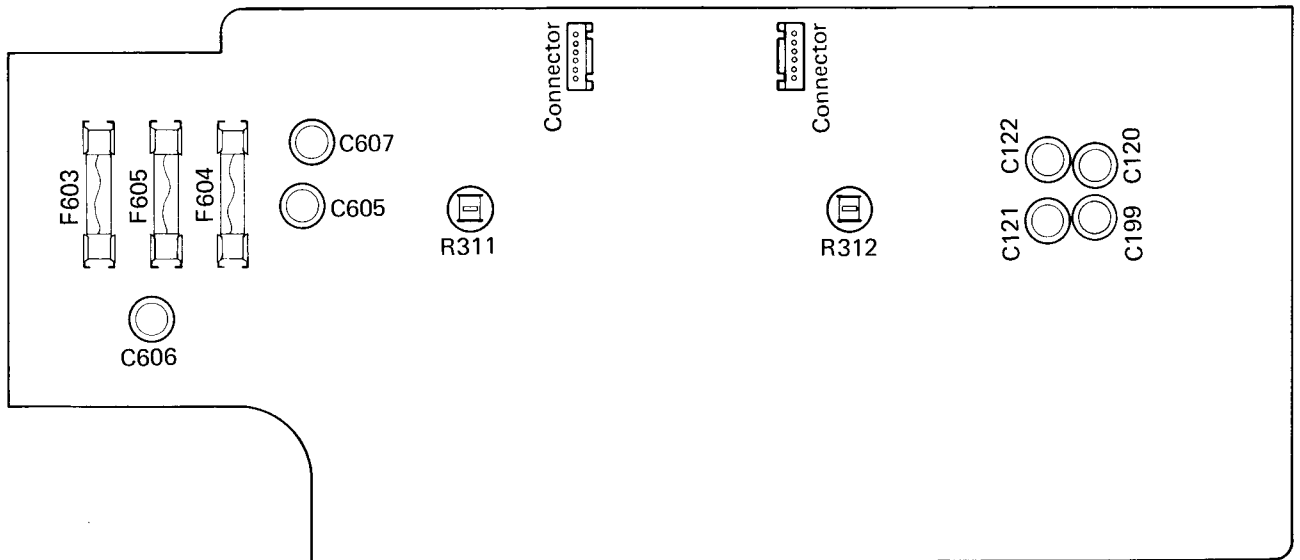

Fig. 10

6. Adjustment Procedures

6-(1) Main Amp. Center Voltage

1. Set the semi-fixed resistors R311 (L channel) and R312 (R channel) located on the Driver & Equalizer Amp. P.C. Board (TXX-135-1) to center position before flipping up the power switch to ON.
2. The measurement points for center voltage exist at test points (T.P.) E and C on the left channel and at C and A on the right channel. However in the event that relay is normally set to ON, it is possible to measure the center voltage at the speaker terminals.
3. Adjust R311 and R312 so that the voltage reading at the measurement points of the above-mentioned is within ± 10 mV. (In the event of the employment of a tester with which it is difficult to read values under 10 mV, adjust them to about 0 V.)



TXX-135-1 Driver & Equalizer Amp. P.C. Board Ass'y

Fig. 11

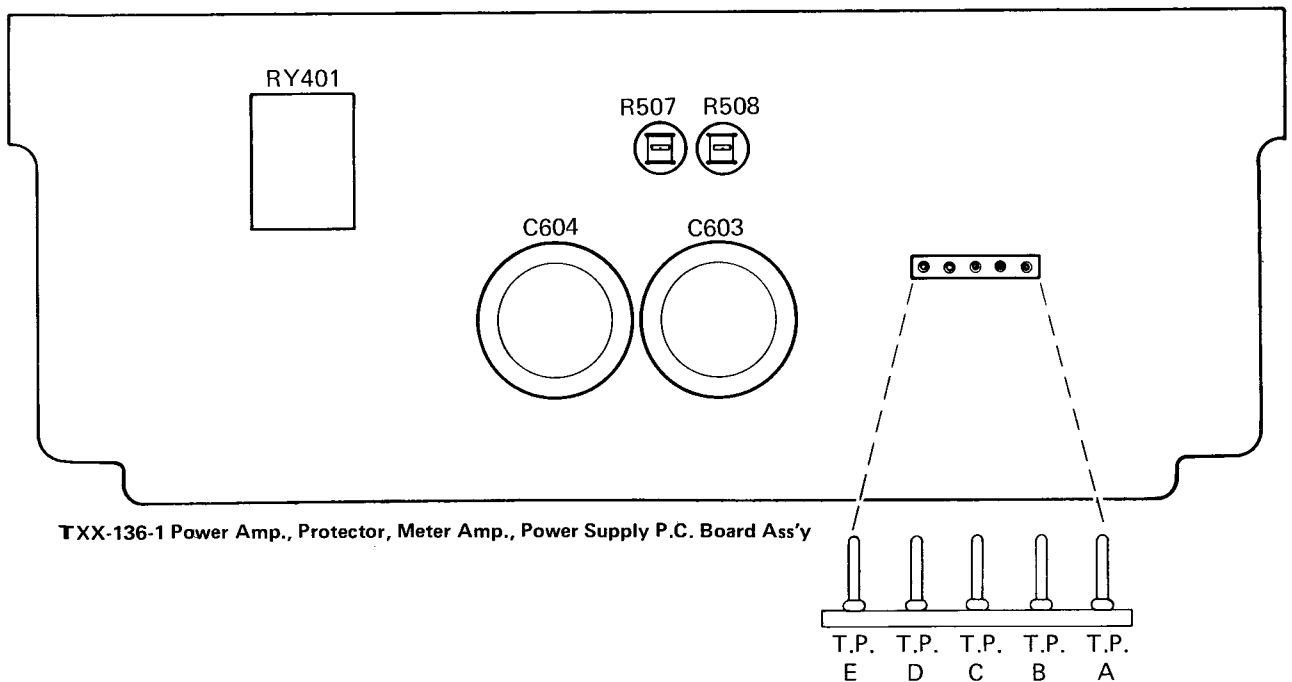

TXX-136-1 Power Amp., Protector, Meter Amp., Power Supply P.C. Board Ass'y

Fig. 12

Adjustment Item	Measurement Points (TXX-136-1)	Adjustment Point (TXX-135-1)	Adjustment Voltage
Power Amplifier Center Voltage Adjustment	L-Channel T.P. E - C R-Channel T.P. C - A	R311 R312	0 mV (within ± 10 mV)

6-(2) Idling Current

This set does not require adjustments due to the employment of ICs. However, checks become necessary in the case of IC replacement and the test points are offered for such an occasion.

1. Connect the DC V.T.V.M., which was used when adjusting the center voltage, to the left channel of T.P. "E" – "D" (or the right channel of T.P. "A" – "B").
2. After the power has been switched on for 2 or 3 minutes, confirm that the DC V.T.V.M. reading is between 6.6 mV and 17.6 mV. If the DC V.T.V.M. reading is out of this range, check the transistors of the driver amplifier.

6-(3) Power Meter

Power Meter Sensitivity Adjustment

For shipment from the factory, sensitivity is adjusted to the most suitable condition. However in the event of a meter replacement or of a severely drifted meter indication, readjust it by the following means:

1. Adjust the output voltage on 8 Ω dummy load so that the reading is 8.94 V (10 W/8 Ω) when injecting a sine wave input of 1 kHz from the terminals AUX.
2. Align the power meter indicator on a value of 10 W by adjusting the semi-fixed resistors R507 (L channel) and R508 (R channel) located on the Power Amp. & Protector P.C. Board (TXX-136-1).

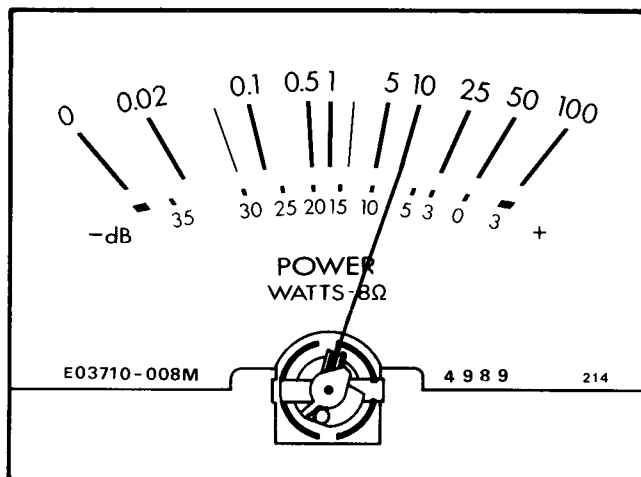

Power Meter (E03710-008M)

Fig. 13

7. Printed Circuit Board Ass'y and Parts List

7-(1) TXX-135 Equalizer, Tone Control and Driver Amp. P.C.Board Ass'y

Note: This number of TXX-135□-1 P.C. Board Ass'y varies according to the areas employed.

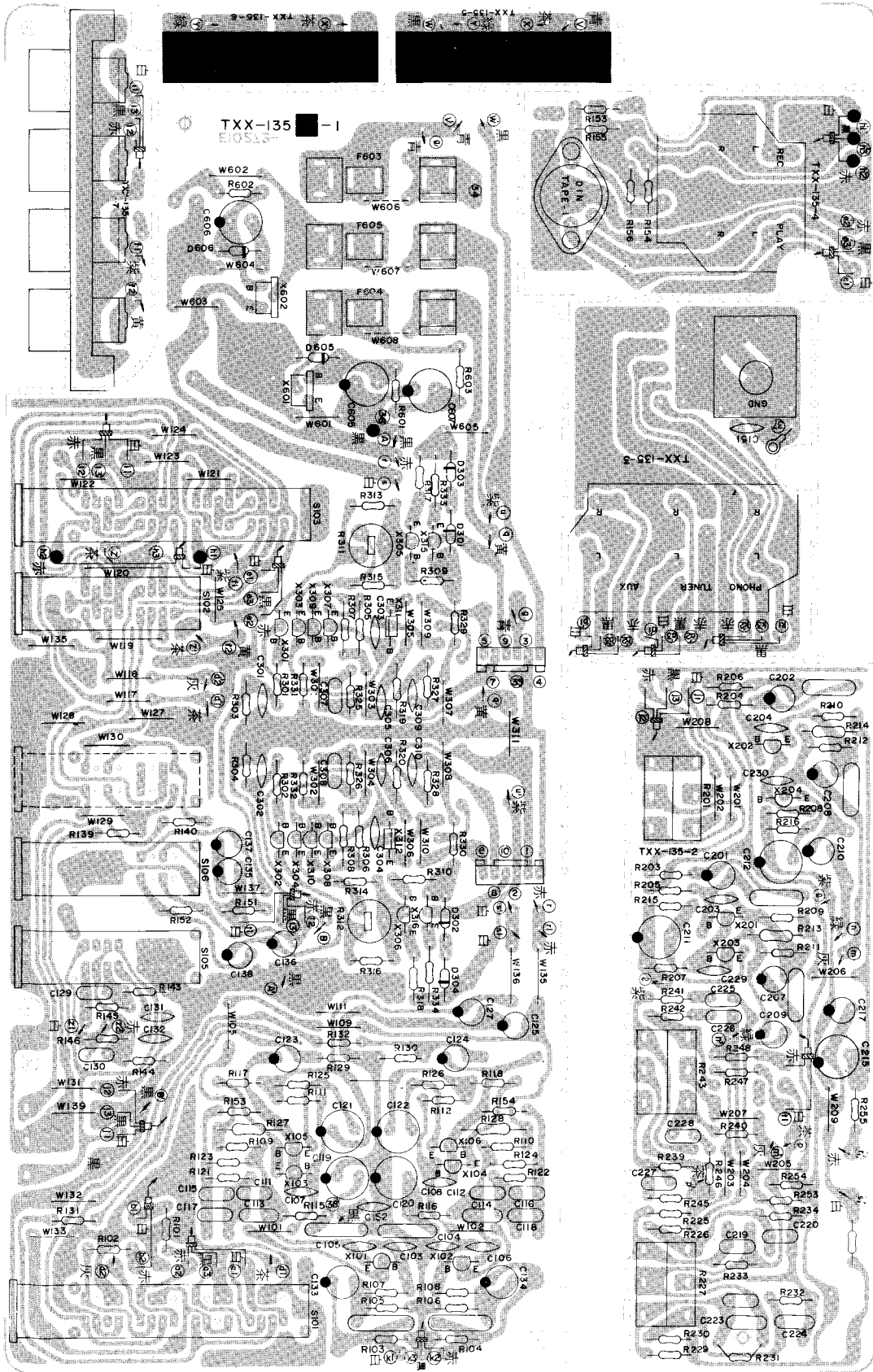

Locations

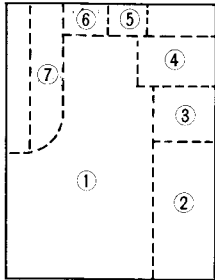

- ① TXX-135□-1 Equalizer and Driver Amp. P.C. Board Ass'y
- ② TXX-135-2 Tone Control P.C. Board Ass'y
- ③ TXX-135-3 Input Pin Jack P.C. Board Ass'y
- ④ TXX-135-4 Tape Pin Jack P.C. Board Ass'y
- ⑤ TXX-135-5 Fuse Lamp (Left) P.C. Board Ass'y
- ⑥ TXX-135-6 Fuse Lamp (Right) P.C. Board Ass'y
- ⑦ TXX-135-7 Front Tape Pin Jack P.C. Board Ass'y

Note: In□ of TXX-135□-1 should be indicated "B", "C", "D" or "E" according to the table shown below:

P.C. Board Ass'y	Designated Areas
TXX-135 [B] -1	U.S.A.
TXX-135 [C] -1	Canada
TXX-135 [D] -1	U.S. Military Market and other countries
TXX-135 [E] -1	Europe and Australia

Transistors

Item No.	Part Number	Rating		Description	Maker
		Pc	fT		
X101	2SA872AV (D, E)	0.3 W	120 MHz	Silicon	Hitachi
X102	2SA872AV (D, E)	"	"	"	"
X103	2SC1775AV (E, F)	"	200 MHz	"	"
X104	2SC1775AV (E, F)	"	"	"	"
X105	2SD438 (D, E)	0.75 W	100 MHz	"	Sanyo
X106	2SD438 (D, E)	"	"	"	"
X201	2SA872AV (E)	0.3 W	120 MHz	"	Hitachi
X202	2SA872AV (E)	"	"	"	"
X203	2SC1775AV (F)	"	200 MHz	"	"
X204	2SC1775AV (F)	"	"	"	"
X301	2SC1775AV (F1)	"	"	"	"
X302	2SC1775AV (F1)	"	"	"	"
X303	2SC1775AV (F1)	"	"	"	"
X304	2SC1775AV (F1)	"	"	"	"
X305	2SC1775AV (E, F)	"	"	"	"
X306	2SC1775AV (E, F)	"	"	"	"
X307	2SA872AV (D, E)	"	120 MHz	"	"
X308	2SA872AV (D, E)	"	"	"	"
X309	2SA872AV (D, E)	"	"	"	"
X310	2SA872AV (D, E)	"	"	"	"
X311	2SA899 (B, V)	1 W	100 MHz	"	Fujitsu
X312	2SA899 (B, V)	"	"	"	"
X315	2SD438 (E)	0.75 W	"	"	NEC
X316	2SD438 (E)	"	"	"	"
X601	2SD330V (E)	20 W	8 MHz	"	Sanyo
X602	2SB514V (E)	"	"	"	"

Diodes

Item No.	Part Number	Rating	Description	Maker
D301	1S2473		Silicon	Toyo Dengu
D302	1S2473		"	"
D303	1S2473		"	"
D304	1S2473		"	"
D605	WZ-260		"	JRC
D606	WZ-260		"	"

Capacitors

Item No.	Part Number	Rating		Description
C103	QCS31HJ-101	100 pF	50 V	Ceramic
C104	QCS31HJ-101	"	"	"
C105	QCS31HJ-101	"	"	"
C106	QCS31HJ-101	"	"	"
C107	QCS31HJ-150	15 pF	"	"
C108	QCS31HJ-150	"	"	"
C111	QFM31HJ-682	6800 pF	"	Mylar
C112	QFM31HJ-682	"	"	"
C113	QFM31HJ-822	8200 pF	"	"
C114	QFM31HJ-822	"	"	"
C115	QFP32AJ-302	3000 pF	100 V	Polypropylene
C116	QFP32AJ-302	"	"	"
C117	QFP32AJ-242	2400 pF	"	"
C118	QFP32AJ-242	"	"	"
C119	QEW50JA-227	220 μ F	6.3 V	Electrolytic
C120	QEW50JA-227	"	"	"
C121	QEW50JA-227	"	"	"
C122	QEW50JA-227	"	"	"
C123	QEB51EM-106	10 μ F	25 V	Low Leak Current Electrolytic
C124	QEB51EM-106	"	"	"
C125	QEW51HA-105	1 μ F	50 V	Electrolytic
C127	QEW51HA-105	"	"	"
C129	QFM31HK-183	0.018 μ F	"	Mylar
C130	QFM31HK-183	"	"	"
C131	QCS31HJ-221	220 pF	"	Ceramic
C132	QCS31HJ-221	"	"	"
C133	QEB51EM-106	10 μ F	25 V	Low Leak Current Electrolytic
C134	QEB51EM-106	"	"	"
C135	QEB51HM-334	0.33 μ F	50 V	"
C136	QEB51HM-334	"	"	"
C137	QEB51EM-225M	2.2 μ F	25 V	"
C138	QEB51EM-225M	"	"	"
C151	QCF31HP-103	0.01 μ F	50 V	Ceramic
C152	QCF31HP-103	"	"	"
C201	QEB51EM-106	10 μ F	25 V	Low Leak Current Electrolytic
C202	QEB51EM-106	"	"	"
C203	QCS31HJ-331	330 pF	50 V	Ceramic
C204	QCS31HJ-331	"	"	"
C207	QEW51HA-225	2.2 μ F	"	Electrolytic
C208	QEW51HA-225	"	"	"

Capacitors

Item No.	Part Number	Rating		Description
C209	QEW51HA-105	1 μ F	50 V	Electrolytic
C210	QEW51HA-105	"	"	"
C211	QEW50JA-227	220 μ F	6.3 V	"
C212	QEW50JA-227	"	"	"
C215	QEW51VA-107	100 μ F	35 V	"
C217	QEW51HA-105	1 μ F	50 V	"
C219	QFM31HJ-223	0.022 μ F	"	Mylar
C220	QFM31HJ-223	"	"	"
C223	QFM31HJ-154	0.15 μ F	"	"
C224	QFM31HJ-154	"	"	"
C225	QFM31HJ-272	2700 pF	"	"
C226	QFM31HJ-272	"	"	"
C227	QFM31HJ-223	0.022 μ F	"	"
C228	QFM31HJ-223	"	"	"
C229	QCS31HJ-150	15 pF	"	Ceramic
C230	QCS31HJ-150	"	"	"
C301	QCS31HJ-331	330 pF	"	"
C302	QCS31HJ-331	"	"	"
C303	QCS31HJ-470	47 pF	"	"
C304	QCS31HJ-470	"	"	"
C305	QCS31HJ-471	470 pF	"	"
C306	QCS31HJ-471	"	"	"
C307	QFM31HK-223	0.022 μ F	"	Mylar
C308	QFM31HK-223	"	"	"
C605	QEW51HA-476	47 μ F	"	Electrolytic
C606	QEW51HA-226	22 μ F	"	"
C607	QEW51HA-226	"	"	"

Resistors

Item No.	Part Number	Rating		Description
R103	QRD141J-104S	100 k Ω	1/4 W	Carbon
R104	QRD141J-104S	"	"	"
R105	QRD141J-104S	"	"	"
R106	QRD141J-104S	"	"	"
R107	QRD141J-101S	100 Ω	"	"
R108	QRD141J-101S	"	"	"
R109	QRD141J-274S	270 k Ω	"	"
R110	QRD141J-274S	"	"	"
R111	QRD141J-473SL	47 k Ω	"	"
R112	QRD141J-473SL	"	"	"
R115	QRD141J-301S	300 Ω	"	"
R116	QRD141J-301S	"	"	"
R117	QRD141J-392S	3.9 k Ω	"	"
R118	QRD141J-392S	"	"	"
R121	QRD141J-153SL	15 k Ω	"	"
R122	QRD141J-153SL	"	"	"
R123	QRD141J-204SL	200 k Ω	"	"
R124	QRD141J-204SL	"	"	"
R125	QRD141J-221S	220 Ω	"	"
R126	QRD141J-221S	"	"	"
R127	QRG017J-222S	2.2 k Ω	1 W	Oxide Metal Film
R128	QRG017J-222S	"	"	"
R129	QRD141J-473S	47 k Ω	1/4 W	Carbon
R130	QRD141J-473S	"	"	"
R131	QRD141J-471S	470 Ω	"	"

Resistors

Item No.	Part Number	Rating		Description
R132	QRD141J-471S	470 Ω	1/4 W	Carbon
R139	QRD141J-472S	4.7 k Ω	"	"
R140	QRD141J-472S	"	"	"
R141	QVB8A2W-6F5V	250 k Ω	1/2 W	Variable (Carbon)
R143	QRD141J-223S	22 k Ω	1/4 W	Carbon
R144	QRD141J-223S	"	"	"
R145	QRD141J-683S	68 k Ω	"	"
R146	QRD141J-683S	"	"	"
R151	QRD141J-105S	1 M Ω	"	"
R152	QRD141J-105S	"	"	"
R157	QRD141J-334S	330 k Ω	"	"
R158	QRD141J-334S	"	"	"
R155	QRD141J-104S	100 k Ω	"	"
R156	QRD141J-104S	"	"	"
R201	QVZ1219-005	250 k Ω	1/2 W	Variable (Carbon)
R203	QRD141J-471S	470 Ω	1/4 W	Carbon
R204	QRD141J-471S	"	"	"
R205	QRD141J-224S	220 k Ω	"	"
R206	QRD141J-224S	"	"	"
R207	QRD141J-223S	22 k Ω	1/4 W	"
R208	QRD141J-223S	"	"	"
R209	QRD141J-204S	200 k Ω	"	"
R210	QRD141J-204S	"	"	"
R211	QRD141J-224S	220 k Ω	"	"
R212	QRD141J-224S	"	"	"
R213	QRD126J-822	8.2 k Ω	1/2 W	"
R214	QRD126J-822	"	"	"
R215	QRD141J-391S	390 Ω	1/4 W	"
R216	QRD141J-391S	"	"	"
R225	QRD141J-203S	20 k Ω	"	"
R226	QRD141J-203S	"	"	"
R227	QVZ1220-001	100 k Ω	1/2 W	Variable (Carbon) Bass
R229	QRD141J-302S	3 k Ω	1/4 W	Carbon
R230	QRD141J-302S	"	"	"
R231	QRD141J-243S	24 k Ω	"	"
R232	QRD141J-243S	"	"	"
R233	QRD141J-204S	200 k Ω	"	"
R234	QRD141J-204S	"	"	"
R239	QRD141J-823S	82 k Ω	"	"
R240	QRD141J-823S	"	"	"
R241	QRD141J-472S	4.7 k Ω	"	"
R242	QRD141J-472S	"	"	"
R243	QVZ1220-002	100 k Ω	1/2 W	Variable (Carbon) Treble
R245	QRD141J-911S	910 Ω	1/4 W	Carbon
R246	QRD141J-911S	"	"	"
R247	QRD141J-471S	470 Ω	"	"
R248	QRD141J-471S	"	"	"
R253	QRD141J-363S	36 k Ω	"	"
R254	QRD141J-363S	"	"	"
R255	QRD141J-561S	560 Ω	"	"
R301	QRD141J-271S	270 Ω	"	"
R302	QRD141J-271S	"	"	"
R303	QRD141J-243S	24 k Ω	"	"
R304	QRD141J-243S	"	"	"
R305	QRD126J-101	100 Ω	1/2 W	"

Resistors

Item No.	Part Number	Rating		Description
R306	QRD126J-101	100 Ω	1/2 W	Carbon
R307	QRD126J-101	"	"	"
R308	QRD126J-101	"	"	"
R309	QRD149J-680S	68 Ω	1/4 W	"
R310	QRD149J-680S	"	"	"
R311	QVP4A0B-221	220 Ω	0.15 W	Variable (Carbon)
R312	QVP4A0B-221	"	"	"
R313	QRD141J-470S	47 Ω	1/4 W	Carbon
R314	QRD141J-470S	"	"	"
R315	QRD141J-470S	"	"	"
R316	QRD141J-470S	"	"	"
R317	QRD141J-391S	390 Ω	"	"
R318	QRD141J-391S	"	"	"
R319	QRD126J-271	270 Ω	1/2 W	"
R320	QRD126J-271	"	"	"
R325	QRD141J-243S	24 k Ω	1/4 W	"
R326	QRD141J-243S	"	"	"
R327	QRD141J-113S	11 k Ω	"	"
R328	QRD141J-113S	"	"	"
R329	QRD141J-273S	27 k Ω	"	"
R330	QRD141J-273S	"	"	"
R331	QRD149J-681S	680 Ω	"	"
R332	QRD149J-681S	"	"	"
R333	QRD126J-121	120 Ω	1/2 W	"
R334	QRD126J-121	"	"	"
R601	QRD141J-332S	3.3 k Ω	1/4 W	"
R602	QRD141J-682S	6.8 k Ω	"	"
R603	QRD126J-332	3.3 k Ω	1/2 W	"

Others

Item No.	Part Number	Rating		Description
	E03591-40D			Pin Jack Ass'y
	E03591-60D			"
	See page 21			Din Socket
	E10272-001			Circuit Board (TXX-135)
	See page 21			Contact Clip
	52868-4			Lug
S101	QSL8309-011			Lever Switch
S102	QSL4309-011			"
S103	QSL8309-011			"
S105	QSL4209-011			"
S106	QSL4209-011			"
6PIN	E03732-006A			Plug (6 Pin)
	See page 21			Fuse Label
TAPE 2	E03043-40CW			Front Pin Jack Ass'y

7-(2) TXX-136 Power Amp. and Power Supply P.C.Board Ass'y

Note: This number of TXX-136□-1 P.C. Board Ass'y varies according to the area employed.

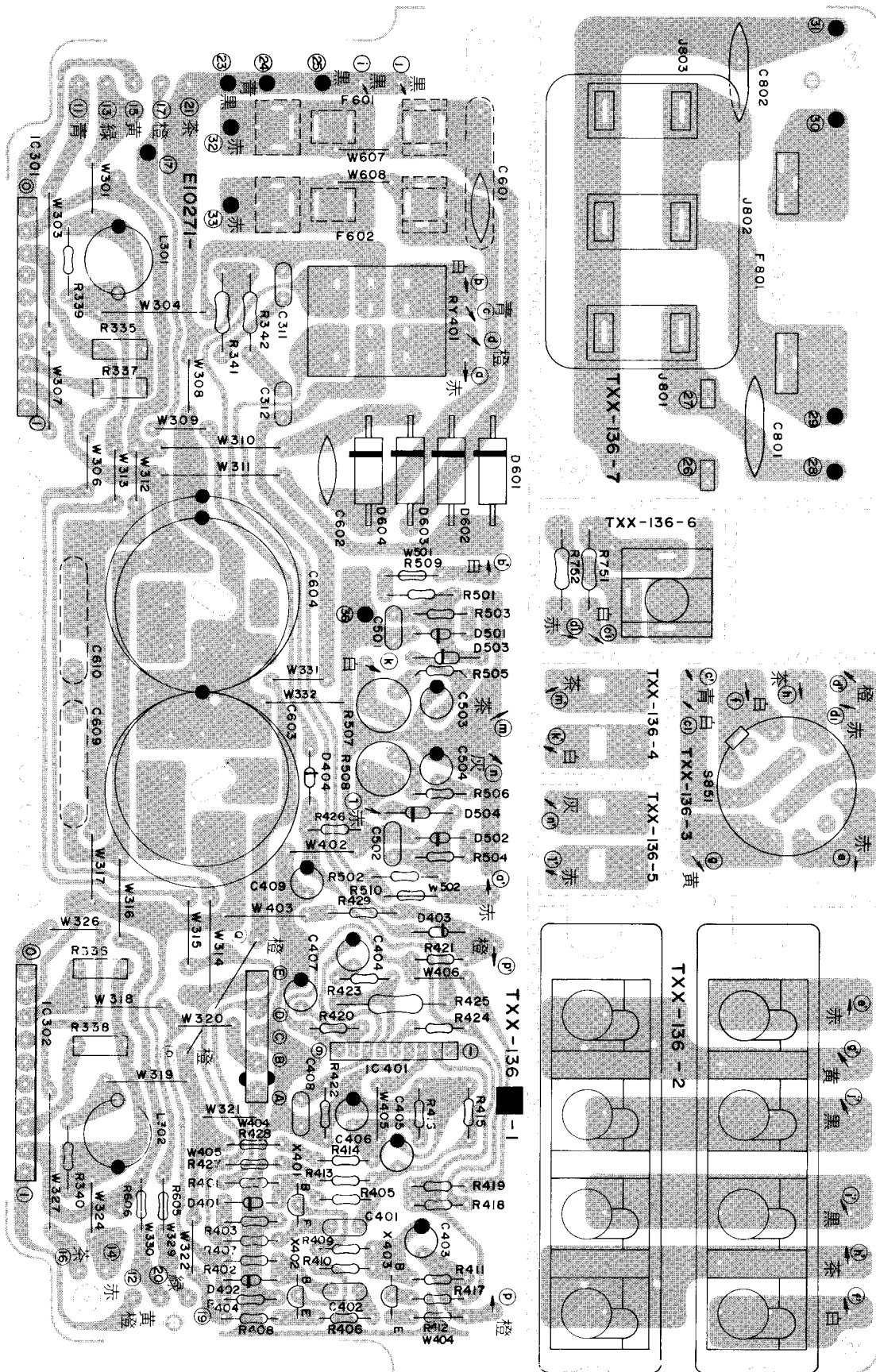

Locations

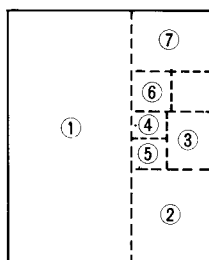

- ① TXX-136□-1 Power Amp./Power Supply P.C. Board Ass'y
- ② TXX-136-2 Speaker Terminals P.C. Board Ass'y
- ③ TXX-136-3 Speakers Switch P.C. Board Ass'y
- ④ TXX-136-4 Power Meter (Left) P.C. Board Ass'y
- ⑤ TXX-136-5 Power Meter (Right) P.C. Board Ass'y
- ⑥ TXX-136-6 Headphones Jack P.C. Board Ass'y
- ⑦ TXX-136-7 AC Outlets P.C. Board Ass'y

Note: In □ of TXX-136□-1 should be indicated "B", "C", "D" or "E" according to the table shown below:

P.C. Board Ass'y	Designated Areas
TXX-136 B -1	U.S.A.
TXX-136 C -1	Canada
TXX-136 D -1	U.S. Military Market and other countries
TXX-136 E -1	Europe and Australia

Transistors

Item No.	Part Number	Rating		Description	Maker
		Pc	fT		
X401	2SC1775AV (E, F)	0.3 W	200 MHz	Silicon	Hitachi
X402	2SC1775AV (E, F)	"	"	"	"
X403	2SA872AV (D, E)	"	120 MHz	"	"

Integrated Circuits

Item No.	Part Number	Rating		Description	Maker
		Pc			
IC301	STK0040	0.5 W		I.C.	Sanyo
IC302	STK0040				"
IC401	TA7317P				Toshiba

Diodes

Item No.	Part Number	Rating	Description	Maker
D401	1S2473		Silicon	Toyo Dengu
D402	1S2473		"	
D403	1S2473		"	
D404	1S2473		"	
D501	1S2076-32		"	Hitachi
D502	1S2076-32		"	"
D503	1S188FM		Germanium	Sanyo
D504	1S188FM		"	"
D601	30D2FA-S		Silicon	Japan International Rectifier
D602	30D2FA-S		"	"
D603	30D2FA-S	"	"	
D604	30D2FA-S	"	"	

Coils

Item No.	Part Number	Rating	Description
L301	E04059-1R0		Choke Coil
L302	E04059-1R0		"

Capacitors

Item No.	Part Number	Rating	Description	
C311	QFM31HK-104	0.1 μ F	50 V	Mylar
C312	QFM31HK-104	"	"	"
C401	QFM31HK-104	"	"	"
C402	QFM31HK-104	"	"	"
C403	QEW51CA-226	22 μ F	16 V	Electrolytic
C404	QEW51HA-474	0.47 μ F	50 V	"
C405	QEW51AA-476	47 μ F	10 V	"
C406	QEW51AA-476	"	"	"
C407	QEW51CA-226	22 μ F	16 V	"
C408	QFM31HK-153	0.015 μ F	50 V	Mylar
C409	QEW51EA-475	4.7 μ F	25 V	Electrolytic
C501	QFM31HK-223	0.022 μ F	50 V	Mylar
C502	QFM31HK-223	"	"	"
C503	QEW51AA-476	47 μ F	10 V	Electrolytic
C504	QEW51AA-476	"	"	"
C601	QCF12HP-103	0.01 μ F	500 V	Ceramic
C602	QCF12HP-103	"	"	"
C603	QEW81HA-878		50 V	Electrolytic
C604	QEW81HA-878		"	"
C801	QCZ9013-103	0.01 μ F	AC 125 V	Ceramic (for U.S.A. and Canada)
C802	QCZ9013-103	"	"	" (for U.S.A. and Canada)

Resistors

Item No.	Part Number	Rating	Description	
R335	QRM054K-R22	0.22 Ω	5 W	Metal Plate
R336	QRM054K-R22	"	"	"
R337	QRM054K-R22	"	"	"
R338	QRM054K-R22	"	"	"
R339	QRX129J-4R7	4.7 Ω	1/2 W	Oxide Metal Film
R340	QRX129J-4R7	"	"	"
R341	QRX017J-6R8S	6.8 Ω	1 W	"
R342	QRX017J-6R8S	"	"	"
R401	QRD149J-681S	680 Ω	1/4 W	Carbon
R402	QRD149J-681S	"	"	"
R403	QRD141J-562S	5.6 k Ω	"	"
R404	QRD141J-562S	"	"	"
R405	QRD141J-101S	100 Ω	"	"
R406	QRD141J-101S	"	"	"
R407	QRD149J-471S	470 Ω	"	"
R408	QRD149J-471S	"	"	"
R409	QRD141J-123S	12 k Ω	"	"
R410	QRD141J-123S	"	"	"
R411	QRD141J-103S	10 k Ω	"	"
R413	QRD141J-563S	56 k Ω	"	"

Resistors

Item No.	Part Number	Rating		Description
R414	QRD141J-563S	56 kΩ	1/4 W	Carbon
R415	QRD141J-273S	27 kΩ	"	"
R416	QRD141J-273S	"	"	"
R417	QRD141J-473S	47 kΩ	"	"
R418	QRD141J-124S	120 kΩ	"	"
R419	QRD141J-683S	68 kΩ	"	"
R420	QRD141J-204S	200 kΩ	"	"
R421	QRD141J-183S	18 kΩ	"	"
R422	QRD141J-333S	33 kΩ	"	"
R423	QRD141J-563S	56 kΩ	"	"
R424	QRD141J-332S	3.3 kΩ	"	"
R425	QRG027J-331	330 Ω	2 W	Oxide Metal Film
R426	QRD126J-270	27 Ω	1/2 W	Carbon
R426	QRD141J-223S	22 kΩ	1/4 W	"
R427	QRD149J-680S	68 Ω	"	"
R428	QRD149J-680S	"	"	"
R501	QRD126J-821	820 Ω	1/2 W	"
R502	QRD126J-821	"	"	"
R503	QRD141J-220S	22 Ω	1/4 W	"
R504	QRD141J-220S	"	"	"
R505	QRD141J-681S	680 Ω	"	"
R506	QRD141J-681S	"	"	"
R507	QVP4A0B-222	2.2 kΩ	0.15 W	Variable (Carbon)
R508	QVP4A0B-222	"	"	"
R509	QRD149J-680S	68 Ω	1/4 W	Carbon
R510	QRD149J-680S	"	"	"
R605	QRD149J-5R6S	5.6 Ω	"	"
R606	QRD149J-5R6S	"	"	"
R751	QRG017J-221S	220 Ω	1 W	Oxide Metal Film
R752	QRG017J-221S	"	"	"

Others

Item No.	Part Number	Rating		Description
	E03572-011			Speaker Terminal
	E03628-5UD			5 Pin Plug
	E03675-003			Fuse Clip
	E03675-003			"
	E10271-001			Circuit Board (TXX-136)
	E43727-001			Tab
	E43727-001			"
	E45524-001			Fuse Clip
	E48965-002			"
	QMC0637-001			AC Outlet
	QMC0637-001			"
	QMS6302-102			Headphones Jack
5	E03733-0605			SKT. Wire Ass'y
6	E03733-0604			"
	See page 21.			Fuse Label
RY401	ESK6D24-211			Relay

7-(3) TPS-194A AC Outlets and Voltage Selector P.C.Board Ass'y

[Employed only on (U), (P) and (F) types, replacing the TXX-136-7 of (J) and (C) types]

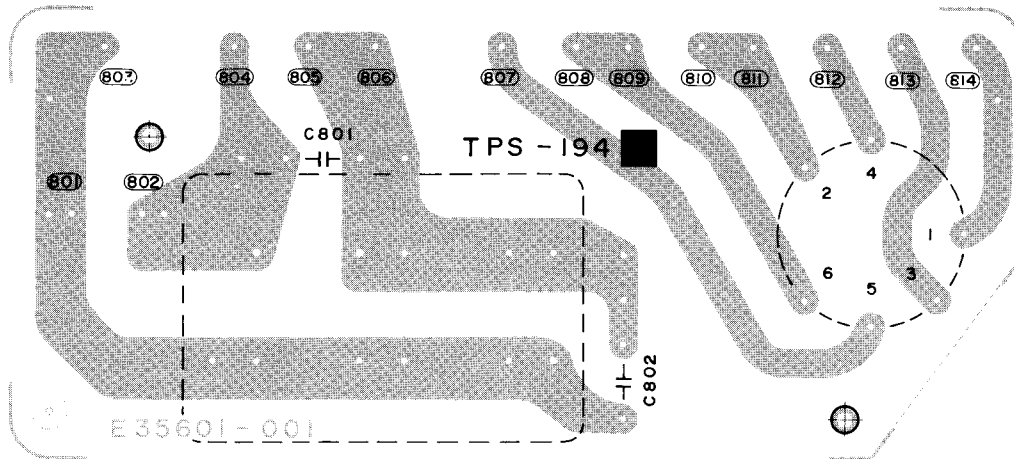

Fig. 16

Capacitors

Item No.	Part Number	Rating	Description
C801	QFH53AM-103	0.01 μ F	Switch By-pass
C802	QFH53AM-103	"	Line to Line

Others

Item No.	Part Number	Rating	Description
	OMC0637-002		AC Outlet Ass'y
	QSR0085-001		Line Voltage Selector Selectable 110 V, 120 V, 220 V, 240 V

7-(4) TPS-197A Line Voltage Selector P.C.Board Ass'y

[Employed only on (E), (A) and (BS) types replacing the TXX-136-7 of (J) and (C) types]

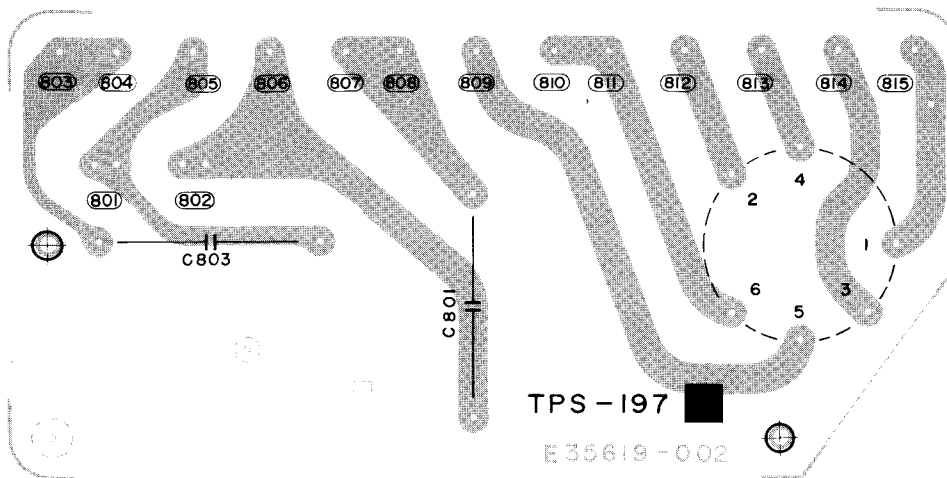

Notes:

- (A) : Australia
- (BS) : U.K.
- (C) : Canada
- (E) : Continental Europe
- (F) : Military Market in Europe
- (J) : U.S.A.
- (P) : Military Market in Asia
- (U) : Other Countries

Fig. 17

Others

Item No.	Part Number	Rating	Description
	QSR0085-001		Line Voltage Selector Selectable 110 V, 120 V, 220 V, 240 V

8. Packing Materials and Part Numbers

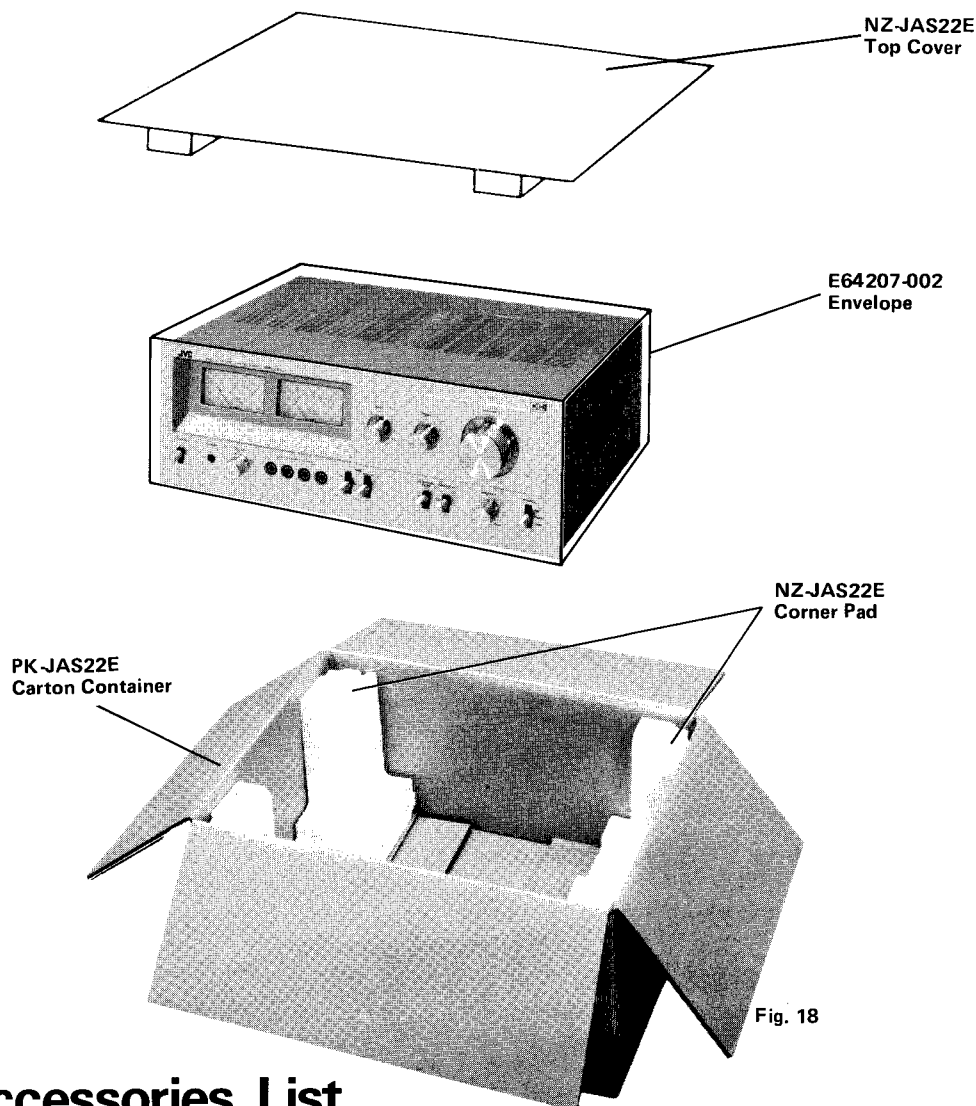

9. Accessories List

Item No.	Part Number	Description	Q'ty
1	E30580-648A	Instruction Book	1
2	See below	Warranty Card	1
3	E64207-002	Envelope for Instruction Book and Warranty Card	1
4	BT20024B	"Do It Better" (for U.S.A. only)	1
5	BT20023	Service Procedures (for U.S.A. only)	1
6	QMF60R1-3R3 (See page 21.)	Fuse (for U.S. Military Market and Others)△	1
7	E64208-001	Envelope for Fuses (for U.S. Military Market and Others)	1
8	E7958-D	Fuse Label (U.S. Military Market and Others)	1
9	E64216-002	Caution Tag (with Power Cord for Military Market only)	1

NOTE: △ SAFETY PARTS

Warranty Card

U.S.A.	Canada	U.S. Military Market	Europe	Australia	U.K.
BT20032	BT20025B	BT20032	—	BT20029	BT20013B

10. Parts List with Specified Numbers for Designated Areas

Page	Item No.	Description	U.S.A.	Canada	U.S.Military Market & Other Countries	Europe	Australia	U.K.
5		Power Switch Δ	QSL2214-002	QSL2214-002	QSL2214-002	QSL2214-004	QSL2214-004	QSL2214-004BS
6		Power Cord with Plug Δ	QMP1200-244	QMP1200-244	QMP1200-244	QMP3910-244	QMP2610-200	QMP9017-008BS
6		Cord Stopper Δ	QHS3876-162	QHS3876-162	QHS3876-162	QHS3876-162	QHS3876-162	QHS3876-162BS
4		Power Trans- former Δ	E03077-32B	E03077-32B	E03077-32C	E03077-32C	E03077-32C	E03077-32CBS
6		Fuse Δ (Primary)	QMF61U1-3R0 (3.0 A)	QMF60R1-3R3 (3.3 A)	QMF60R1-3R3 (3.3 A)	QMF51A2-1R6 (1.6 AT)	QMF51A2-1R6 (1.6 AT)	QMF51A2-1R6BS (1.6 AT)
6		Fuse Δ (Secondary)	—	QMF60R1-8R0 (8.0 A)	—	QMF51A2-8R0 (8.0 AT)	QMF51A2-8R0 (8.0 AT)	QMF51A2-8R0BS (8.0 AT)
5		Fuse Δ (Secondary)	QMF61U1-R80 (0.8 A)	QMF60R1-R80 (0.8 A)	QMF60R1-R80 (0.8 A)	QMF51A2-R80 (0.8 A)	QMF51A2-R80 (0.8 AT)	QMF51A2-R80BS (0.8 AT)
5		Fuse Δ (Secondary)	QMF61M2-R20 (0.2 A)	QMF60R1-R20 (0.2 A)	QMF60R1-R20 (0.2 A)	QMF51A2-R20 (0.2 AT)	QMF51A2-R20 (0.2 AT)	QMF51A2-R20BS (0.2 AT)
6		AC Outlet Δ	QMC0637-001	QMC0637-001	QMC0637-002	—	—	—
6		Voltage Selector Δ	—	—	QSR0085-001	QSR0085-001	QSR0085-001	QSR0085-001BS
6		Rear Panel	E22746-003	E22746-003	E22746-002	E22746-002	E22746-002	E22746-002
19	7-(3), (4)	AC Outlet or Voltage Selec- tor P.C. Board Ass'y Δ	TXX-136B-7	TXX-136C-7	TPS-194A	TPS-197A	TPS-197A	TPS-19BBS
9	7-(1)	Diver Amp. P.C. Board Ass'y	TXX-135B	TXX-135C	TXX-135D	TXX-135E	TXX-135E	TXX-135E
13	R157, R158	Carbon Resis- tor	—	—	QRD141J-334S (330k Ω , 1/4W)	QRD141J-334S (330k Ω , 1/4W)	QRD141J-334S (330k Ω , 1/4W)	QRD141J-334S (330k Ω , 1/4W)
13	R155, R156	Carbon Resis- tor	—	—	QRD141J-104S (100k Ω , 1/4W)	QRD141J-104S (100k Ω , 1/4W)	QRD141J-104S (100k Ω , 1/4W)	QRD141J-104S (100k Ω , 1/4W)
14		DIN Terminal Fuse Socket	—	—	E03623-002	E03623-002	E03623-002	E03623-002
15		Fuse Clip	E03675-003	E03675-003	—	—	—	—
9, 15			E45524-001	E45524-001	E45524-001	E48965-002	E48965-002	E48965-002
15		Fuse Label	E61380-025	E61380-006	E65521-003	E65521-004	E65521-004	E65521-004
15			—	E61380-020	—	E61381-019	E61381-019	E61381-019
			E61380-016	E61380-021	E61382-011	E61381-013	E61381-013	E61381-013
			E61380-002	E61380-002	E61382-002	E61381-017	E61381-017	E61381-017
15	7-(2)	Power Supply P.C. Board Ass'y	TXX-136B	TXX-136C	TXX-136D	TXX-136E	TXX-136E	TXX-136E
15, 19		Mask Plate Capacitor	—	—	—	E65494-001	E65494-001	E65494-001
			QCZ9013-103	QCZ9013-103	QFH53AM-103	—	—	—

NOTE: Δ SAFETY PARTS

JA-S22 Schematic Diagram

A

B

C

D

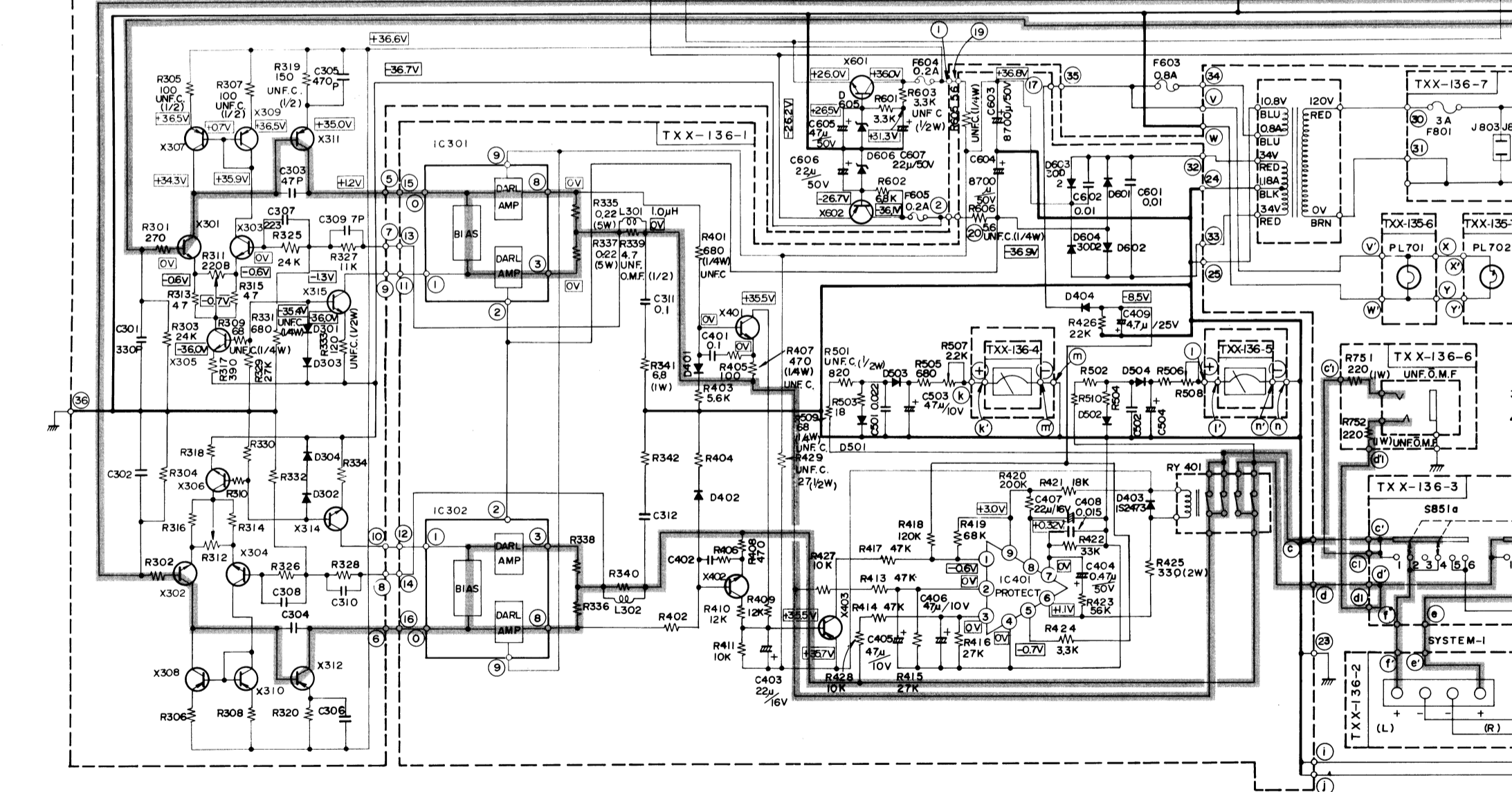
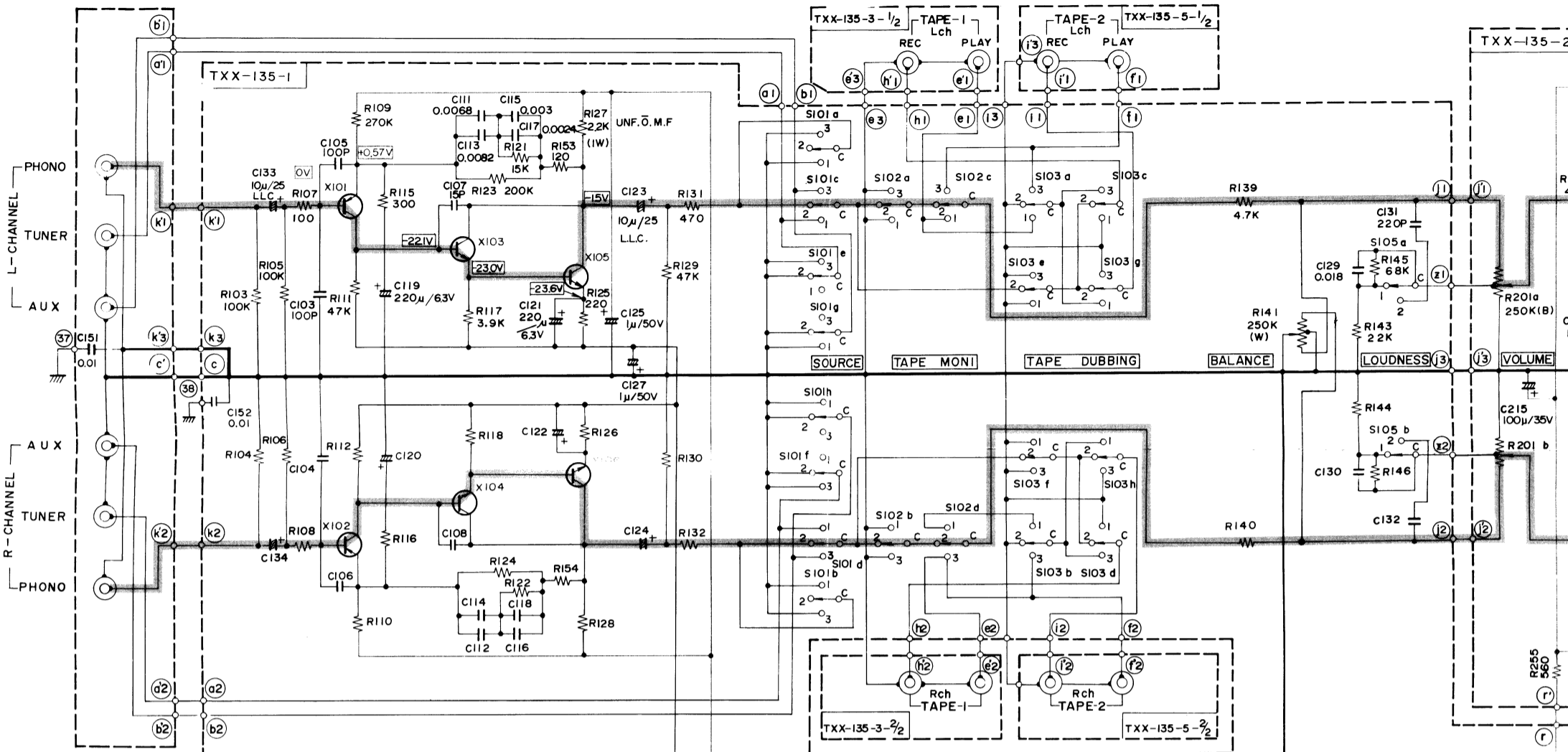

A

B







C

D

Printed Circuit Board Ass'y Locations

P.C. Board Ass'y	Description	Page
TXX-135	Equalizer, Tone Control and Driver Amp. P.C. Board Ass'y	9
TXX-136	Power Amp. & Power Supply P.C. Board Ass'y	15
TPS-194A	AC Outlets & Voltage Selector P.C. Board Ass'y	19
TPS-197A	Line Voltage Selector P.C. Board Ass'y	19

Notes:

1. Parts in red indicate transistors or ICs.
2.  indicates signal path.
3.  indicates positive B power supply. Voltage values in  are positive.
4.  indicates negative B power supply. Voltage values in  are negative.
5. When replacing the parts in the darkened areas  and those marked with , be sure to use the designated parts to ensure safety.
6. This is the standard circuit diagram.
The design and contents are subject to change without notice.

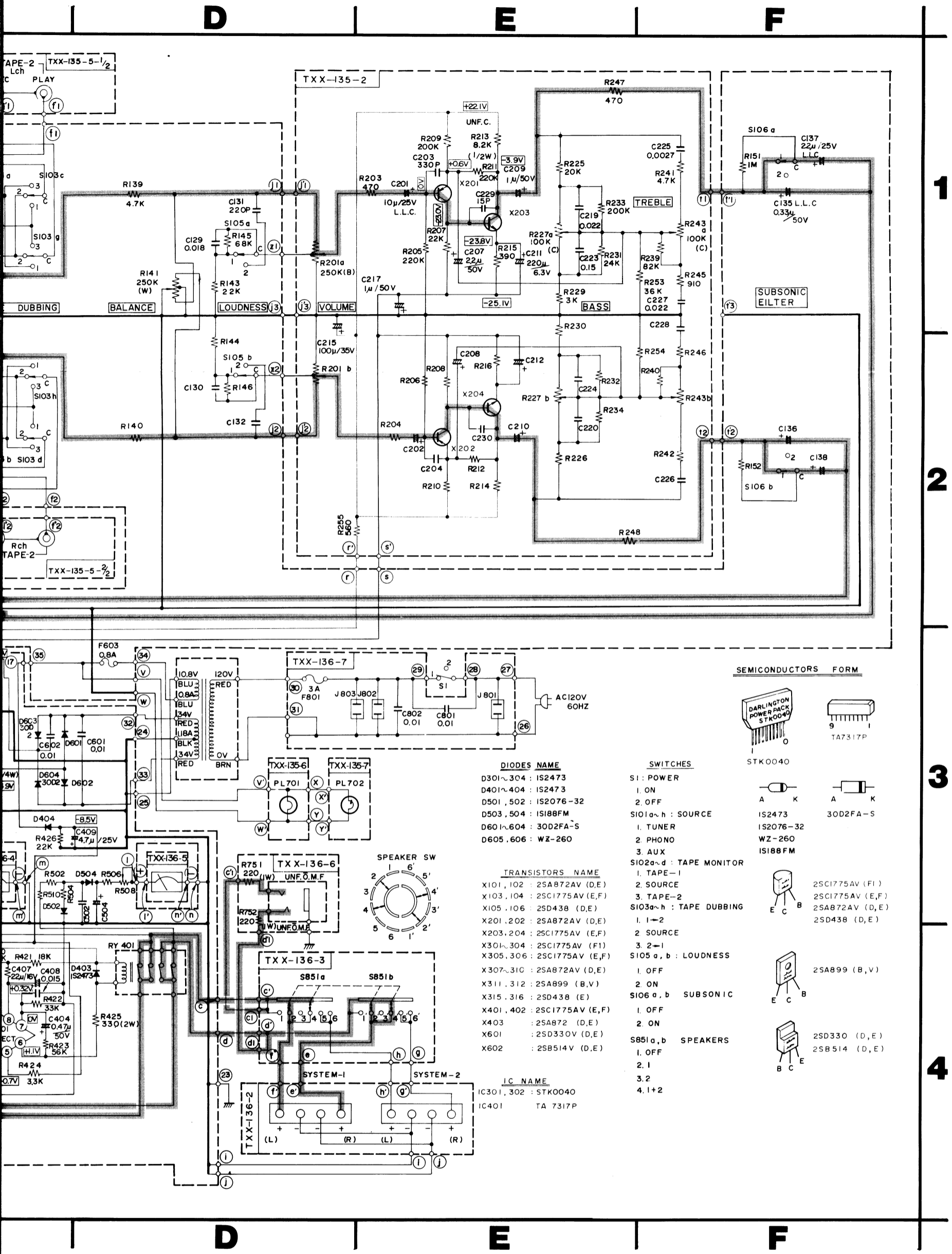

1

2

3

4

SEMICONDUCTORS FORM

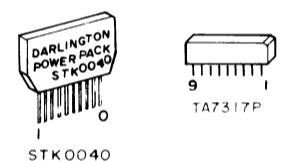

DIODES NAME

- D301~304 : IS2473
- D401~404 : IS2473
- D501, 502 : IS2076-32
- D503, 504 : IS188FM
- D601~604 : 30D2FA-S
- D605, 606 : WZ-260

SWITCHES

- S1 : POWER
- 1. ON
- 2. OFF
- S101a~h : SOURCE
- 1. TUNER
- 2. PHONO
- 3. AUX
- S102a~d : TAPE MONITOR
- 1. TAPE-1
- 2. SOURCE
- 3. TAPE-2
- S103a~h : TAPE DUBBING
- 1. 1-2
- 2. SOURCE
- 3. 2-1
- S105 a, b : LOUDNESS
- 1. OFF
- 2. ON
- S106 a, b : SUBSONIC
- 1. OFF
- 2. ON
- S851a, b : SPEAKERS
- 1. OFF
- 2. 1
- 3. 2
- 4. 1+2

TRANSISTORS NAME

- X101, 102 : 2SA872AV (D,E)
- X103, 104 : 2SC1775AV (E,F)
- X105, 106 : 2SD438 (D,E)
- X201, 202 : 2SA872AV (D,E)
- X203, 204 : 2SC1775AV (E,F)
- X301~304 : 2SC1775AV (F1)
- X305, 306 : 2SC1775AV (E,F)
- X307~310 : 2SA872AV (D,E)
- X311, 312 : 2SA899 (B,V)
- X315, 316 : 2SD438 (E)
- X401, 402 : 2SC1775AV (E,F)
- X403 : 2SA872 (D,E)
- X601 : 2SD330V (D,E)
- X602 : 2SB514V (D,E)

IC NAME

- IC301, 302 : STK0040
- IC401 : TA 7317P

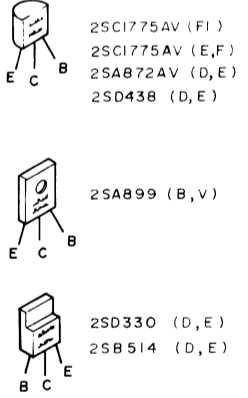

Red areas and those marked with a square symbol indicate parts to ensure safety.

Change without notice.

(E), (A), (BS) (E) for EUROPE : ~ 220V, 50Hz
 (A) for AUSTRALIA : ~ 240V, 50Hz
 (BS) for U.K. : ~ 240V, 50Hz

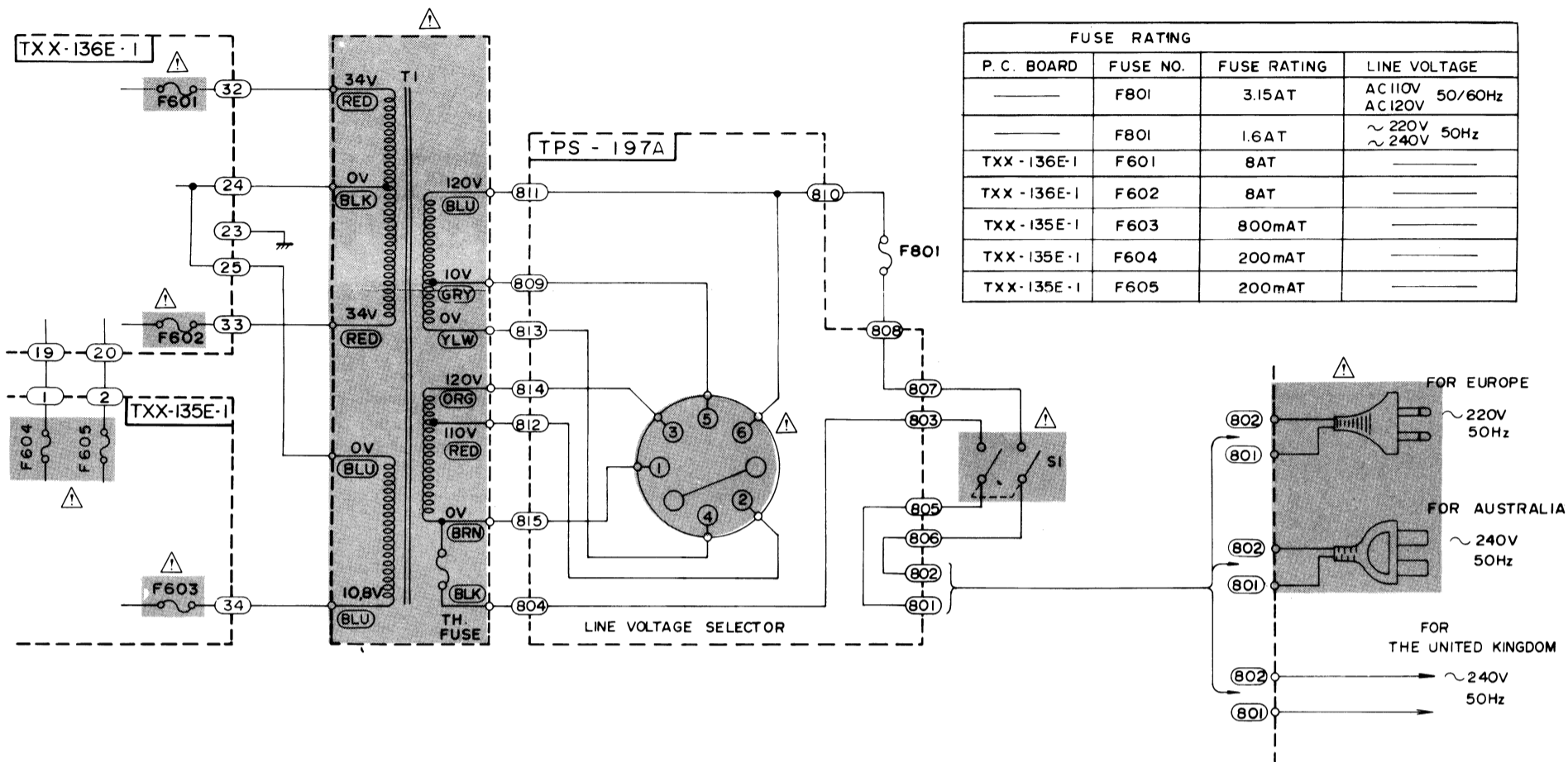

(C) for CANADA : AC120V 60Hz

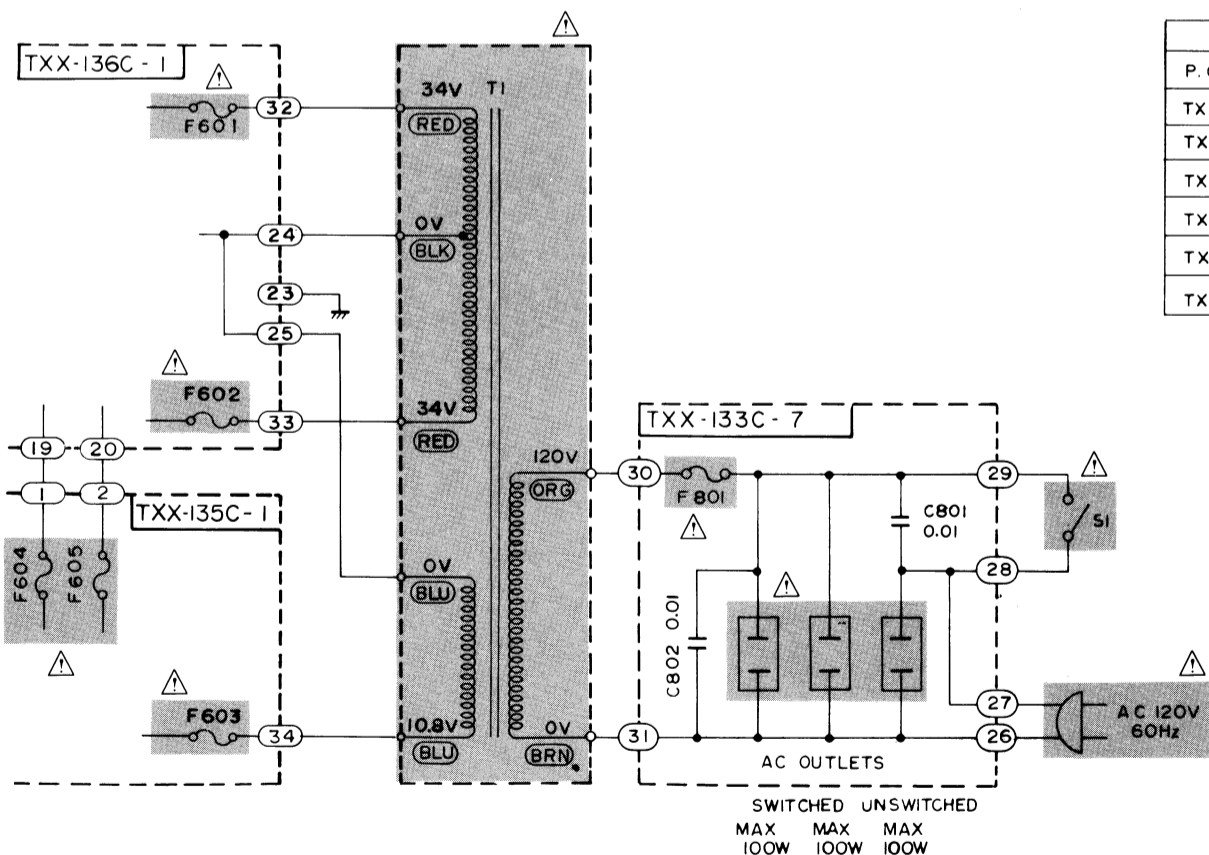

(U), (P), (

TXX-136D-1

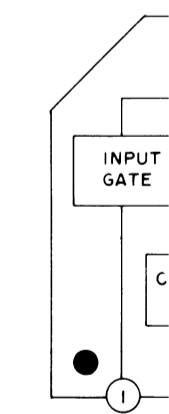
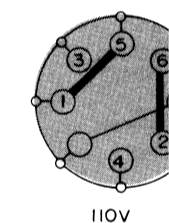
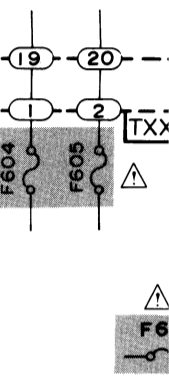

(U), (P), (F) (U) for OTHER COUNTRIES
(P), (F) for PACEX

TYPE	LINE VOLTAGE
AC110V	50/60Hz
AC120V	
~ 220V	50Hz
~ 240V	

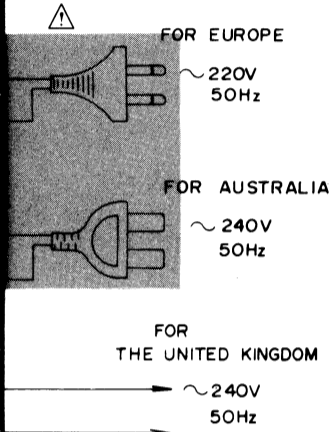

FUSE RATING			
P. C. BOARD	FUSE NO.	FUSE RATING	LINE VOLTAGE
---	F801	3.3A	AC110V 50/60Hz
---	F801	1.8A	~ 220V 50Hz
TXX-135D-1	F603	0.8A	---
TXX-135D-1	F604	0.2A	---
TXX-135D-1	F605	0.2A	---

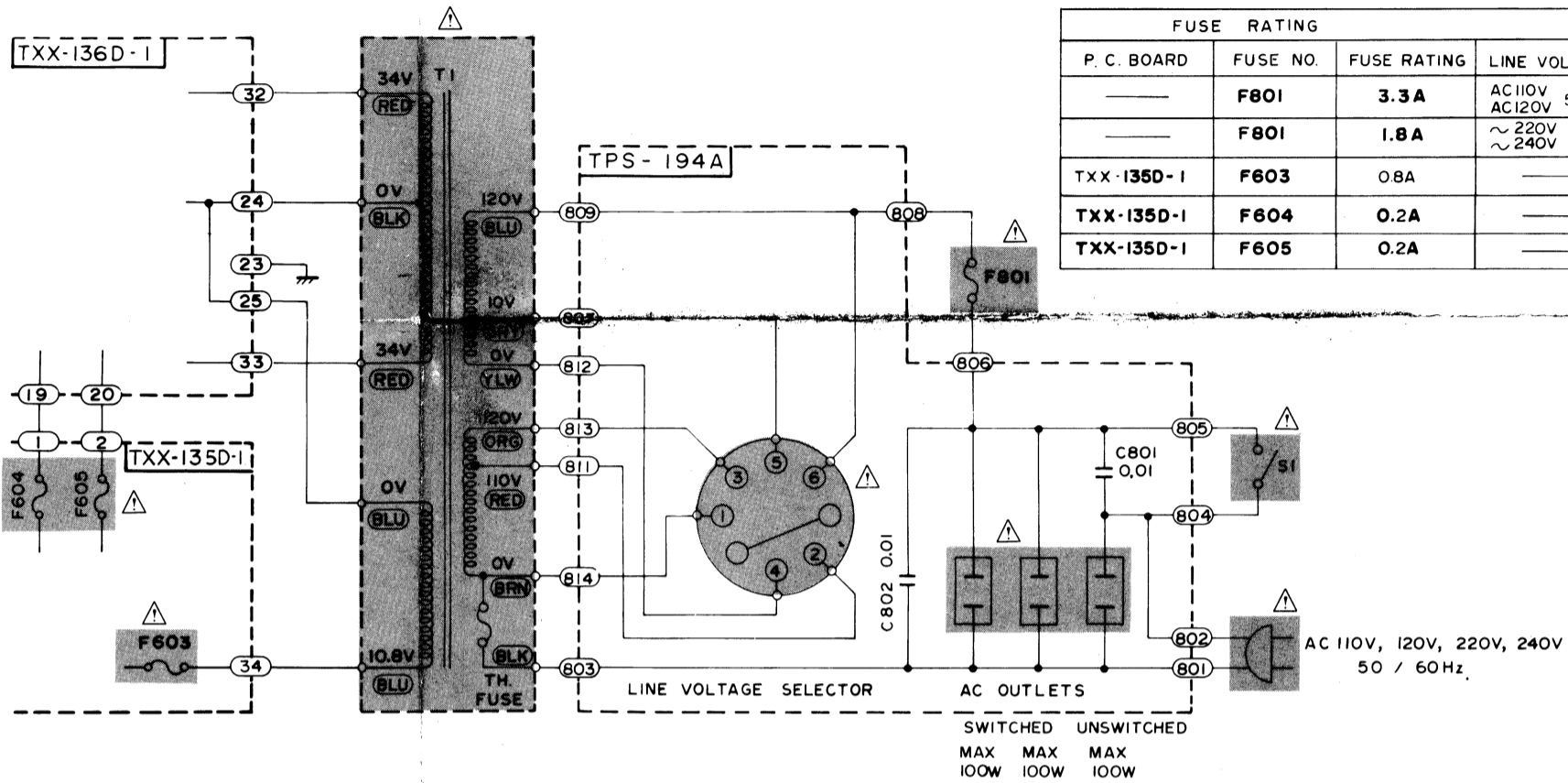

TYPE	LINE VOLTAGE
AC120V,	60Hz

VOLTAGE SELECTOR CONNECTION

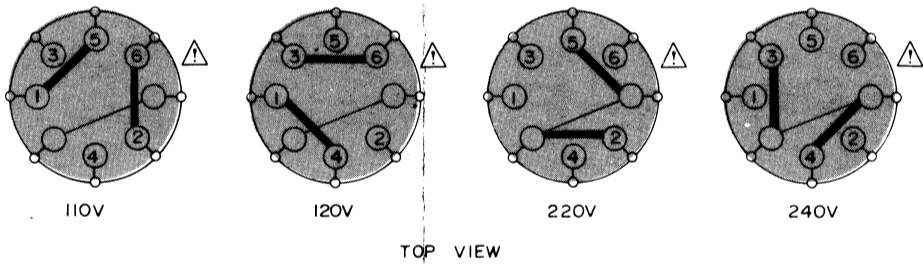

DIN CONNECTOR

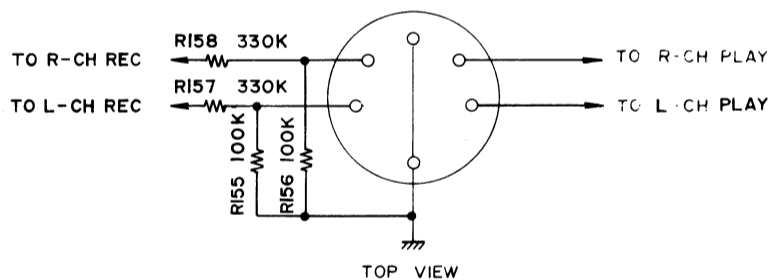

ATTACHED TO (E),(A),(BS),(U),(P),(F) TYPE MODEL

PROTECTOR IC IC 401 TA7317P

