

SR-502 (silver)

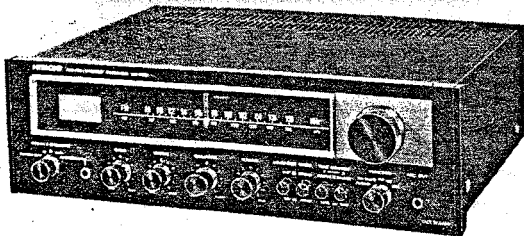

SR-502 (black)

HITACHI HI-FI COMPONENT STEREO RECEIVER

MODEL SR-302

MODEL SR-502

SERVICE MANUAL

1. SPECIFICATIONS

FM SECTION

Frequency range	88-108MHz
Sensitivity (IHF)	1.9 μ V
Harmonic distortion	
Mono	0.2% (400Hz)
Stereo	0.6% (400Hz)
Capture ratio (IHF)	1.2dB
Signal-to-noise ratio	65dB
Stereo separation	40dB (1kHz)
Selectivity (IHF)	46dB
Image rejection	52dB
IF rejection	90dB
Spurious rejection	80dB
AM suppression	56dB
Antenna impedance	300 ohms

AM SECTION

Frequency range	530-1,605kHz
Sensitivity (IHF)	300 μ V/m (S/N 20dB), 20 μ V
Signal-to-noise ratio	50dB
Image rejection	55dB
IF rejection	37dB

AUDIO SECTION

Music power (IHF)	
SR-302	25W/ch+25W/ch (8 ohms, 1kHz, 1%)
SR-502	37W/ch+37W/ch (8 ohms, 1kHz, 1%)
RMS power	
SR-302	15W/ch+15W/ch (40Hz-20kHz, 8 ohms) 16W/ch+16W/ch (8 ohms, 1kHz, 1%)
SR-502	20W/ch+20W/ch (40Hz-20kHz, 8 ohms) 25W/ch+25W/ch (8 ohms, 1kHz, 1%)
Harmonic distortion	
at 1/2 rated output	0.1% (1kHz)
Intermodulation distortion	
at 1/2 rated output	0.1% (60Hz:7kHz = 4:1)
Frequency response (IHF)	20Hz-30kHz (\pm 1dB)

Power bandwidth (IHF)	20Hz-40kHz
Damping factor	30 (8ohms, 1kHz)
Hum and noise (IHF)	
Phono	66dB
Aux	70dB
Input sensitivity	
Phono	2.5mV (50 kohms)
Aux	200mV (100 kohms)
Tape	200mV (35 kohms)
Phono overload	100mV (1kHz, 1%)
Tape out level	
Tape out	200mV
DIN (Tape out)	40mV
Tone control	
Bass	\pm 10dB (100Hz)
Treble	\pm 10dB (10kHz)
Dimensions	444(W) \times 137(H) \times 347(D)mm (120V set) 424(W) \times 136(H) \times 347(D)mm (220-240V set)
Weight	
SR-302 (120V set)	7.8kg
(220-240V set)	7.6kg
SR-502 (120V set)	8.6kg
(220-240V set)	8.4kg
Power supply	AC 120, 220-240V, 50/60Hz
Power consumption	
SR-302	75W (120V set) 115W (220-240V set)
SR-502	110W (120V set) 170W (220-240V set)

Auxiliary circuits

FM stereo indicator, Signal meter, Illuminated dial pointer, 2 tape monitor switches (SR-502 only), FM muting switch, Loudness switch, DIN tape IN-OUT, Speaker selector switch, Headphone jack.

* The above specifications are subject to change for improvement without notice.

MODEL SR-302 SR-502 SERVICE MANUAL

2. FEATURES

1. Since a high performance FET is used in the input stage of the FM tuner, noise and interference are decreased.
2. The employment of a sharp characteristic ceramic filter and a high quality IC in the IF amplifier section of the FM tuner has further improved the selectivity, capture ratio and distortion characteristics.
3. The signal strength meter indicates the correct tuning point during the reception of broadcasts.
4. Equalizer circuit and the drive-stage of the main amplifier are high S/N ratio circuits using

the low noise and high dynamic range dual power (positive negative) IC.

5. All-stage direct-connection inverted Darlington OCL circuit, which uses NPN, PNP silicone transistor with good linearity, is employed to improve frequency characteristic, power bandwidth and distortion ratio.
6. Since REC OUT jack is installed in the front panel, connection for recording can be done without going round of to the rear panel.
7. Two sets of speakers can be connected and selected by switching.

3. FRONT AND REAR PANEL

FRONT PANEL

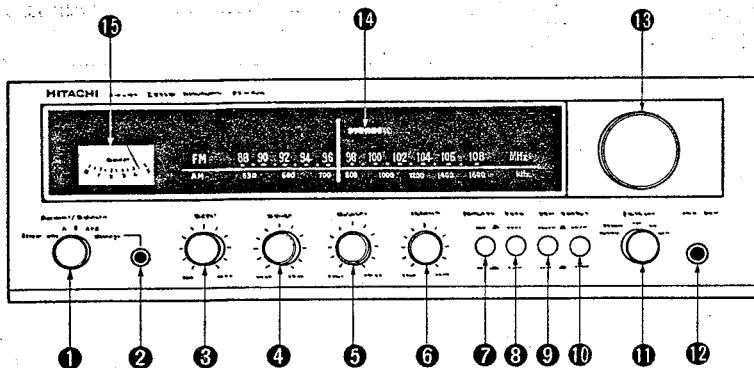

Fig. 1

REAR PANEL

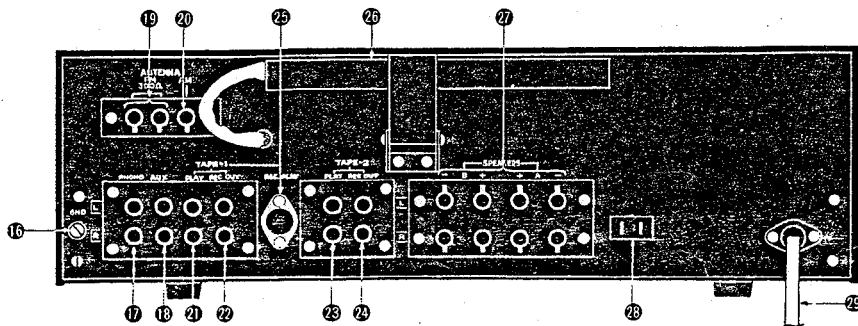

Fig. 2

- ① POWER/SPEAKER SWITCH
- ② HEADPHONE JACK
- ③ BASS CONTROL
- ④ TREBLE CONTROL
- ⑤ BALANCE CONTROL
- ⑥ VOLUME CONTROL
- ⑦ LOUDNESS SWITCH
- ⑧ MODE SWITCH
- ⑨ FM MUTE SWITCH (SR-302)
TAPE MONITOR SWITCH -1 (SR-502)
- ⑩ TAPE MONITOR SWITCH (SR-302)
TAPE MONITOR SWITCH-2 (SR-502)
- ⑪ FUNCTION SWITCH
- ⑫ REC OUT JACK
- ⑬ TUNING
- ⑭ FM STEREO INDICATOR
- ⑮ SIGNAL METER

- ⑯ GROUND TERMINAL
- ⑰ PHONO INPUT TERMINALS
- ⑱ AUXILIARY INPUT TERMINALS
- ⑲ FM ANTENNA TERMINALS
- ⑳ AM ANTENNA TERMINAL
- ㉑ TAPE-1 PLAYBACK TERMINALS
- ㉒ TAPE-1 REC OUT TERMINALS
- ㉓ TAPE-2 PLAYBACK TERMINALS (SR-502 only)
- ㉔ TAPE-2 REC OUT TERMINALS (SR-502 only)
- ㉕ DIN REC/PLAY SOCKET
- ㉖ AM BAR ANTENNA
- ㉗ SPEAKER TERMINALS
- ㉘ AC OUTLET (for 120V set only)
- ㉙ AC POWER CORD

MODEL SR-302 SR-502 SERVICE MANUAL

4. DIFFERENCE OF SR-302 AND SR-502

4.1 SPECIFICATIONS

	SR-302	SR-502
Music power (IHF)	25W/ch+25W/ch (8 ohms, 1kHz, 1%)	37W/ch+37W/ch (8 ohms, 1kHz, 1%)
RMS power	15W/ch+15W/ch (40Hz-20kHz, 8 ohms) 16W/ch+16W/ch (8 ohms, 1kHz, 1%)	20W/ch+20W/ch (40Hz-20kHz, 8 ohms) 25W/ch+25W/ch (8 ohms, 1kHz, 1%)
Power consumption	75W (for U.S.A. & Canada) 115W (for U.K., Sweden & Europe)	110W (for U.S.A. & Canada) 170W (for U.K., Sweden & Europe)
Input sensitivity		
PHONO	210mV (100 kohms)	200mV (100 kohms)
TAPE	210mV (35 kohms)	200mV (35 kohms)
Signal to noise ratio		
Phono	50dB	55dB
AUX	62dB	65dB

4.2 CIRCUIT AND REPLACEMENT PARTS

SYMBOL NO.	SR-302			SR-502		
	STOCK NO.	DESCRIPTION		STOCK NO.	DESCRIPTION	
C713(L,R)				0248647	Ceramic, discal	7pF±0.5pF 50V
C715(L,R)	0275011	Mylar, film	0.01μF±10% 50V	0274011	Mylar, film	1000pF±10% 50V
C716(L,R)	0274014	Mylar, film	0.0033μF±10% 50V			
C817	0245018	Ceramic, discal	0.022μF±20% 25V			
R701(L,R)	0114181	Carbon film	6.8kΩ±5% SRD¼P	0114177	Carbon film	4.7kΩ±5% SRD¼P
R706(L,R)	0114171	Carbon film	2.7kΩ±5% SRD¼P	0114169	Carbon film	2.2kΩ±5% SRD¼P
R725(L,R)				0119127	Metal	0.47Ω±10% RN2B
R726(L,R)				0119127	Metal	0.47Ω±10% RN2B
R727(L,R)	0119021	Metal	1Ω±10% RN1B	0119025	Metal	2.2Ω±10% RN1B
R809				0119047	Metal	33Ω±10% RN1B
R810				0119047	Metal	33Ω±10% RN1B
Q701(L,R)	2327713	2SC1162WT (C)		2327603	2SC1212WT (C)	
Q702(L,R)	2327703	2SA715WT (C)		2327393	2SA743A (C)	
Q703(L,R)	2327359	2SA670TDS (C)		2327763	2SA756 (C)	
Q704(L,R)	2327203	2SC1060 (C)		2327053	2SC1030 (C)	
	2505154	Audio printed wiring board assembly (for U.K. & Europe)		2505163	Audio printed wiring board assembly (for U.K. & Europe)	
	2505153	Audio printed wiring board assembly (for U.S.A. & Canada)		2505162	Audio printed wiring board assembly (for U.S.A. & Canada)	
				2505164	Audio printed wiring board assembly (for Sweden)	
S1	2617363	Rotary switch (for function sw.)		2617362	Rotary switch (for function sw.)	
F001	2727082	Wired in fuse (1.5A, SLOW) (for U.S.A. & Canada)		2727081	Wired in fuse (2A, SLOW) (for U.S.A. & Canada)	
F001	2720052	Wired in fuse (0.75A, SLOW) (for U.K. & Europe)		2727083	Wired in fuse (1A, SLOW) (for U.K. & Europe)	
F001				2727191	Fuse (1A, Time lag) (for Sweden)	
F701(L,R)	2727222	Fuse (2.5A, FAST)		2727223	Fuse (3A, FAST) (for U.S.A., Canada, U.K. & Europe)	
				2727335	Fuse (2.5A, Quick) (for Sweden)	
	2217872	Power transformer (for U.S.A. & Canada)		2217922	Power transformer (for U.S.A. & Canada)	
	2217873	Power transformer (for U.K. & Europe)		2217971	Power transformer (for U.K., Sweden & Europe)	
	3243611	Escutcheon assembly (for U.S.A. & Canada)		3243613	Escutcheon assembly (for U.S.A. & Canada)	
	3243612	Escutcheon assembly (for U.K. & Europe)		3243614	Escutcheon assembly (for U.K., Sweden & Europe)	

MODEL SR-302 SR-502 SERVICE MANUAL

5. SERVICE POINT

1. Removing the audio printed wiring board

Detach screws shown in Fig. 3 and Fig. 4 after removing the escutcheon. Then, detach screws on the rear of the board, pull the audio printed wiring board forward, and it can be removed together with the control plate and the radiator as shown in Fig. 5.

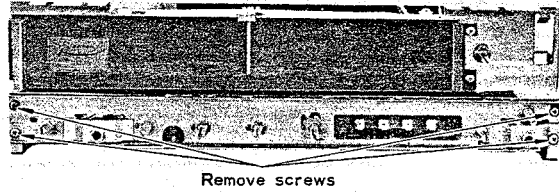

Fig. 3

2. Removing the variable resistors

After removing the escutcheon, take off then screws, nuts and washers shown in Fig. 6 to remove the control plate, then detach the variable resistors by melting the solder.

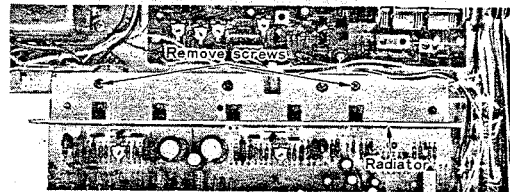

Fig. 4

3. Replacing the dial scale lamp

Remove the lamp printed wiring board on which the dial scale lamp is glued as shown in Fig. 7. To remove the lamp, unsolder the lead connections and melt the adhesive with heat of soldering iron. Do not use your fingers to remove the lamp. They may be hurt.) The replacement lamp shown in Fig. 8 is available among our service parts. There is no need to fix it with adhesive.

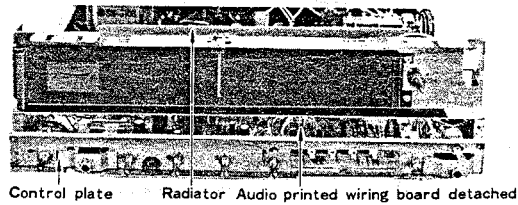

Fig. 5

4. Caution-when exchanging the power transistor

When exchanging one of the power transistors (Q701-704) due to its being deteriorated, be sure to check the other transistors. Be careful, as they may deteriorate by reaction.

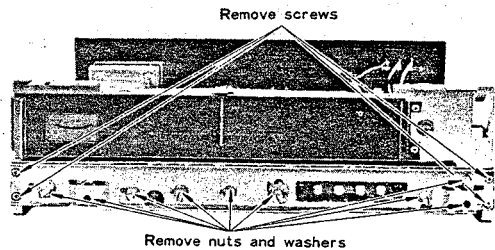

Fig. 6

5. Caution-when exchanging the FM ceramic filter

FM-IF transformer (T101) and FM ceramic filter (MF201) are identified by color, red, blue and orange, depending on the range of accuracy of their characteristics. Replace T101 and MF201 in the same color when exchanging the parts. As service parts, T101 and MF201 are replaced as a pair.

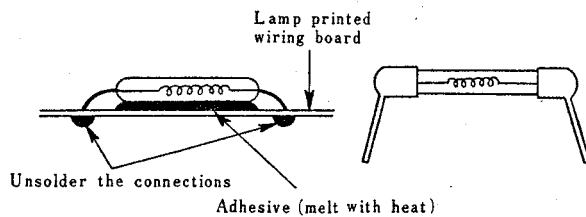

Fig. 7

Fig. 8

6. DIAL CORD SETTING

Note: The dial pulley shows the position that the variable condenser is turned to the counterclockwise direction.

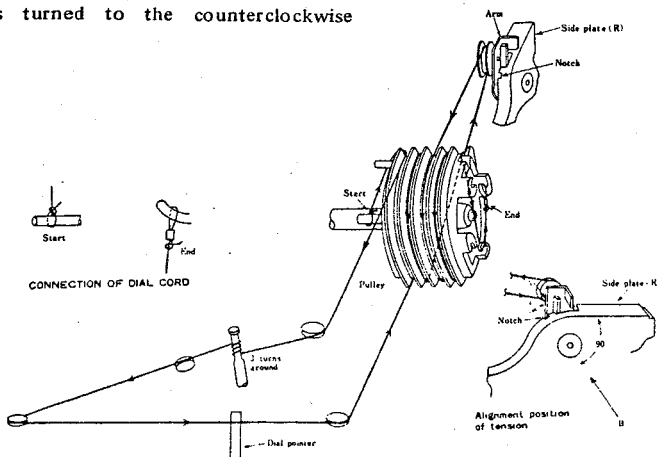

Fig. 9

7. GENERAL ALIGNMENT INSTRUCTION

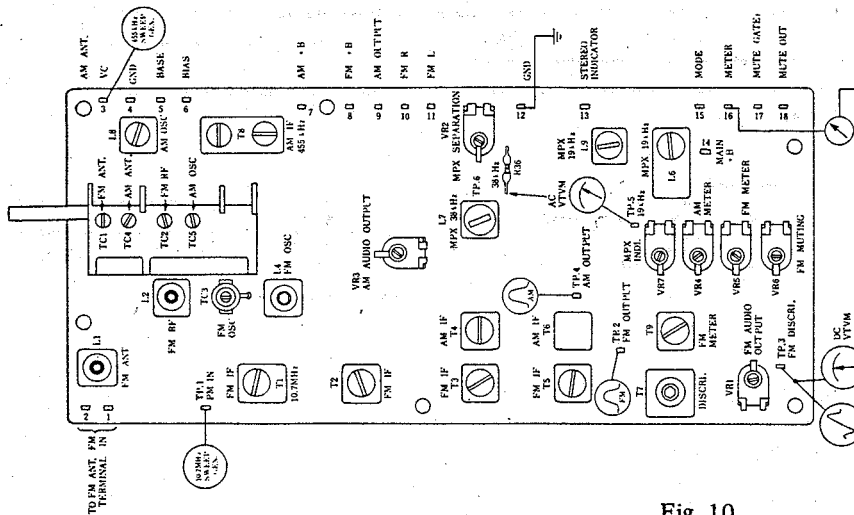

Fig. 10

7.1 FM TUNER ALIGNMENT

Steps	Item	Measuring Instrument	Input Terminal	Output Terminal	Frequency	Adjust	Wave Form
1	(1) IF Amplifier	10.7MHz±150kHz Sweep Generator	TP 1	TP 2		T107 (upper) T109	Core Max.
	(2)					T101, T102 T103, T105	CAUTION (1)
	(3) "S" curve					T107 (lower) T107 (upper)	CAUTION (2)
2	Discriminate	FM signal generator 100MHz 400Hz 100% modulated 60dB at input V.T.V.M.	Antenna terminal	TP 3 (DC balance meter)	100MHz	T107 (upper)	Adjust T107 so that pointer of Balance Meter will become 0V.
3	Distortion	FM signal generator 100MHz 400Hz 100% modulated 60dB at input Distortion meter	Antenna terminal	TAPE OUT (L) or SP OUT (L)	100MHz	T107 (lower)	Adjust T107 so that distortion will become min.
4	(1) Covering	4.1 FM signal generator 90MHz 400Hz 100% modulated 4.2 FM signal generator 106MHz 400Hz 100% modulated	Antenna terminal	TAPE OUT (L) or SP OUT (L)	90MHz (Turn the Dial pointer at 90MHz) 106MHz (Turn the Dial pointer at 106MHz)	L104	Output Max.
	(2)					TC103	
	(3)						Repeat (1) & (2)
5	(1) Tracking	5.1 FM signal generator 90MHz 400Hz 100% modulated, 10dB at input V.T.V.M. 5.2 FM signal generator 106MHz 400Hz 100% modulated, 10dB at input V.T.V.M.	Antenna terminal	TAPE OUT (L) or SP OUT (L)	90MHz	L101, L102	Output Max.
	(2)				106MHz	TC101 TC102	
6	Tuning Meter	FM signal generator 98MHz 400Hz 100% modulated, 60dB at input	Antenna terminal	Tuning Meter	98MHz (Set the Tuning meter so that pointer will be max.)	VR105	Adjust VR105 so that pointer of Tuning meter will be 4.
7	Output	FM signal generator 98MHz 400Hz 30% modulated, 60dB at input	Antenna terminal	TAPE OUT	98MHz	VR101	Adjust the output to gain 200mV±2dB.
8	FM Muting	FM signal generator 98MHz 400Hz 100% modulated, 24dB at input	Antenna terminal	TAPE OUT (L) or SP OUT (L)	98MHz	VR106	Adjust VR106 so that a signal can occur then the input signal is 24±6dB.

MODEL SR-302 SR-502 SERVICE MANUAL

CAUTION

- (1) At the article 1-(2). By the core of T101, T102, T103 and T105 let it be adjusted so that the gain will be max. And the wave form should be adjusted so that it will be the one of the Fig. 11. In this case, the output voltage at the surveying point of TP. 2 is weak, so let it be adjusted by connecting shown at Fig. 12, using V.T.V.M. Next, adjust it by T109 core, so that the wave form of Fig. 11 will dip just as Fig. 13 and at this time of adjustment stop the oscillation. (Oscillation variable capacitor is shorted.)

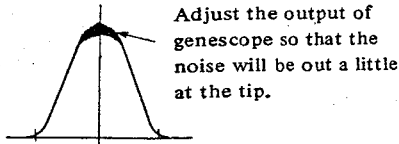

Fig. 11

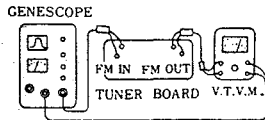

Fig. 12

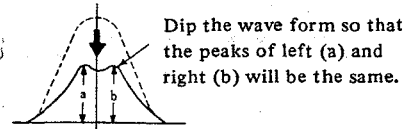

Fig. 13

- (2) At the article 1-(3). Adjust so that it will be just as S curve of Fig. 14 with the secondary core (upper) of T107. And by the primary core (lower) of the T107, adjust it so that the gain will be max. In this case, A and B will be at the symmetry position of C, and adjust it as the straight line can be gained. At the time of adjustment of Caution (1) and (2), we use ceramic filter, so the center of the marker will not sometimes come on that of wave form. In this case, neglect the marker.

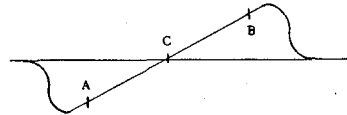

Fig. 14

2 FM MPX ALIGNMENT

Steps	Item	Measuring Instrument	Input Terminal	Output Terminal	Frequency	Adjust	Wave Form
						VR107	Set the VR107 in the center.
(1)	19kHz 38kHz Tuning coil	FM signal generator 60dB at input Stereo signal generator pilot signal (19kHz) 8% modulated V.T.V.M.	Antenna terminal	TP 5	100MHz	L106, L109	Adjust L106 and L109 so that 19kHz. output wave form becomes max.
(2)				TP 6		L107	Adjust L107 so that the (38kHz) output wave form becomes max.
(1)	Separation	1. FM signal generator 100MHz, 60dB at input 2. Stereo signal generator Main signal 92% modulated Pilot signal 8% modulated V.T.V.M.	Antenna terminal	FM OUT (L) or SP OUT (L)	100MHz		Set the tuning knob so that pointer of meter will become max.
(2)						L109	After making the signal of L ch and Pilot, adjust L109 so that the output wave form of L ch become max.
(3)						VR102	After making the signal of R ch and Pilot, adjust VR102 so that the output wave form of L ch becomes min.
(4)							Optimize VR102 so that the leak level of the L ch signal is equal to that of the R ch signal.
	Lighting Level of STEREO Indicator Lamp	FM signal generator 100MHz 60dB at input Stereo signal generator pilot signal (19kHz) 5% modulated.	Antenna terminal	STEREO Indicator Lamp	100MHz	VR107	Adjust VR107 so that stereo indicator lamp will be lighted when the modulation degree of pilot signal is 5%.

7.3 AM TUNER ALIGNMENT

Steps	Item	Measuring Instrument	Input Terminal	Output Terminal	Frequency	Adjust	Wave Form
1	IF Amplifier	Sweep generator 455kHz	Antenna terminal	TP 4		T104, T108	Gain Max. CAUTION (3)
2	Covering	AM signal generator 600kHz 400Hz 30% modulated, 50dB at input V.T.V.M.	Ferrite antenna	TAPE OUT or SP OUT	600kHz	L108	Gain Max. CAUTION (4)
		1400kHz			TC105		
3	Tracking	AM signal generator 600kHz 400Hz 30% modulated, 50dB at input V.T.V.M.	Ferrite antenna	TAPE OUT or SP OUT	600kHz	Ferrite antenna	Gain Max. CAUTION (4)
AM signal generator 1400kHz 400Hz 30% modulated, 50dB at input V.T.V.M.		1400kHz			TC104		
4	Tuning Meter	AM signal generator 1000kHz 400Hz 30% modulated, 74dB at input	Ferrite antenna	TAPE OUT or SP OUT	1000kHz	VR104	Adjust VR104 so that pointer of meter will be 3.2.
5	Output	AM signal generator 1000kHz 400Hz 30% modulated, 74dB at input V.T.V.M.	Ferrite antenna	TAPE OUT	1000kHz	VR103	Adjust VR103 so that the output becomes 200mV ± 2dB.

CAUTION

- (3) At the article 1, adjust T104 and T108, so that the wave form will be as in Fig. 15. As T108 contains ceramic filter of 455kHz sometimes the center of the marker will not come on that of the wave form. In this case, neglect the marker.
- (4) At the article 2 and 3, at the time of the first adjustment, make input power at 74dB and as the adjustment goes on, make it the minimum and necessary input power (50dB).

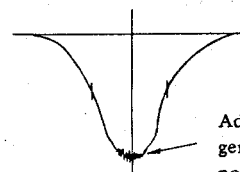

Adjust the output of genescope so that the noise will be out a little at the tip.

Fig. 15

7.4 AUDIO CIRCUIT ALIGNMENT

Item	Measuring Instrument	Point to be Measured	Adjust	Value Adjusted
Idle current (SR-502)	DC volt meter	R725 L,R	VR705 L,R	20 ± 10mV (40 ± 20mA)
Idle current (SR-302)	DC ampere meter	Connect the DC ampere meter as shown in Fig. 16.	VR705 L,R	40 ± 20mA (20 ± 10mV)

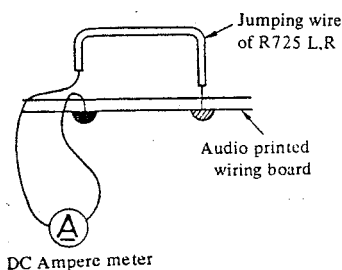

Fig. 16

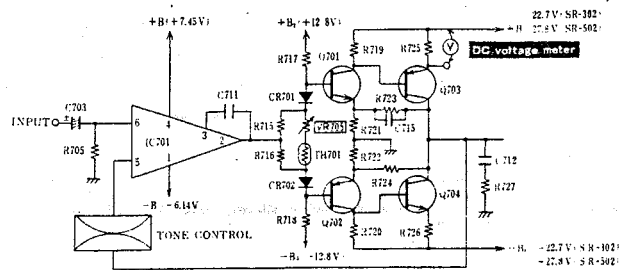
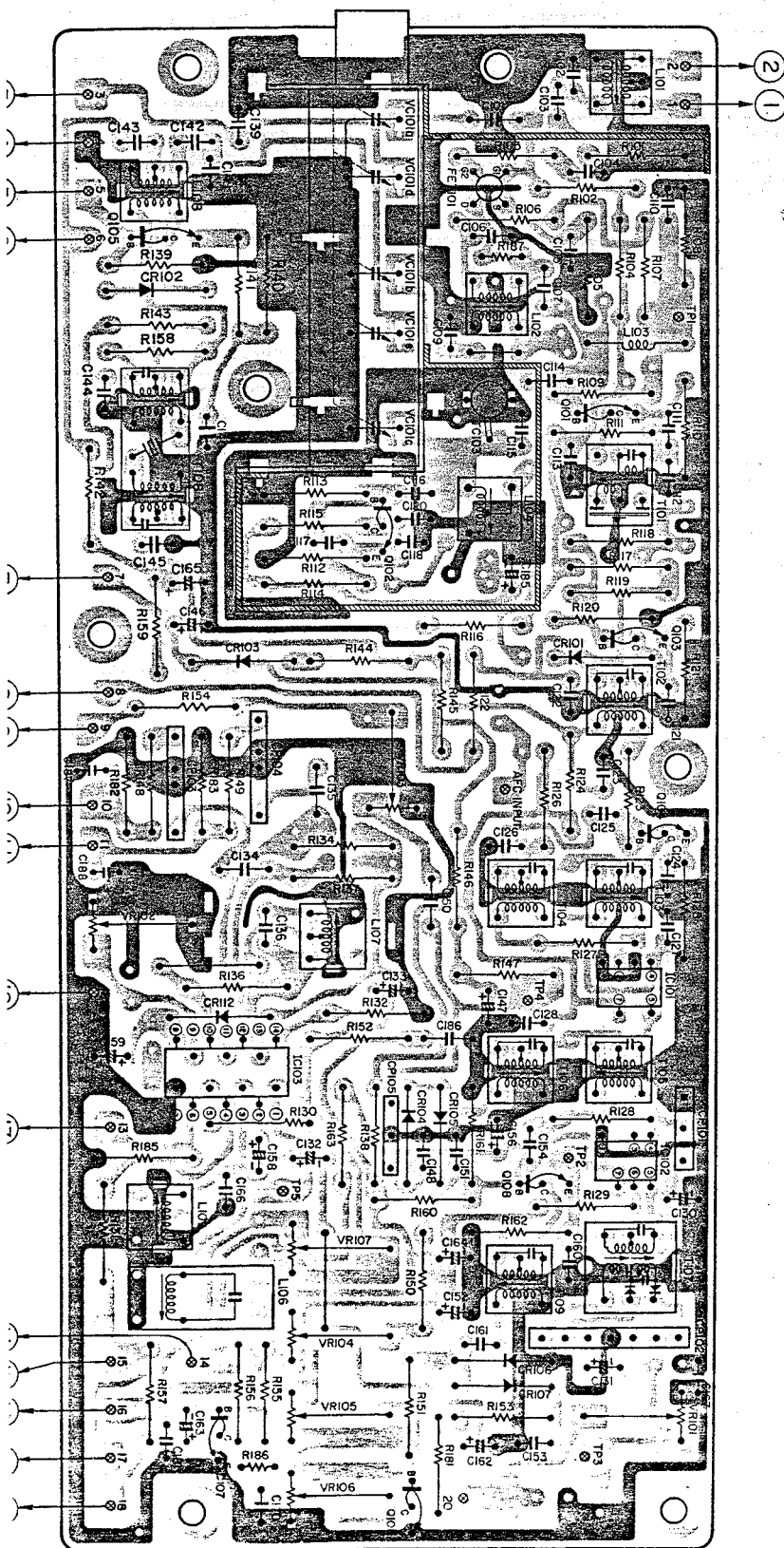

Fig. 17

MODEL SR-302 SR-502 SERVICE MANUAL

8. TUNER PRINTED WIRING BOARD



- ① FM INPUT
- ② FM INPUT
- ③ FERRITE ANTENNA
- ④ EARTH
- ⑤ FERRITE ANTENNA
- ⑥ FERRITE ANTENNA
- ⑦ AM+B (12.8V)
- ⑧ FM+B (12.8V)
- ⑨ AM OUTPUT
- ⑩ FM OUTPUT (R)
- ⑪ FM OUTPUT (L)
- ⑫ EARTH
- ⑬ STEREO INDICATOR LAMP
- ⑭ +B (12.8V)
- ⑮ MODE SWITCH
- ⑯ SIGNAL METER
- ⑰ MUTE GATE
- ⑱ MUTE OUTPUT

9. LAMP PRINTED WIRING BOARD

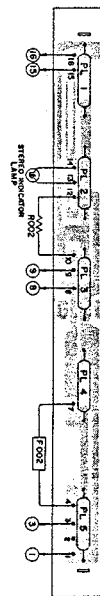

- ① POWER TRANSFORMER
- ③ POWER TRANSFORMER
- ⑧ DIAL POINTER
- ⑨ DIAL POINTER
- ⑮ TUNER PRINTED WIRING BOARD ⑬
- ⑯ AUDIO PRINTED WIRING BOARD ⑳

MODEL SR-302 SERVICE MANUAL SR-502

11. SR-302 AUDIO PRINTED WIRING BOARD

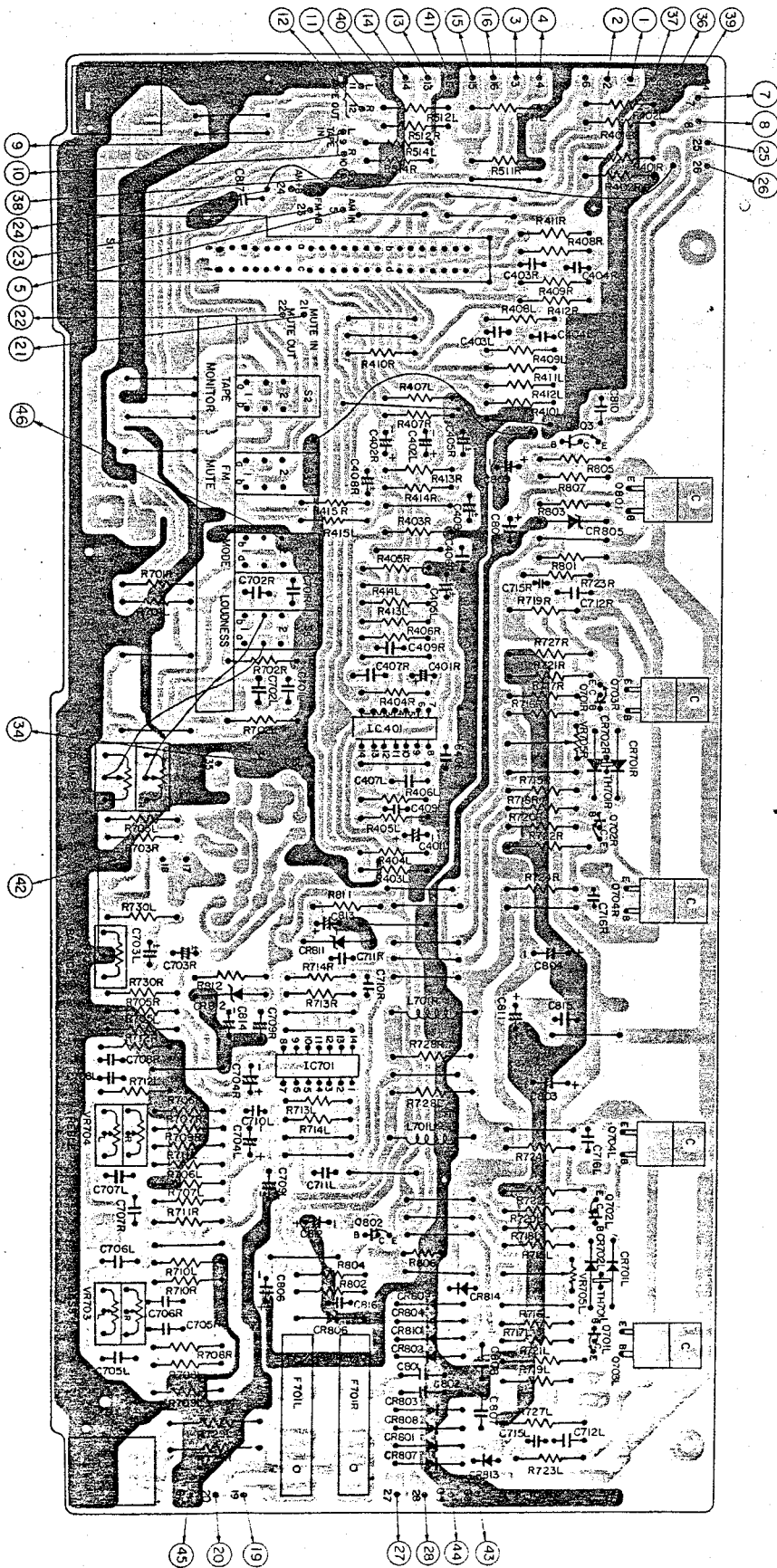

- ① PHONO INPUT (L)
- ② PHONO INPUT (R)
- ③ FM INPUT (L)
- ④ FM INPUT (R)
- ⑤ AM INPUT

- ⑦ AUX INPUT (L)
- ⑧ AUX INPUT (R)
- ⑨ TAPE INPUT (L)
- ⑩ TAPE INPUT (R)
- ⑪ TAPE OUTPUT (L)
- ⑫ TAPE OUTPUT (R)
- ⑬ DIN TERMINAL ③
- ⑭ DIN TERMINAL ⑤
- ⑮ DIN TERMINAL ①
- ⑯ DIN TERMINAL ④

- ⑰ ROTARY SWITCH (S 6 a)
- ⑱ ROTARY SWITCH (S 6 a)
- ⑲ MUTE OUTPUT
- ⑳ MUTE GATE
- ㉑ FM +B (12.8V)
- ㉒ AM +B (12.8V)
- ㉓ TUNER +B (12.8V)
- ㉔ STEREO INDICATOR LAMP
- ㉕ POWER TRANSFORMER
- ㉖ POWER TRANSFORMER

- ⑳ EARTH
- ㉗ EARTH
- ㉘ EARTH
- ㉙ EARTH
- ㉚ EARTH
- ㉛ EARTH
- ㉜ EARTH
- ㉝ EARTH
- ㉞ EARTH
- ㉟ EARTH
- ㊱ EARTH
- ㊲ EARTH
- ㊳ EARTH
- ㊴ EARTH
- ㊵ EARTH
- ㊶ EARTH
- ㊷ EARTH
- ㊸ EARTH
- ㊹ EARTH
- ㊺ EARTH
- ㊻ EARTH
- ㊼ EARTH
- ㊽ EARTH
- ㊾ EARTH
- ㊿ EARTH
- ① TUNER PRINTED WIRING BOARD ①

MODEL SR-302 SR-502 SERVICE MANUAL

12. SR-302 AUDIO CIRCUIT DIAGRAM

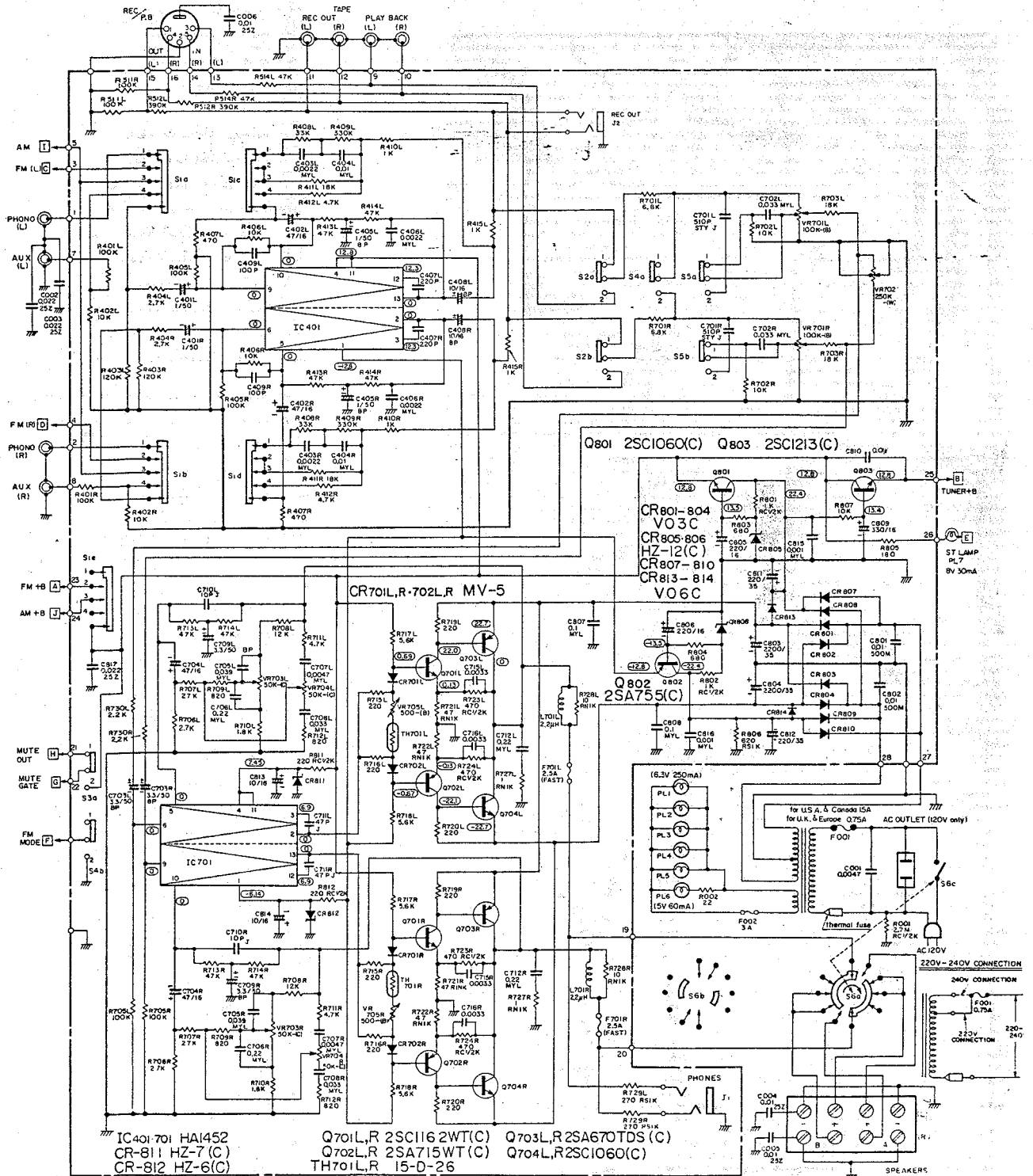

MODEL SR-302 SR-502 SERVICE MANUAL

13. SR-502 AUDIO PRINTED WIRING BOARD

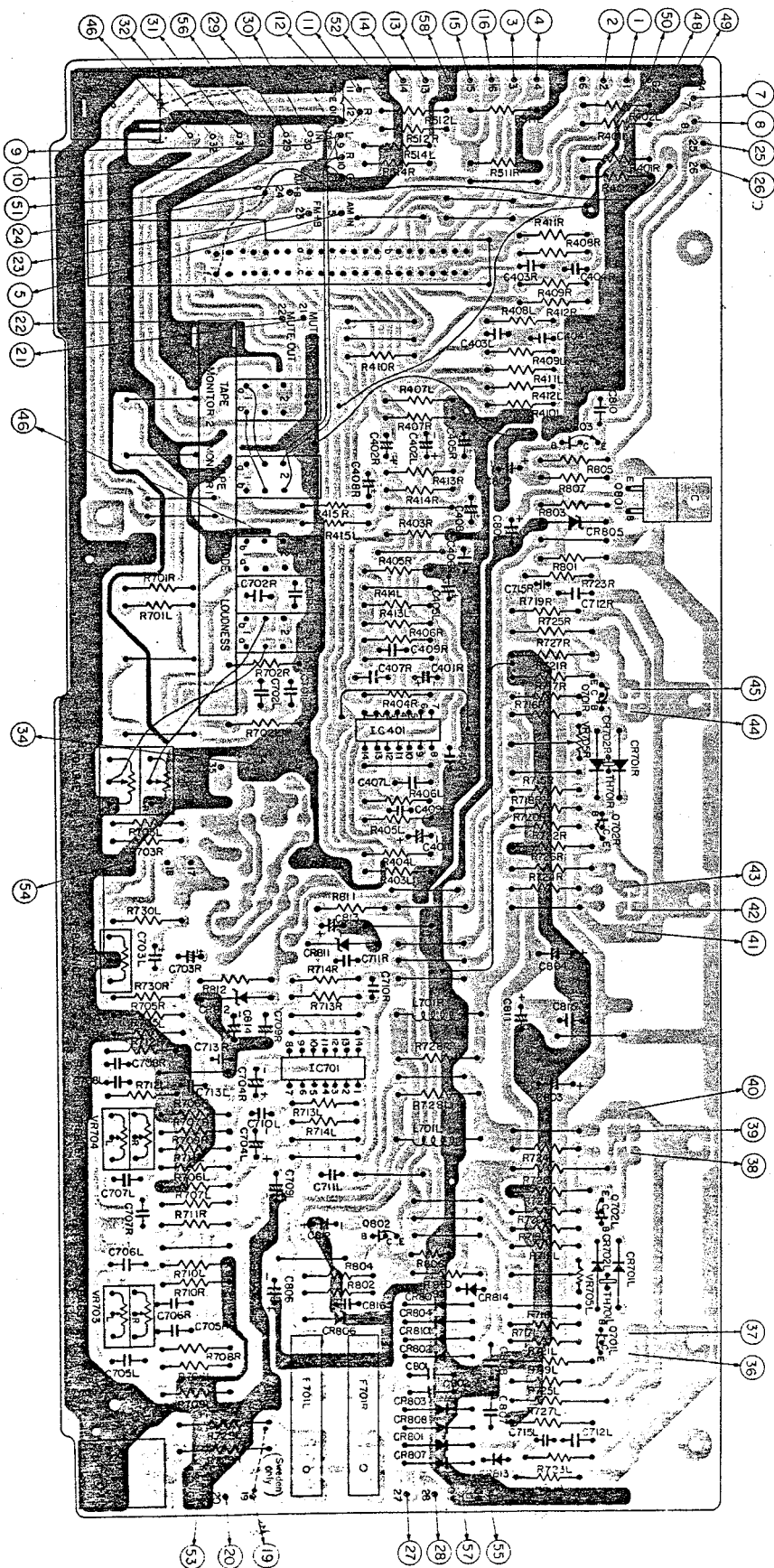

- ① PHONO INPUT (L)
- ② PHONO INPUT (R)
- ③ FM INPUT (L)
- ④ FM INPUT (R)
- ⑤ AM INPUT

- ⑦ AUX INPUT (L)
- ⑧ AUX INPUT (R)
- ⑨ TAPE-1 INPUT (L)
- ⑩ TAPE-1 INPUT (R)
- ⑪ TAPE-1 OUTPUT (L)
- ⑫ TAPE-1 OUTPUT (R)
- ⑬ DIN TERMINAL ③
- ⑭ DIN TERMINAL ⑤
- ⑮ DIN TERMINAL ①
- ⑯ DIN TERMINAL ④

- ⑲ ROTARY SWITCH (S 6 a)
- ⑳ ROTARY SWITCH (S 6 a)
- ㉑ MUTE OUTPUT
- ㉒ MUTE GATE
- ㉓ FM +B (12.8V)
- ㉔ AM +B (12.8V)
- ㉕ TUNER +B (12.8V)
- ㉖ STEREO INDICATOR LAMP
- ㉗ POWER TRANSFORMER
- ㉘ POWER TRANSFORMER
- ㉙ TAPE-2 INPUT (L)
- ㉚ TAPE-2 INPUT (R)
- ㉛ TAPE-2 OUTPUT (L)
- ㉜ TAPE-2 OUTPUT (R)

- ⑳ EARTH
- ㉞ Q703L (BASE)
- ㉟ Q703L (EMITTER)
- ㊱ Q704L (BASE)
- ㊲ Q704L (EMITTER)
- ㊳ Q704L (COLLECTOR)
- ㊴ Q704L (COLLECTOR)
- ㊵ Q704L (BASE)
- ㊶ Q704L (EMITTER)
- ㊷ Q703R (BASE)
- ㊸ Q703R (EMITTER)
- ㊹ TUNER PRINTED WIRING BOARD ⑮

- ㊺ EARTH
- ㊻ EARTH
- ㊼ EARTH
- ㊽ EARTH
- ㊾ EARTH
- ㊿ EARTH
- ⓫ EARTH
- ⓬ EARTH
- ⓭ EARTH
- ⓮ EARTH
- ⓯ EARTH
- ⓰ EARTH
- ⓱ EARTH
- ⓲ EARTH
- ⓳ EARTH
- ⓴ EARTH
- ⓵ EARTH
- ⓶ EARTH
- ⓷ EARTH
- ⓸ EARTH
- ⓹ EARTH
- ⓺ EARTH
- ⓻ EARTH
- ⓼ EARTH
- ⓽ EARTH
- ⓾ EARTH
- ⓿ EARTH

MODEL SR-302 SR-502 SERVICE MANUAL

14. SR-502 AUDIO CIRCUIT DIAGRAM

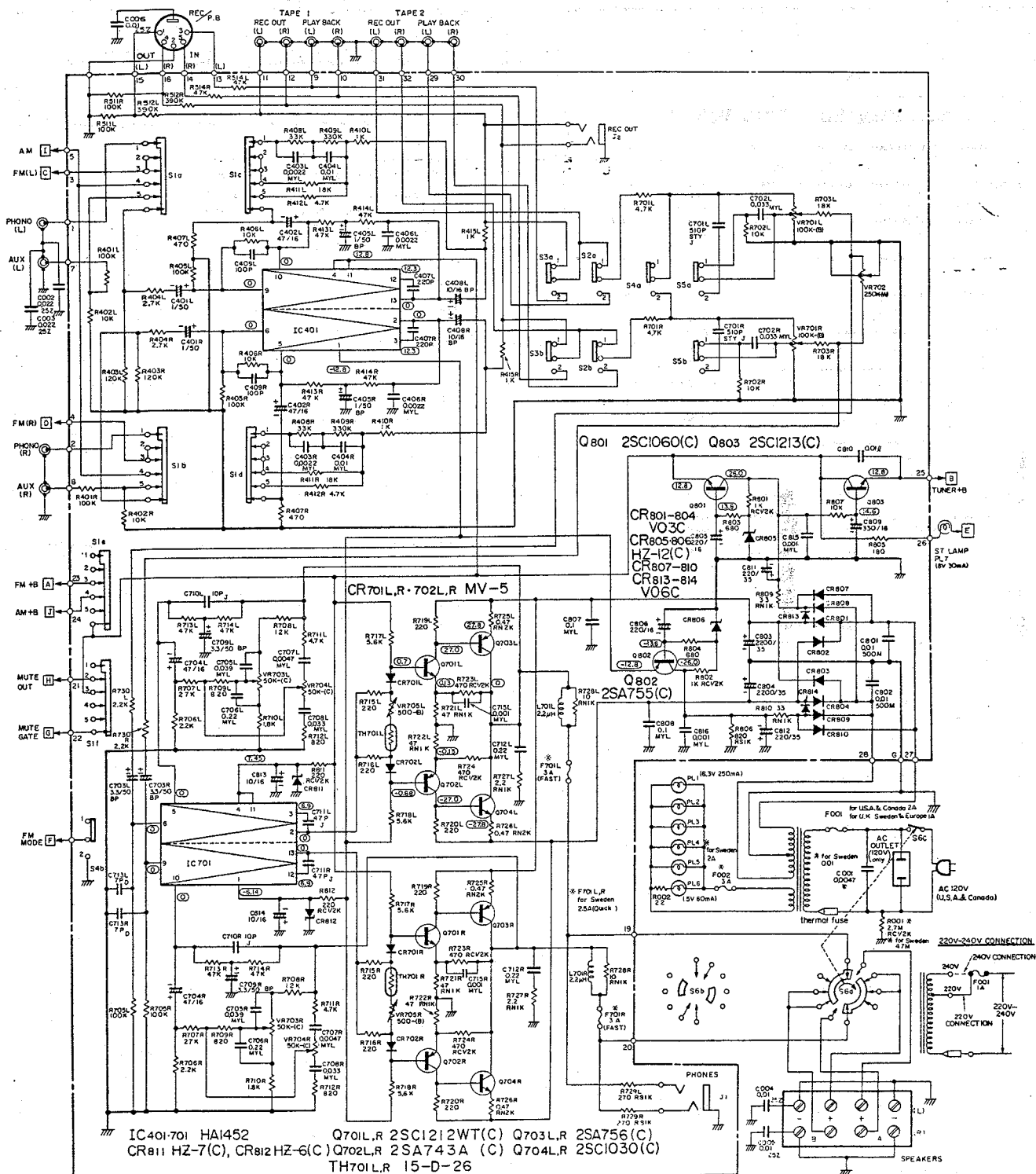

MODEL SR-302 SERVICE MANUAL

NOTE: * marked parts used for U.K. & Europe
 o marked parts used for Sweden
 © marked parts used for U.S.A. & Canada

5. REPLACEMENT PARTS LIST

SYMBOL NO.	STOCK NO.	DESCRIPTION	SYMBOL NO.	STOCK NO.	DESCRIPTION
CAPACITORS					
for TUNER PRINTED WIRING BOARD					
C101	0246464	Ceramic, discal			
C102	0246412	Ceramic, discal			
C103	0248676	Ceramic, discal			
C104	0245017	Ceramic, discal			
C105	0245017	Ceramic, discal			
C106	0245017	Ceramic, discal			
C107	0248632	Ceramic, discal			
C109	0246449	Ceramic, discal			
C110	0248362	Ceramic, discal			
C111	0245017	Ceramic, discal			
C112	0245017	Ceramic, discal			
C113	0245017	Ceramic, discal			
C114	0248631	Ceramic, discal			
C115	0248176	Ceramic, discal			
C116	0248176	Ceramic, discal			
C117	0246417	Ceramic, discal			
C118	0246444	Ceramic, discal			
C120	0245017	Ceramic, discal			
C121	0245018	Ceramic, discal			
C122	0245018	Ceramic, discal			
C123	0274011	Mylar, film			
C124	0245018	Ceramic, discal			
C125	0248632	Ceramic, discal			
C126	0245018	Ceramic, discal			
C127	0245018	Ceramic, discal			
C128	0245018	Ceramic, discal			
C130	0252815	Electrolytic			
C131	0252815	Electrolytic			
C132	0252811	Electrolytic			
C133	0252815	Electrolytic			
C134	0276011	Mylar, film			
C135	0276011	Mylar, film			
C136	0228343	Styrol			
C139	0248632	Ceramic, discal			
C140	0275011	Mylar film			
C141	0248497	Ceramic, discal			
C142	0228324	Styrol			
C143	0275011	Mylar, film			
C144	0245018	Ceramic, discal			
C145	0245018	Ceramic, discal			
C146	0252811	Electrolytic			
C147	0252813	Electrolytic			
C148	0275012	Mylar, film			
C150	0275015	Mylar, film			
C151	0275011	Mylar, film			
C152	0252525	Electrolytic			
C153	0245018	Ceramic, discal			
C154	0248668	Ceramic, discal			
C156	0252813	Electrolytic			
C158	0252813	Electrolytic			
C159	0252532	Electrolytic			
C160	0245018	Ceramic, discal			
C161	0248728	Ceramic, discal			
C162	0252811	Electrolytic			
C163	0252861	Electrolytic			
C164	0252525	Electrolytic			
C165	0252811	Electrolytic			
C166	0221513	Styrol			
C167	0245018	Ceramic, discal			
		100pF ±5%			50V
		2pF ±0.25pF			50V
		47pF ±5%			50V
		0.01μF ^{+80%} / _{-20%}			25V
		0.01μF ^{+80%} / _{-20%}			25V
		0.01μF ^{+80%} / _{-20%}			25V
		2pF ±0.25pF			50V
		24pF ±5%			50V
		220pF ±5%			50V
		0.01μF ^{+80%} / _{-20%}			25V
		0.01μF ^{+80%} / _{-20%}			25V
		0.01μF ^{+80%} / _{-20%}			25V
		1pF ±0.25pF			50V
		18pF ±5%			50V
		18pF ±5%			50V
		7pF ±0.25pF			50V
		15pF ±5%			50V
		0.01μF ^{+80%} / _{-20%}			25V
		0.022μF ^{+80%} / _{-20%}			25V
		0.022μF ^{+80%} / _{-20%}			25V
		1000pF ±10%			50V
		0.022μF ^{+80%} / _{-20%}			25V
		0.022μF ^{+80%} / _{-20%}			25V
		0.022μF ^{+80%} / _{-20%}			25V
		0.022μF ^{+80%} / _{-20%}			25V
		0.022μF ^{+80%} / _{-20%}			25V
		4.7μF			50V
		4.7μF			50V
		1μF			50V
		4.7μF			50V
		0.1μF ±10%			50V
		0.1μF ±10%			50V
		2200pF ±5%			50V
		2pF ±0.25pF			50V
		0.01μF ±10%			50V
		20pF ±5%			50V
		360pF ±5%			50V
		0.01μF ±10%			50V
		0.022μF ^{+80%} / _{-20%}			25V
		0.022μF ^{+80%} / _{-20%}			25V
		1μF			50V
		3.3μF			50V
		0.015μF ±10%			50V
		0.047μF ±10%			50V
		0.01μF ±10%			50V
		47μF			16V
		0.022μF ^{+80%} / _{-20%}			25V
		22pF ±5%			50V
		3.3μF			50V
		3.3μF			50V
		220μF			16V
		0.022μF ^{+80%} / _{-20%}			25V
		150pF ±10%			50V
		1μF			50V
		1μF			50V(KU)
		47μF			16V
		1μF			50V
		4700pF ±5%			50V
		0.022μF ^{+80%} / _{-20%}			25V
C170	0245018	Ceramic, discal			
C181	0245018	Ceramic, discal			
C185	0252811	Electrolytic			
C186	0245018	Ceramic, discal			
o C187	0274233	Mylar, film			
o C187	0274234	Mylar, film			
* C188	0274233	Mylar, film			
© C188	0274234	Mylar, film			
		0.022μF ^{+80%} / _{-20%}			25V
		0.022μF ^{+80%} / _{-20%}			25V
		1μF			50V
		0.022μF ^{+80%} / _{-20%}			25V
		2700pF ±5%			50V
		3900pF ±5%			50V
		2700pF ±5%			50V
		3900pF ±5%			50V
for AUDIO PRINTED WIRING BOARD					
C401(L,R)	0252811	Electrolytic			
C402(L,R)	0252525	Electrolytic			
C403(L,R)	0274013	Mylar, film			
C404(L,R)	0275011	Mylar, film			
C405(L,R)	0257181	Electrolytic			
C406(L,R)	0274013	Mylar, film			
C407(L,R)	0248732	Ceramic, discal			
C408(L,R)	0257145	Electrolytic			
C409(L,R)	0248724	Ceramic, discal			
C701(L,R)	0228328	Styrol			
C702(L,R)	0275014	Mylar, film			
C703(L,R)	0257183	Electrolytic			
C704(L,R)	0252525	Electrolytic			
C705(L,R)	0275034	Mylar, film			
C706(L,R)	0276013	Mylar, film			
C707(L,R)	0274015	Mylar, film			
C708(L,R)	0275014	Mylar, film			
C709(L,R)	0257183	Electrolytic			
C710(L,R)	0248650	Ceramic, discal			
C711(L,R)	0248676	Ceramic, discal			
C712(L,R)	0276013	Mylar, film			
C713(L,R)	0248647	Ceramic, discal			
C715(L,R)	0274014	Mylar, film			
C715(L,R)	0274011	Mylar, film			
C716(L,R)	0274014	Mylar, film			
		510pF ±5%			50V
		0.033μF ±10%			50V
		3.3μF			50V
		47μF			16V
		0.039μF ±10%			50V
		0.22μF ±10%			50V
		4700pF ±10%			50V
		0.033μF ±10%			50V
		3.3μF			50V
		10pF ±5%			50V
		47pF ±5%			50V
		0.22μF ±10%			50V
		7pF ±0.5pF			50V (SR-502)
		0.0033μF ±10%			50V (SR-502)
		1000pF ±10%			50V (SR-502)
		0.0033μF ±10%			50V (SR-502)
C801	0245408	Ceramic, discal			
C802	0245408	Ceramic, discal			
C803	0252742	Electrolytic			
C804	0252742	Electrolytic			
C805	0252532	Electrolytic			
C806	0252532	Electrolytic			
C807	0276011	Mylar, film			
C808	0276011	Mylar, film			
C809	0252533	Electrolytic			
C810	0275011	Mylar, film			
C811	0252732	Electrolytic			
C812	0252732	Electrolytic			
C813	0252521	Electrolytic			
C814	0252521	Electrolytic			
C815	0274011	Mylar, film			
C816	0274011	Mylar, film			
C817	0245018	Ceramic, discal			
		0.01μF ±20%			500V
		0.01μF ±20%			500V
		2200μF			35V
		2200μF			35V
		220μF			16V
		220μF			16V
		0.1μF ±10%			50V
		0.1μF ±10%			50V
		330μF			16V
		0.01μF ±10%			50V
		220μF			35V
		220μF			35V
		10μF			16V
		10μF			16V
		1000pF ±10%			50V
		1000pF ±10%			50V
		0.022μF ^{+80%} / _{-20%}			25V (SR-502)
for CHASSIS ASSEMBLY					
© C001	0243873	Ceramic, discal			
* C001	0243875	Ceramic, discal			
o C001	0261201	Ceramic, discal			
C002	0245018	Ceramic, discal			
C003	0245018	Ceramic, discal			
C004	0245017	Ceramic, discal			
		4700pF ^{+80%} / _{-20%}			500V
		4700pF ±20%			250V
		0.01μF ±20%			250V
		0.022μF ^{+80%} / _{-20%}			25V
		0.022μF ^{+80%} / _{-20%}			25V
		0.01μF ^{+80%} / _{-20%}			25V

MODEL SR-302 SERVICE MANUAL

SR-502

SYMBOL NO.	STOCK NO.	DESCRIPTION				SYMBOL NO.	STOCK NO.	DESCRIPTION
R801	0134373	Composition	1k Ω	$\pm 10\%$	RC $\frac{1}{2}$ GF	CR112	2337011	1S2076
R802	0134373	Composition	1k Ω	$\pm 10\%$	RC $\frac{1}{2}$ GF	for AUDIO PRINTED WIRING BOARD		
R803	0114151	Carbon film	680 Ω	$\pm 5\%$	SRD $\frac{1}{4}$ P	CR701(L,R)	2347041	MV - 5
R804	0114151	Carbon film	680 Ω	$\pm 5\%$	SRD $\frac{1}{4}$ P	CR702(L,R)	2347041	MV - 5
R805	0114137	Carbon film	180 Ω	$\pm 5\%$	SRD $\frac{1}{4}$ P	CR801	2327031	VO3C
R806	0119432	Metal, oxide	820 Ω	$\pm 10\%$	RD1PA	CR802	2327031	VO3C
R807	0114201	Carbon film	10k Ω	$\pm 5\%$	SRD $\frac{1}{4}$ P	CR803	2327031	VO3C
R809	0119047	Metal	33 Ω	$\pm 10\%$	RN1B (SR-502)	CR804	2327031	VO3C
R810	0119047	Metal	33 Ω	$\pm 10\%$	RN1B (SR-502)	CR805	2337103	HZ - 12 (C)
R811	0134365	Composition	220 Ω	$\pm 10\%$	RC $\frac{1}{2}$ GF	CR806	2337103	HZ - 12 (C)
R812	0134365	Composition	220 Ω	$\pm 10\%$	RC $\frac{1}{2}$ GF	CR807	2327041	VO6C
for CHASSIS ASSEMBLY								
* \odot R001	0139005	Composition	2.7M Ω	$\pm 10\%$	RC $\frac{1}{2}$ GF	CR808	2327041	VO6C
\circ R001	0115551	Carbon film	4.7M Ω	$\pm 5\%$	RD1P-S	CR809	2327041	VO6C
R002	0114049	Carbon film	22 Ω	$\pm 5\%$	SRD $\frac{1}{4}$ P	CR810	2327041	VO6C
TRANSISTORS								
for TUNER PRINTED WIRING BOARD								
FET101	2327431	3SK45						
IC101	2327312	HA1201						
IC102	2327411	HA1202						
IC103	2327422	HA1115 (W)						
Q101	0573510	2SC535 (B)						
Q102	0573507	2SC461 (B)						
Q103	0573486	2SC460 (B)						
Q104	0573486	2SC460 (B)						
Q105	0573491	2SC454 (B)						
Q106	2320063	2SC458 (C)						
Q107	2320063	2SC458 (C)						
Q108	0573486	2SC460 (B)						
for AUDIO PRINTED WIRING BOARD								
IC401	2367151	HA1452						
IC701	2367151	HA1452						
Q701(L,R)	2327713	2SC1162WT (C) (SR-302)						
Q701(L,R)	2327603	2SC1212WT (C) (SR-502)						
Q702(L,R)	2327703	2SA715WT (C) (SR-302)						
Q702(L,R)	2327393	2SA743A (C) (SR-502)						
Q703(L,R)	2327359	2SA670TDS (C) (SR-302)						
Q703(L,R)	2327763	2SA756 (C) (SR-502)						
Q704(L,R)	2327203	2SC1060 (C) (SR-302)						
Q704(L,R)	2327053	2SC1030 (C) (SR-502)						
Q801	2327203	2SC1060 (C)						
Q802	2327723	2SA755 (C)						
Q803	2327333	2SC1213 (C)						
DIODES								
for TUNER PRINTED WIRING BOARD								
CR101	2337011	1S2076						
CR102	2337011	1S2076						
CR103	2337011	1S2076						
CR104	0575002	1N34A						
CR105	0575002	1N34A						
CR106	0575019	1N60P						
CR107	0575019	1N60P						
VARIABLE RESISTORS								
for TUNER PRINTED WIRING BOARD								
VR101	0151281	20k Ω - (B)						
VR102	0151282	1k Ω - (B)						
VR103	0151224	10k Ω - (B)						
VR104	0151224	10k Ω - (B)						
VR105	0151224	10k Ω - (B)						
VR106	0151225	50k Ω - (B)						
VR107	0151282	1k Ω - (B)						
for AUDIO PRINTED WIRING BOARD								
VR701(L,R)	0151705	100k Ω - (B)	VOLUME					
VR702	0151716	250k Ω - (W)	BALANCE					
VR703(L,R)	0151713	50k Ω - (C)	BASS					
VR704(L,R)	0151713	50k Ω - (C)	TREBLE					
VR705(L,R)	0151241	500 Ω - (B)	Idle current adj.					
COILS & TRANSFORMERS								
for TUNER PRINTED WIRING BOARD								
L101	2134411	FM antenna coil						
L102	2134419	FM RF coil						
L103	2227081	Choke coil (1 μ H)						
L104	2134416	FM OSC coil						
L106	2134392	19kHz coil						
L107	2134373	38kHz coil						
L108	2134431	AM OSC coil						
L109	2134371	19kHz coil						
T101	2154172	FM IF transformer						
T102	0322203	FM IF transformer						
T103	2154199	FM IF transformer						
T104	2154161	AM IF transformer						
T105	0322203	FM IF transformer						
T106	2154122	AM IF transformer						
T107	2154201	FM discriminator transformer						
T108	2154183	AM IF transformer						
T109	2154292	FM IF transformer						
for AUDIO PRINTED WIRING BOARD								
L701(L,R)	2227141	Audio trap coil (2.2 μ H)						

MODEL SR-302 SERVICE MANUAL SR-502

SYMBOL NO.	STOCK NO.	DESCRIPTION	SYMBOL NO.	STOCK NO.	DESCRIPTION
for CHASSIS ASSEMBLY				2217872	Power transformer (for U.S.A. & Canada) (for SR-302)
L001	2227035	Choke coil (27 μ H)		2217873	Power transformer (for U.K. & Europe) (for SR-302)
MISCELLANEOUS				2217922	Power transformer (for U.S.A. & Canada) (for SR-502)
	2505131	Tuner printed wiring board assembly (for U.S.A. & Canada)		2217971	Power transformer (for U.K., Sweden & Europe) (for SR-502)
	2505132	Tuner printed wiring board assembly (for U.K., Sweden & Europe)		2687451	Terminal - 6P terminal
	2505153	Audio printed wiring board assembly (for U.S.A. & Canada) (for SR-302)		2687661	Terminal - 8P screw terminal
	2505154	Audio printed wiring board assembly (for U.K. & Europe) (for SR-302)		2687652	Terminal - 3P screw terminal
	2505162	Audio printed wiring board assembly (for U.S.A. & Canada) (for SR-502)		2687642	8P US pin jack
	2505163	Audio printed wiring board assembly (for U.K. & Europe) (for SR-502)		0541358	Socket - DIN socket
	2505164	Audio printed wiring board assembly (for Sweden) (for SR-502)		2657281	Socket - AC socket (UL) (for U.S.A. & Canada)
	2505102	Lamp printed wiring board assembly		2657181	Socket - transistor socket (for SR-502)
TH701(L,R)	0576042	Thermister		2748441	AC power cord (for U.S.A. & Canada)
TC103	0283121	Trimmer capacitor		2747481	AC power cord (for Europe)
VC101	0281179	FM AM variable capacitor		2747732	AC power cord (for U.K.)
CP101	0186022	CR multiple component		2747861	AC power cord (for Sweden)
CP102	0186041	CR multiple component		2787221	Belt (for AC power cord) (for Europe)
CP103	0186051	CR multiple component		4387283	AC bush plate
CP104	0186051	CR multiple component		3920381	Cover - AC socket cover (for U.K., Sweden & Europe)
CP105	0186031	CR multiple component		2757128	Ferrite antenna
	2767231	Lamp - indicator lamp (8V, 30mA)		2727181	Holder - fuse holder (for Sweden) (for SR-502)
S1	2617363	Switch - rotary switch (for function sw.) (for SR-302)		0043793	Bushing (for AC power cord) (for U.S.A., Canada & Sweden)
S1	2617362	Switch - rotary switch (for function sw.) (for SR-502)		3913001	Bushing (for AC power cord) (for Europe)
S2,3,4,5	2637601	Switch - push switch (for tape monitor sw. others)		3913005	Bushing (for AC power cord) (for U.K.)
S6	2617311	Switch - rotary switch (for power/speaker sw.) (for U.K., Sweden & Europe)		4681872	Cover - lamp cover
S6	2617312	Switch - rotary switch (for power/speaker sw.) (for U.S.A. & Canada)	for DIAL MECHANISM ASSEMBLY		
J1	2677231	Jack - headphone jack		3920111	Pulley - 30 ϕ pulley
J2	2677233	Jack - REC OUT jack		3199261	Dial scale (for U.S.A. & Canada)
F001	2727082	Fuse - wired in fuse (1.5A, SLOW) (for U.S.A. & Canada) (for SR-302)		3199262	Dial scale (for U.K., Sweden & Europe)
F001	2720052	Fuse - wired in fuse (0.75A, SLOW) (for U.K. & Europe) (for SR-302)		3386645	Dial pointer
F001	2727191	Fuse - fuse (1A, time lag) (for Sweden) (for SR-502)		4386641	Tuning shaft assembly
F001	2727081	Fuse - wired in fuse (2A, SLOW) (for U.S.A. & Canada) (for SR-502)		4567411	Screw - 3x6 ϕ CT bind screw
F001	2727083	Fuse - wired in fuse (1A, SLOW) (for U.K. & Europe) (for SR-502)	for FINAL ASSEMBLY		
F002	2727193	Fuse - fuse (2A, time lag) (for Sweden)		3243611	Escutcheon assembly (for U.S.A. & Canada) (for SR-302)
F002	2727085	Fuse - wired in fuse (3A, SLOW) (for U.S.A., Canada, U.K. & Europe)		3243612	Escutcheon assembly (for U.K. & Europe) (for SR-302)
F701(L,R)	2727222	Fuse - fuse (2.5A, FAST) (for SR-302)		3243613	Escutcheon assembly (for U.S.A. & Canada) (for SR-502)
F701(L,R)	2727223	Fuse - fuse (3A, FAST) (for SR-502) (for U.S.A., Canada, U.K. & Europe)		3243614	Escutcheon assembly (for U.K., Sweden & Europe) (for SR-502)
F701(L,R)	2727335	Fuse - fuse (2.5A, Quick) (for SR-502) (for Sweden)		3282693	Knob - Tuning knob (for U.S.A. & Canada)
	2577181	Meter		3282694	Knob - Tuning knob (for U.K., Sweden & Europe)
	4513311	Screw - earth screw		3282703	Knob - Power/speaker knob, others (for U.S.A. & Canada)
	4567411	Screw - 3x6 ϕ CT bind screw (yellow)		3282704	Knob - Power/speaker knob, others (for U.K., Sweden & Europe)
	4567451	Screw - 3x6 ϕ CT bind screw (silver)		3916411	Leg
	4567431	Screw - 3x6 ϕ CT bind screw (black)		4384593	Cover (for U.K., Sweden & Europe)
	4567412	Screw - 3x8 ϕ CT bind screw		4386481	Cover (for U.S.A. & Canada)
	4567422	Screw - 4x8 ϕ CT bind screw		3710471	Cap - headphone cap (for U.K., Sweden & Europe)
	4790096	Washer - 8 ϕ washer		4567414	Screw - 3 ϕ x12 CT bind screw
	3920141	Washer - 3 ϕ washer		4567412	Screw - 3x8 ϕ CT bind screw
	8821234	Nut - 3 ϕ nut (for Sweden)		4567449	Screw - 4 ϕ x30 CT bind screw (for U.S.A. & Canada)
				4567441	Screw - 4x6 ϕ CT bind screw (for U.K., Sweden & Europe)
				4374051	Washer - 4 ϕ washer (for U.K., Sweden & Europe)
			for CABINET ASSEMBLY		
				9410003	Side board (left) (for U.S.A. & Canada)
				9410004	Side board (right) (for U.S.A. & Canada)