

DENON

Hi Fi Component

SERVICE MANUAL

FULLY AUTOMATIC
DIRECT DRIVE TURNTABLE SYSTEM

MODEL DP-51F/52F SERIES

U.S. and Canadian models do not include cartridge.

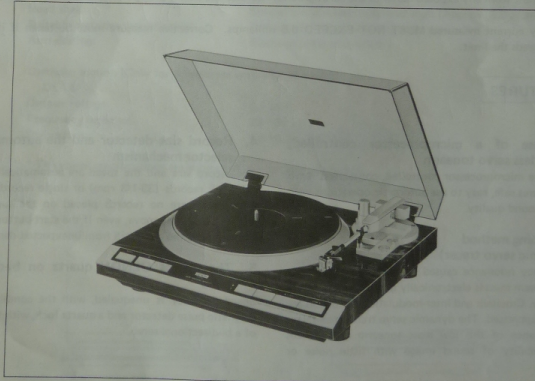

NIPPON COLUMBIA CO., LTD.

TABLE OF CONTENTS

FEATURES 1
MAIN SPECIFICATIONS 2
BLOCK DIAGRAM 3
NAMES AND PARTS AND FUNCTIONS 4
EXPLANATION OF THE MICROPROCESSOR 5~8
ADJUSTMENT METHOD 9~10
PARTS LIST OF P.C. BOARD 11~12
PARTS LIST OF EXPLODED VIEW 13
EXPLODED VIEW OF MAIN PARTS 14
P.C. BOARD UNIT 15~18
CONNECTION OF P.C. BOARD 19~20
SCHEMATIC DIAGRAM 21~25

WARNING:

1. Component parts

Parts marked with Δ and/or shading in this service manual have special characteristics important to safety. Be sure to use the specified parts for replacement.

2. Leakage current

Before returning the appliance to customer, test the leakage current when the power plug is connected. Use a calibrated (with an error of not more than 5%) leakage current tester and measure the leakage current from any exposed metal to the earth ground. Reverse the power plug polarity and test the above again.

Any current measured MUST NOT EXCEED 0.5 miliamps. Corrective measure must be taken if it exceeds the limit.

FEATURES

1. The use of a microprocessor controlled, contactless servo tonearm

An innovative microprocessor controlled, contactless servo tonearm ensures safe, easy to use automatic operations with little loss in sound quality.

2. Q-damping method (Dynamic servo tracer)

Low frequency resonance caused by cartridge compliance and the tonearm mass is electronically damped horizontally and vertically. Crosstalk and inter-modulation distortion are effectively suppressed. The dynamic servo tracer maximizes the performance of the low mass tonearm and realizes excellent stability of sound image with little noise or distortion.

3. Low mass straight arm

This arm is fully capable of maximizing the performance of high compliance cartridges with outstanding tracing ability. Even with the newest, high grade records, its tracing ability is outstanding.

4. Record size detector and the automatic speed selector mechanism

The record size and the speed are automatically set when using LP records (33-1/3 rpm) or single records (45 rpm). When there are no records placed on the turntable, the tonearm does not move, even if the start button is pressed. This protects the stylus tip from unexpected damages.

5. The use of DENON quartz on bi-directional servo

Speed accuracy is unequalled, with the combination of a magnetic pulse detector and a quartz lock, with the addition of a bi-directional servo.

MAIN SPECIFICATIONS

Drive system:	Servo controlled direct drive
Turntable speeds:	33-1/3 rpm, 45 rpm
Wow flutter:	Below 0.01% wrms (servo system) Below 0.02% wrms (JIS) Over 78dB (DIN-B)
S/N ratio:	Normal speed within 1.8 seconds (at 33-1/3 rpm)
Rise time:	Aluminum die-cast; 300 mm diameter
Turntable:	AC servo motor
Motor:	Speed servo by frequency and phase servo control
Speed control system:	0% (80 g stylus force, outer most groove)
Load influence:	Electronic brake
Brake system:	Below 0.002%
Speed deviation:	50/60 Hz, Voltage is shown on the rating label at the back of cabinet.
Power supply:	17W
Power consumption:	130 x 455 x 424 (H x W x D)
Dimensions:	Approx. 9 kg
Weight:	Dynamically balance, straight tube tonearm
Arm type:	244 mm
Effective length:	14 mm
Overhang:	Within 2.5°
Tracking error:	Electronically controlled fully automatic
Automatic mechanism:	Electronic; horizontal vertical directions
Q-damping method:	0~3 g (1 scale=0.1 g)
Adjustable stylus force range:	Specially hardened resin head shell (Approx. 3.3 g)
Head shell:	Approx. 3~12 g (including nuts, screws)
Suitable cartridge weight range:	Electronically controlled
Anti-skating:	

Cartridge section (Only for those units with a set cartridge)

DL-60	
Output voltage:	2.5 mV
Frequency response:	20~30 kHz
Stylus force:	1.8±0.3 g; MM type

* The above specifications are subject to change without notice.

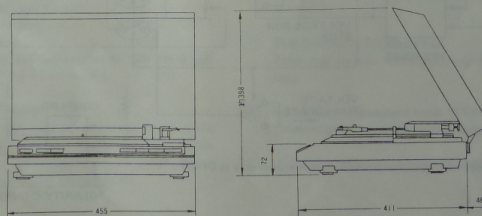

OUTER DIMENSIONS (mm)

BLOCK DIAGRAM

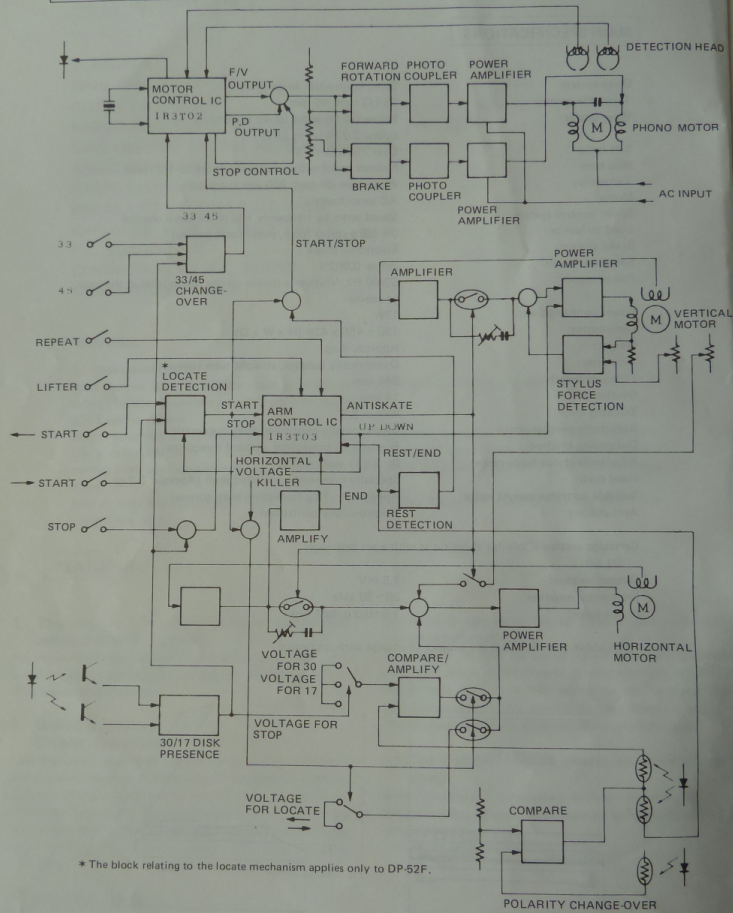

* The block relating to the locate mechanism applies only to DP-52F.

NAMES AND PARTS AND FUNCTIONS

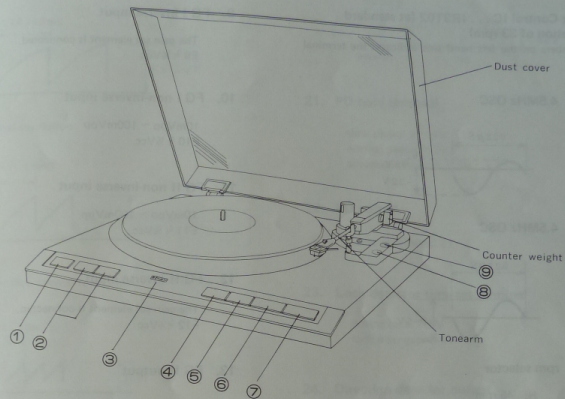

- | | |
|---|---|
| <p>① Power switch "POWER"
This turns the power supply on and off. Push the button down until it locks in position. The power will turn on and the lock indicator ('DENON') will light up. When turning the power off, press the button until the lock is disengaged. In addition, always return the tonearm to the arm rest and hold it in place with the clamp.</p> <p>② Speed selector switch "SPEED"
Set to the desired record speed.
33-1/3 rpm records "33"
45 rpm records "45"
In automatic play, the switch is set to "33" for 30 cm records and "45" for 17 cm records.</p> <p>③ Lock indicator "DENON"
The "DENON" will light up when the power is on. During play, the lamp will flicker until the proper turntable speed is reached. Once the proper speed is obtained, the lamp will, again, stay lit.</p> | <p>④ Arm lifter button "LIFTER"
This button is used to raise and lower the arm during play, or when playing the records manually.</p> <p>⑤ Repeat button "REPEAT"
Press this button when playing records repeatedly: the "REPEAT" lamp will be lit.</p> <p>⑥ Start button "START"
Press this button when starting the records automatically.</p> <p>⑦ Stop button "STOP"
Press this button when stopping the record during play.</p> <p>⑧ Stylus force adjustment knob "STYLUS FORCE"
This is used to adjust the stylus force.</p> <p>⑨ Q-damping adjustment knob "Q-DAMPING"</p> |
|---|---|

EXPLANATION OF THE MICROPROCESSOR

• Motor Control IC . . . IR3T02 (at standard revolution of 33 rpm)
The numbers on the left hand side indicates the terminal number.

2. 4.5MHz OSC

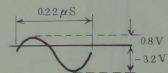

3. 4.5MHz OSC

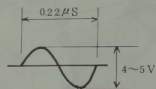

4. rpm selector

H: 45 rpm
L: 33 rpm

5. power source input

$V_{cc}: 5V \pm 0.5V$

6. FG I bypass terminal

$E6 \approx \frac{1}{2} V_{cc}$

7. FG I lowpass terminal

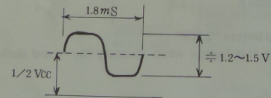

8. FG I output

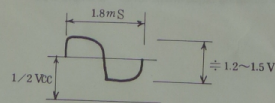

9. FG I inverse input

The gain set element is connected.
 $E9 \approx \frac{1}{2} V_{cc}$

10. FG I non-inverse input

$10mV_{pp} \sim 100mV_{pp}$
 $E10 \approx \frac{1}{2} V_{cc}$

11. FG II non-inverse input

$10mV_{pp} \sim 100mV_{pp}$
 $E11 \approx \frac{1}{2} V_{cc}$

12. FG II inverse input

The gain set element is connected.
 $E12 \approx \frac{1}{2} V_{cc}$

13. FG II output

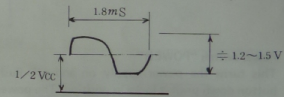

14. ground terminal

15. F/V output

slower than normal revolution: $2 \sim 4.5V$
normal revolution: $\approx 2V$
faster than normal revolution: $0 \sim 2V$

16. F/V hold terminal

same as terminal 15

17. F/V triangular wave

slower than normal revolution

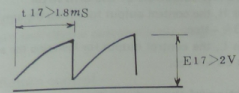

normal revolution

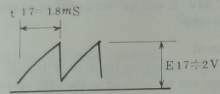

faster than normal revolution

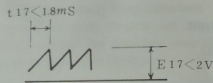

18. timing pulse width-set terminal

E18 = 0.6V

19. PD triangular wave

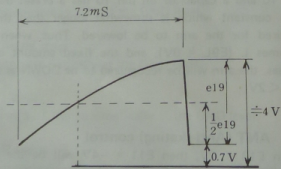

20. sample pulse monitor terminal

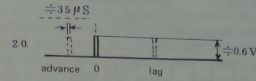

21. PD hold terminal

slow phase: 2 ~ 4V
normal phase: = 2V
advanced phase: 1 ~ 3V

22. PD output

same as terminal 21

23. Lock detector time set terminal

during lock: 0.6V
lock disengaged: 0V

24. Direction detector output

normal revolution: 0V
reverse revolution: = 4V

25. Revolution detector

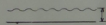
during revolution:  = 4V

stop: 0V

26. START/STOP terminal

H → START
L → STOP

27. Stop output

during stop control: 0V
during start: open

28. Lock indicator

during lock (LED lit dimly)

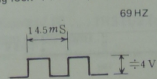

stop (LED lit)

during transition . . (LED flashes)

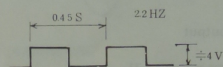

• Arm Control IC IR3T03

The numbers on the left side indicates the terminal number of the IR3T03.

3. UP/DOWN selection of the arm lifter

When E9 is H, the control output for lifting the arm will be made at E3 \approx $-V_{cc}$.
When E9 is L, the control output for lowering the arm will be made at E3 \approx $+V_{cc}$.

4. Detection of the rest position

E4 $\leq -2.64V$ will be recognized as the arm being at rest.

5. Detection of the END position

When E5 $\geq 2.64V$, it will be recognized to be within the END detection range.

6. End control

Within the END detection range of 5 (above), (E5 $\geq 2.64V$), the arm will be returned by the END control when E6 $\geq 0.23V$.

7. Matching input

E7 $\leq |\pm 0.6V|$ will be recognized as the match range for lead-in.

8. Drive output

Connect to GND.

9. UP control output

When the lifter is in the UP position during automatic arm operations or when the UP signal is sent by pressing the arm lifter button, pin 9 will be at H level.

E9H $\approx 4V$

E9L $\approx 0V$

10. DOWN time constant

To ensure that the arm is lowered completely before proceeding to the next movement, a resistor between pins 9 and 10 and a capacitor on pin 10 has a preset discharge time constant which is somewhat longer than the time required for the arm to be lowered. Thus, when pin 9 becomes L (E9L $\approx 0V$), and the fixed amount of time elapses, the arm will be recognized to be DOWN as soon as E10 $< 2V$.

11. ANT (Anti-skating) control

When E10 $< 2V$, then E11 $\approx -4V$ will be the control output needed for the anti-skating to be engaged.

When E10 $\geq 2V$, then E11 $\approx +4V$ will be the control output needed for the anti-skating to be disengaged.

12. Negative power source

Supplies $-5V$.

14. SUB (substratum)

To prevent any interference from the inner elements of the LSI, the substratum terminal is connected to the unregulated side of the negative power source, since it has the lowest electric potential.

15. GND

Standard zero electric potential is the GND.

17. Return control

When the stop command is given, or when the repeat is disengaged and the END is detected ($E6 \geq 0.23V$), a control signal output ($E17H > 4V$) is made to return the arm to rest.

$E17H > 4V$
 $E17L$: release

18. Horizontal drive control

When the arm is in resting position, or when the arm reaches the lead-in position during automatic play, and comes into the matching range ($E7 \leq |\pm 0.6V|$), a control signal output ($E18H \approx 4V$) is made to stop the horizontal motion of the arm.

20. LCTD (Located) time constant

The LSI and its outer circuits will set the LCTD time constant to improve the detection accuracy of the lead-in position and the arm rest position.

$E20H \approx 1.2V$ A few moments after the arm reaches the range of detection, in other words, after the set LCTD time constant elapses, it will become H level, where it is memorized immediately and then reset to the L level.

$E20L \approx 0V$ Before and after detection, it will become L level.

23. Start

Will start automatically at the GND level.

24. Auto stop

Will stop automatically at the GND level.

25. Lifter

Will raise the lifter automatically at the GND level.

26. Repeat

Will engage the repeat automatically at the GND level.

27. UP SW

When the arm lifter is raised, this terminal will be opened and made H level, otherwise, the UP detector will control it to make it GND level.

With this model, photo reflectors to detect the presence of reflected light from a light emitting diode and a sensor is placed opposite to the reflector cam. When the lifter is in the UP position, the reflector cam blocks the ray of light, and the raised lifter position is detected, as there is no reflection.

28. Positive power supply

Supplies +5V.

ADJUSTMENT METHOD

• Adjusting the phonomotor section

Prepare a two-channel oscilloscope for the measuring instrument; make the adjustments in the following order, by first connecting the 3P connector to test point TP1 of the motor control circuit board.

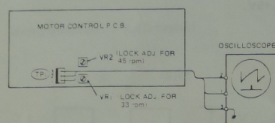

1. Adjusting the head gap

Make sure the detection head is in right angle to the magnetic coating surface of the turntable. The gap of the detection head should be adjusted to 0.18 mm. Be careful the head is not tilted to the left or the right.

2. Lock adjustments for 45 rpm

- 1) Place a record on the turntable; fix the arm to the armrest.
- 2) After pressing the start button, set the speed selector switch to 45 rpm.
- 3) Adjust VR2 so that the positions of the triangular wave form and the pulse from TP1 are as shown in the diagram below.

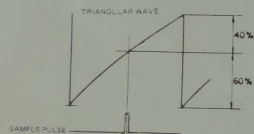

3. Lock adjustments for 33 rpm

- 1) Set the speed selector switch to 33 rpm and proceed to adjust VR1, just as in the adjustments for 45 rpm.

• Adjusting the arm control section

* Prepare a digital volt meter or an electronic volt meter for the measuring instrument; measure, using the arm point in the figure as the reference point.

* Prepare a stylus force gauge for adjusting the stylus force.

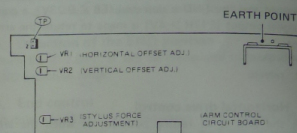

1. Adjusting the horizontal OP amp. offset voltage

- 1) Fix the tonearm to its rest and connect the volt meter to TP1.
- 2) Turn VR1 and adjust to $0V \pm 0.005V$ (5mV).

2. Adjusting the vertical (lifter) OP amp. offset voltage

- 1) Fix the tonearm to its rest and connect the volt meter to TP2.
- 2) Turn VR2 and adjust to $0V \pm 0.005V$ (5mV).

3. Adjusting the stylus force

- 1) Turn the power supply off and zero-balance the arm. (Adjust so that the arm tube and the turntable surface are parallel.)
- 2) Turn the power supply on and make sure the arm moves to its down position.
- 3) Set the stylus force scale to 2 g.
- 4) Turn VR3 so that the scale on the stylus force gauge reads 2 g.

NOTE

Make sure the arm tube and the turntable surface are parallel during zero balancing and stylus force adjustments.

4. Adjusting the 30 cm lead-in position

- 1) Place a 30 cm record on the turntable.
- 2) The arm will move when the start switch is pressed continuously. By turning the lead-in adjustment cam at the arm base with a small flat-headed screwdriver, adjust so that the stylus tip position stops at the 30 cm lead-in position.

For the DP-52F, the stylus tip will not stop at the lead-in position if the start switch is pressed continuously, as the search function will operate. When adjusting, do not press the start switch continuously; rather adjust by repeating the start procedures.

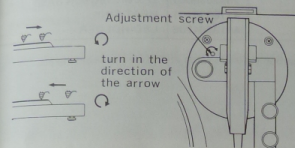

NOTE

The flat-headed screwdriver for making the adjustments should have a 4.5 mm width tip with a large grip, and the shaft diameter should be less than 5 mm diam. Place the tip surely into the grooves when turning.

In addition, since mal-operations or errors may occur with any light from outside sources, it is desirable to be cautious that no light enters the shutter section.

5. Adjusting the 17 cm lead-in position

Adjust as necessary, such as when parts of the sensor section have been replaced.

However, the following procedures should only be used when a discrepancy is found for the 17 cm lead-in position, after the 30 cm lead-in position has been adjusted.

- 1) Place a 17 cm record on the turntable.
- 2) When the start switch is pressed, the arm will move and stop. At this time, check how many millimeters (mm) to the inside or outside, the arm deviates from the prescribed 17 cm lead-in position.
- 3) Take off the bottom cover of the cabinet and check the adjustment scale position of the shutter. (One adjustment scale corresponds to a stylus tip movement of 5 mm.)

- 4) Untighten the screw holding the sub shutter and place a small screwdriver into the slot of the shutter. When the stylus position is toward the inside, compared to the required position, move the sub shutter toward the right of the scale; when the stylus position is toward the outside, move the sub shutter toward the left. When completed, tentatively tighten the screw holding the sub shutter.
- 5) After the adjustments are made, press the start switch and check whether or not the stylus stops at the 17 cm lead-in position.
- 6) If the stylus stops at the required position, then tighten the sub shutter screw.

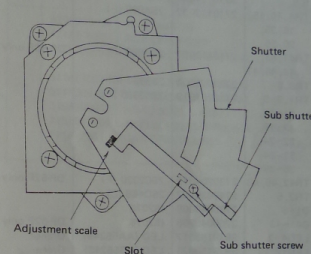

KU-403/KU-410 ARM CONTROL UNIT

Ref. No.	Part No.	Part Name	Remarks
SEMICONDUCTOR GROUP			
IC9-11	2620064000	HD74LS00P	
IC41, 43, 44	2620064000	HD74LS00P	DP-52F only
IC13	2620129013	HD74LS04P	
IC42	2620129013	HD74LS04P	DP-52F only
IC12	2620291006	HD74LS08P	
IC14	2620131001	HD74LS10P	
IC6	2620276005	HD14066BP	
IC7	2620057004	HD7473P	
IC15	2630147001	μPC78M05H	
IC16	2630160004	μPC7905H	
IC1-5	2630189001	M5218L	
IC3	2630174003	IR3T03	
TR4, 10, 15, 16, 25, 26, 35	2710113007	2SA999 (F)	
TR41, 43, 44, 46, 47	2710113007	2SA999 (F)	DP-52F only
TR3, 6	2720025004	2SB562 (C)	
TR1, 7-9, 11-14, 17-19, 22-24, 31-34, 36-39	2730204019	2SC2320 (F)	
TR42, 45, 48	2730204019	2SC2320 (F)	DP-52F only
TR2, 5	2740036002	2SD468 (C)	
D1-6	2760049008	IS2076	DP-52F only
D41-43	2760049008	IS2076	
LED4-7	3939158017	LED (AA5524S)	Orange
LED12, 13	3939158020	LED (BG5524S)	Green
LED8-11, 14-16	3939159003	LED (BG5638S)	Green
	3939158004	LED (EBR5504S)	Red
	3939075005	LED (PY5504S-1)	Yellow
	3939041001	LED (LNG1RP)	17/30
PT1, 2	3939157005	TPS605	
CDS1, 3	3939053002	CDS	
CDS2	3939053028	CDS	
RESISTOR GROUP			
VR1, 2	2116000073	V08P8203	Variable resistor
VR3	2116000086	V08P8204	20KΩ 200KΩ
CAPACITOR GROUP			
C19, 35-40	2531004007	CK45B1H102K	Ceramic 0.001μF 50V
C41, 42	2531004007	CK45B1H102K	0.001μF 50V DP-52F only
C5, 26-29	2531027000	CK45F1H104Z	0.1μF 50V
C45	2531027000	CK45F1H104Z	0.1μF 50V DP-52F only
C22, 32	2544129005	CE04W1A470=	Electrolytic 47μF 10V
C10, 11, 14, 25	2544130007	CE04W1A101=	100μF 10V
C34	2544010004	CE04W1A101=	100μF 10V
C3, 9, 12, 13, 16, 23, 30, 33	2544132005	CE04W1C100=	10μF 16V
C20	2544015009	CE04W1C100=	10μF 16V

Ref. No.	Part No.	Part Name	Remarks
C1, 6	2543015000	CE04D1E2R2MBP	2.2μFBP 25V
C8	2543016009	CE04D1H010MBP	1μFBP 50V
C14, 15, 31	2544146004	CE04W1H010=	1μF 50V Film
C2	2551074004	C093M1H153K	0.015μF 50V
C7	2551080001	C093M1H473K	0.047μF 50V
C4	2551088016	C093M1H224K	0.22μF 50V
	2228437107	ARM CONTROL	
OTHER PARTS GROUP			
S1, 3-6	2129059008	PUSH SWITCH	
S2	2129183000	DOUBLE ACTION SW	
	2032075001	2P CONNECTOR BASE	
	4178028101	HEAT SINK	
	4418764205	LED HOLDER	

• The carbon resistors rated at 1/4W are not listed herein.

PS-164 POWER SUPPLY UNIT

Ref. No.	Part No.	Part Name	Remarks
R1	2410163001	RD1482H121J	120Ω 1/2W
C2	2518001023	CP05C==AC473M	0.047μF 450V
C1	2518001007	CP05C==AC103M	0.01μF 450V
	2061015029	FUSE	1A 250V
	FEP1287	FUSE HOLDER	
	2228499006	POWER SUPPLY P.C.B	
	EE-1656	BASE TERMINAL	
	EP-5667H2	TERMINAL	

KU.442/445 MOTOR CONTROL UNIT

Ref. No.	Part No.	Part Name	Remarks
SEMICONDUCTOR GROUP			
IC1	2630173004	IR3T02	
IC3	2630188002	μPC78L05	
IC2	2630189001	M5218L	
TR1, 2	2710113007	2SA999 (F)	
TR4, 6	2710100010	2SA979 (R)	
TR5, 7	2730196017	2SC2023	
D1-6	2760049008	IS2076	
D11-18	2760237001	RV06	
D7, 9	2760057029	V06E	
D8, 10	2760280003	RB154	
PC1, 2	3939027012	PC613G	
RESISTOR GROUP			
R29	2452153008	RN14K2E560G	Metal film 1.8kΩ 1/4W
R30	2452189001	RN14K2E182G	1.8kΩ 1/4W
R28	2452195008	RN14K2E332G	3.3kΩ 1/4W
R7	2452207006	RN14K2E103G	10kΩ 1/4W
R8	2452223006	RN14K2E473G	47kΩ 1/4W
R42, 48	2440013024	RS14B3A4R7JNBF	4.7Ω 1W
VR1, 2	2116019035	K08PB203	Variable resistor 20kΩ
CAPACITOR GROUP			
C17, 18	2533619005	CC45SL1H470J	Ceramic 47PF 50V
C5, 11	2533637003	CC45SL1H271J	270PF 50V
C25, 26	2531004007	CK45B1H102K	0.001μF 50V
C3, 24, 33, 41	2531027000	CK45F1H104Z	0.1μF 50V
C4	2544129005	CE04W1A470=	Electrolytic 47μF 10V
C20	2544132005	CE04W1C100=	10μF 16V
C32, 34	2544136001	CE04W1C101=	100μF 16V
C29-31	2544032008	CE04W1E102=	1000μF 25V
C6, 7, 10 12, 19, 8	2544146004	CE04W1H010=	1μF 50V
C9	2551120084	CQ93M1H472J	Film 0.0047μF 50V
C14, 16	2551121025	CQ93M1H103J	0.01μF 50V
C23	2551074004	CQ93M1H153K	0.015μF 50V
C15	2551122008	CQ93M1H473J	0.047μF 50V
C13	2554194017	CQ93P1H473J	0.047μF 50V
C36	2558000039	CQ93P2CAC104M	0.1μF
C35	2568013058	CF99=2DAC405J	4μF
OTHER PARTS GROUP			
L1	2228436108	SERVO AMP P.C.B	
SK1, 2	3998023002	CRYSTAL	4.5MHZ
F1	2328008119	INDUCTOR	
	FEP0429K	SPARK KILLER	
	2061024023	FUSE	1.6A EU
	4178020400	HEAT SINK	
	2035622024	4P MINI CONNE PIN	
	2035622008	3P MINI CONNE PIN	
	2033625010	MINI CONNE PIN ASS	
	EE-1656	BASE TERMINAL	

• The carbon resistors rated at 1/4W are not listed herein.

CARTON CASE GROUP

Ref. No.	Part No.	Part Name	Remarks
5018207227		CARTON CASE ASS	DP-51F
5018207230		CARTON CASE ASS	DP-52F
5058119003		PACKING ASS	
5058112107		PAD	
5058092036		LAMINATE ENVELOPE	
5058017011		ENVELOPE	60x260x0.03
5058023018		ENVELOPE	350x640x0.05

ACCESSORIES GROUP

Ref. No.	Part No.	Part Name	Remarks
5298060002		45 ADAPTOR	
4218270301		RUBBER SHEET	
5118202009		INSTRUCTION MANUAL	E2, EA, EK, E1, EU
5118210004		INSTRUCTION MANUAL	EF, EG
5118209001		INSTRUCTION MANUAL	EH
3158900003		HEAD SHELL ASS	EU only
3158547001		SHELL ACCESSORY ASS	EU only
FPU-720		CARTRIDGE UNIT	E2, EF, EG, EA, EK, E1

PARTS LIST OF EXPLODED VIEW

Ref. No.	Part No.	Part Name	Remarks
1	FMD05241	INSULATOR	
2	1068076409	BOTTOM COVER	
3	4730206015	2.6x12 CBRTS (1)	
4	4730305013	3x10 CBRTS (1)	
5	4730353010	3x6 CBRTS	
6	4730309019	3x16 CBRTS (1)	
7	4178020426	HEAT SINK	
8	2228436205	SERVO AMP PCB	
9	2178028404	MOTOR ASS	
10	4730812001	3x8 CBTS	
11	4118237305	SHIELD PLATE	E1 only
	4118292007	SHIELD PLATE	
12	4770192008	SPECIAL SCREW	
13	4620027003	RUBBER BUSH	
14	2339055009	POWER TRANS	
	2339056008	POWER TRANS	E1 only
	2339048003	POWER TRANS	EU only
15	3918425004	MAGNETIC HEAD ASS	
16	4700010011	3x8 CPS W	
17	4733800010	3x8 CBTS	
18	1468129302	FRAME	
	1468129315	FRAME	E1 only
19	4498005008	CANOE RIVET	
20	3939157005	TR5005	
21	2228437107	(ARM CONTROL P.C.B)	
22	2228437107	(ARM CONTROL P.C.B)	
23	4418760200	P.C.B. HOLDER	
24	4732306010	3x12 CFTS (1)	
25	4730308010	3x14 CBRTS (1)	
26	4218261107	RECORDED TURN TABLE	
27	4218270301	RUBBER SHEET	
28	4628023009	BUSHING	
29	1318005000	DENON MARK	
30	1468130003	DUST COVER ASSY	
31	4018041002	HINGE	
32	KU-0445	MOTOR CONTROL UNIT	
	KU-0442	MOTOR CONTROL UNIT	EU only
33	4418313107	BUSHING PLATE (E)	
34	4733309032	3x16 CBRTS	
35	2065002831	AC CORD	
	2065019307	AS 3P AC CORD	EA only
	2062024006	AC CORD WITH LABEL	EK, E1 only
	2062019008	AC CORD WITH PLUG	EU only
36	4450020005	BUSHING	
	MD-2982H	CORD BUSH	EA only
	MD-3802	BUSHING	EU only
37	2033642103	OUT PUT CORD	
38	4418244108	BUSHING PLATE (C)	
39	EP7376	CORD BUSH	
40	KU-0403	ARM CONTROL UNIT	DP-51F
	KU-0410	ARM CONTROL UNIT	DP-52F
41	4730306012	3x12 CBRTS (1)	
42	3939158017	LED (AA5524S)	
43	3939159003	LED (BG5538S)	
44	3939158020	LED (BG5524S)	
45	4418764109	LED HOLDER	
46	2226437107	(ARM CONTROL P.C.B)	
47	2129059008	PUSH SWITCH	
48	2129059008	PUSH SWITCH	DP-51F
	2129183000	DOUBLE ACTION SWITCH	DP-52F
49	2118069012	V2620R25K103B103	
50	2118069009	V1620R25K104B104	
51	4418761209	VR SUPPORT	
52	EP 4772	CORD HOLDER	
53	4018054002	HINGE HOLDER	

Ref. No.	Part No.	Part Name	Remarks
54	5138203020	RATING SHEET	DP-51F
	5138203033	RATING SHEET	DP-52F
55	4751113103	4.1 WASHER	
56	4713309011	3x14 CBS	
57	4751003006	3W	
58	4998041004	C.B. LOCKING SUPPORT	
59	1018299624	CABINET ASS'Y	DP-51F
	1018299608	CABINET ASS'Y	EU only
	1018299611	CABINET ASS'Y	DP-52F only
60	1038173403	PANEL BASE	
61	1138124336	BUTTON ASS'Y	DP-52F only
62	1138124336	BUTTON ASS'Y	
63	1138124323	BUTTON ASS'Y	
64	1138125402	BUTTON ASS'Y	
65	4638613001	SPRING	
66	1038172307	FRONT PANEL	
67	1038174208	SUB PANEL	
68	1438021003	LENSE (A)	
69	1438022002	LENSE (B)	
70	2129136015	POWER SWITCH	
	2129136028	POWER SWITCH	EU only
71	4418763003	POWER SW SUPPORT	
72	4770031020	4x20 CBS(IR)	
73	4248015400	ADJUST CAM	
74	3158451003	FRICITION WASHER	
75	4751006003	5W	
76	4744201019	3x4 BSS (A)	
77	3158564000	ARMREST	
78	4733409039	4x20 CBRTS	
79	3158610103	LED LENS	
80	4438505102	SEARCH TOWER	
81	3158588206	WEIGHT KNOB	
82	3158595008	WEIGHT ASS'Y	
83	3158663201	BODY CASE	
84	3158522008	ARM PIPE	
85	4713303016	3x6 CBS	
86	4418708000	SHIELD PLATE	
87	1128077309	KNOB	
88	2228437107	OUT PUT P.C.B.	
89	4128470107	P.C.B. BRACKET	
90	4713801037	2x3 CBS	
91	4338172004	SUB SHUTTER	
92	4712304048	3x8 CFS	
93	4338169305	SHUTTER	
94	3418017200	MAGNET ASS'Y	
95	3468120008	COIL ASS'Y	
96	4338180009	YOKE (A) ASS'Y	
97	4744200010	3x6 SS	
98	4418837007	MAGNET HOLDER	
99	4638099007	SHUTTER SPRING	
100	4731803006	3x12 CPTS (-)	
101	4770182005	WASHER	
102	4438158054	COLLAR	
103	4418759004	SENER HOLDER	
104	4711312012	3x30 CPS	
105	2228437107	CDS P.C.B.	
106	3939053002	CDS 1	
107	3939053028	CDS 2	
108	4418648306	CDS HOLDER	
109	4148147009	SHEET	
110	4438470208	LED HOLDER	
111	2228437107	LED P.C.B.	
112	3939158020	LED (BG5524S)	
113	2123315010	VOLTAGE SELECTOR	E1 only
114	4711201013	2.6x4 CPTS	E1 only
115	PS-164	POWER SUPPLY UNIT	E2, EF, EG, EA, EK, E1