

A&R

A&R

A&R

A&R

A&R

A&R

A&R

The A60+ Amplifier

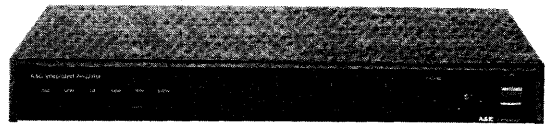

Owner's Handbook

Contents:

Introduction	1
Installing and using your A60+	2
Back panel connections	2
Front panel controls	4
Tape recording	6
Technical details	7
Spares kit	7
Connector wiring	7
Fuses	8
Removal of wooden cover	9
Cartridge loading modules	9
MC60 moving coil pre-amplifier	9
System block diagram	9
Specification	10
Inputs	10
Outputs	10
Performance	11
Typical performance graphs	12
Guarantee for UK sales	13

Introduction

The A60+ integrated stereo amplifier has been designed to provide high quality sound reproduction and to blend unobtrusively with domestic surroundings.

The amplifier has four switchable inputs accepting signals from a turntable (fitted with a moving coil or magnetic cartridge), a tuner, a Compact Disc player and either a cassette or reel to reel tape recorder. It provides outputs for a pair of loudspeakers and for headphones, and low level signals suitable for recording on to cassette and open reel tape. Additionally, in the A60AP+, the pre and power amplifier sections may be split to permit more complex systems (e.g. using ambisonics) to be assembled.

Although designed for simplicity of operation the A60+ has comprehensive tone control facilities which enable good results to be obtained with a wide variety of programme material.

Please study the manual carefully to ensure that you get the best results from your amplifier. Remember your dealer is there to help you. He has full technical and service information for all A&R Cambridge products and considerable experience of their use in a variety of systems. If, however, he is unable to answer your query then do not hesitate to contact us directly.

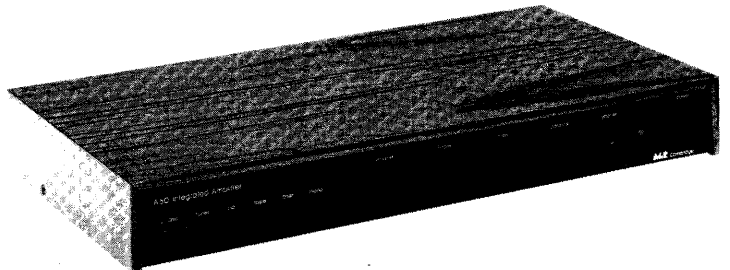

Installing and using your A60 +

Back panel connections

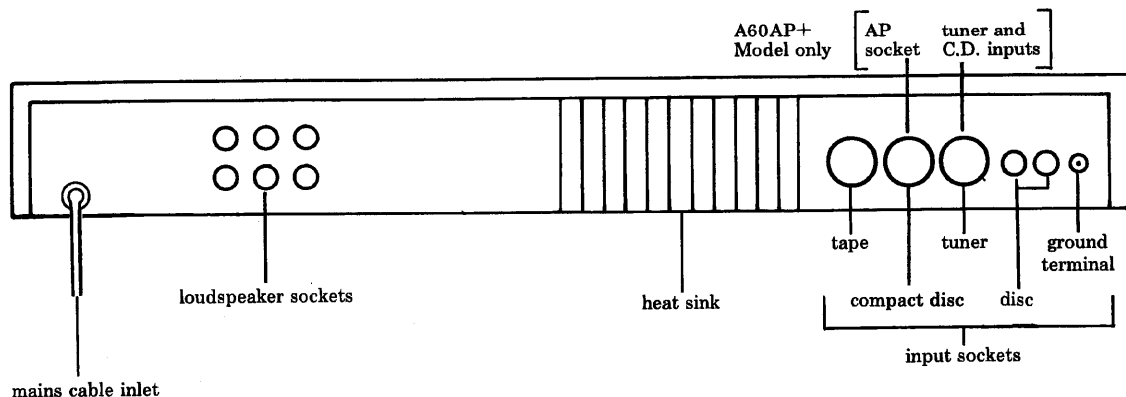

Mains supply

The amplifier is normally set up for use with a nominal 240 volt 50/60 Hz supply. It can be modified for a nominal 220 or 120 volt supply by your dealer or by the manufacturer.

The mains lead should be terminated with a three pin (earthed) plug fitted with a five amp fuse. A 1 amp anti-surge mains fuse is fitted internally. It is recommended that the supply to the A60 be disconnected when the amplifier is not in use.

UNDER NO CIRCUMSTANCES SHOULD THE AMPLIFIER COVER BE REMOVED UNLESS THE SUPPLY IS DISCONNECTED AT THE WALL SOCKET.

Do not put excessive strain on the mains cable fixing either at the amplifier or at the plug.

Loudspeakers

The outputs are suitable for driving loudspeakers of 8 ohms nominal impedance or higher. "4-8 ohm" loudspeakers, when marked as such, may also be used. "4 ohm" loudspeakers may be used if care is taken not to operate at very high levels.

The loudspeaker terminals will accept either wires or 4mm plugs. The upper set of three terminals is for the left hand speaker, and the lower set for the right hand speaker. One side of your speaker (normally the - side) should be connected to the black terminal; the other (the + side) may be connected either to the red (direct) or to the white (switched) terminal. When the "direct" output is used loudspeakers and headphones may be used together; when the "switched" output is used, insertion of a jack plug into the headphones socket will automatically mute the loudspeakers.

The A60+ is unconditionally stable and suitable for use with all types of loudspeaker leads, including the "high definition" types.

Heat sink

The heat produced by the amplifier is dissipated into the air by the heat sink, which will, along with the surrounding panel, become warm while the amplifier is on. The whole back panel may become quite hot if the amplifier is run near full power. **THIS IS PERFECTLY NORMAL.** However, if it becomes too hot to touch, switch off the amplifier at once and consult your dealer.

Disc input

The output lead from your turntable should be plugged into the disc input sockets. To prevent hum pick-up in this very sensitive input, the cable must be screened and kept well away from mains wiring. If the turntable has a separate earthing lead connected this should be attached firmly to the amplifier's ground terminal.

The disc input is normally suited to moving magnet or "high output" moving coil cartridges. If a "low output" moving coil cartridge is to be used an additional internal plug-in pre-amplifier, the MC60, must be fitted (see page 9).

The disc input impedance can be user adjusted over a wide range by fitting the (optional) ULM/M or ULM/C plug-in loading modules for moving magnet and moving coil cartridges respectively. However, most cartridges will perform satisfactorily without any loading module fitted (see page 9 for further details of cartridge matching).

Tuner input

The tuner input is suitable for use with almost any AM or FM tuner or radio.

C.D. input/auxiliary output

The C.D. (Compact Disc) input will accept any other signal, but is particularly suitable for use with a Compact Disc player. This socket also provides an output for recording onto a second cassette or reel to reel tape recorder (see page 6).

There is no C.D. socket on the A60AP+ as it is replaced by the "AP" socket (see below). The C.D. input is retained and is accessible via the spare pins of the tuner socket (see page 7). The auxiliary recording output is not available on the A60AP+.

AP socket

(pre-amplifier output/power amplifier input – A60AP+ model only)

The A60AP+ has the facility for the user to split the pre and power amplifiers into separate units. This allows signal processors (e.g. graphic equalisers) to be inserted into the signal path or more complex systems such as ambisonic (surround sound) systems to be built up.

When the pre/power amplifier split facility is not required the DIN shorting plug (supplied with the A60AP+) should be inserted into the AP socket as this links the pre and power amplifiers together so that the unit functions as a standard A60+.

Tape input/output

The tape input is designed to suit most cassette and reel-to-reel tape recorders and provides both input and output, with A/B monitoring facilities (see page 6).

Front panel controls

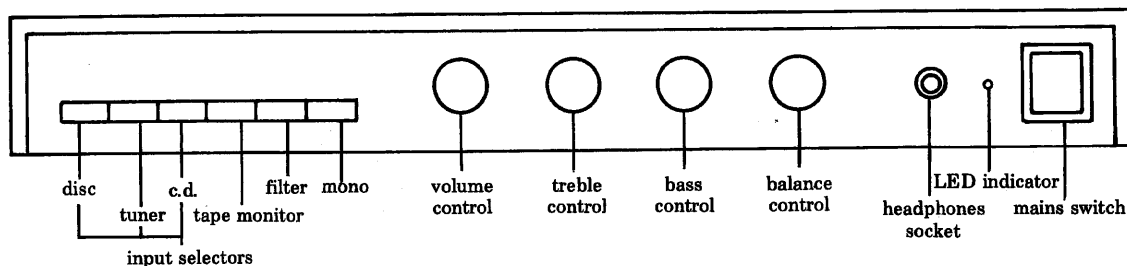

Mains power

The amplifier is turned on by the mains power switch (see illustration). It is good practice to turn the amplifier off when it is not in use.

LED indicator light

This indicates that the d.c. power supply in the amplifier is operating. It will continue to glow for a short time after the amplifier has been switched off as the d.c. voltage decays.

Input selection

The "disc", "tuner" and "C.D." switches are used to select the programme routed to the loudspeakers. By pushing any one of these buttons, you will cancel the previous setting. DO NOT attempt to push more than one button at the same time.

Tape monitoring facility

The tape monitor switch is generally left in the "off" position (switch out), so that the programme selected by the input switches is routed to the loudspeakers. When the tape button is pushed, the recorded signal from the tape recorder is routed to the loudspeakers. Further details of the tape monitoring facility may be found on page 6.

High frequency filter

When the filter switch is pushed in treble signals above approximately 7.5kHz are progressively reduced. This is extremely useful for minimising unwanted hiss from noisy tapes or poor radio reception. Under such conditions, use of this filter is generally better than simply turning down the treble control.

Mono switch

The amplifier is in its normal mode when the mono switch is out. In this position, the left and right input signals are amplified independently to appear at the corresponding loudspeaker outputs. When the mono button is pushed in, the left and right signals are mixed together and the combined signal is routed to both loudspeakers. The signals sent from the amplifier to external tape recorders, via the "tape" and "aux" sockets, are also blended into mono when the switch is in.

Volume control

The volume control adjusts the listening level on both loudspeakers and headphones.

NOTE: that each of the treble, bass and balance controls has a “click stop” in the dead centre (12 o'clock) position, to enable a flat frequency response and even channel balance to be set accurately and repeatably.

Treble control

The treble control progressively cuts treble signals when turned anti-clockwise and boosts them when turned clockwise. A “flat” frequency response is obtained when the control is set accurately to the 12 o'clock position. It is unusual to have to use this control at its extremes, i.e. outside the 9 o'clock or the 3 o'clock positions.

Bass control

The bass control progressively cuts bass signals when turned anti-clockwise and boosts them when turned clockwise. Again, the flattest response is obtained at the 12 o'clock position. The bass control in the A60+ amplifier has been designed to operate at frequencies about an octave lower than normally encountered in other amplifiers. Because of this, a significant amount of boost or cut may be employed to compensate for loudspeaker deficiencies without affecting the lower middle frequencies.

Balance control

The balance control is used to move the stereo sound image to the left or right. It can be used to compensate for imbalances in room acoustics or input signals.

Headphones socket

The headphones socket accepts any headphones fitted with a standard ¼ inch stereo jack plug. The headphones may mute the loudspeakers, or not, as required (see page 2).

Tape recording

Any tape recorder, whether cassette or reel-to-reel, may be connected to the "tape socket" and, if two recorders are to be used, the second model may be connected to the "C.D. input/auxiliary output" socket.

Tape recording using the "tape" socket

The tape socket is designed for use particularly with three-head cassette or reel-to-reel machines, although it is also perfectly suitable for use with two head machines. It is intended to be connected to the "line" inputs/outputs of these machines, which are usually accessed via phono sockets.

To record, the programme source is selected by the "disc", the "tuner" or the "C.D." button. This programme will automatically be sent to the recorder (at 5k ohm impedance). The signal to be sent to the loudspeakers can then be selected by using the "tape" button: with this button out, the selected programme source is sent to the loudspeakers. With the "tape" button pushed in, the programme being received from the tape recorder will be sent to the loudspeakers; in the case of a three head machine in "record" mode this will be the programme that is in the process of being recorded from the amplifier. Hence instant "A-B" comparison is possible between the original and the recorded signals. The replay level is adjustable in the A60+ by two screwdriver-adjustable controls accessible from inside the amplifier.

N.B. None of the amplifier controls (apart from the input selector switches) affect the signal being recorded.

To record in mono, on either a mono or stereo recorder, push the "mono" button before starting to record. Again, the signal being recorded is not affected by the amplifier controls (apart from the input selectors).

To replay via the "tape" socket simply push the "tape" button and switch the recorder into play mode.

Tape recording using the "C.D. input/auxiliary output" socket (not applicable to A60AP+ model)

When a Compact Disc player is not plugged into the "C.D. input/auxiliary output" socket, then a two head cassette or reel-to-reel tape recorder may be connected to this socket. (A two head machine is one without "A-B" monitoring, ie. replay-while-recording, facilities). To record, the "tape" button is left in the out position and the signal to be recorded is selected by pushing either the "disc" or "tuner" button. The selected signal will be sent to both the recorder (at 15k ohm impedance) and to the loudspeakers. The signal should be routed to the line inputs/outputs of the recorder, which are usually accessed via phono sockets.

DO NOT PUSH THE "C.D." BUTTON WHILE THE RECORDER IS SWITCHED INTO RECORD MODE AS THIS MAY CAUSE A FEEDBACK WHISTLE.

It is not possible to record from the "tape" input. If it is desired to record from a reel-to-reel tape recorder onto cassette, then the reel-to-reel tape recorder should be plugged into the "tuner" socket and the "tuner" button pushed.

To record in mono, on either a mono or a stereo recorder, push in the "mono" button before starting to record.

N.B. None of the amplifier controls (apart from the input selector switches) affect the signal being recorded.

To replay via the "C.D." socket, switch the recorder to play mode and push the "C.D." button. The signal from the tape will then be sent to the loudspeakers. Due to the reduced sensitivity of this input, playback will sound quieter than when using the "tuner" or "tape" inputs.

N.B. A licence may be required for recording from disc, radio or pre-recorded cassette.

Technical details.

Spares kit

You are provided with a spares kit containing the following:-

- two red and two black 4mm plugs for loudspeakers
- one 5 pin DIN plug for input sockets
- two spare speaker fuses (1.6 Amp fast blow)
- one spare mains fuse (1 Amp anti-surge)
- one Allen key ($\frac{1}{16}$ " A/F) which fits the screws in the control knobs.

Connector wiring – views from rear of plug as wired

A60 AP+ MODEL ONLY

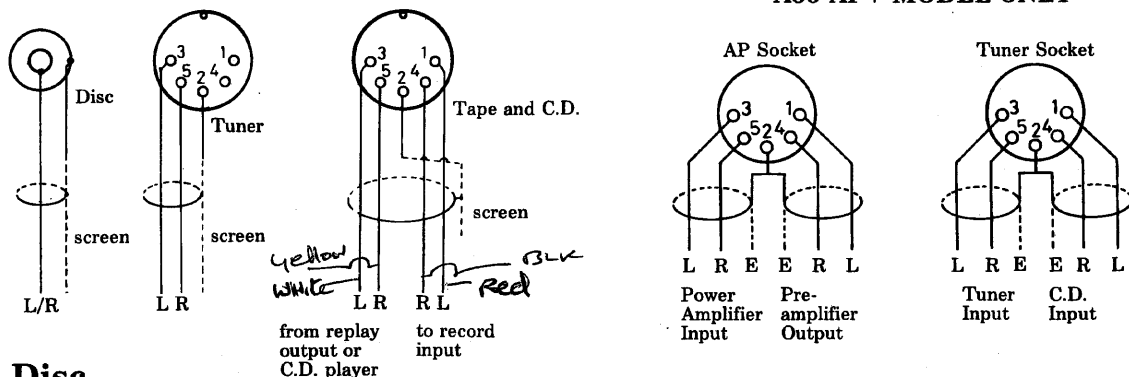

Disc

Your turntable lead should be fitted with two PHONO plugs wired as illustrated. If any other connector is fitted it should be removed and replaced by two PHONO plugs, or a high quality adaptor lead used to interface.

Tuner

A standard 5 pin 180° DIN plug to 5 pin 180° DIN plug lead such as A & R lead type L01 should be used for connection to a tuner with a DIN socket output, or a 5 pin 180° DIN plug (pins 3 & 5) to two PHONO plugs lead for a tuner with a PHONO socket output.

C.D. input/auxiliary output

When connecting a Compact Disc player with a phono socket output, a 5 pin 180° DIN plug (pins 3 & 5) to two PHONO plugs lead should be used. If the player is equipped with a fixed lead terminated in two phono plugs then a high quality twin PHONO sockets to 5 pin 180° DIN plug (pins 3 and 5) adaptor should be used (e.g. A & R lead type L02).

If a tape recorder is being used in conjunction with this socket, then the lead required here is usually a 5 pin 180° DIN plug to 4 PHONO plugs (individually screened) type. If the recorder also has a low level DIN input then a 5 pin 180° DIN plug to 5 pin 180° DIN plug (individually screened) lead may also be used successfully in most cases.

Tape

A 5 pin 180° DIN plug to 4 PHONO plugs (individually screened) lead is required.

Tuner socket (A60AP+ model only)

In the A60AP+ the auxiliary input is available at pins 1 and 4 of the tuner socket (see above). It is accessible via the A & R type L04 "Y" adaptor lead which terminates in two line DIN sockets for "tuner" and "C.D." wired as the standard A60+'s "tuner" socket (see above).

AP socket

(pre-amplifier output, power amplifier input – A60AP+ model only)

The connections to this socket are shown above. The leads required will depend upon the application, but when used with the SA60X for two way active crossover systems a 5 pin 180° DIN to 5 pin 180° DIN crossover lead (e.g. A & R lead type L03) is required.

Loudspeakers

4 mm (banana) plugs or bare wires should be used, with connectors on the other ends of the leads to suit your loudspeakers. It is important that the phasing of the loudspeakers is correct: that is, the black or – terminal of each loudspeaker should be connected to the corresponding black socket of the A60+ and the red or + speaker terminal to the red (for direct output) or white (for switched output) socket. The upper sockets are for the left hand speaker and the lower for the right. Do not make any connection between the left and right loudspeaker leads.

Fuses

Loudspeaker fuses

These are 1.6 Amp (or less) fast blow 20mm x 5mm diameter fuses. They may blow if the amplifier is:

- run continuously at high level into the correct loudspeaker load
- run at high level into a loudspeaker of too low an impedance ("4ohms" or less)
- run into a short circuit

They are user-replaceable and two spares are provided. However, if they blow consistently without any of the above conditions obtaining please consult your dealer. **DO NOT** replace with a fuse of greater value than 1.6 Amps (or with a "slow blow" or "anti-surge" fuse) since this will endanger the amplifier and your loudspeakers and invalidate your guarantee.

Power supply fuses

These are 3.15 Amp fast blow 20mm x 5mm diameter fuses. They are **NOT USER-REPLACEABLE** and spares are not supplied. If these fuses blow, there is probably a fault in the amplifier - do not change the fuses but consult your dealer.

Mains fuse

This is a 1 Amp anti-surge (slow blow) 20mm x 5mm diameter in all models. This fuse is designed to protect against faults in the amplifier, transformer and mains switch. It is not normally user-replaceable. However, should it blow during a continuous period of very high level music, or on amplifier switch-on, it may be replaced once only **WITH A FUSE OF THE CORRECT TYPE** (one spare is provided). If a second fuse blows within a short period then there is a fault, and the amplifier should be returned to your dealer.

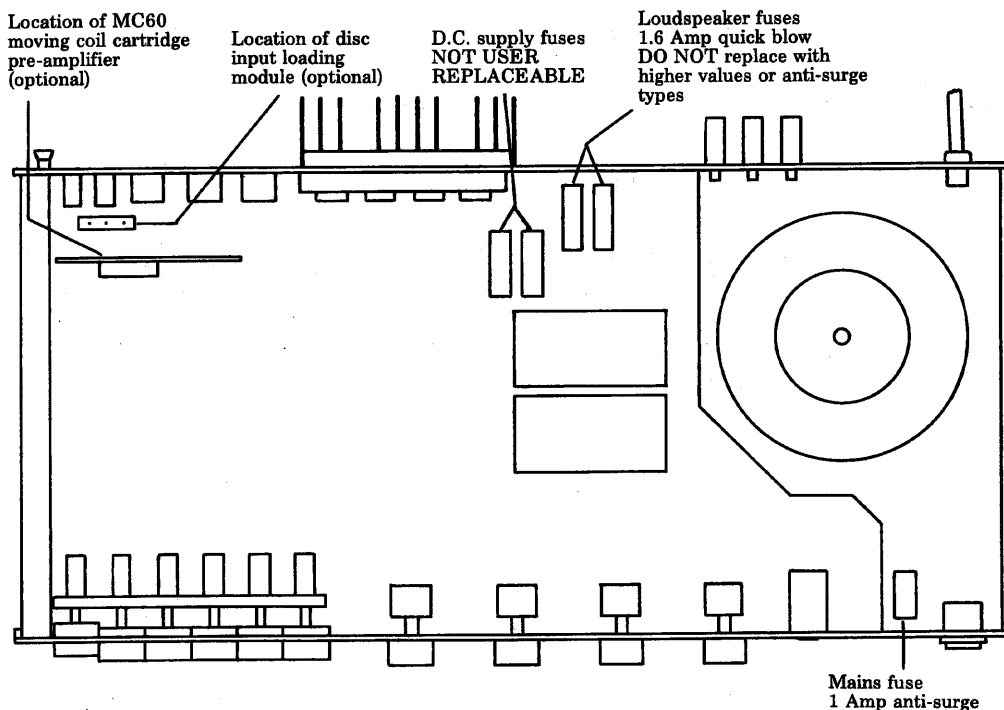

Removal of wooden cover

In order to inspect or change fuses, or adjust the tape replay level controls, you will need to remove the wooden cover from the amplifier.

BEFORE REMOVING THE COVER, ALWAYS SWITCH OFF THE AMPLIFIER AND DISCONNECT FROM THE MAINS SUPPLY.

Note that the mains fuse remains live whenever the amplifier is plugged into the mains, even when the amplifier power switch is in the off position. To remove the cover unscrew the two black-headed screws towards the rear of the side panels using a No.1 "Pozidriv" screwdriver. Then slide the cover forward as far as it will go (approximately 15mm) and lift it vertically upwards. Replacement is merely a reversal of this procedure.

Cartridge loading modules

These are purely passive modules designed to modify the input impedance of the amplifier in order to obtain the best match with the cartridge in use. The ULM/M is designed for use with moving magnet cartridges and the ULM/C (to be used in conjunction with the MC60 pre-amplifier board) is for use with moving coil types. Each is user adjustable via switches on the module and offers the facility for additional components to be wired on to provide customised loads.

The loading module should be plugged into the A60+ in the position shown in the diagram opposite.

DO NOT OPERATE THE LOADING MODULE SWITCHES WHEN THE AMPLIFIER IS SWITCHED ON. THIS MAY DAMAGE YOUR AMPLIFIER OR YOUR LOUSPEAKERS.

It must be emphasised that these passive modules mainly affect the sound balance and frequency response. They will have little or no effect on the sensitivity of the amplifier except with some moving coil cartridges where lower resistance loadings may reduce the cartridge output significantly and necessitate a higher volume control setting.

Most cartridges will perform satisfactorily without any loading module.

MC60 moving coil pre-amplifier

The MC60 is designed for use with a wide range of "low output" moving coil cartridges. Its input impedance is adjustable by using the ULM/C module as described above. To install the MC60 the following procedure should be followed:

- 1 Switch off and disconnect the mains supply to the A60+ and remove all input and output connections.
- 2 Remove the wooden cover (see above)
- 3 Remove the linking socket from the 8-way plug near the disc input socket (see diagram on page 8) and retain this in a safe place.
- 4 Insert the MC60 board into the 8-way plug ensuring that all pins engage correctly and that the board is in the correct orientation (see diagram on page 8).
- 5 Replace the wooden cover and re-connect as before.

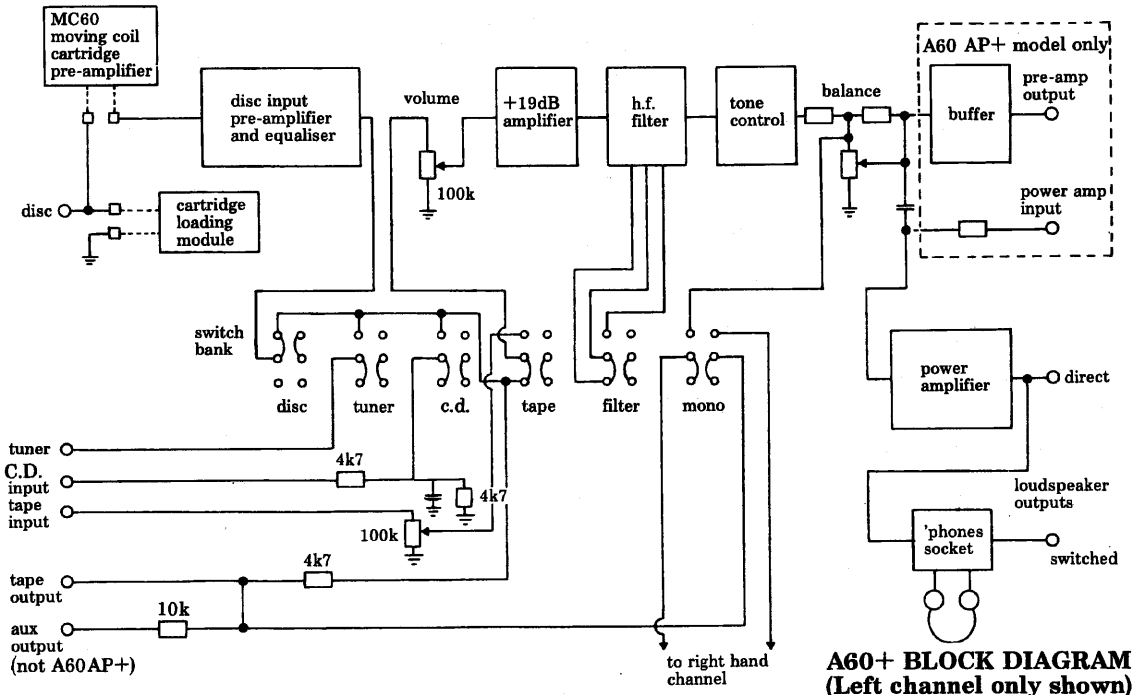

In the SYSTEM BLOCK DIAGRAM:-

- the C.D. input is at 200mV nominal level and has additional h.f. filtering to remove unwanted ultrasonic signals
- the tuner and tape are at 100mV levels and feed via the selector switch directly into the volume control
- the tape input, in addition, feeds via its own 100k ohm tape presets
- the disc input signal is amplified to 100mV to feed via the selector switch directly into the volume control
- the mono switch has two functions: it monos separately the feed to the power amplifier and the feed to the tape and aux outputs

Specifications

All input sensitivities, nominal output levels and noise figures refer to 35 watts into 8Ω at 1 kHz. All noise figures are CCIR/ARM weighted ref 1kHz. These specifications refer to both the A60+ and A60AP+ except where stated otherwise.

Inputs

Magnetic cartridge

Sensitivity 2 mV
Overload Margin $> 38\text{dB}$ 20Hz – 20kHz
Noise $< -70\text{dB}$
Frequency Response better than $+0.3\text{dB} - 0.5\text{dB}$ 40Hz – 20kHz
typically $\pm 0.2\text{dB}$ 70Hz – 20kHz, -2.5dB at 20Hz
Input Impedance $47\text{k}\Omega$, in parallel with 100pF
Switchable loading module available to provide the following additional loads: $30\text{k}\Omega$, $8\text{k}\Omega$, 200pF, 320pF, 420pF and user programmable option.

Moving coil cartridge (MC60 board fitted)

Sensitivity $100\mu\text{V}$
Overload Margin $> 38\text{dB}$ at 1kHz
Noise $< -63\text{dB}$
Input Impedance 330Ω in parallel with 1000pF
Switchable loading module available to provide the following additional loads: 100Ω , 30Ω , 10Ω , 100nF and user programmable option.

Tuner

Sensitivity 100mV
Overload Margin infinite
Noise $< -85\text{dB}$
Input Impedance $100\text{k}\Omega$

Compact Disc

Sensitivity 200mV
Overload Margin infinite
Noise $< -85\text{dB}$
Input Impedance $10\text{ k}\Omega$

Tape

Sensitivity variable via adjustable preset controls 100mV-10V
Noise $< -85\text{dB}$
Input Impedance $47\text{k}\Omega - 100\text{k}\Omega$ depending on sensitivity setting

Power amp (A60AP+ only)

Sensitivity 600mV
Input impedance $20\text{k}\Omega$
Noise $< -100\text{dB}$
Gain to Loudspeaker terminals 29dB, phase non-inverting

Tone controls

Treble up to $\pm 8\text{dB}$ at 15kHz
Bass up to $\pm 8\text{dB}$ at 50Hz
High Filter turnover frequency 7.5kHz; slope 12dB/octave, Bessel (linear phase) characteristic.

Outputs

Tape

Nominal output level 100mV
Output Impedance $5\text{k}\Omega$
Tape monitor switch allows instant A/B monitoring

Auxiliary

Nominal output level as Tape output
Output Impedance 15k Ω

Pre-amplifier (A60AP+ only)

Nominal output level 600mV
Maximum output before clipping 1.8V rms
Noise < -80dB
Distortion at nominal output level < 0.03% 20Hz-20kHz
Output Impedance 500 Ω

Headphones

Nominal output level (no load) 6.5V rms
Output Impedance 130 Ω
Suitable for headphones of 8 Ω - 2k Ω impedance

Loudspeakers

Nominal output level 35 watts into 8 Ω at 1kHz
Low frequency damping factor > 50

Performance

Power output & distortion

Both channels into 8 Ω ; > 40W at 0.2% THD 20Hz - 20kHz.
1kHz output at 0.2% THD with one channel driven is typically:
50W into 8 Ω
70W into 4 Ω
IHF burst power into 8 Ω typically 60W (4 Ω typically 90W).
1kHz THD < 0.08% at any level up to 35W/8 Ω , typically < 0.03% at 35W.

Frequency response

Disc see input facilities
Other Inputs 20Hz - 20kHz + 0.5 - 1dB reference 1kHz, output falls continuously beyond these limits.

Crosstalk

< -65dB at 1kHz.

Protection

Short term: delayed V-I electronic protection
Long term: 1.6A 20mm x 5mm quick-blow fuses.

Power supply

Maximum Load 120VA
Mains Voltage 240V nominal, range 190 - 255 volts. May be dealer adjusted to 120V nominal, range 95 - 128 volts, or 220V nominal, range 175 - 235 volts.
Operation at below the nominal mains voltage will produce a corresponding reduction in the maximum output power.

Dimensions

Width: 450mm (17 $\frac{3}{4}$ in)
Depth: 250mm (9 $\frac{9}{16}$ in)
Height: 60mm (2 $\frac{3}{8}$ in)

Weights

A60+ and A60AP+
Net 4.1Kg (9.0lb)
Packed 4.8Kg (10.6lb)

Typical performance graphs

**Tone control responses
(via line inputs)**

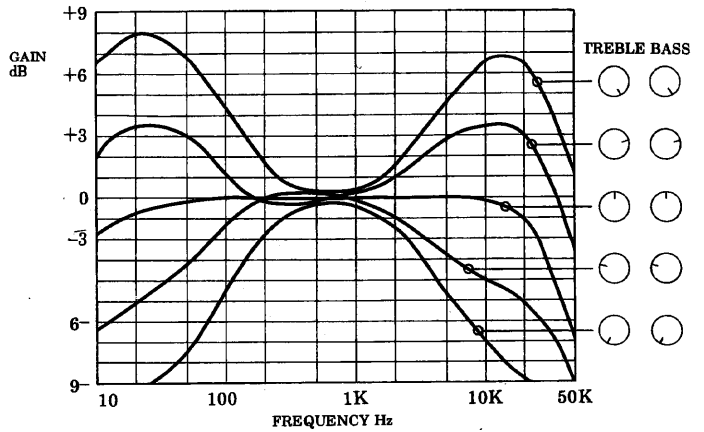

Rumble and high filter responses

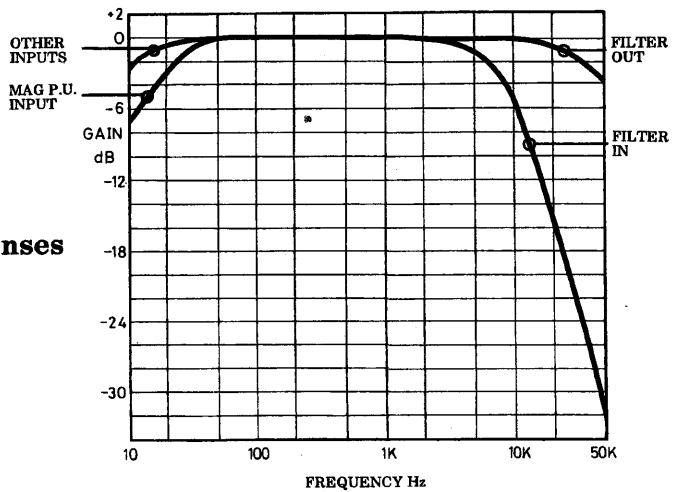

**T.H.D. vs power
output (1kHz)**

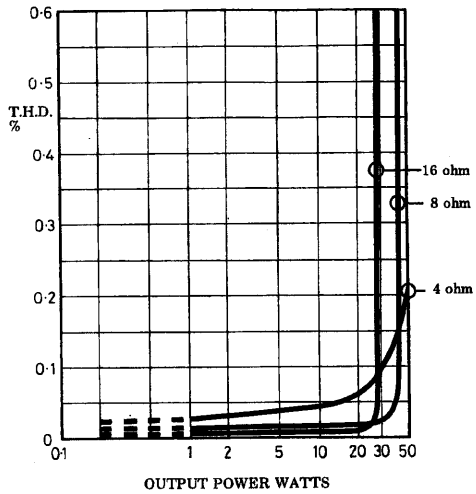

Guarantee for UK sales

This equipment has been fully tested before despatch from the factory. Both the workmanship and the performance of this equipment are (except as set out below) guaranteed against defects for a period of two years from the date of purchase provided that it was originally purchased new from an authorised UK dealer under a consumer sale agreement. (The words "consumer sale" shall be construed in accordance with Section 15 of the Supply of Goods (Implied Terms) Act 1973).

The Manufacturers can accept no responsibility for defects arising from accident, misuse, wear and tear, or neglect or through unauthorised adjustment and or repair, neither can they accept responsibility for damage or loss occurring during transit to or from the person claiming under this guarantee.

This guarantee covers both labour and parts but the liability of the Manufacturers is limited to the cost of repair or replacement (at the discretion of the Manufacturers) of the defective parts and under no circumstances extends to consequential loss or damage.

Claims under this guarantee

This equipment should be packed in the original packing and returned to the dealer from whom it was purchased or, failing this, any other authorised A&R Cambridge dealer. If it is not possible to return the equipment by hand, then it should be sent carriage prepaid by a reputable carrier.

Should the original packing not be available, replacement packing can be purchased from the Manufacturers. The equipment should not be sent by post.

DO NOT CONSIGN THE EQUIPMENT TO A&R CAMBRIDGE UNLESS YOU HAVE FIRST BEEN SPECIFICALLY REQUESTED TO DO SO BY THE MANUFACTURER'S TECHNICAL SERVICE DEPARTMENT. DO NOT UNDER ANY CIRCUMSTANCES ATTEMPT TO DISASSEMBLE THE EQUIPMENT BEFORE DESPATCH.

If you have any difficulty complying with these requirements, please contact the Manufacturers at the following address:-

A & R Cambridge Limited,
Pembroke Avenue,
Denny Industrial Centre,
Waterbeach,
Cambridge CB5 9PB.
Tel: (0223) 861550
Telex: 817345 (ARCAM G)

In either case you should state clearly your name and address, the date and place of purchase, together with a brief description of the fault experienced.

In the event of equipment being returned which on test is found to comply with the published specification the Manufacturers reserve the right to charge a reasonable fee for testing the equipment and for return carriage.

Enquiries

The Manufacturers are happy to answer any queries you may have regarding the use of this equipment on the condition that this enquiry is by letter and a stamped addressed envelope is provided. You should state clearly the serial number of the unit, the dealer from whom it was purchased and the date of purchase.

THIS GUARANTEE IN NO WAY VARIES OR REMOVES A PURCHASER'S STATUTORY RIGHTS.



Sound Reliability.

**A & R Cambridge Ltd.
Pembroke Avenue,
Denny Industrial Centre,
Waterbeach,
Cambridge CB5 9PB,
England.
Tel: (0223) 861550
Telex: 817345 (ARCAM G)**