

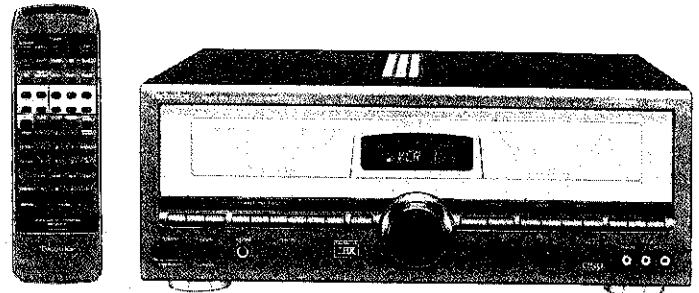

# Technics®

## Home THX Control Receiver SA-TX50

### Operating Instructions



**Note:**

The "EB" indication shown on the packing case indicates United Kingdom.

Before connecting, operating or adjusting this product, please read these instructions completely.  
Please save this manual.

# Dear Customer

Thank you for purchasing this Technics product.  
For optimum performance and safety, please read  
these instructions carefully.

## Caution for AC mains lead

### (For United Kingdom)



("EB" area code model only)

For your safety, please read the following text carefully.

This appliance is supplied with a moulded three pin mains plug for your safety and convenience.

A 5-ampere fuse is fitted in this plug.

Should the fuse need to be replaced please ensure that the replacement fuse has a rating of 5-ampere and that it is approved by ASTA or BSI to BS1362.

Check for the ASTA mark  or the BSI mark  on the body of the fuse.

If the plug contains a removable fuse cover you must ensure that it is refitted when the fuse is replaced.

If you lose the fuse cover the plug must not be used until a replacement cover is obtained.

A replacement fuse cover can be purchased from your local dealer.

#### CAUTION!

IF THE FITTED MOULDED PLUG IS UNSUITABLE FOR THE SOCKET OUTLET IN YOUR HOME THEN THE FUSE SHOULD BE REMOVED AND THE PLUG CUT OFF AND DISPOSED OF SAFELY.

THERE IS A DANGER OF SEVERE ELECTRICAL SHOCK IF THE CUT OFF PLUG IS INSERTED INTO ANY 13-AMPERE SOCKET.

If a new plug is to be fitted please observe the wiring code as shown below.

If in any doubt please consult a qualified electrician.

#### IMPORTANT

The wires in this mains lead are coloured in accordance with the following code:

Blue: Neutral, Brown: Live.

As these colours may not correspond with the coloured markings identifying the terminals in your plug, proceed as follows:

The wire which is coloured Blue must be connected to the terminal which is marked with the letter N or coloured Black or Blue.

The wire which is coloured Brown must be connected to the terminal which is marked with the letter L or coloured Brown or Red.

**WARNING: DO NOT CONNECT EITHER WIRE TO THE EARTH TERMINAL WHICH IS MARKED WITH THE LETTER E, BY THE EARTH SYMBOL  $\perp$  OR COLOURED GREEN OR GREEN/YELLOW.**

**THIS PLUG IS NOT WATERPROOF—KEEP DRY.**

#### Before use

Remove the connector cover.

#### How to replace the fuse

The location of the fuse differ according to the type of AC mains plug (figures A and B). Confirm the AC mains plug fitted and follow the instructions below. Illustrations may differ from actual AC mains plug.

1. Open the fuse cover with a screwdriver.

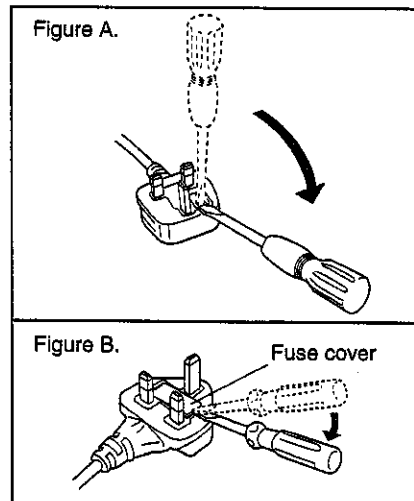

2. Replace the fuse and close or attach the fuse cover.

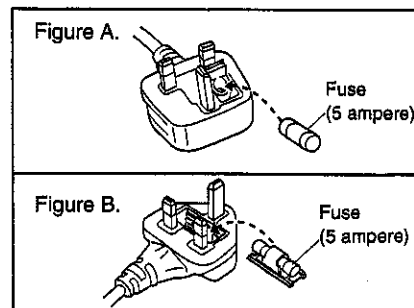

(For Australia and N.Z.)

THIS TUNER/RECEIVER IS CAPABLE OF RECEIVING THE NEW AM STEREO BROADCASTS FROM THE AM BAND RADIO STATIONS. HOWEVER LIKE MANY TUNERS AND RECEIVERS CURRENTLY AVAILABLE ON THE MARKET IT WILL REPRODUCE THIS AM STEREO SIGNAL ONLY IN AM MONO, WHICH, IN EFFECT, IS OF NO LESSER QUALITY THAN YOUR EXISTING AM MONO TUNER/RECEIVER.

# Table of Contents

Accessories .....	3
Suggestions for safety .....	4
Front panel controls .....	5
Equipment connections .....	6
Antenna connections .....	9
Speaker connections .....	11
Optional power amplifier connections .....	13
Concerning the remote control .....	13
Preparation for DOLBY PRO LOGIC operation .....	14
Adjusting the output level of each speaker .....	14
Adjusting the delay time .....	15
<b>Basic operations .....</b>	<b>16</b>
DOLBY PRO LOGIC modes .....	17
SFC modes .....	18
STEREO/MONO modes .....	19
VDP6CH mode .....	19
To adjust the tone quality .....	20
To mute the sound level .....	20
To listen through headphones .....	20
If sound output stops during use .....	20
<b>Listening to radio broadcasts .....</b>	<b>21</b>
Sequential tuning .....	21
Direct access tuning .....	21
Preset tuning .....	22

<b>Making a recording .....</b>	<b>24</b>
Recording on the VCR .....	24
Recording on the tape deck .....	24
<b>On-screen display function .....</b>	<b>25</b>
Types of displays for TV screens .....	25
<b>Sleep timer function .....</b>	<b>28</b>
<b>Remote control operation .....</b>	<b>29</b>
To operate the receiver .....	29
To operate a TV .....	30
To operate a VCR .....	31
To operate laser disc players .....	32
To operate a CD player (or CD changer) .....	33
To operate a cassette deck .....	34

<b>Troubleshooting guide .....</b>	<b>35</b>
<b>Technical specifications .....</b>	<b>Back cover</b>

## Accessories

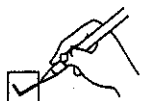

Please check and identify the supplied accessories

AC power supply cord ..... 1 pc.

(For United Kingdom) (For Australia and N.Z.)  
(VJA0733) (RJA0035-K)

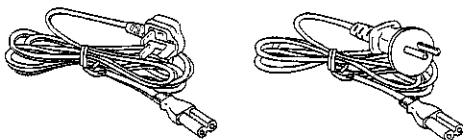

FM indoor antenna (RSA0007) ..... 1 pc.

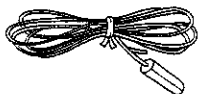

AM loop antenna set (RSA0010)

- AM loop antenna ..... 1 pc.
- AM antenna holder ..... 1 pc.
- Screw ..... 1 pc.

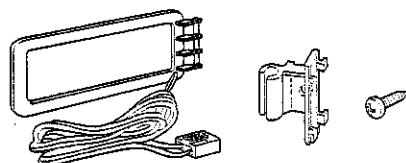

Remote control transmitter ..... 1 pc.



(RAK-SA610WH)

Attachment plug (SJP9009) ..... 1 pc.  
(United Kingdom only)



Antenna plug (RFE0014) .. 1 pc.  
(Australia and N.Z. only)

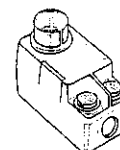

Batteries ..... 2 pcs.

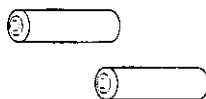

Use numbers indicated in parentheses when asking for replacement parts.

# Suggestions for safety

## Placement

Avoid placing the unit in areas of:

- direct sunlight
- high temperature
- high humidity
- excessive vibration
- uneven surfaces (Place the unit on a flat level surface.)

Such conditions might damage the cabinet and/or other component parts and thereby shorten the unit's service life.

## Ventilation

- Place the unit in a well ventilated position at least 10 cm away from wall surfaces etc.
- Ensure that curtains and similar materials do not obstruct the ventilation holes.

## Stacking

Never place heavy items on top of the unit or the power cord.

## Voltage

- It is very dangerous to use an AC power source of high voltage such as for an air conditioner.  
A fire might be caused by such a connection.
- A DC power source can not be used.  
Be sure to check the power source carefully, especially on a ship or other place where DC is used.

## Power cord protection

- Avoid cuts, scratches or poor connection of the AC mains cord, as this may result in fire or electric shock hazard.  
Excessive bending, pulling or slicing of the cord should also be avoided.
- Do not pull on the cord when you are disconnecting the power, as this could cause an electric shock. Grasp the plug firmly when you disconnect the power supply.
- Never touch the plug with wet hands or a serious electric shock could result.

## Foreign materials

- Ensure that no foreign objects, such as needles, coins, screwdrivers etc., accidentally fall into the unit or through the ventilation holes.

Otherwise, a serious electric shock or malfunction could occur.

- Be extremely careful about spilling water or liquid on/into the unit, as a fire or electric shock could occur.  
(Disconnect the power plug and contact your dealer immediately if this occurs.)
- Avoid spraying insecticides onto the unit as they contain flammable gases which can be ignited.
- Insecticides, alcohol, paint thinner and similar chemicals should never be used to clean the unit as they can cause flaking or cloudiness to the cabinet finish.

## Maintenance

Clean the cabinet, panel and controls with a soft cloth lightly moistened with mild detergent solution.

Do not use any type of abrasive pad, scouring powder or solvent such as alcohol or benzene.

## Service

- Never attempt to repair, disassemble or reconstruct the unit if there seems to be a problem.  
A serious electric shock could result if you ignore this precautionary measure.
- If a problem occurs during operation (the sound is interrupted, indicators fail to illuminate, smoke is detected, etc) contact your dealer or Authorized Service Center immediately.
- Disconnect the power supply if the unit will not be used for a long time. Otherwise the operation life could be shortened.

### CAUTION

Do not place a tape deck or CD player on top of this unit. Heat radiated from the top of this unit may cause damage to the tape or CD software.

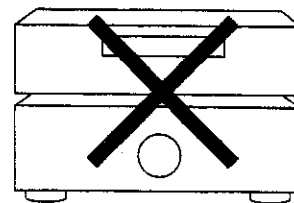

**NO**

### CAUTION!

DO NOT INSTALL OR PLACE THIS UNIT IN A BOOKCASE, BUILT IN CABINET OR IN ANOTHER CONFINED SPACE IN ORDER TO KEEP WELL VENTILATED CONDITION. ENSURE THAT CURTAINS AND ANY OTHER MATERIALS DO NOT OBSTRUCT THE VENTILATION CONDITION TO PREVENT RISK OF ELECTRIC SHOCK OR FIRE HAZARD DUE TO OVERHEATING.

# Front panel controls

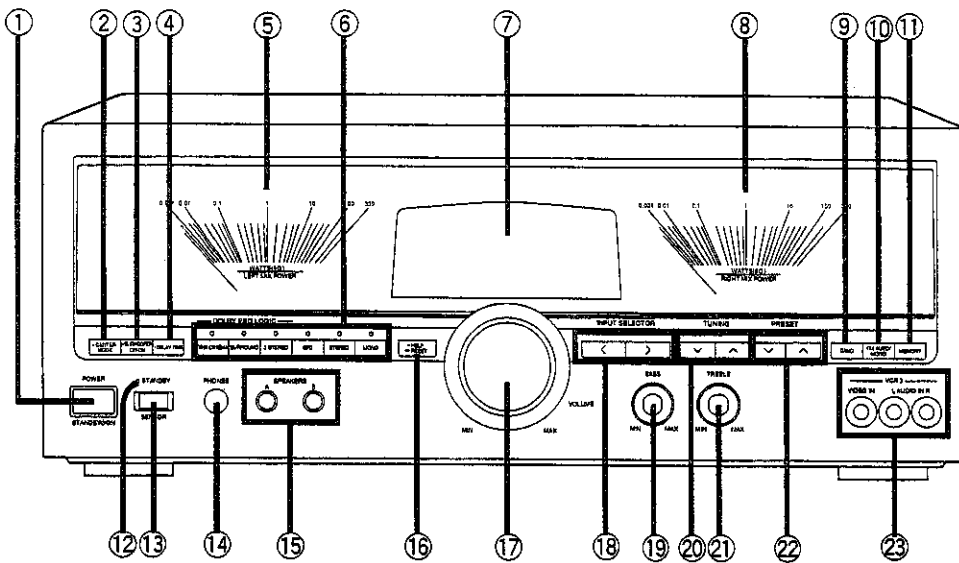

No.	Name	Ref. page
①	Power "STANDBY $\odot$ /ON" switch (POWER, STANDBY $\odot$ /ON)	16 Press to switch the unit from on to standby mode or vice versa. In standby mode, the unit is still consuming a small amount of power.
②	Center mode select button (-CENTER MODE)	14
③	Subwoofer OFF/ON button (-SUBWOOFER OFF/ON)	15
④	Delay time adjust button (-DELAY TIME)	15
⑤	Left channel power meter (LEFT MIX POWER)	-
⑥	Playback mode select buttons/indicators	16
⑦	Display	-
⑧	Right channel power meter (RIGHT MIX POWER)	-
⑨	Band select button (BAND)	21
⑩	FM mode select button (FM AUTO/MONO)	21
⑪	Memory button (MEMORY)	22, 23
⑫	"STANDBY" indicator (STANDBY)	- When the unit is connected to the AC mains supply, this indicator lights up in standby mode and goes out when the unit is turned on.

No.	Name	Ref. page
⑬	Remote control signal sensor (SENSOR)	13
⑭	Headphone Jack (PHONES)	20
⑮	Speaker select buttons (SPEAKERS)	16
⑯	Help/reset button (-HELP -RESET)	20
⑰	Volume control (VOLUME)	16
⑱	Input select buttons (INPUT SELECTOR)	16
⑲	Bass control (BASS)	20
⑳	Tuning control buttons (TUNING)	21
㉑	Treble control (TREBLE)	20
㉒	Preset channel select button (PRESET)	23
㉓	VCR 3 front input terminals (VCR 3)	8

## Power meters (⑤, ⑧)

The meters on each side of the display indicate the power mix of all the speakers combined, the left power mix on the left and the right power mix on the right.

When only the center speaker is producing sound, as is the case with monaural signals, output testing or dialogues heard in the Dolby Pro Logic playback mode, the left and right needles waver exactly the same.

## For your reference

The short and long bars found on some of the buttons indicate whether you have to press (-) the button or hold it down (-) to access/operate the function.

# Equipment connections

## Connecting audio equipment

Make sure that the power supply for all components has been turned off before making any connections.

**Note.**

Do not place books, etc., on top of this unit or block the heat radiation vents in any way.

**Stereo connection cable** (not included) (L) White (R) Red  
**Video connection cable** (not included)

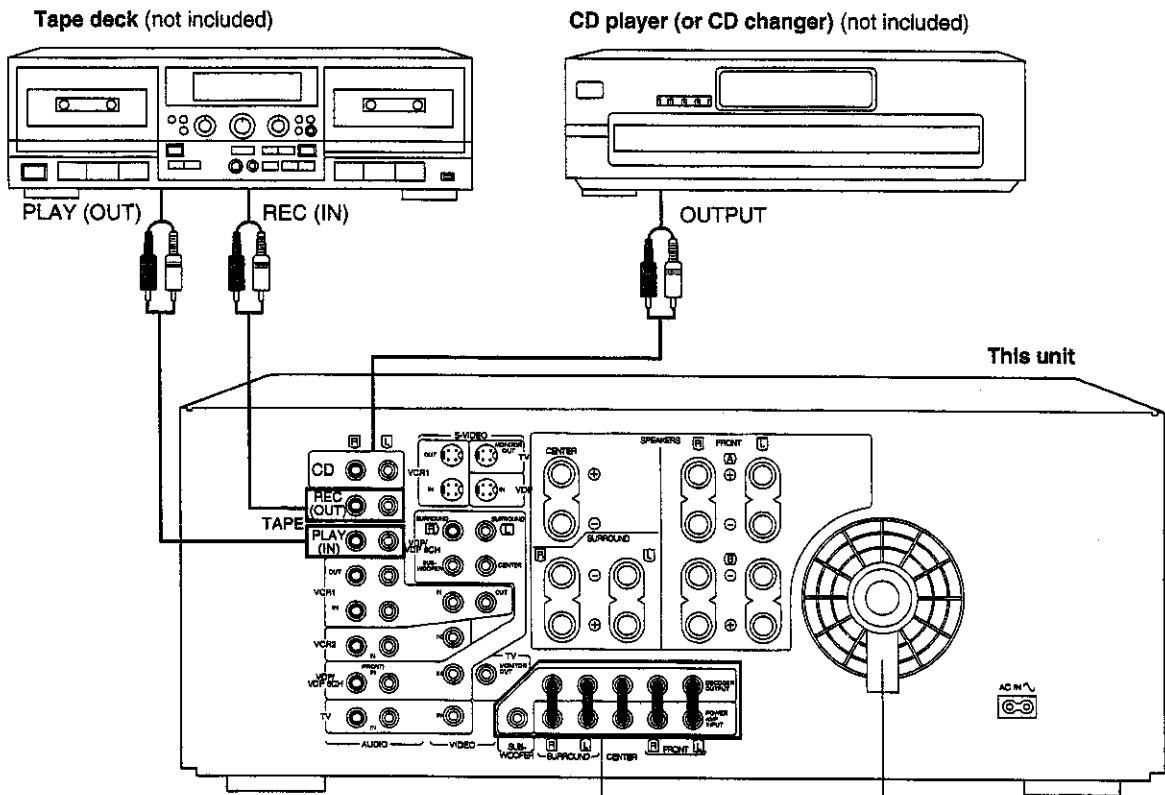

**Cooling fan**  
The cooling fan operates at high power output levels only.

**A "DECODER OUTPUT"/ "POWER AMP INPUT" terminals**

These terminals can be used in either of the following two ways.

1. For connecting a power amplifier (not included). This will allow you to enjoy amply reproduced sounds in large rooms of more than about 85 cubic meters. (See page 13.)
2. For connecting a graphic equalizer (not included). This lets you correct the sound quality of your system, such as adjusting frequency characteristics to the listening room. With a graphic equalizer, you have to use the "DECODER OUTPUT" and "POWER AMP INPUT" terminals of a specific channel whose sound quality you want to correct. Connect the "DECODER OUTPUT" terminal to the input terminal on the graphic equalizer, and the output terminal on the graphic equalizer to the "POWER AMP INPUT" terminal.

# Connecting video equipment

**Stereo connection cable** (not included)  
 (L) White  
 (R) Red

**Video connection cable** (not included)

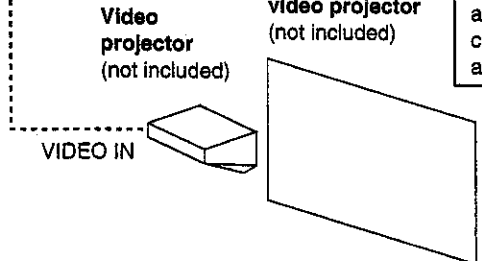
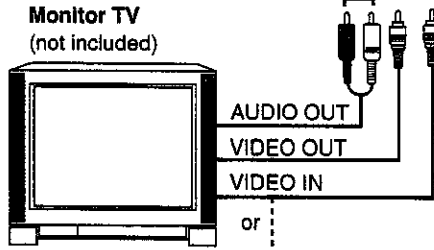
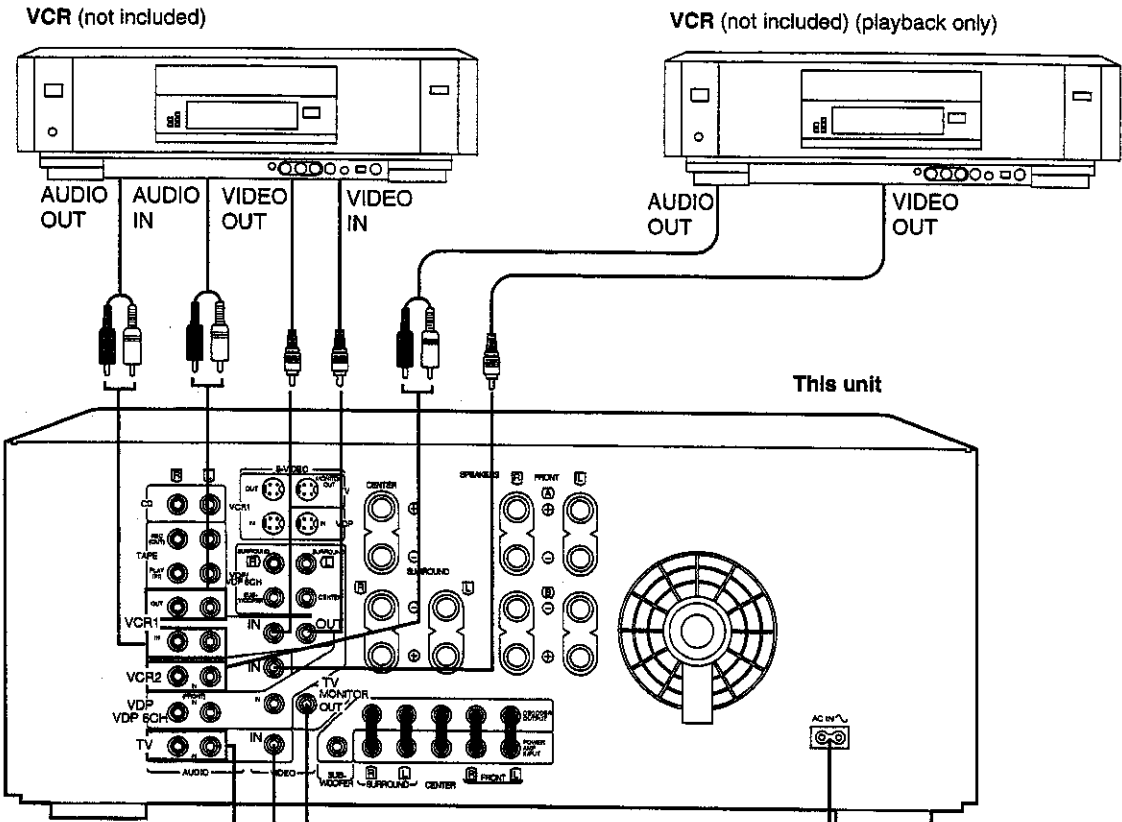

**Connector**  
 Approx. 6 mm  
 Appliance inlet

Even when the connector is perfectly inserted, the front part of the connector jut out as shown in the drawing. However there is no problem using the unit.

AC power supply cord (Included)

Connect this cord after all other cables and cords are connected.

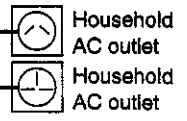

**(United Kingdom only)**  
 BE SURE TO READ THE CAUTION FOR THE AC POWER SUPPLY CORD ON PAGE 2 BEFORE CONNECTION.

# Equipment connections

## Connecting video equipment (continued)

### Connections to/from S-VIDEO terminals

This receiver has an S-VIDEO terminal for a TV, laser disc player and VCR (VCR 1 only)

To the S-VIDEO input terminal of a VCR  
 To the S-VIDEO output terminal of a VCR  
 To the S-VIDEO input terminal of a TV  
 To the S-VIDEO output terminal of a laser disc player

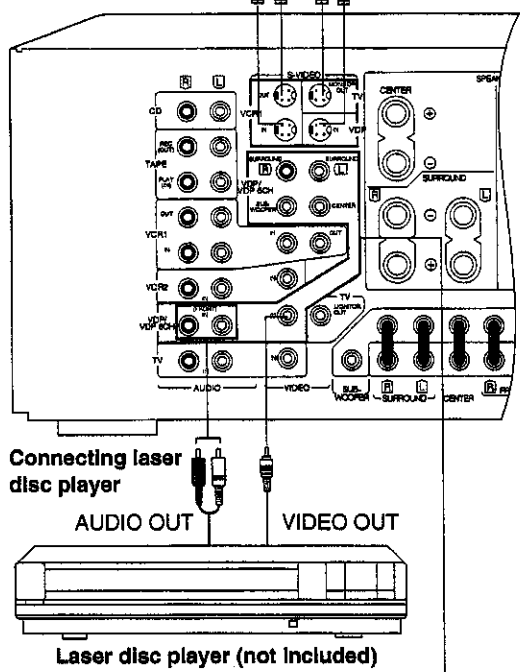

### Caution when using a TV with an S-VIDEO terminal

On some television models, the video signal from components which do not use S-VIDEO input and are connected only to the VIDEO terminals will not be shown on the television screen. If this occurs, use one of the following methods to view the video signal.

Does the television have a "VIDEO/S-VIDEO" selector switch?

- YES — Set the switch to "VIDEO".
- NO —
  - If the television has two or more video input terminals — Connect the VIDEO terminal and the S-VIDEO terminal to different video input terminals on the television, and switch the picture on the television according to the video source being played.
  - If the television has only one video input terminal — Disconnect the S-VIDEO cable connected to the television's S-VIDEO terminal and connect only the video terminal.

### Connecting components capable of 6 channel output such as AC-3 decoders

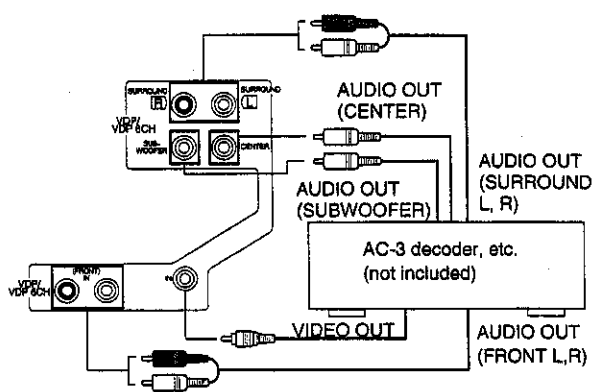

### Connecting to the front VCR 3 terminals

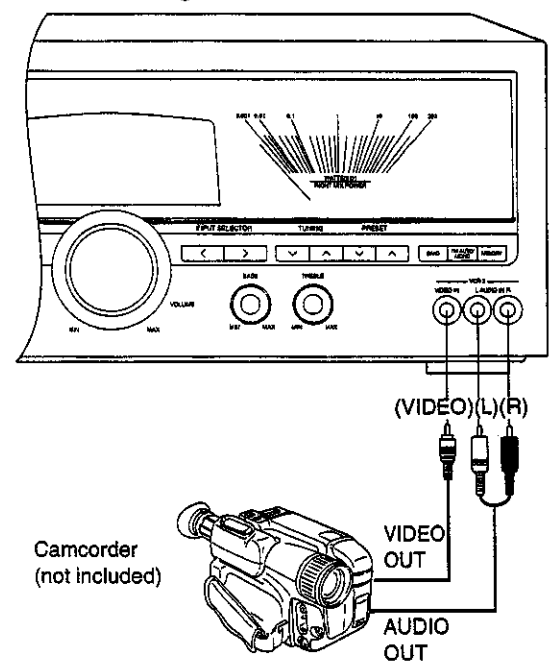



# Antenna connections

## AM loop antenna (included)

This antenna is normally sufficient for reception of MW/LW (For Australia and N.Z.: AM) broadcasts.

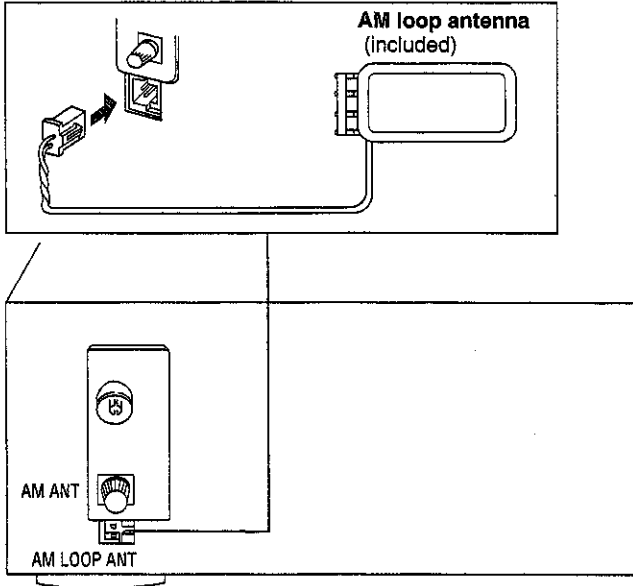

Install the AM loop antenna holder (included) at the rear panel of this unit and then attach the AM loop antenna to the AM loop antenna holder (facing in the direction of best reception).

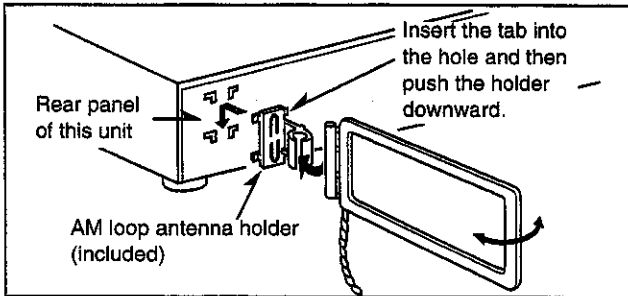

## When mounting the antenna to a column, a wall or rack

Mount it vertically.

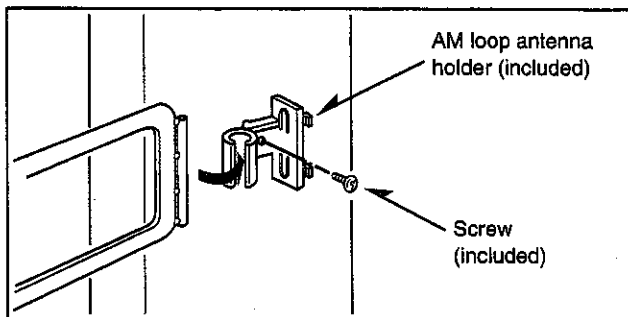

Pay attention to the following points when mounting the antenna.

- Do not mount it horizontally (doing so will impair reception).
- Do not mount it close to power cords, speaker wires or metal surfaces (doing so will result in noise).
- Do not mount it close to a tape deck. When the tape deck is being used, chirping or beeping sounds may result.

## FM indoor antenna (included)

This antenna is normally sufficient for reception of FM broadcasts.

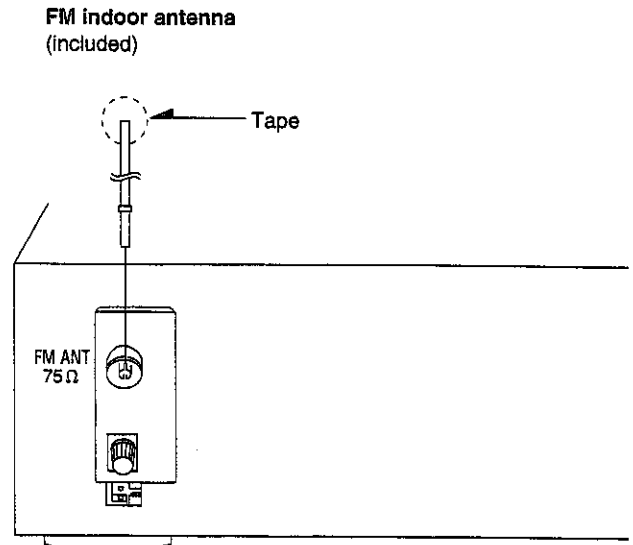

# Antenna connections

## AM outdoor antenna (not included)

The outdoor antenna should be used when using the main unit in mountainous areas or in spaces enclosed by reinforced concrete where the AM loop antenna (included) does not provide satisfactory reception.

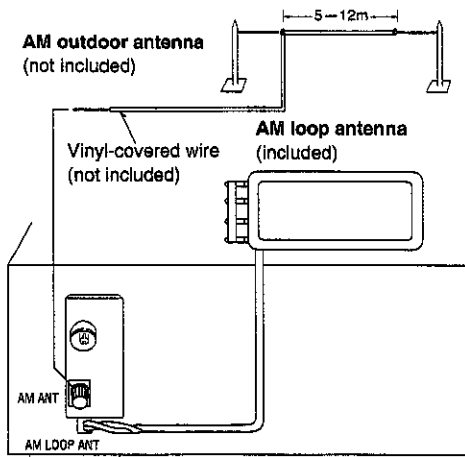

Stretch 5-12 m of vinyl-covered wire horizontally across a window frame or other convenient location, keeping it as high as possible from the ground.

When the unit is not in use, disconnect the outdoor antenna to prevent possible damage that may be caused by lightning. Never use an outdoor antenna during an electrical storm.

**Note**

Be sure to connect the AM loop antenna even when an outdoor antenna is used.

## FM outdoor antenna (not included)

The outdoor antenna should be used when using the main unit in mountainous areas or in spaces enclosed by reinforced concrete where the FM antenna (included) does not provide satisfactory reception.

**Note**

An outdoor antenna should be installed by a qualified technician only.

(For United Kingdom)  
FM outdoor antenna  
(not included)

(For Australia and N.Z.)  
FM outdoor antenna  
(not included)

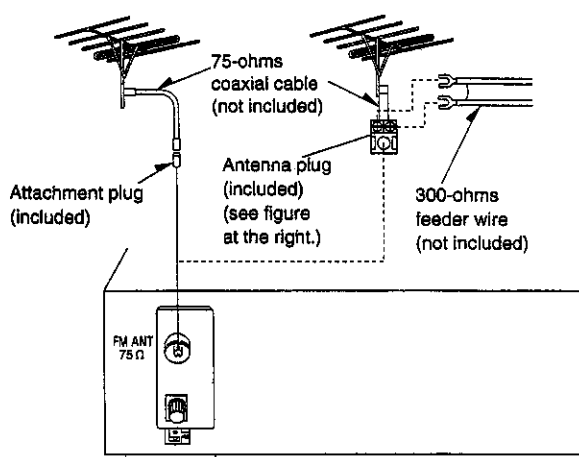

## (For Australia and N.Z.)

### How to use the antenna plug (included)

Two types of wire are most commonly used for connection from the antenna: 300-ohms parallel feeder wire or 75-ohms coaxial cable. For best resistance to outside interference, the use of 75-ohms coaxial cable is suggested.

### To connect a 75-ohms coaxial cable

- 1 Remove a piece of the outer vinyl insulator.

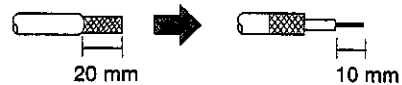

- 2 Remove the cover while pulling the tabs.

**Note**

If the tabs are pulled too hard, the casing may be damaged.

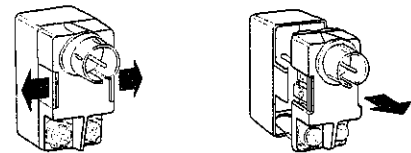

- 3 Remove the lead wire and clamp it with the plastic bar.

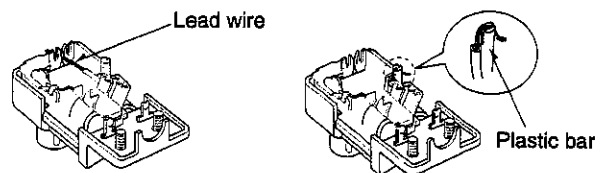

- 4 Install the coaxial cable.

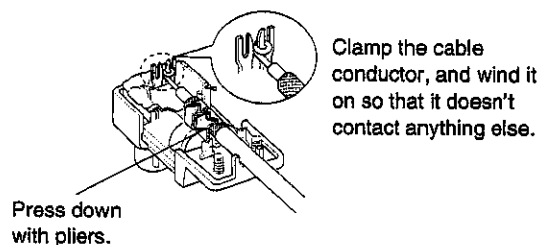

- 5 Attach the cover.

### To connect a 300-ohms feeder wire

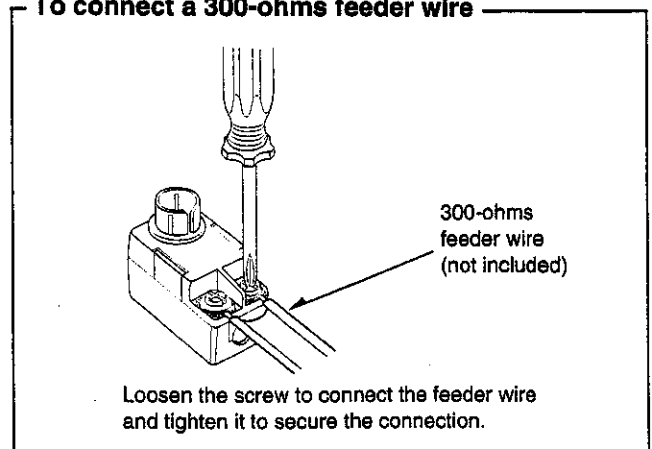

# Speaker connections

## Placement of speakers

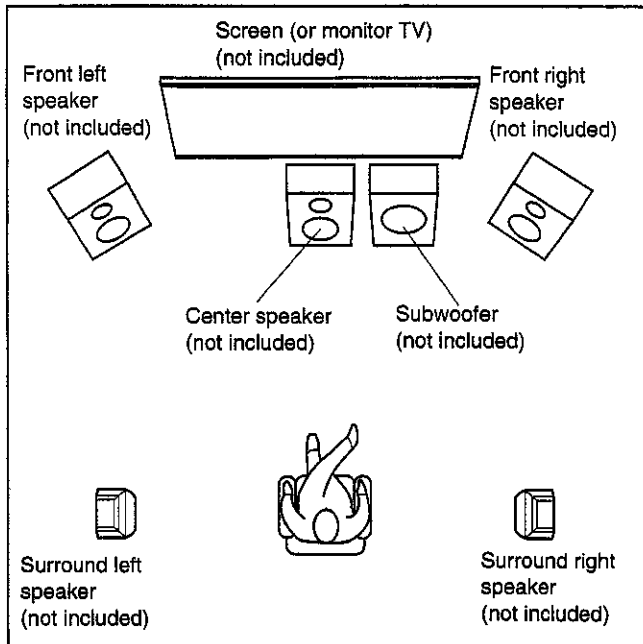

### For front speakers

Place the front left/right speakers at both the left and right edges of the screen at seated ear height so that there is good coherency between the picture and sound.

### For center speaker

Place the center speaker underneath or above the center of the screen (or monitor TV). Aim the speaker such that it is pointed at the seating area.

### For surround speakers

Place these speakers somewhere between 1.5 m–2 m from the floor on the left and right sides of the listening position.

### For subwoofer

The subwoofer can be placed in any position as long as it is at a reasonable distance from the screen or monitor TV.

Note that some experimentation in placement of the subwoofer can yield smoothest low frequency performance. Placement near a corner can increase the apparent output level, but can result in unnatural bass.

### For your reference:

The SA-TX50 will provide outstanding performance when used with any speaker system. For most accurate multichannel soundtrack reproduction, the use of a THX-certified speaker system is recommended.

## Connection of front speakers

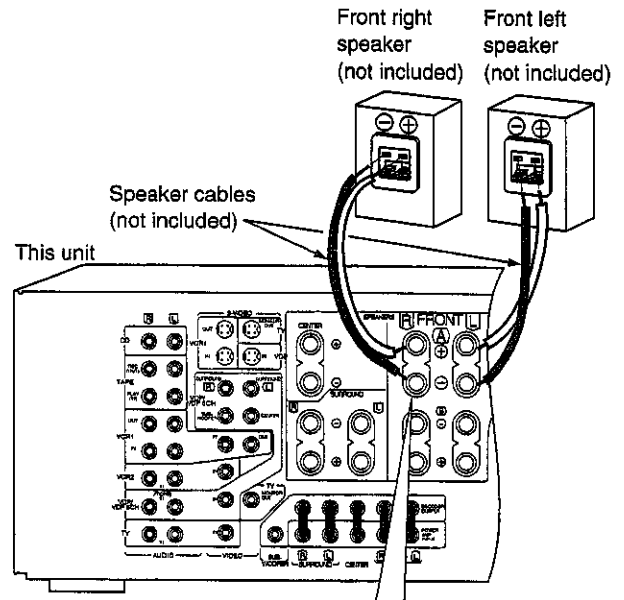

### To connect cords to terminals

- Strip off the outer covering, and twist the center conductor. 10 mm Twist
- Turn completely to the left.
- Insert the wire and turn completely to the right. Pull the cord to assure a proper connection. Be sure to only connect positive (+) cords to positive (+) terminals, and negative (-) cords to negative (-) terminals.

#### Note

To prevent damage to circuitry, never short-circuit the positive (+) and negative (-) speaker wires.

- Banana type connectors are not suitable for use with the speaker terminals of this unit.
- When connecting THX-approved front speakers, be sure to also use a THX-approved subwoofer in order to achieve a full THX system.

### ■ "B" terminals

For connection to a second pair of speakers.

### ■ Speaker impedance

**When only the "A" or "B" speakers are connected:**

The impedance of the speaker used with this unit must be 4–16 Ω.

#### Note

If speakers under 6 Ω are connected, be sure to set the impedance on the unit to LOW according to step 2 on page 14.

**When both the "A" and "B" speakers are connected simultaneously:**

The impedance of the speaker used with this unit must be 8–16 Ω.

## Speaker connections

### Connection of surround speakers

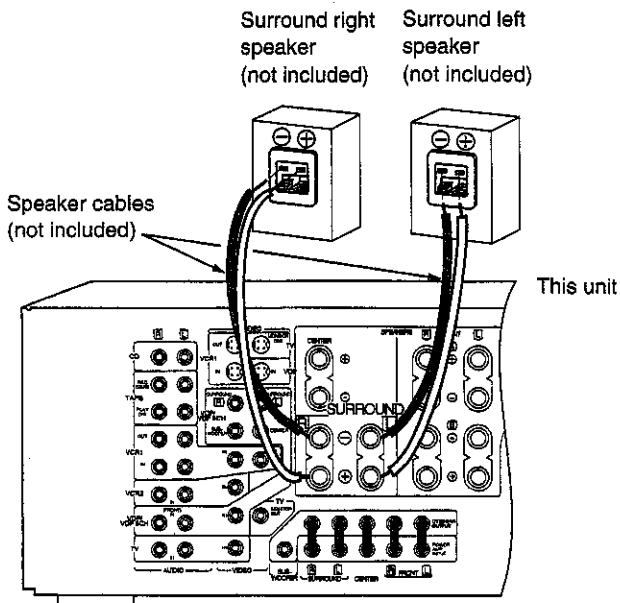

**Note**

Before sound can be heard from the surround speakers, both surround speakers must be connected.

**Speaker Impedance**

The impedance of any speaker used with this unit must be 4–16 Ω.

**Note**

If speakers under 6 Ω are connected, be sure to set the impedance on the unit to LOW according to step 2 on page 14.

### Connection of center speaker

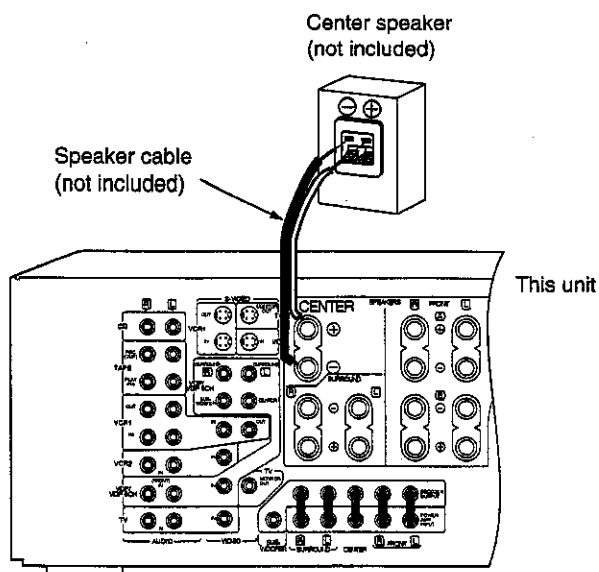

**Speaker Impedance**

The impedance of any speaker used with this unit must be 4–16 Ω.

**Note**

If a speaker under 6 Ω is connected, be sure to set the impedance on the unit to LOW according to step 2 on page 14.

### Connection of subwoofer

A subwoofer is recommended when bass sounds are inadequately reproduced from front speakers that are too small. For subwoofer placement, see page 11.

**Note**

- The SA-TX50 has no amplifier section designed especially for the subwoofer, so it is necessary to purchase a subwoofer with a built-in amplifier or buy the two separately.
- The SA-TX50 will provide outstanding performance when used with any subwoofer and power amplifier. For most accurate sound reproduction, the use of THX-certified subwoofer and power amplifier is recommended.

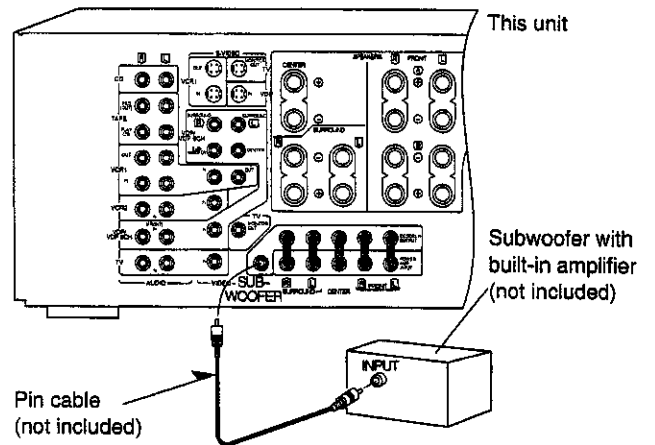

### Connecting a subwoofer which does not have a built-in amplifier

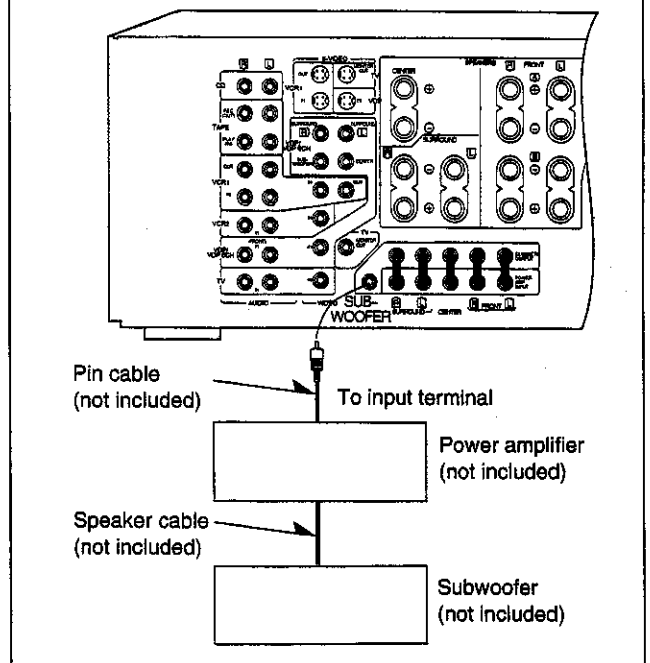

## Optional power amplifier connections

### (Using the DECODER OUTPUT terminals)

If the listening room in your home has a total volume of more than about 85 cubic meters you can best experience THX sound by connecting larger external power amplifiers (sold separately) to the "DECODER OUTPUT" terminals on the rear of this unit.

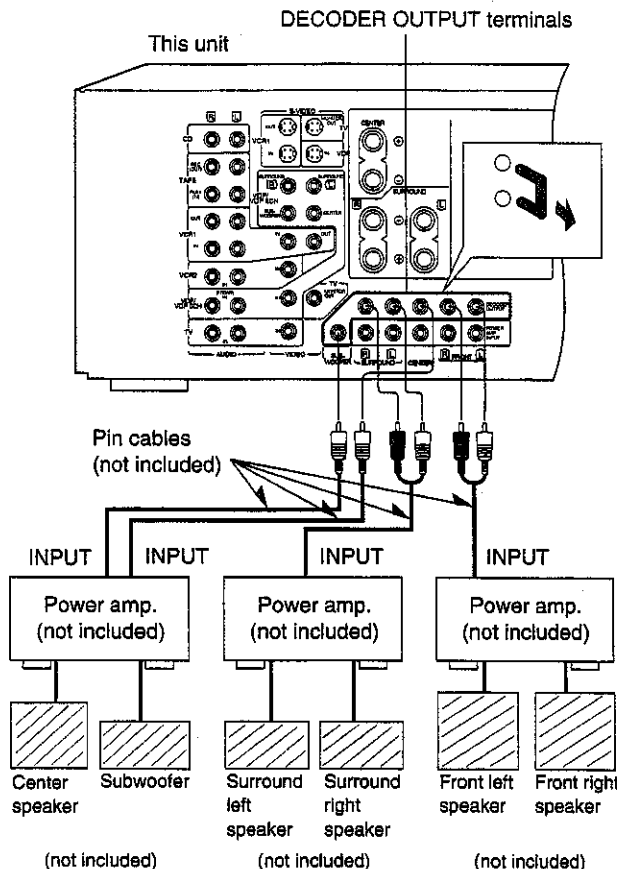

### Note when using the "DECODER OUTPUT" terminals

- In order to obtain correct multi-channel playback performance, be sure to press speaker select button A or B on the front of this unit (A and/or B will illuminate). If you do not do this (if neither A or B is illuminated on the display), sound will not come out from any speakers other than the front left/right speakers.
- The SA-TX50 will provide outstanding performance when used with any speaker and power amplifier. For most accurate sound reproduction, the use of THX-certified speakers and power amplifiers is recommended.

### When DECODER OUTPUT terminals are not in use

Be sure to insert the "shorting" pins (included).



Always insert pins top-to-bottom, never side-ways, and completely to the rear.

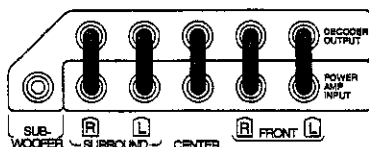

## Concerning the remote control

### Battery installation

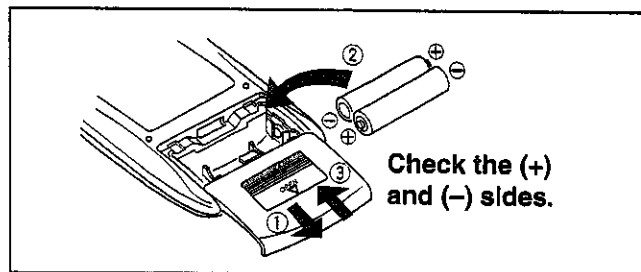

- Thoroughly clean the battery compartment before inserting new batteries.
- Do not mix old and new batteries, or batteries of different types (carbon and alkaline, etc.).
- If you will not use the remote control for a long period of time, remove the batteries and store them in a cool, dark place.
- Do not use rechargeable type batteries.
- Do not attempt to recharge alkaline or carbon batteries.
- Always remove old, weak or worn-out batteries promptly and dispose of them properly.
- Never subject batteries to excessive heat or flame; do not attempt to disassemble them; and be sure they are not short-circuited.
- If the leaking electrolyte comes into contact with skin or clothes, flush with water immediately.

### Battery life

Battery life is about one year.

The batteries should be replaced if the system fails to respond to commands from the remote control transmitter even when held close to the remote control signal sensor.

### When you need to replace these batteries

Use two R03/LR03 (AAA SIZE, UM-4) or equivalent batteries.

### Method for use

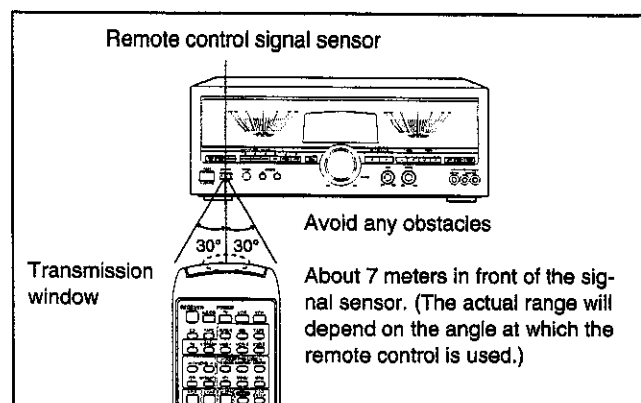

When operating a TV, VCR, laser disc player or an audio equipment with a remote control sensor, face this remote control toward the remote control sensor of the unit to be operated.

### Note

Be sure the transmission window and the unit's sensor are free from dust. Excessive dust might affect performance.

The operation may not be correct if direct sunlight or another strong light source strikes the receiving sensor of this unit. If there is a problem, place the unit away from the light source.

# Preparation for DOLBY PRO LOGIC operation

## Adjusting the output level of each speaker

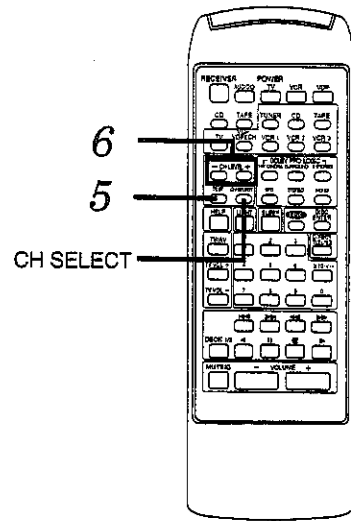
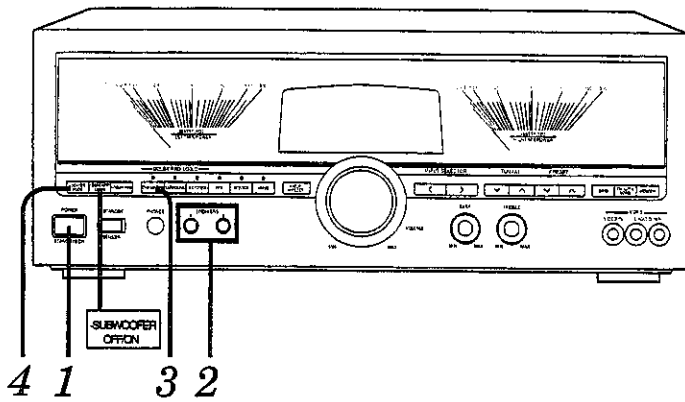

- Before operation, set VOLUME to the "MIN" position.
- When viewing a video, turn on the power supply for the TV and set the TV to video mode.
- When ready to adjust speakers output level, situate yourself away from the speakers as you normally do when listening.

**1** **POWER** Press POWER to switch on the power.

**2** **SPEAKERS** Press A or B to select the front speaker systems to be used. A and B refer to the speaker terminals at the rear of the unit.

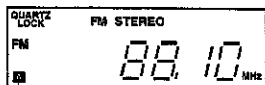

Illuminates

If the button is pressed once more, the indicator will switch off and no sound will be heard from the speakers.

### When using speakers with under 6 Ω impedance

If even one of the speakers being used has an impedance of under 6 Ω, press either button A or button B for 4 seconds or more to set the impedance on the main unit to LOW.



Illuminates

(Press once again for 4 seconds or more to turn it off.) Note that when this indicator is illuminated, speakers A and B cannot both be used at the same time.

#### To change a speaker:

e.g. To use B speaker press A (the **A** indicator goes out), and then press B to activate the B speaker.

**3** **THX CINEMA** Press THX CINEMA to turn on the THX CINEMA mode.

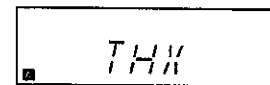

The indicator above this button will illuminate.

**4** **CENTER MODE** Press CENTER MODE to select the correct center mode.

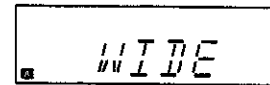

When the button is pressed, the current center mode is displayed. Holding it down again changes the center mode.

**NORM [NORMAL <SMALL>]**

When the center speaker is smaller than the front speakers

**WIDE [WIDE <LARGE/THX>]**

When the center speaker is the same size as the front speakers or when your speaker system is THX certified and includes a subwoofer

**PHAN [PHANTOM <NONE>]**

When no center speaker is connected.

**5** **TEST** **by remote control only** Press TEST to output a test signal.

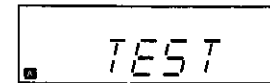

Test signal sounds automatically and switches from speaker to speaker.

You can also select a particular speaker without waiting until its turn comes, by pressing CH SELECT.

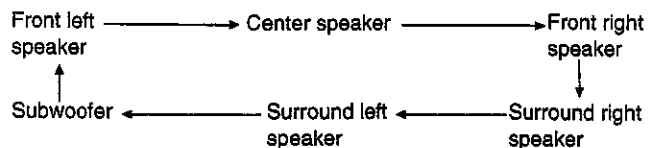





#### Note

In the PHANTOM mode, the sound from the center speaker can not be heard.

When you turn on the TV and set the TV to the video mode, the output test display will appear on the TV. (See page 27.)

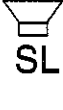

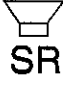
**TEST — LEVEL ADJUSTMENT**

 <b>FL</b> +10	 <b>FC</b> -1	 <b>FR</b> -12
 <b>SL</b> 0	 <b>SW</b> +5	 <b>SR</b> +1

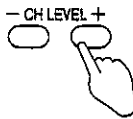
In this example, the test signal is being emitted by the front left speaker.

**6**  **CH LEVEL +**

**by remote control only**  
**Press CHANNEL LEVEL (-) or (+) to adjust the output level balance.**  
 Adjust each speaker with CHANNEL LEVEL, "+", "-" to obtain equal sound level all around.

 : Decrease the output level.  
 : Increase the output level.

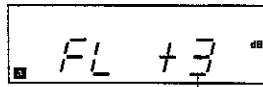

The output levels can be varied within a range of -12 dB to +12 dB.

**For your reference:**

- If you have a sound level meter, set all speakers to 75 dB SPL (C-weighted/slow mode at seating position).
- To help you balance your speakers accurately, the test signal is output at a uniform volume and is not effected by volume control settings.



**To stop the test signal**

Press TEST on the remote control.

**For your reference**

When you adjust speaker output level (steps 2-6), output level is automatically adjusted for not only the THX CINEMA mode but also the SURROUND and 3 STEREO modes.

**Note**

If you replace your front speakers after adjusting output level, playback balance may be lost depending on speaker efficiency. If this happens, simply readjust output level.

**If a subwoofer is not connected to this unit.**



Hold down SUBWOOFER OFF/ON until "OFF" appears.

To return to the "ON" condition, hold down the button until the "ON" appears.

**Adjusting the delay time**

This adjustment reduces audible crosstalk from the surround speakers so that screen sounds such as dialogue will be correctly heard from their normal position at the front.

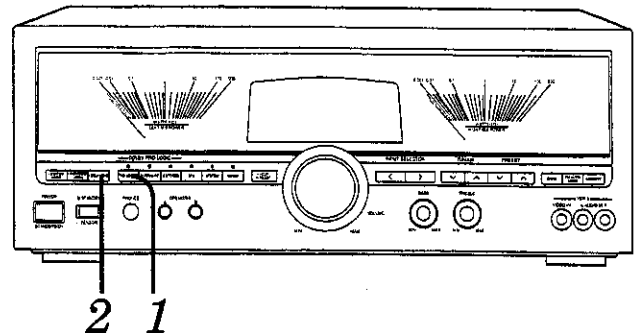

**1**  **Press THX CINEMA to turn on the THX CINEMA mode.**

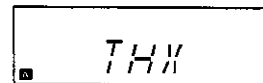

**2**  **Press DELAY TIME to set to the suitable time.**

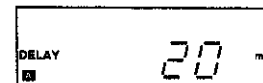

When the button is pressed, the current delay time is displayed. If you then hold it down, the delay time changes. Each time you perform this combination, the delay time will increase by 5 ms within a range of 15 ms to 30 ms. To calculate the delay time, refer to the calculation method below. The standard setting is 20 ms.

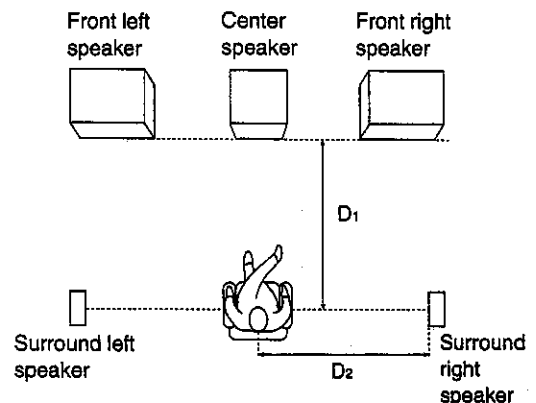

D1: Distance from front speakers  
 D2: Distance from surround speakers

- If D1 is equal to or less than D2  
 Set to 15 ms.
- If D2 is less than D1  
 Start at 15 ms and increase by 5 ms for every 1.5 m of difference between D1 and D2.

**For your reference**

When you adjust delay time (steps 1 and 2), delay time is automatically adjusted for not only the THX CINEMA mode but also the SURROUND mode.

# Basic operations

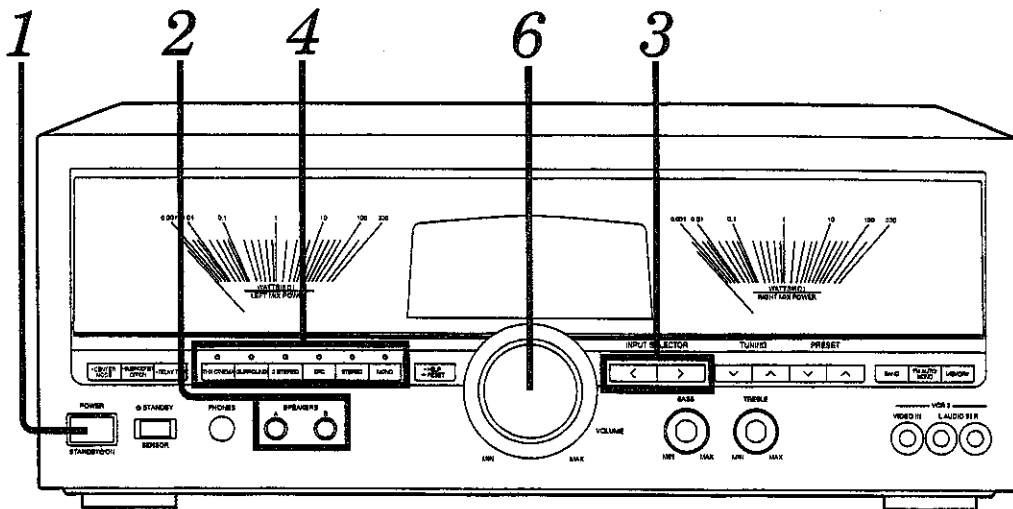

- Before operation, set VOLUME to the "MIN" position.
  - Before operation, turn on the power supply for the TV and set the TV/VIDEO mode as described below.
- To enjoy videos or laser discs**  
Set it to VIDEO mode.
- To watch TV**  
Set it to TV mode.

**1** **Press POWER to switch on the power.**

**2** **Press A or B to select the speaker system to be used.**

**Note**  
If using both speakers A and B at the same time, be sure to set the playback mode to "STEREO" (see step 4.).

**3** **Press INPUT SELECTOR (< or >) to select the desired source.**

Each time you press this button, audio and video sources will be switched as follows.

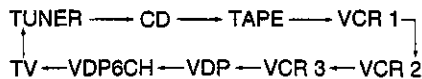

These indications correspond to terminals on the front and rear panels. Switch the displayed indication to the source you want to use.

**Note**

When you select "VDP6CH" as the input source, you do not have to perform step 4 because the playback mode is fixed for VDP6CH sources.

**4** **Press to select the desired playback mode.**

**THX CINEMA:** For motion picture program material recorded in the Dolby Surround format (See the right page.)

**SURROUND:** For program material recorded in the Dolby Surround format but which was not mixed in a film dubbing stage (See the right page.)

**3 STEREO:** For program material which has been recorded in the Dolby Surround format without the use of surround speakers (See the right page.)

**SFC:** For giving the music or movie presence and spread (See page 18.)

**STEREO:** For CD's and tapes recorded in stereo

**MONO:** For monaural recordings

**5** **Start the desired source.**

- See page 21 for listening to radio broadcasts.
- See the appropriate operating instructions for operating optional equipments.

**6** **Turn VOLUME to adjust the volume level.**

**For your reference**

If you want, you can reproduce the same volume used in dubbing stages. To do so, set output level from all your speakers to 75 dB SPL (see step 6 on page 15). Watch the sound level meter to get an accurate setting. And, select the THX CINEMA mode (step 4 on this page). Finally, and most importantly, set volume control to "REFERENCE".

**After listening is finished**

Be sure to reduce the volume level, and switch the power to the standby condition by pressing POWER.



## DOLBY PRO LOGIC modes

There are three modes of operation. BEFORE using any of them, be sure you make all the preparations explained on pages 14 and 15.

### THX CINEMA

This mode faithfully reproduces motion picture program material which has been recorded in the Dolby Surround format.

It achieves this by recreating the sonic qualities of film studio sound recording stages (known as the dubbing stage).

Home THX systems provide home viewers with the same degree of sound quality as the THX theater sound systems created by Lucasfilm Ltd. By combining this sound with the picture on a wide screen, this mode lets you enjoy a true home sound system with full intensity and feeling of "being there".

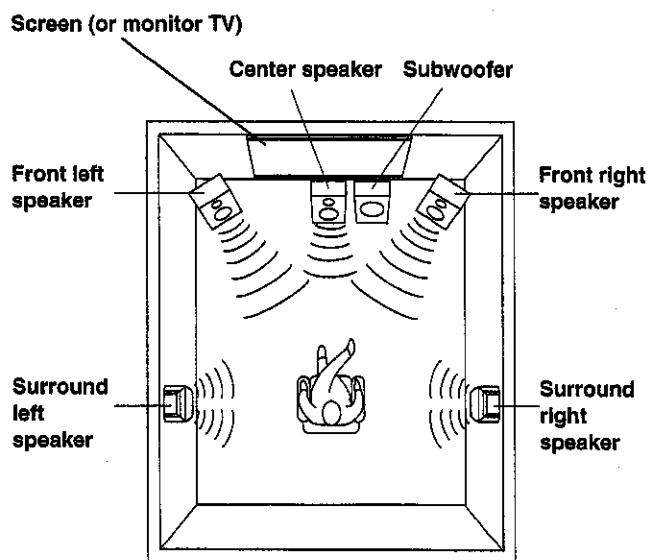

### 3 STEREO

This mode reproduces program material which has been recorded in the Dolby Surround format without the use of surround speakers. Also music and news programs can be heard with better clarity and localization.

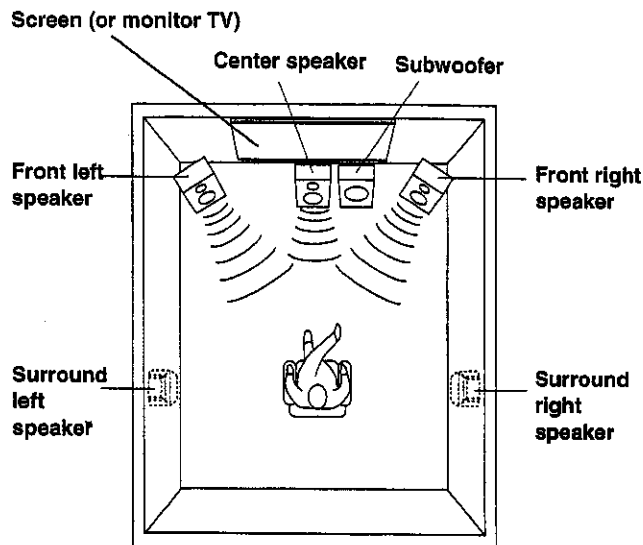

Manufactured under license from Dolby Laboratories Licensing Corporation.  
DOLBY, the double-D symbol  and "PRO LOGIC" are trademarks of Dolby Laboratories Licensing Corporation.

### SURROUND

This mode is for program material which has been recorded in the Dolby Surround format but which was not mixed in a film dubbing stage. By reproducing the feeling of depth and movement of sound, video software or compact discs recorded with Dolby Surround provide the listener with a feeling of "being there".

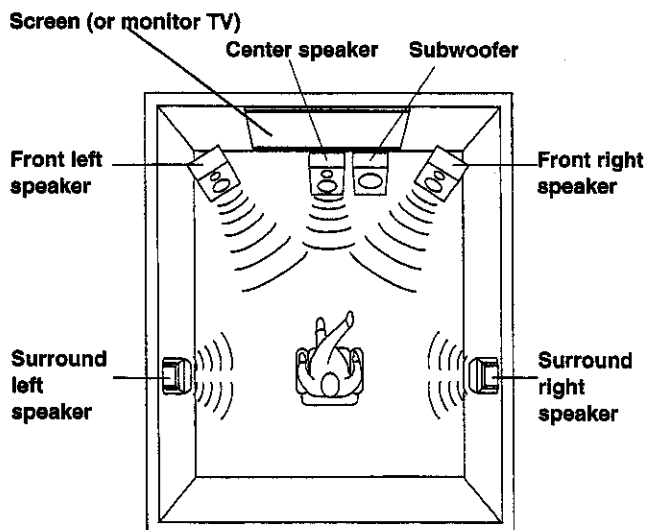

## Basic operations

### SFC modes

The SFC (Sound Field Control) function gives presence and spread thereby enhancing and enriching the music or movies not recorded in Dolby Surround.

Read the explanations below in order to better understand how to make your selection.

#### HALL

This mode imparts a reflection and spread which will make you feel as if you are in a large concert hall.

#### CLUB

Like a jazz club, this mode provides an exciting and intimate atmosphere. It simulates the sound field of a relatively small room having a low ceiling and hard reflective surfaces, for a "live" sound with enhanced presence to bring the performers up close.

#### LIVE

Primarily for vocal pieces, this mode adds gloss to the vocals and you'll feel as though you were hearing a live stage performance.

#### THEA (THEATER)

You can clearly perceive the directions and source of the movie. Real ambience of sound can also be recreated naturally using this mode.

THEATER mode can be used with stereo sources not encoded with DOLBY SURROUND.

#### Note

When using Dolby Surround encoded source materials, select the DOLBY PRO LOGIC mode.

#### CHURCH

When listening to the sound of the pipe organ, harpsichord, etc., this mode is most effective to create the rich reverberations you would hear if you were in a church.

#### STADIU (STADIUM)

When listening to baseball or football broadcasts, this function automatically sets the appropriate bass level for the announcer's voice (mono) and audience cheers (stereo).

#### SIMU (SIMULATED)

You can feel as if you were in a more expanded space adding to the actual sound from the source. This mode also adds effect to monaural sources by outputting the sound from surround speakers.

#### SSI 1

This mode provides the natural ambience of a concert hall, ideal when listening to orchestral performances.

#### SSI 2

This mode offers a stronger surround sound effect than SSI 1.

#### SSI 3

This mode adds a center channel for vocals positioned in the center, and a stronger surround effect for an exciting "live" atmosphere.

#### For your reference

SSI is short for Sound Stage Imaging.

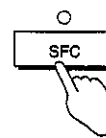
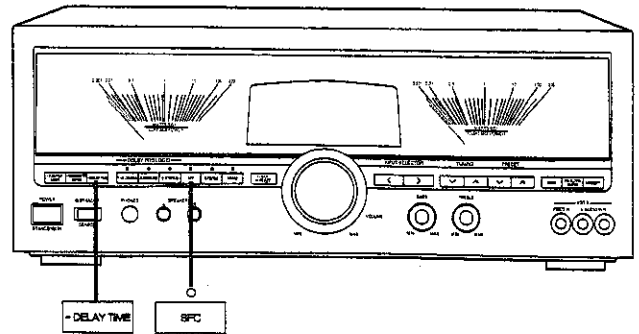

Press SFC to turn on the SFC function (Indicator will illuminate) and select the desired mode.

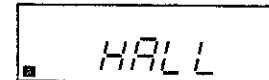

When the button is pressed, the current mode is displayed. Each time you press this button, SFC modes will be switched as follows.

HALL → CLUB → LIVE → THEA (THEATER) → CHURCH  
↑ ↓  
SSI 3 ← SSI 2 ← SSI 1 ← SIMU (SIMULATED) ← STADIU (STADIUM)

### To listen to any source in the field of sound you like

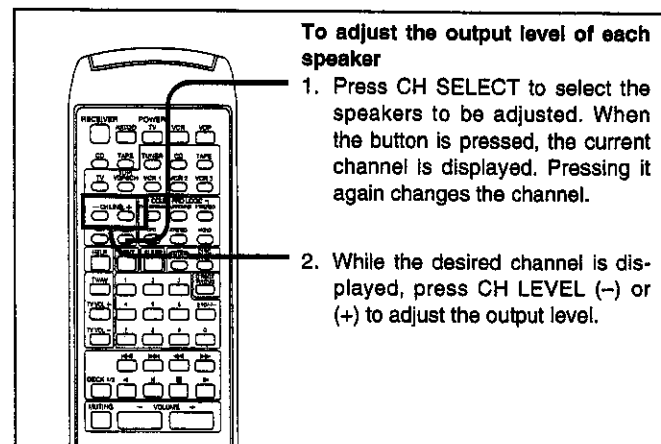

To adjust the output level of each speaker

1. Press CH SELECT to select the speakers to be adjusted. When the button is pressed, the current channel is displayed. Pressing it again changes the channel.

2. While the desired channel is displayed, press CH LEVEL (-) or (+) to adjust the output level.

### To adjust the delay time **SFC modes only**

Adjust sound spread. As a yardstick, remember that the higher the number on the display, the greater the spread.

Press DELAY TIME on the receiver to set the suitable time.

When the button is pressed, the current delay time is displayed.

Holding it down again changes the delay time.

## STEREO/MONO modes

**STEREO:** For CD's and tapes recorded in stereo  
**MONO:** For monaural playback or recordings

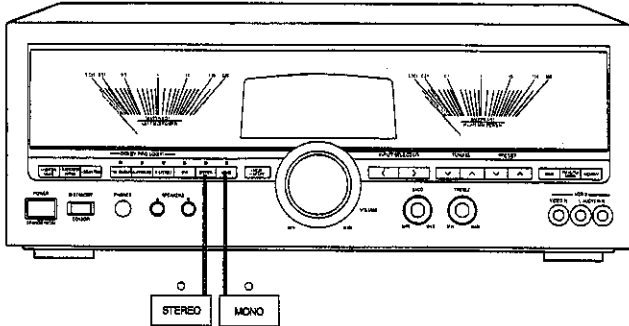

Press **STEREO** to turn on the **STEREO** mode.

The indicator will illuminate.

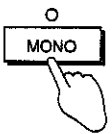

Press **MONO** to turn on the **monaural** mode.

The indicator will illuminate



## VDP6CH mode

This is the playback mode you want in order to enjoy components capable of discrete 6 channel output like AC-3 decoders, etc.

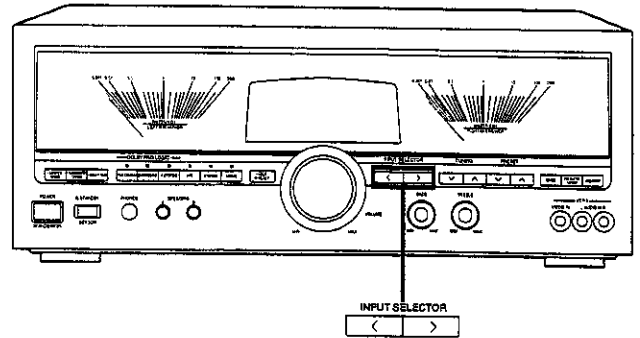

Before operation, adjust speaker output level in the same way as explained on pages 14 and 15. In this case, the system saves the setting in memory as the VDP6CH level.

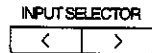

Press **INPUT SELECTOR (<)** or **(>)** to select "**VDP6CH**".

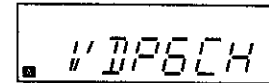

### Note

When you select this mode, the stereo automatically turns OFF all other playback modes. So, there is nothing else you can select. To change to another mode, set the input source to something other than "VDP6CH"

### For your reference

For details on how to operate components capable of 6 channel output such as AC-3 decoders see the instruction manual that came with the component.

Operation modes		Speakers available for level adjustment	Variation range (dB)	Available delay time setting (ms)
SFC	HALL	FL, FR, SR, SL, SW	-12 to +12	10, 20, 30, 40, 50, 60
	CLUB	FL, FC, FR, SR, SL, SW	-12 to +12	5, 10, 15, 20, 25, 30
	LIVE	FL, FC, FR, SR, SL, SW	-12 to +12	20, 25, 30, 40, 50, 60
	THEA (THEATER)	FL, FC, FR, SR, SL, SW	-12 to +12	15, 20, 25, 30, 40, 50
	CHURCH	FL, FR, SR, SL, SW	-12 to +12	—
	STADIU (STADIUM)	FL, FR, SR, SL, SW	-12 to +12	60, 80, 100, 120, 140
	SIMU (SIMULATED)	FL, FR, SR, SL, SW	-12 to +12	5, 10, 15, 20, 25, 30
	SSI 1	—	—	—
	SSI 2	—	—	—
	SSI 3	—	—	—
STEREO		FL, FR, SW	-12 to +12	—
* MONO		FL, FC, FR, SW	-12 to +12	—
VDP6CH		FL, FC, FR, SR, SL, SW	-12 to +12	—

\* In the mono mode you cannot adjust output level from the left/right front speakers (FL/FR) when the center mode is set to "WIDE [WIDE <LARGE/THX>]".

## Basic operations

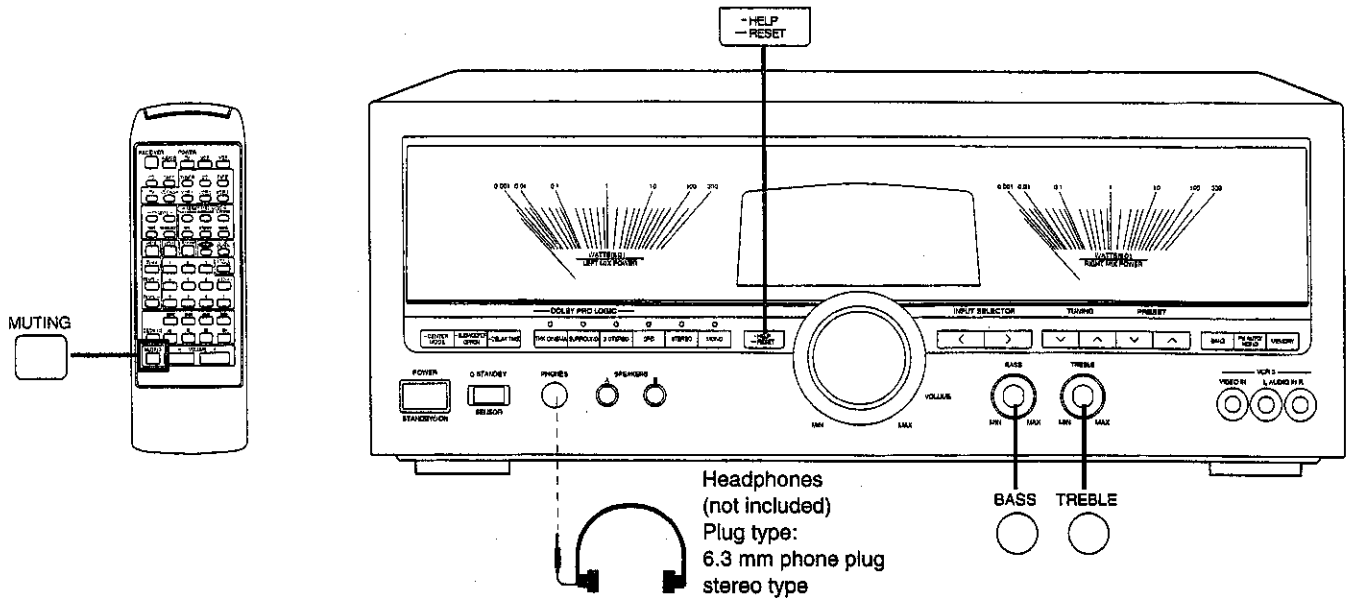

### To adjust the tone quality



Turn **BASS** to adjust the low frequency sound of the front left and right speakers.



Turn **TREBLE** to adjust the high frequency sound of the front left and right speakers.

**Note**

The above controls do not work in the DOLBY PRO LOGIC (THX CINEMA, SURROUND, 3 STEREO) mode and the MONO mode.

### To mute the sound level

by remote control only

MUTING



Press **MUTING**.



The message "MUTING ON NOW" runs repeatedly from right to left across the display as long as the muting function is on.

Press once again to return to the previous volume level.

**Note**

When the receiver is turned off, the muting operation will be automatically cancelled.

### To listen through headphones

Use **VOLUME** to reduce the volume level, and connect the headphones.

If sound from speakers is not wanted, press **SPEAKERS (A)** and/or **(B)** to turn off the speaker select indicators.

If you turn **OFF** both sets of speakers (A and B), you get normal stereo playback from the headphones with all playback modes.

**Note**

Avoid listening for prolonged periods of time to prevent hearing damage.

### If sound output stops during use

If you make a mistake in operation or if sound output stops due to some operation which was performed, the HELP function displays characters which can be useful for indicating the method by which this condition can be remedied.

If "ERROR" or scrolling characters (for instance, "MUTING ON NOW") appear on the display during operation, carry out the following operation.



Press **HELP**. (Touch only.)

The method for remedying this condition will be displayed.

### For your reference:

If the above button is pressed for a longer period until "RESET" appears on the display, the operation settings for the unit will be initialized to the settings made at the time of shipment.

However, any broadcasting stations which have been preset into memory will not be erased at this time.

# Listening to radio broadcasts

## Sequential tuning

You can use the tuning buttons to tune-in radio broadcasts.

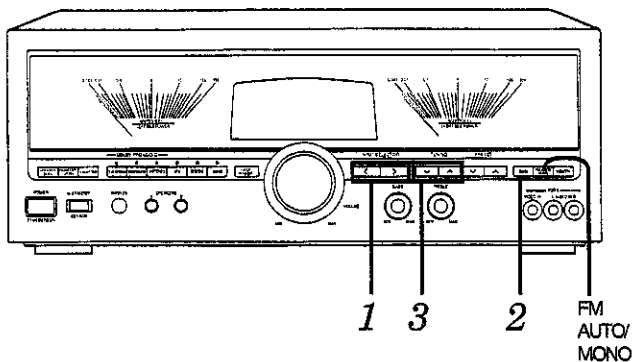

**1** **INPUT SELECTOR** Press INPUT SELECTOR (< or >) to select "TUNER".

**2** **BAND** Press BAND to select "FM", "MW" or "LW". (For Australia and N.Z.: FM or AM)

**3** **TUNING** Press ∨ or ∧ to tune to the desired broadcast.

If either button is held down for an instant until the frequency begins to scroll, the broadcast stations can be tuned in automatically when a broadcast station is found.

**Note**  
Tuning may stop automatically if any jamming is encountered.

Lights up when tuned  
Lights up when an FM stereo broadcast is received

Frequency display

### If noise is excessive in the FM stereo mode

Press FM AUTO/MONO. (The "FM STEREO" indication will go out.)

The broadcast will be monaural, but noise will be reduced. If the button is pressed once more, the stereo mode will be resumed.

**Note**  
When the receiver is turned off, the monaural mode will be automatically cancelled.

## Direct access tuning

by remote control only

Specify the frequency using the numeric buttons on the remote control transmitter to directly tune to the desired broadcast station.

### Preparation

First select between FM, MW or LW with the BAND button on the receiver. (For Australia and N.Z.: FM or AM)

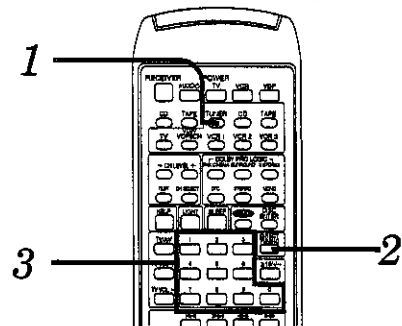

**1** **TUNER** Press TUNER.

This will set the remote control to operate the receiver.

**2** **DIRECT TUNING** Press DIRECT TUNING.

Flashes

While cursor display is flashing (approx. 10 seconds)

**3** Press the appropriate numeric buttons to enter the frequency.

If the desired FM frequency is 107.90 MHz  
1 → 0 → 7 → 9 → 0

If the frequency has been input correctly, the displayed frequency will blink once.

### Note

1. If no button is pressed while the cursor display is flashing, the display will return to the frequency which is currently being received. To re-specify the frequency, repeat the procedure from step 2.
2. If the frequency has not been input correctly, "ERROR" indication will be displayed. In this case, re-enter the frequency.

## Preset tuning

By presetting the desired broadcast stations into the memory channels of this unit, broadcast stations can be selected simply by pressing numeric button(s).

### Before presetting

#### How many broadcast stations can be preset?

##### For United Kingdom

A total of 30 FM, MW and LW stations can be preset.

##### For Australia and N.Z.

A total of 30 FM and AM stations can be preset.

#### How is presetting done?

The two following methods are available.

##### • Automatic memory presetting

Automatic memory presetting allows this unit to automatically search for broadcast stations and then preset them into memory.

With this function, searching proceeds from the frequency currently being displayed and continues through higher frequency, and broadcast stations are preset in the order in which they are located.

With this method, the channels that can be preset into the memory are set as follows for different bands.

##### For United Kingdom

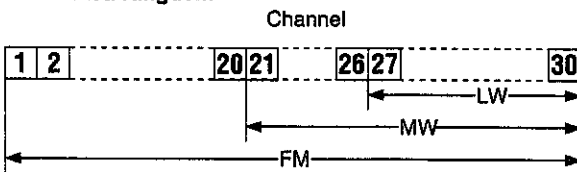

##### For Australia and N.Z.

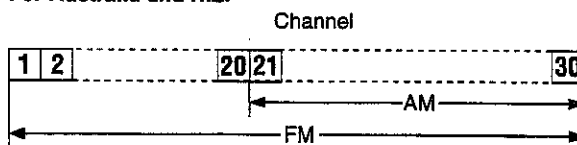

For example, after presetting the FM band, if the MW (or AM) band is preset, the previous presettings in the sections in the above illustration which overlap will be erased and the subsequent settings will be preset. Therefore, the FM band stations will be kept for channels 1-20 and the MW (or AM) band stations will be preset to channels 21-30.

##### • Manual memory presetting

The desired broadcast stations can be preset into the desired channels by the user.

This can also be used as a method for changing selected broadcast stations that were preset in "Automatic memory presetting".

##### Note

If a new broadcast station is preset into a channel, the setting for the broadcast station which was previously entered in that channel will be automatically erased.

## Automatic memory presetting

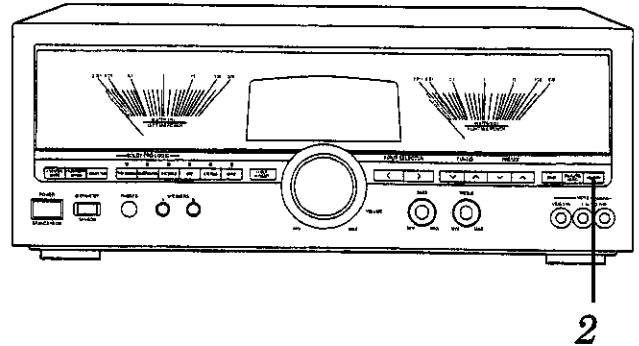

1

Set to the frequency from which you want to start automatic memory presetting.

(See page 21.)

2

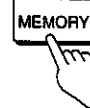

Press MEMORY until the frequency begins to change. (Automatic memory presetting will start.)

During automatic memory presetting, the memory indicator will flash while the frequency scrolls.

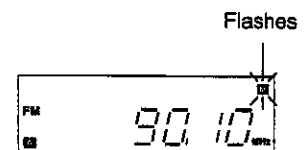

To stop, press MEMORY once again.

### When a broadcast station is preset

The memory indicator and the preset channel number will be displayed for approximately 1 second.

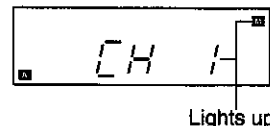

### When presetting is completed

The last broadcast station to be preset will be displayed.

##### Note

Frequencies may not be preset correctly in cases where the broadcast waves are too strong or too weak. In such cases, carry out presetting manually.

## Manual memory presetting

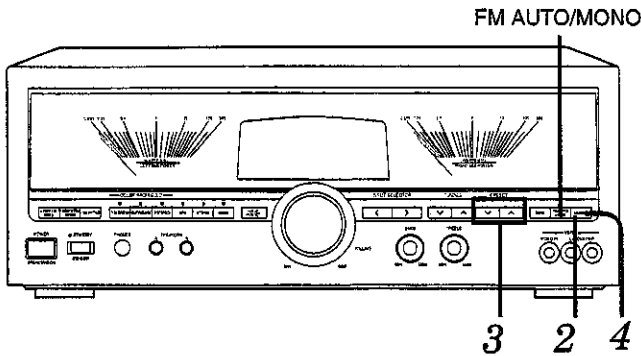

### 1 Set to the desired broadcast.

(See page 21.)

If interference or static is keeping you from enjoying an FM broadcast, press FM AUTO/MONO and change to monaural. You can preset the memory in monaural just as in stereo.

### 2

MEMORY

Press MEMORY. (Touch only.)

Lights up

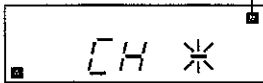

To cancel the memory function, press MEMORY again.

### 3

PRESET

Press  $\nabla$  or  $\blacktriangle$  to select the desired channel.

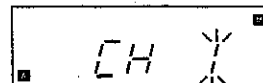

Flashes

Holding the buttons down lets you scroll through channels faster.

### 4

MEMORY

Press MEMORY.

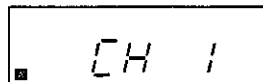

The channel will blink on the display.



## To listen to preset broadcast stations

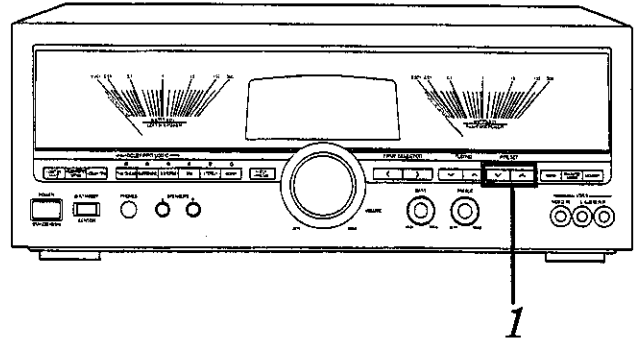

### 1

PRESET

Press  $\nabla$  or  $\blacktriangle$  to select the desired channel.

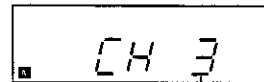

Preset channel

Holding the buttons down lets you scroll through channels faster.

After the preset channel is displayed, the frequency of the selected channel is displayed.

### For tuning by remote control

First press the TUNER button on the remote control and specify the channel you want with the numeric keys. (See page 30.)

#### To designate channels 1-9

Press the appropriate (1-9) preset-tuning button.

#### To designate channels 10-30

(Example: Channel 12)

$\geq 10 \xrightarrow{\text{within 10 sec.}} 1 \xrightarrow{\text{within 10 sec.}} 2$

### To confirm the channel number of the broadcast station being received

Press TUNER on the remote control.

(The channel number will be displayed for about one second.)

#### Note

The channel number is not displayed if you change the reception frequency or FM mode setting.

### For your reference

Even if the power is switched to standby or the power cord is disconnected from the household AC outlet, the memory will retain its contents for approximately one month.

### If frequency presettings are accidentally erased

Make the presettings once again.

The power cord should remain connected for one hour or more for the memory back-up to be effective.

### To continue presetting

Repeat steps 1 through 4.

# Making a recording

## Note

- Tone adjustments and playback mode effects cannot be recorded.
- Do not change the input source while recording. This will change what is recorded on tape.

## Recording on the VCR

You can record only on VCR 1.  
 Before recording, prepare the VCR (VCR1) for recording (recording level adjustment, input selector setting, etc.).  
 See the VCR's operating instructions for details.

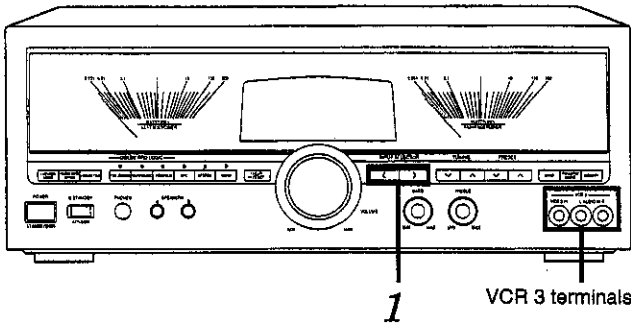

**1** INPUT SELECTOR Press INPUT SELECTOR (< or >) to select the desired source to be recorded.

Each time you press this button, audio and video sources will be switched as follows.

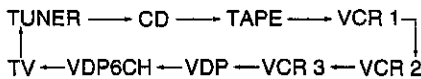

**To record TV pictures and sound**  
 Be sure to set the TV/VIDEO mode on the TV to "TV".

## Note

When you select VDP6CH, only sound from the front left and right speakers is recorded.  
 To record all 6 channels, switch to a 2 channel output mode. For details, see the instruction manual that came with the connected equipment.

**2** **Begin recording on the VCR 1.**  
 Follow your VCR's operating instructions.

**3** **Begin the desired source to be recorded.**  
 Follow your equipment's operating instructions.

## For your reference

There are VCR 3 terminals at the front of this unit.  
 It is easier to carry out dubbing from a camcorder if it is connected to the front terminals.

## Recording on the tape deck

Before recording, prepare the tape deck for recording (recording level adjustment, etc.).  
 See the tape deck's operating instructions for details.

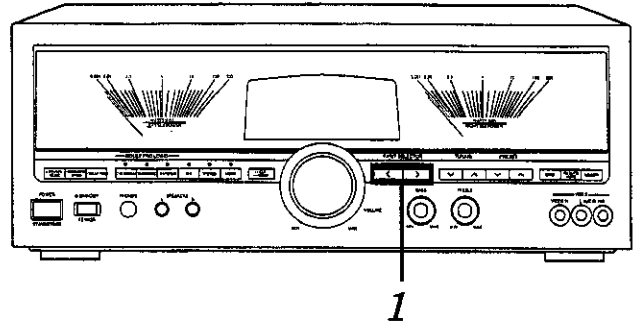

**1** INPUT SELECTOR Press INPUT SELECTOR (< or >) to select the desired source to be recorded.

Each time you press this button, audio and video sources will be switched as follows.

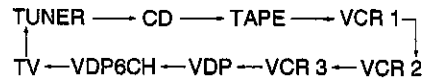

**To record TV sound**  
 Be sure to set the TV/VIDEO mode on the TV to "TV".

## Note

When you select VDP6CH, only sound from the front left and right speakers is recorded.  
 To record all 6 channels, switch to a 2 channel output mode. For details, see the instruction manual that came with the connected equipment.

**2** **Begin recording.**  
 Follow your tape deck's operating instructions.

**3** **Begin the desired source to be recorded.**  
 Follow your equipment's operating instructions.



# On-screen display function

The On-Screen Display function can provide a wide range of information on a TV screen, thus making operation easier. For example, by pressing the button(s), the state of each setting will display. If there is no sound and you do not understand why, press the HELP button to display an outline drawing of the unit and applicable operating procedures on the TV.

**Note**

The On-Screen Displays are produced as PAL system video signals. With TVs of other video systems, the displays may not be clear.

**Before trying to display anything**

- Check your receiver is connected from "TV MONITOR OUT" on the rear panel to "VIDEO INPUT" on the TV rear panel.
- Turn on the power supply for the TV and set the TV to the video mode.

**Note**

When using a TV with an S-VIDEO terminal, see page 8.

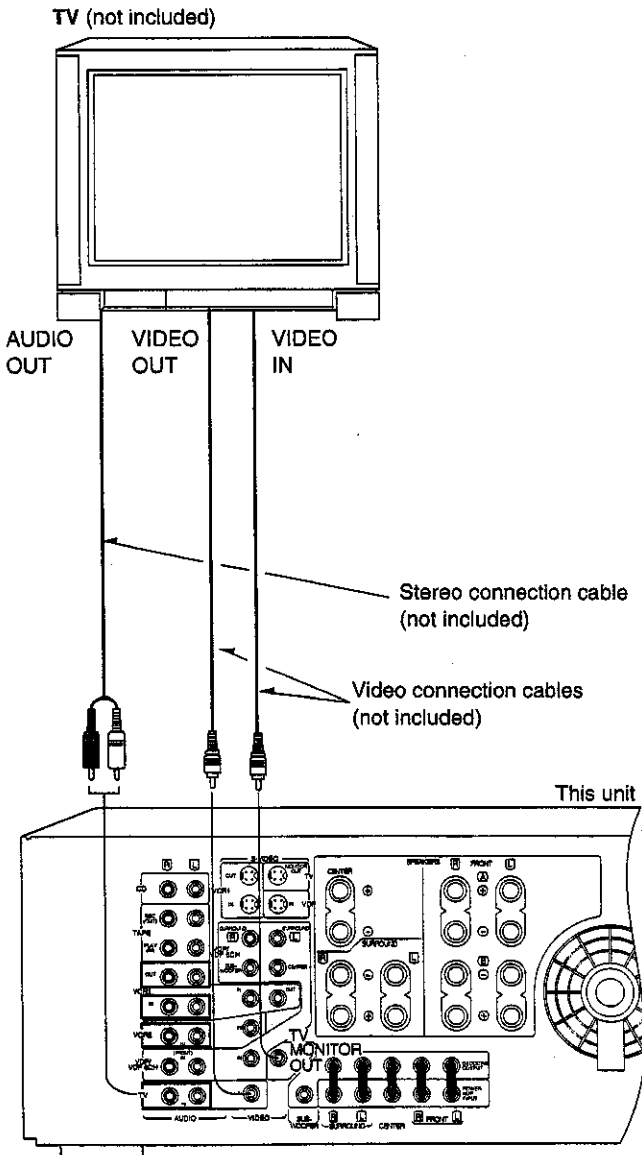

## Types of displays for TV screens

There are 5 different types of displays that appear on the TV.

### 1 Simple stereo operation displays

These displays mirror operation as you press buttons.

They are directly superimposed over the picture while you watch and operate your receiver, except, of course, if no picture is projected, then a blue background is produced.

Messages are displayed only when you operate the controls show below.

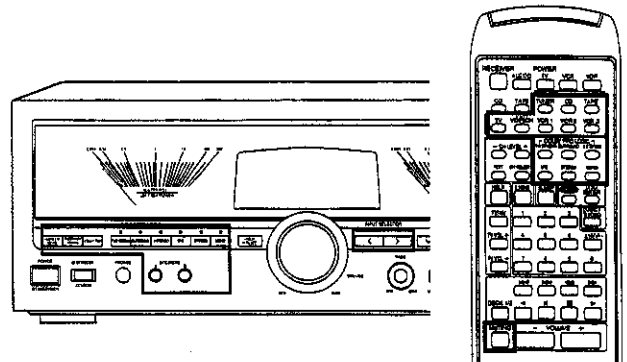

In this example, the VCR1 has been selected as the input source.

**Note**

While muting is ON, the message "MUTING ON NOW" is displayed. The box and wording are alternately highlighted to call your attention to the fact that the sound has been muted.

**Auto HELP**

The following messages run across the TV screen when you turn ON the power to the receiver, if your receiver is set as described below.

Receiver setting	Messages
Both speakers A and B are OFF	<b>SPEAKERS OFF NOW</b>

**To turn OSDs (On-screen display) ON/OFF**

Hold down the FM AUTO/MONO button on the main unit for a moment. Every time you hold the button down, the function switches between ON and OFF. On the TV, OSD ON and OSD OFF will be displayed as you make your selection. REMEMBER the FM AUTO/MONO button turns ON/OFF the simple stereo operation displays only and has nothing to do with other displays mentioned in this section.

## Types of displays for TV screens

### 2 Basic control status display

This display lets you get a quick view of your present settings.

Though basic, it puts the status of the settings below on a single screen, in front of a blue background, for your review.

To view, press the HELP button. (Touch only.)

Pressing again turns off the display.

- Currently set input source
- Selected speaker systems
- Dolby Pro Logic/SFC/STEREO/MONO/VDP6CH modes

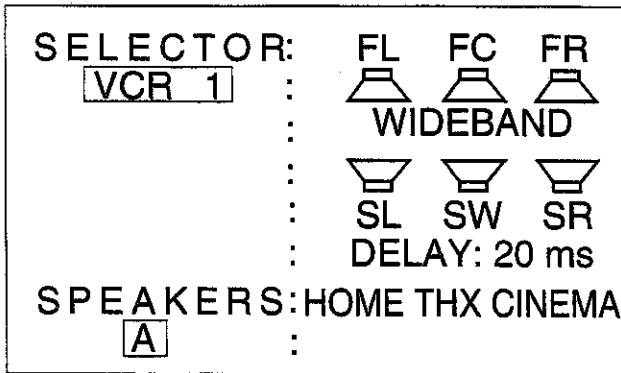
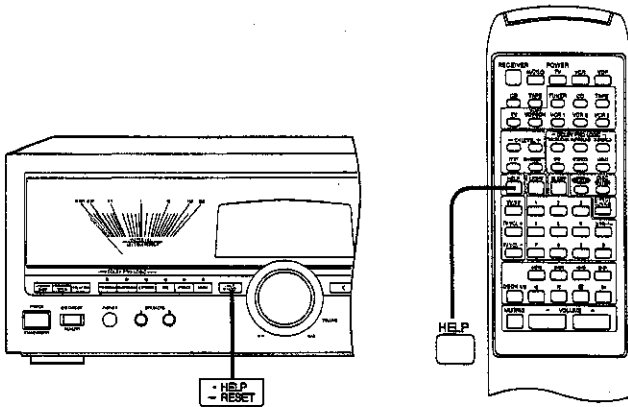

In this example, VCR1 has been selected as the input source, speaker A is selected, delay time is 20 ms, the DOLBY PRO LOGIC THX CINEMA mode is ON and the WIDEBAND is selected as the center mode.

When you're having trouble operating your receiver, the help display appears when you press the HELP button (Touch only). (See "Help displays" at the right.)

### 3 Help displays

These displays promptly advise you on what to do when you're having trouble operating your receiver, for example, when no sound comes out.

To get help, press the HELP button (Touch only). The button you need to operate will start flashing on the illustration and information you'll want to know will be highlighted on a green background.

#### Example 1

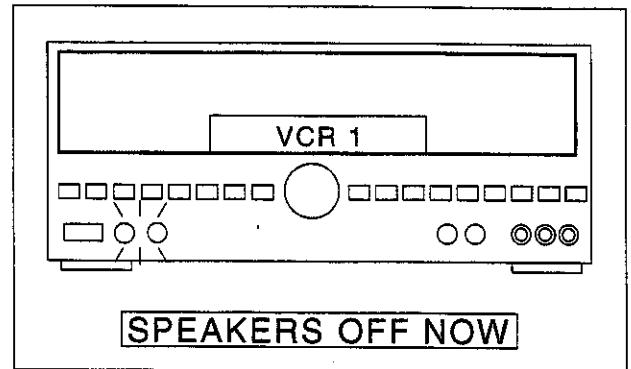

In this example, sound is not coming out because the speaker select buttons are both OFF.

#### Note

In the above example, after the message shown is displayed, the message "SELECT SPEAKER A OR B" runs across the screen from right to left, instructing you how to gain back the sound.

#### Example 2

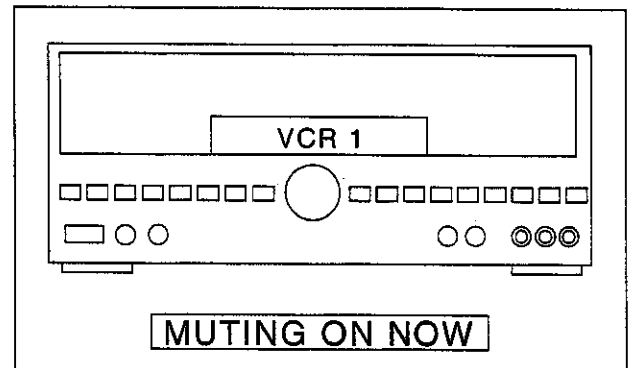

In this example, sound is not coming out because muting is ON.

#### Note

In the above example, after the message is displayed, the message "PRESS THE MUTING BUTTON ON REMOTE CONTROLLER" runs across the screen from right to left, instructing you how to gain back the sound.

If you press the wrong button or do something the receiver won't let you, the message "ERROR" will be shown on the receiver's display. At the same time, the message "PLEASE PRESS THE HELP BUTTON" will run across the TV screen.

In such a case, press the HELP button (Touch only). A worded message explaining how to fix the trouble will run across the display while the button you need to press will flash on the illustration also.

■ **When you wrongly input the frequency in direct tuning**

The message "ENTER CORRECT FREQUENCY" will run across the screen.

■ **When you try turning ON both speaker A and B while Dolby Pro Logic (THX CINEMA, SURROUND, 3 STEREO), SFC or MONO is ON**

The message "PRESS THE STEREO BUTTON OR SELECT ONLY SPEAKER A OR B" will run across the screen.

■ **When you try turning ON both speaker A and B while VDP6CH mode is ON**

The message "SELECT ONLY SPEAKER A OR B" will run across the screen.

■ **When you try turning ON either Dolby Pro Logic (THX CINEMA, SURROUND, 3 STEREO), SFC or MONO while both speaker A and B are ON**

The message "TURN OFF SPEAKER A OR B" will run across the screen.

#### 4 Output test display

This display is handy when adjusting speaker output level if you're using Dolby Pro Logic (THX CINEMA, SURROUND, 3 STEREO) and VDP6CH.

As each speaker emits the test signal, that speaker's icon is highlighted on the TV. The display follows the sequence the speakers do, unless of course, you select a particular speaker, then it returns to that speaker's icon.

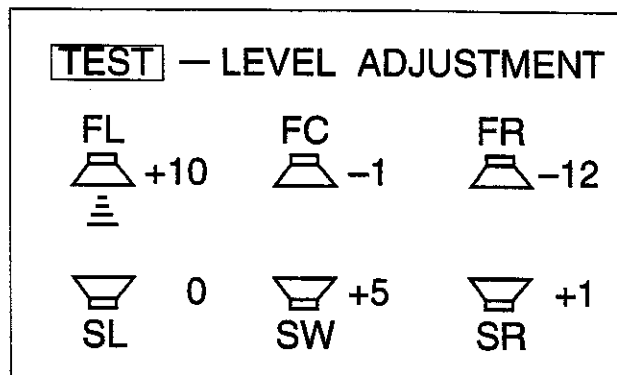

In this example, the THX CINEMA mode has been selected and the test signal is being emitted by the front left speaker.

**Note**

While you adjust output level, the test signal is produced only from the speaker you are now adjusting. At the same time, the display stops on that speaker's icon and a volume bar indicating output in dB appears. The level then changes as you adjust output.

#### 5 Overload display

When this message is displayed, you have overloaded your system.

**Probable cause(s)**

The protection circuitry has functioned because the positive and negative speaker connection wires are "shorted". Speaker systems with an impedance less than the indicated rated impedance of this unit are used or under severe use, such as loud volume, excessive power and in an excessively hot environment.

The "OVERLOAD" message will appear on a red background. When this display comes up, switch off the power, and after determining and correcting the cause, switch ON the power once again.

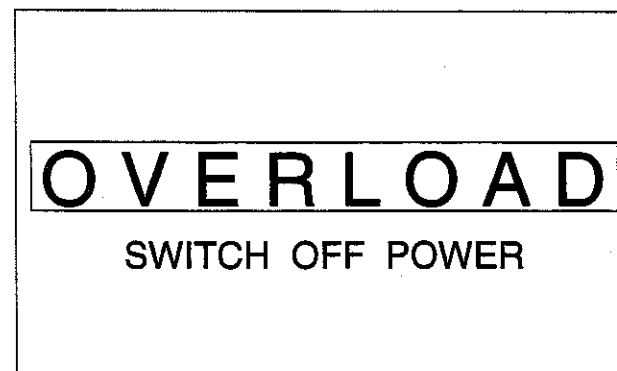

# Sleep timer function

The sleep timer is an excellent little feature that lets you fall asleep with the radio. You can set the timer to turn off after 30, 60 or 90 minutes.

**Note**

The sleep timer turns off the receiver, but it does not turn off any externally connected components.

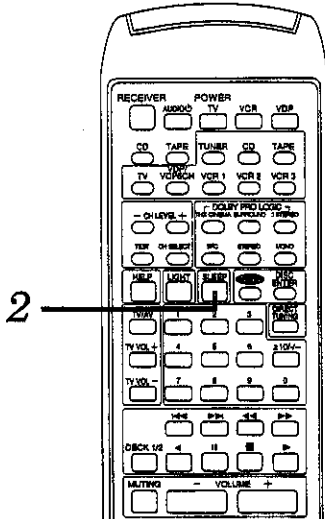

**1**

**Set to the desired broadcast.**  
(See pages 21-23.)

**2**

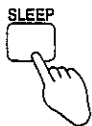

(While listening to a source)  
**Press SLEEP and set how long (minutes) you want the source to continue playing.** Each time the button is pressed, the indicator will change in the order:

30 → 60 → 90 → OFF

The display returns to the way it was before in about 5 seconds, and the "SLEEP" indicator will appear on the display.

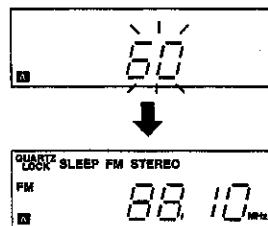

**To cancel the sleep timer**

Press SLEEP until "OFF" is displayed. The "SLEEP" indicator will go out.

**To check how much time is left (while the timer is running)**

Press SLEEP once.

**Note**

Do not press SLEEP again before the remaining time indication goes out. If you do so, the timer will return to the setting mode.

**To change the setting time (while the timer is running)**

1. Press SLEEP.
2. Press SLEEP again while the remaining time is displayed and then reset the timer (30, 60 or 90 minutes).

# Remote control operation

This remote control transmitter can be used to operate other units manufactured by this company in addition to this receiver, including TVs and VCRs manufactured since 1985, laser disc players, CD players (or CD changers) and cassette decks which are equipped with a remote control sensor.

For detailed information concerning operation steps, etc., please refer to the appropriate page for each unit and the respective operating instructions.

## To operate the receiver

Facing toward the receiver

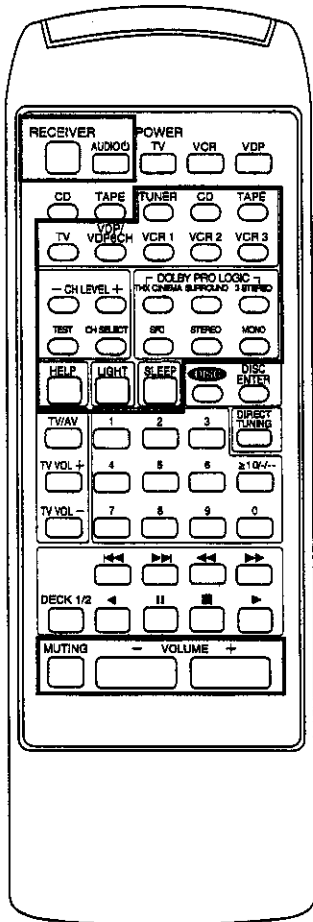

### Basic operations

<b>To turn the receiver ON/OFF</b>	RECEIVER <input type="checkbox"/>
<b>To select an input source</b>	TUNER CD TAPE <input type="checkbox"/> <input type="checkbox"/> <input type="checkbox"/> TV VDP/VDP6CH VCR 1 VCR 2 VCR 3 <input type="checkbox"/> <input type="checkbox"/> <input type="checkbox"/> <input type="checkbox"/> <input type="checkbox"/> Each time you press the VDP/VDP6CH button, "VDP" and "VDP6CH" will be switched alternately.
<b>To select the desired playback mode</b>	THX CINEMA SURROUND 3 STEREO SFC STEREO MONO <input type="checkbox"/> <input type="checkbox"/> <input type="checkbox"/> <input type="checkbox"/> <input type="checkbox"/> <input type="checkbox"/> Each time you press the SFC button, you can change the SFC mode.
<b>To output a test signal</b>	TEST <input type="checkbox"/> Press once more to stop the test signal.
<b>To adjust the output level of each speaker</b>	CH SELECT → -CH LEVEL + or TEST → -CH LEVEL + (See pages 14 and 15.)
<b>To select the sleep timer</b>	SLEEP <input type="checkbox"/> Changes as follows each time the button is pressed. 30 → 60 → 90 → OFF
<b>To display basic control status and procedures for remedying trouble</b>	HELP <input type="checkbox"/> (See pages 20 and 26.)
<b>To mute the sound level</b>	MUTING <input type="checkbox"/> Press once more to return to the original volume.
<b>To adjust the volume level</b>	- VOLUME + <input type="checkbox"/> <input type="checkbox"/>
<b>To turn the power meter light OFF/ON</b>	LIGHT <input type="checkbox"/>
<b>To turn the audio system OFF</b>	AUDIO <input type="checkbox"/> (This may not be possible with some models.)

# Remote control operation

## To operate the receiver (continued)

<p>Facing toward the receiver</p> <p>RECEIVER POWER AUDIO TV VCR VDP          CD TAPE TUNER CD TAPE          TV VCR/CH VCR 1 VCR 2 VCR 3          - CH LEVEL + DOLBY PRO LOGIC -          TEST CH SELECT SFC STEREO MONO          HELP LIGHT SLEEP DISC ENTER          TV/AV 1 2 3 DIRECT TUNING          TV VOL + 4 5 6 210%          TV VOL - 7 8 9 0          DECK 1/2          MUTING - VOLUME +</p>	<p><b>To listen to radio broadcasts</b></p>	
	<p><b>To switch the remote control to tuner operation mode</b></p> <p>TUNER </p> <p>Be sure to press this button before operating the receiver.</p>	
	<p><b>To select the desired channel (Preset tuning)</b></p> <p>(Example: Channel 9)</p> <p>(Example: Channel 12)</p> <p>within 10 seconds</p>	
<p><b>To select radio stations by frequency (Direct tuning)</b></p> <p>First select the BAND button on the receiver.</p> <p>(Example: 107.90MHz)</p> <p>within 10 seconds</p>		

## To operate a TV

<p>Facing toward the TV</p> <p>RECEIVER POWER AUDIO TV VCR VDP          CD TAPE TUNER CD TAPE          TV VCR/CH VCR 1 VCR 2 VCR 3          - CH LEVEL + DOLBY PRO LOGIC -          TEST CH SELECT SFC STEREO MONO          HELP LIGHT SLEEP DISC ENTER          TV/AV 1 2 3 DIRECT TUNING          TV VOL + 4 5 6 210%          TV VOL - 7 8 9 0          DECK 1/2          MUTING - VOLUME +</p>	<p><b>To turn the TV ON/OFF</b></p> <p>POWER TV </p>	
	<p><b>To switch the remote control to TV operation mode</b></p> <p>TV </p> <p>Be sure to press this button before operating the TV.</p>	
	<p><b>To select the TV/VIDEO mode</b></p> <p>TV/AV </p> <p>The TV screen will change each time the button is pressed.</p>	
	<p><b>To select the desired channel</b></p> <p>(Example: Channel 9)</p> <p>(Example: Channel 12)</p> <p>within 10 seconds</p>	
<p><b>To adjust the volume level</b></p> <p>TV VOL + </p> <p>TV VOL - </p>		

# To operate a VCR

Facing toward the VCR

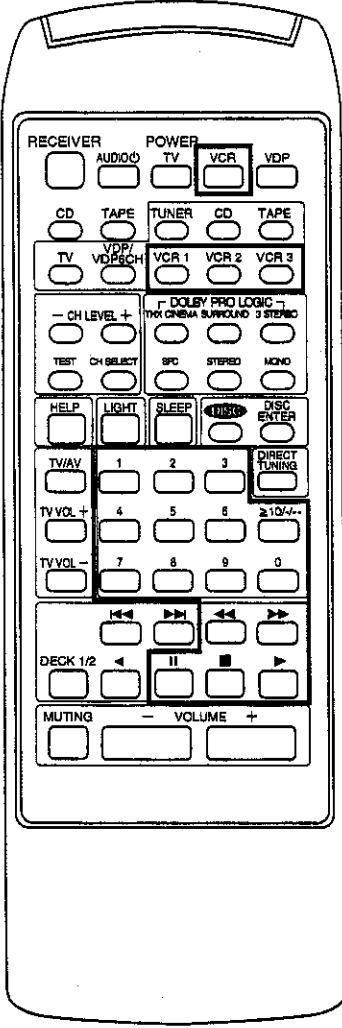

<p>To turn the VCR ON/OFF</p>	<p>VCR </p>
<p>To switch the remote control to VCR operation mode</p>	<p>VCR 1 VCR 2 VCR 3  Be sure to press one of these buttons before operating the VCR.</p>
<p>To start play</p>	<p></p>
<p>To select the desired channel</p>	<p> (Example: Channel 9)  (Example: Channel 12) </p>
<p>To fast-forward or rewind the tape</p>	<p>In the stop mode </p>
<p>To stop playback temporarily</p>	<p> Press once again to resume play.</p>
<p>To stop play</p>	<p></p>

# Remote control operation

## To operate laser disc players

Facing toward the laser disc player

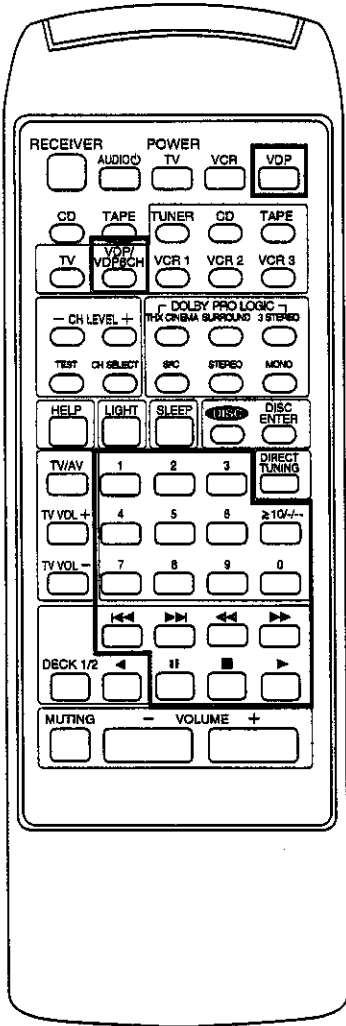

<p>To turn the laser disc player ON/OFF</p>	<p>VDP </p>
<p>To switch the remote control to laser disc player operation mode</p>	<p>VDP/VDP6CH </p> <p>Each time you press this button, the input source ("VDP" or "VDP6CH") will be switched alternately. To watch a laser disc, be sure to set it to "VDP".</p>
<p>To start play</p>	<p></p>
<p>To search for the desired position</p>	<p>In the stop mode</p> <p> </p> <p>(Backward) (Forward)</p>
<p>To skip a chapter</p>	<p>In the play or pause mode</p> <p> </p> <p>(Backward) (Forward)</p>
<p>To select the desired chapter</p>	<p> (Example: Chapter 1)</p> <p> (Example: Chapter 21)</p> <p> </p>
<p>To stop play temporarily</p>	<p> Press  to resume play.</p>
<p>To stop play</p>	<p></p>



## To operate a CD player (or CD changer)

For detailed information concerning CD player (or CD changer) operation, please read the operating instructions for each unit carefully.

<p>Facing toward the CD player (or CD changer)</p>	<p><b>To turn the CD player (or CD changer) ON/OFF</b></p> (A)
	<p><b>To switch the remote control to CD player (or CD changer) operation mode</b></p> (B) Be sure to press this button before operating the CD player or CD changer.
	<p><b>To start play</b></p>
	<p><b>For 5 CD changer</b></p> <p>Select a disc number.</p>
	<p><b>For MEGA CD changer ※</b></p> <p>Select the disc number. If you select "0", the changer will switch to the single disc play mode. (When selecting discs, the ≥10/-- button does not respond to touch.)</p> <p><b>For your reference</b></p> <p>If you press this button instead of the ► button shown in the above procedure, the CD changer will stop and display the disc number. To start the disc, press ►.</p>
	<p><b>[CD changer only]</b> <b>To start play from the desired disc</b></p>
	<p><b>To start play from a specific track</b></p> <p>Select the track number. (Example: Track 9)</p> <p>(Example: Track 12)</p>
	<p><b>To skip a track</b></p> (Backward)       (Forward)
<p><b>To search for a specific point on a disc</b></p> <p>In the play mode or pause mode</p> (Backward)       (Forward)	
<p><b>To stop play temporarily</b></p> Press ► to resume play.	
<p><b>To stop play</b></p>	

※ By "MEGA CD changer", it is meant any Technics CD changer that takes more than 50 discs.

# Remote control operation

## To operate a cassette deck

For detailed information concerning cassette deck operation, please read the operating instructions for the unit carefully.

<p>Facing toward the cassette deck</p>	<p><b>To turn the cassette deck ON/OFF</b></p>	<p>TAPE  <b>ⓐ</b></p>
	<p><b>To switch the remote control to cassette deck operation mode</b></p>	<p>TAPE  <b>ⓑ</b> Be sure to press this button before operating the cassette deck.</p>
	<p>Only when using a double cassette deck <b>To select the tape deck (DECK 1/DECK 2)</b></p>	<p>DECK 1/2  The remote control indicator of the cassette deck will change each time the button is pressed.</p>
	<p><b>To start playback</b></p>	<p>  (Reverse) (Forward)</p>
	<p><b>To fast-forward or rewind the tape</b></p>	<p>While the tape is stopped   With TPS-equipped cassette decks, while the tape is playing, you can move to the beginning of a track by pressing these buttons.</p>
	<p><b>To stop playback temporarily</b></p>	<p> Press once again to resume playback.</p>
<p><b>To stop playback</b></p>	<p></p>	

# Troubleshooting guide

Before requesting service for this unit, check the chart below for a possible cause of the problem you are experiencing. Some simple checks or a minor adjustment on your part may eliminate the problem and restore proper operation.

If you are in doubt about some of the check points, or if the reme-

dies indicated in the chart do not solve the problem, refer to the directory of authorized service centers (enclosed with this unit) to locate a convenient service center, or consult your Technics dealer for instructions.

Problem	Probable cause(s)	Suggested remedy
<b>While listening to FM broadcasts</b>		
An unusual hissing noise is heard when listening to the broadcast in stereo, but not heard when listening monaurally.	A slight noise may be heard because the method used for modulation of FM stereo broadcasts is different than that used for monaural broadcasts.	<ul style="list-style-type: none"> <li>• Try reducing the treble sound by using the treble control.</li> <li>• Try changing the location, height and/or direction of the antenna.</li> <li>• If an indoor antenna is being used, change to an outdoor antenna.</li> <li>• Try using an antenna with more elements.</li> </ul>
Noise is excessive in both stereo and monaural broadcasts.	Poor location and/or direction of the antenna. Transmitting station is too far away.	
The FM stereo indicator or the quartz lock indicator flickers, without completely illuminating.	Poor location and/or direction of the antenna. Transmitting station is too far away.	<ul style="list-style-type: none"> <li>• Try changing the location, height and/or direction of the antenna.</li> <li>• If an indoor antenna is being used, change to an outdoor antenna.</li> <li>• Try using an antenna with more elements.</li> </ul>
Excessive distortion in the sound of stereo broadcasts.	Nearby building or mountain.	
<b>While listening to MW/LW (For Australia and N.Z.: AM) broadcasts</b>		
An unusual "beat" sound is heard.	Unit is being used at the same time as the television set. Interference from adjacent broadcast signal.	<ul style="list-style-type: none"> <li>• Turn off the television set, or use this unit farther away from it.</li> <li>• Try reducing the treble sound by using the treble control.</li> </ul>
A low-pitched "hum" sound is heard when the broadcast is tuned.	The AM loop antenna connection wires are too close to the power cord.	<ul style="list-style-type: none"> <li>• Place the antenna connection wires and the power cord farther apart.</li> </ul>
A strange hissing noise is produced continuously or intermittently.	Caused by the "discharge phenomenon" and the "oscillation phenomenon" of electric appliances (such as fluorescent lights, TV, small series-type motors, rectification equipment, etc.).	<ul style="list-style-type: none"> <li>• Try placing this unit farther away from such equipment.</li> </ul>
An MW broadcast station cannot be picked up clearly.	Frequency steps is set to 10 kHz.	<ul style="list-style-type: none"> <li>• Hold down BAND for about 3 seconds. This will change frequency step to 9 kHz.</li> </ul>
<b>Problems noted at all times</b>		
Power will not switch ON.	The power cord plug is not completely inserted.	<ul style="list-style-type: none"> <li>• Confirm that the power cord plug is connected completely.</li> </ul>
No sound is heard.	Both A and B speakers are turned OFF.	<ul style="list-style-type: none"> <li>• Press the HELP button. (The display will scroll through the causes of the problem.) Use this display as a guide to remedy the problem.</li> </ul>
	The muting function is ON.	
	Connections are incomplete or incorrect to the speaker systems, etc.	<ul style="list-style-type: none"> <li>• Check to be sure that all connection wires are correctly connected.</li> </ul>
Sound stops during a performance, or no sound is heard when the power is switched ON. (The word "OVERLOAD" appears on the display.)	The incorrect input source has been selected.	<ul style="list-style-type: none"> <li>• Check to be sure that the correct input source is selected.</li> </ul>
	The protection circuitry has functioned because the positive and negative speaker connection wires are "shorted", speaker systems with an impedance less than the indicated rated impedance of this unit are used or under severe use, such as loud volume, excessive power and in an excessively hot environment.	<ul style="list-style-type: none"> <li>• Turn the unit off, and after determining and correcting the cause, turn the unit on once again.</li> <li>• Use a speaker system of the proper impedance rating.</li> </ul>

# Technical specifications (DIN 45 500)

## ■ POWER AMPLIFIER SECTION

### (POWER AMPLIFIER INPUT)

Power output	
DIN 1 kHz (T.H.D. 1%)	2×130 W (6 Ω)
20 Hz–20 kHz continuous power output both channels driven	2×125 W (6 Ω)
Total harmonic distortion	
rated power at 20 Hz–20 kHz	0.05% (6 Ω)
half power at 1 kHz	0.03% (6 Ω)
Power output at the Dolby Pro Logic operation	
DIN 1 kHz (T.H.D. 1%)	
Front	2×120 W (6 Ω)
Center	120 W (6 Ω)
Surround	2×100 W (6 Ω)

### Intermodulation distortion

rated power at 60 Hz: 7 kHz=4:1, SMPTE	
	0.3% (6 Ω)

### Damping factor

25 (6 Ω)

### Load impedance

Front	
A or B	4–16 Ω
A and B	8–16 Ω
Center	4–16 Ω
Surround	4–16 Ω

## ■ PRE AMPLIFIER SECTION

### Frequency response

CD, TAPE, VCR 1, VCR 2, VCR 3, VDP, VDP6CH, TV 20 Hz–20 kHz, ±1 dB

### Input sensitivity and impedance

CD, TAPE, VCR 1, VCR 2, VCR 3, VDP, VDP6CH, TV 300 mV/34 kΩ

### S/N at rated power (6 Ω)

CD, TAPE, VCR 1, VCR 2, VCR 3, VDP, VDP6CH, TV 70 dB

### Tone controls

BASS 50 Hz, +10 to –10 dB  
TREBLE 20 kHz, +10 to –10 dB

## ■ FM TUNER SECTION

Frequency range 87.50–108.00 MHz

### Sensitivity

S/N 30 dB 1.5 μV/75 Ω  
S/N 26 dB 1.3 μV/75 Ω  
S/N 20 dB 1.2 μV/75 Ω

IHF usable sensitivity 1.5 μV/75 Ω (IHF '58)

IHF 46 dB stereo quieting sensitivity

22 μV/75 Ω

### Total harmonic distortion

MONO 0.2%  
STEREO 0.3%

### S/N

MONO 60 dB (75 dB, IHF)  
STEREO 58 dB (71 dB, IHF)

### Frequency response

20 Hz–15 kHz, +1 dB, –2 dB

### Alternate channel selectivity

±400 kHz 65 dB

### Capture ratio

1 dB

### Image rejection at 98 MHz

40 dB

### IF rejection at 98 MHz

70 dB

### Spurious response rejection at 98 MHz

70 dB

### AM suppression

50 dB

### Stereo separation

1 kHz 40 dB

### Carrier leak

19 kHz –30 dB (–35 dB, IHF)  
38 kHz –50 dB (–55 dB, IHF)

Channel balance (250 Hz–6.3 kHz) ±1.5 dB

### Limiting point

1.2 μV

### Bandwidth

IF amplifier 180 kHz

FM demodulator 1000 kHz

### Antenna terminal(s)

75 Ω (unbalanced)

## ■ AM TUNER SECTION

### For United Kingdom

### Frequency range

MW 522–1611 kHz (9 kHz steps)  
530–1620 kHz (10 kHz steps)

LW 144–288 kHz

### Sensitivity

MW 20 μV, 330 μV/m  
LW 45 μV

### Selectivity

MW (at 999 kHz) 55 dB  
LW (at 252 kHz) 55 dB

### Image rejection

MW (at 999 kHz) 40 dB  
LW (at 252 kHz) 40 dB

### IF rejection

MW (at 999 kHz) 55 dB  
LW (at 252 kHz) 55 dB

### For Australia and N.Z.

### Frequency range

522–1611 kHz (9 kHz steps)  
530–1620 kHz (10 kHz steps)

### Sensitivity

20 μV, 330 μV/m

### Selectivity at 999 kHz

55 dB

### Image rejection at 999 kHz

40 dB

### IF rejection at 999 kHz

55 dB

## ■ VIDEO SECTION

### Output voltage at 1 V Input (unbalanced)

1 ±0.1 Vp-p

### Maximum input voltage

1.5 Vp-p

### Input/output impedance

75 Ω (unbalanced)

## ■ GENERAL

Power supply AC 50 Hz, 230–240 V

Power consumption 330 W

Dimensions (W×H×D) 430×170×375 mm

Weight 12.0 kg

### Notes:

- Specifications are subject to change without notice.  
Weight and dimensions are approximate.
- Total harmonic distortion is measured by the digital spectrum analyzer.

Matsushita Electric Industrial Co., Ltd.  
Central P.O. Box 288, Osaka 530-91, Japan

RQT3603-B

H0696J0