

# TANDBERG

## 10X Stereo Operating Instructions



## Contents

	page		
Preparation for use . . . . .	4	Copying tape . . . . .	17
Operating position . . . . .	4	Sound-on-Sound . . . . .	18
Power requirements . . . . .	4	Language learning . . . . .	20
Switching on . . . . .	4	Echo . . . . .	21
Tape . . . . .	4	Mixing . . . . .	22
Choosing the tape speed . . . . .	5	Mixing two stereo programs . . . . .	22
Automatic end-stop . . . . .	5	Mixing four mono programs . . . . .	22
Remote control . . . . .	5	The 10X used as an amplifier . . . . .	23
Manual speed control (pitch control) . . . . .	5	Microphone amplifier . . . . .	23
Fitting the spools . . . . .	6	Mixer unit for microphones and music . . . . .	23
Tracks and channels . . . . .	7	Mixed playback/amplifier mode . . . . .	23
What is a channel? What is a track? . . . . .	7	Locating a program on tape and editing . . . . .	24
4-track tape decks . . . . .	7	Tape counter . . . . .	24
2-track tape decks . . . . .	7	EDIT/CUE during WIND or REWIND . . . . .	24
Playback . . . . .	8	EDIT/CUE for precision editing . . . . .	24
Making a good recording from any source . . . . .	10	Cutting and splicing . . . . .	25
Recording from a receiver or a transcription unit . . . . .	12	Maintenance . . . . .	26
Recording from microphones . . . . .	14	Cleaning . . . . .	26
Basic procedure . . . . .	14	Degaussing . . . . .	26
Placing microphones for a stereo recording . . . . .	15	Useful data . . . . .	27
Microphone polar diagrams . . . . .	15	Operator's trouble shooting guide . . . . .	28
Suggested microphone positions . . . . .	16		

### For your safety

To prevent electrical shock or fire, do not expose electronic products to rain or moisture and do not remove covers (or back). If anything fails leave the repairs to a qualified technician.

Pull out the power plug and antenna plug during thunder-storms and when you are away for a long time (e.g. holidays, etc.).

#### Specially for the United Kingdom:

**IMPORTANT!** The wires in this mains lead are coloured in accordance with the following code:

- Green and yellow: Earth (E)
- Blue: Neutral (N)
- Brown: Live (L)

This mains lead must be connected to a 3-pin mains plug in accordance with the above code. If the plug is not marked E, N, and L inside, or it has only two pins, consult your dealer.





Tandberg tape recorders have enjoyed international acclaim over the years for the highest quality in design and manufacture — and Tandberg intends to keep it that way.

Model 10X is the result of decades of skill and experience built up by Tandbergs Radiofabrikk A/S.

Progress in technology is continuous and tape recorders improve all the time — but we believe the 10X truly represents an exceptional peak in design and performance that puts it straight into the top class.

Cassette tape recorders have become popular because — amongst other reasons — they are easy to operate and many people are happy with their sound quality. At the same time, for the person who uncompromisingly demands only the finest sound quality, there is still no alternative to an open reel tape recorder. This fact is rooted in the different design principles and standards for the two types of machines.

Our intention with the 10X has therefore been to provide the discriminating amateur tape recordist and all those who value faithful sound reproduction with a tape recorder that has a superb specification and a wide range of operating facilities. The record and playback processes in the 10X have been designed to fully exploit all the features and qualities of the best magnetic tapes.

Professional users have also shown great interest in this model and we have taken this as a sign that we have succeeded with all our objectives.

As a result of our strict requirements in the design, production, and quality control of the 10X, it has become an expensive machine. At the same time, through our international marketing organization we have experienced public reaction that obviously values the effort we have put into this outstanding tape recorder.

**NOTE!**

The 10X is an advanced tape deck and it is possible to go from one operating mode to another operating mode simply by touching a mode button (except from WIND or REWIND to RECORD). To avoid accidental erasure of wanted programs **make sure that the REC SELECT buttons are released** whenever the machine is not being used to record.

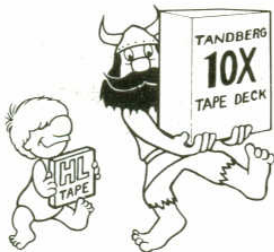

## Preparation for use

### Operating position

The tape deck can be used in a horizontal position or a vertical position or at any intermediate angle. Always make sure that the spool locks are operated to keep the spools secure regardless of the operating position (see "Fitting the spools", page 6).

### Power requirements

Make sure that the tape deck is marked at the back with the correct voltage and frequency for your area as follows:

Standard model: 230 V/50 Hz a.c.

British model: 240 V/50 Hz a.c.

US model: 115 V/60 Hz a.c.

Changing the voltage and/or frequency should be carried out by a competent service technician.

The power consumption is less than 100 watts.

### Switching on

Connect the power cable to a power socket. Depress the switch marked POWER (to the left). The STOP button will light.

**NOTE!** The tape deck will not operate before it is correctly fitted with tape spools nor will it operate if a translucent leader tape is adjacent to the right-hand guide post (see "Automatically end-stop", next page). To wind the tape beyond the translucent section, depress the WIND button and keep it depressed until the translucent section has passed.

### Tape

The tape deck is adjusted for recording on High Output Low Noise (HL) tape. For a given distortion this tape gives 3 to 4 dB higher output level than ordinary low noise tape. HL-tape with matt backing can also be used,

If ordinary low noise tape is used for recording, the deflection on the level meters should be slightly lower than for HL-tape (for instance - 2.5 dB).



*Vertical position*

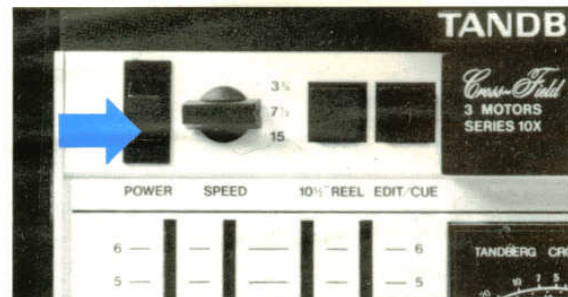

*Switching on*



*Recording on HL-tape*



*Recording on low noise tape*



### Choosing the tape speed

Set the knob SPEED to the required tape speed 15" gives the best sound quality and 3¾" uses the least tape.

### Automatic end-stop

A photoelectric end-stop sensor (located in the right-hand guide post) will stop the machine when the tape runs out or if the tape snaps.

The machine will also stop if a section of transparent tape crosses the guide post. So if you splice in a section of transparent tape at each end of the spool, the machine will automatically go into the stop mode at the end of the spool before the tape runs out. At least 20 inches of transparent tape should be inserted several feet from the end of the spool.

To wind or rewind the tape beyond the transparent section, depress the WIND button and keep it depressed until the transparent section has moved away from the end-stop.

Should the lamp for the end-stop sensor burn out, the recorder will still operate normally, except that it must be stopped manually at the end of the tape.

### Remote control

The 10X can be operated from up to 30 feet away by means of the Tandberg Remote Control 9 (optional accessory). The RECORD, PLAY, REWIND, STOP and WIND button are repeated on the remote control unit. The buttons on the machine will override the remote control unit.

Connect the remote control unit to the socket marked REMOTE CONTROL.

### Manual speed control (pitch control)

The 10X can be modified to take an external pitch control for controlling the tape speed over a range of  $\pm 10\%$  approximately. Ask your dealer for details.

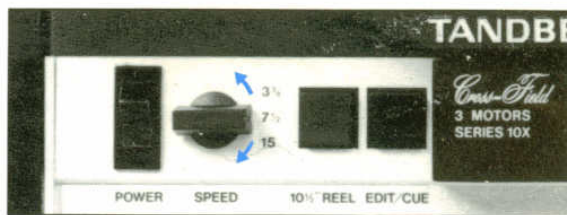

*SPEED knob*

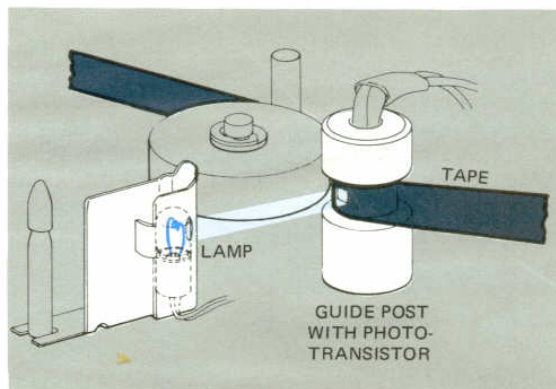

*Photoelectric end-stop*

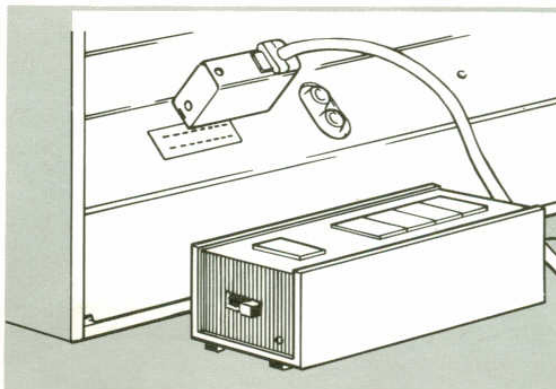

*Connecting the remote control unit*

## Fitting the spools

Spools from 5" up to 10½" in diameter can be used on the 10X.

To fit cine type spools (8 mm holes) follow this procedure with the aid of the diagrams:

1. If the spool is 10½", depress the 10½" REEL button.

2. Grip the threaded part of the spindle on the left turntable with your fingers. Use the other hand to steady yourself against the case of the machine. Pull and twist the plastic part of the spindle until it clicks into a new position and the flanges on it are in line with the flanges on the metal part of the spindle.

3. Fit a full spool of tape to the left turntable with one hand and again pull and twist the spindle with the other hand until it clicks back to the original position with the flanges out of line. Check that the spool cannot be pulled off.

4. Follow the same procedure to put an empty spool on the right turntable.

5. Pull out the end of the tape and pass it round the left tension arm, and over the left guide post,

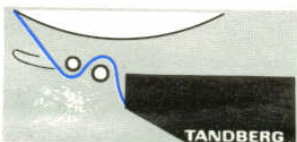

then lay it into the slot between the head covers, then pass it round the right tension arm (inside the small bracket) and finally wrap it round the hub of the empty spool. Take up the slack and trap the end of the tape by rotating the empty spool a few turns anti-clockwise.

6. Hold the WIND button down to wind past the transparent leader tape.

### 10 1/2" spools with large center holes

1. Use the enclosed hubs. Fit one hub onto each spool so that the pips on the hub fit into the slots on the spool.

2. Depress the 10½" REEL button.

3. Insert the tape as explained in step 2-6 above.

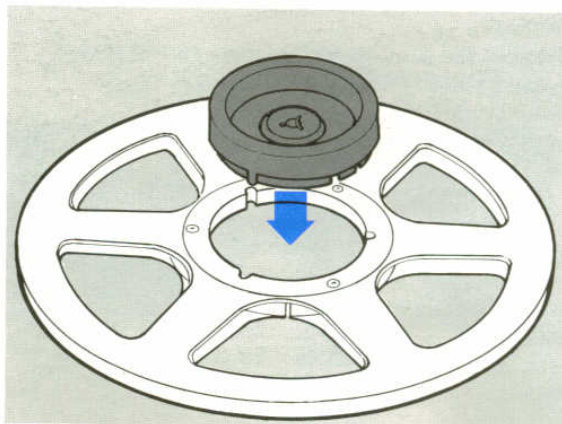
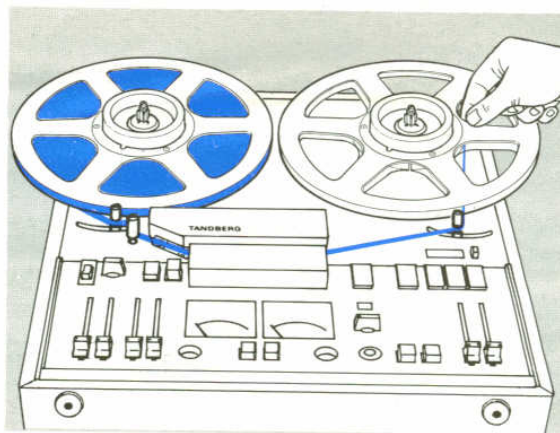
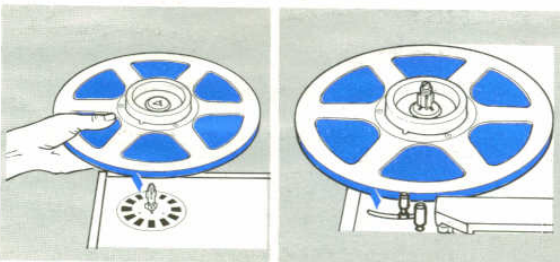
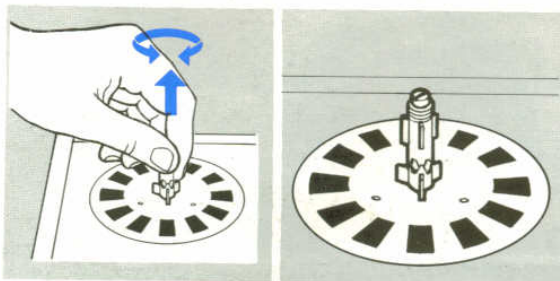
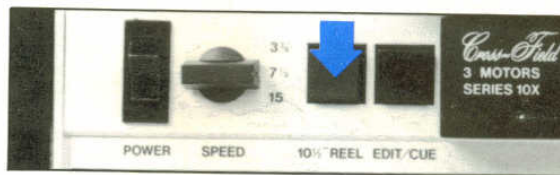



## Tracks and channels

### What is a channel? What is a track?

A *channel* is the path the program follows through the tape deck and amplifier during recording and playback. A mono recording requires only one channel, whereas a stereo recording requires two channels (left and right). Microphones and loudspeakers form parts of this path followed by the program and also receive the labels “left channel” or “right channel”.

A *track* is the strip of the tape along the tape length that is magnetized during recording, and on which the sound is “stored”. There are two types of stereo reel-to-reel tape decks: the 4-track type and the 2-track type. The 4-track and 2-track versions of the 10X are marked 10X-4 and 10X-2 respectively.

### 4-track tape decks

The displacement of the four tracks across the width of the tape is such that when starting from one end of the tape, track 1 (top track) will be recorded when REC SELECT L is depressed and track 3 will be recorded when REC SELECT R is depressed.

When starting from the other end of the tape, recording will take place on track 4 when REC SELECT L is depressed and on track 2 when REC SELECT R is depressed.

This means that you can make one stereo recording or two mono recordings from each end of the tape.

### 2-track tape decks

The displacement of the two tracks across the width of the tape is such that when starting from one end of the tape, track 1 (top track) will be recorded when REC SELECT L is depressed and track 2 will be recorded when REC SELECT R is depressed. A stereo recording made from one end of the tape thus occupies the full width of the tape so that recordings cannot then be made from the other end of the tape. The standard method for making mono recordings is for the two tracks to be recorded in alternate directions (i.e. the tape reel should be turned over and returned to the left-hand turntable after track 1 is full). The REC SELECT buttons should remain unchanged for recording on track 2.

### What are the restrictions?

1. A 4-track recording *cannot* be played back on a 2-track machine if more than 2 tracks have been used.
2. A 2-track recording can be played back on a 4-track machine using the head for tracks 1 and 3. However, the quality will be slightly reduced.
3. If a 2-track recorded tape is used on a 4-track machine for recording another program, the 4-track machine may not completely erase the 2-track recording. Erase the tape using a 2-track machine in the record mode, or use a bulk eraser.
4. Editing a tape that has recordings on more than one track is virtually impossible.

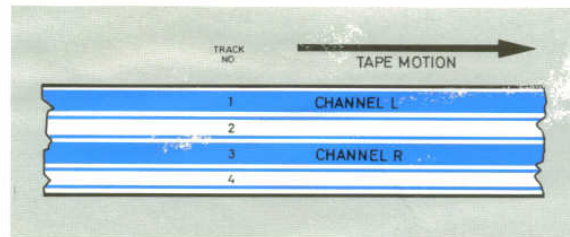

4 track tape deck – recording from one end of the tape

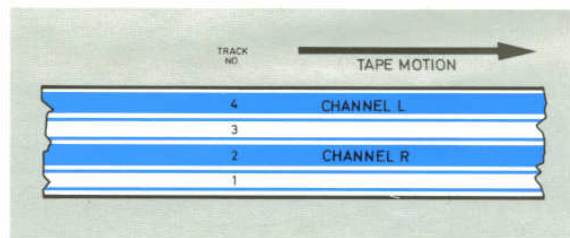

4 track tape deck – recording from the other end of the tape



2 track tape deck

## Playback

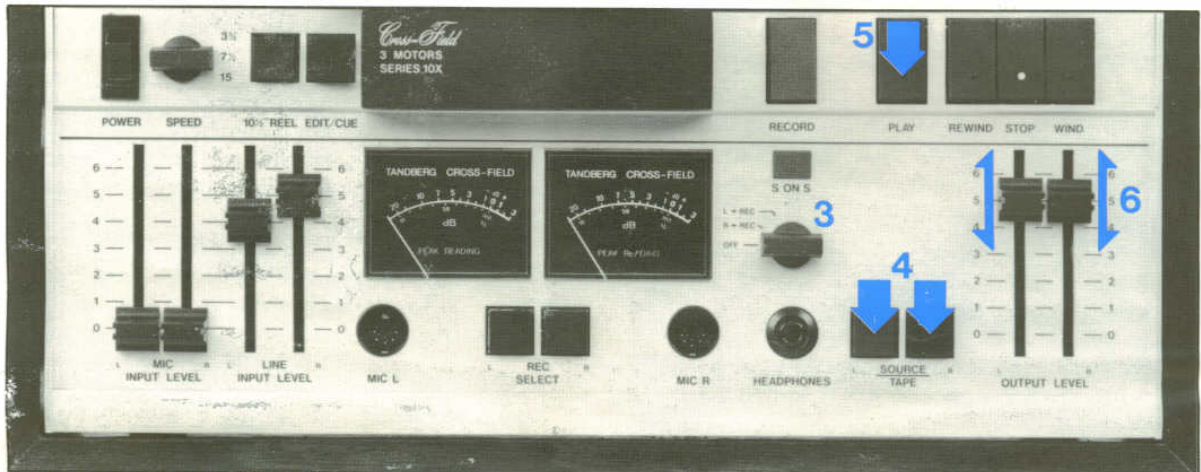

*Stereo playback*

### Playback over loudspeakers

The 10X does not have built-in power amplifiers and loudspeakers; it must therefore be used in conjunction with a stereo receiver/amplifier or stereo amplifier and associated loudspeakers.

1. Connect stereo cables from the sockets LINE OUT L and R on the 10X to the sockets TAPE IN L and R on the receiver or amplifier as shown in the diagrams.

Alternatively, connect a 5-core DIN cable from the socket RADIO on the 10X to the socket TAPE on the receiver or amplifier.

2. Switch on the receiver/amplifier and depress its TAPE button.

3. Set the S ON S knob on the 10X to OFF.

4. Depress both SOURCE/TAPE buttons if it is a stereo program, but only one button if it is a mono program (left or right channel, whichever is required). If you are in doubt about tracks and channels read page 7.

If you depress one SOURCE/TAPE button for a mono program, the program will be fed to both channels on the output of the tape deck when both OUTPUT LEVEL knobs are turned up.

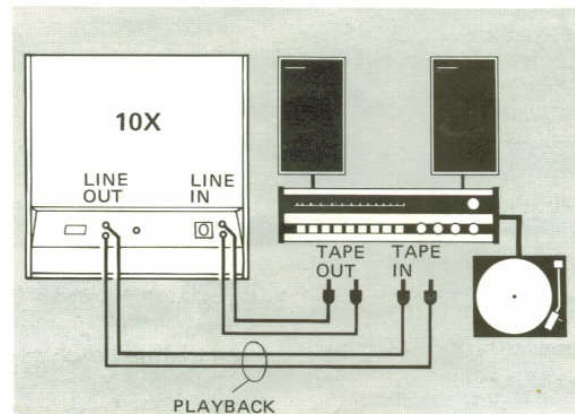

*One way of connecting the 10X for playback*

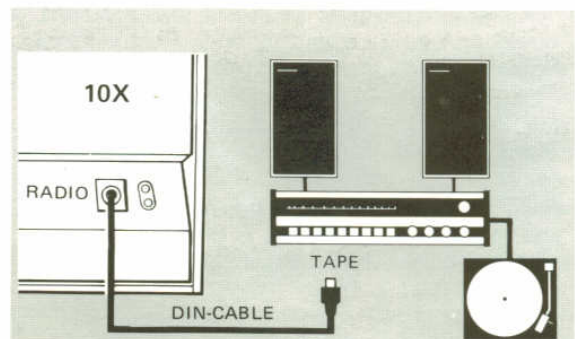

*An alternative way of connecting the 10X for playback*



- Press the PLAY button. Both meters will light to indicate the output level in both channels.

During playback the meters might not deflect up to the red sector (0 dB) even if the program has been recorded at this level. This is normal and is because the higher tones are pre-emphasized during recording. The corresponding de-emphasis during playback conforms to an international standard.

- Adjust the volume of the program by means of the OUTPUT LEVEL slide control to be the same as the level of other programs (from radio or record player). Use the volume control on the receiver/amplifier for further adjustment.

- Stop the playback by pressing the STOP-button.

**NOTE!** When using 10½" spools, depress the 10½" REEL button. When using smaller spools, leave the button out.

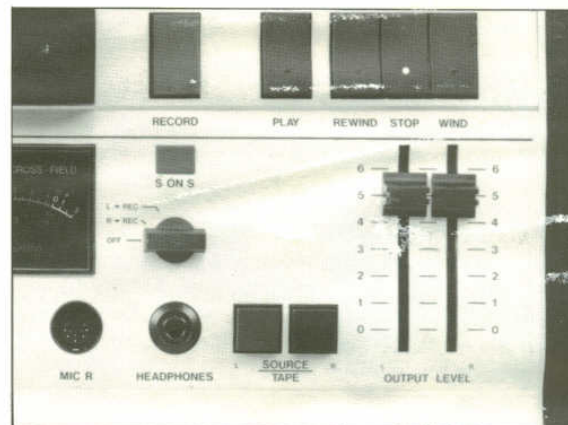

### Headphones

Instead of using loudspeakers you can listen to a stereo or mono program on headphones connected to the jack socket HEADPHONES. Headphones for use with the 10X should be the moving-coil type with a ¼" jack plug. The impedance should be between 8 ohms and 2000 ohms. Junction boxes can be connected provided that the resultant impedance is not less than 8 ohms.



Connecting headphones



## Making a good recording from any source

### 1. Monitor the recording

The sound quality of any recording should be monitored (tested) by means of the SOURCE/TAPE buttons while the recording is being made. In our example we show a vocalist singing into a microphone and an operator monitoring the recording of the vocalist. This is a mono program where only one button is involved. A stereo program will involve both buttons.

**BUTTON OUT:** The operator will hear the vocalist before he is recorded on tape. This is called *source monitoring*.

**BUTTON DEPRESSED:** The operator will hear the vocalist after he has been recorded on tape. This is called *tape monitoring*.

If the recording is being correctly made, the sound quality before and after recording (source and tape tests) will be the same. If there is a different it means you have done something wrong, turned up the input level controls too much or too little or depressed a button that should not have been depressed, for example.

Monitoring can also be carried out from the receiver or amplifier connected to the 10X. The operator's headphones and the TAPE MONITOR button(s) on the receiver or amplifier can be used instead of the SOURCE/TAPE button(s) on the 10X. Use the OUTPUT LEVEL controls on the 10X to obtain the same listening level for both tests.

Many receivers and amplifiers have facilities for monitoring the program over the loudspeakers. It is *not recommended* that these facilities be used when recording from microphones because the sound from the loudspeakers will be picked up by the microphones.

### 2. Read the meters

Watch the level meters carefully during monitoring and make slow, gentle adjustments to the INPUT LEVEL knobs if necessary. The distortion at 0 dB deflection is *maximum 2%*. This means that

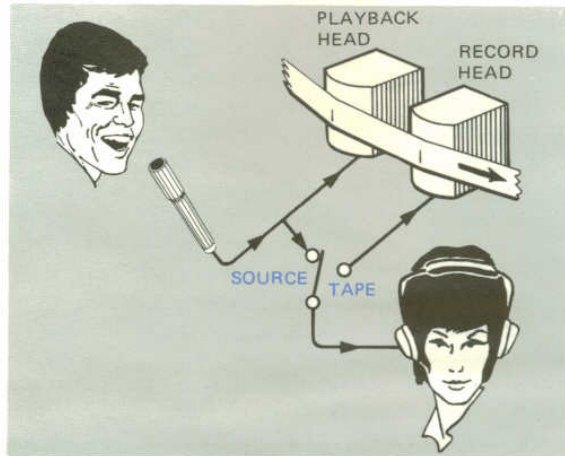

Monitoring the recording

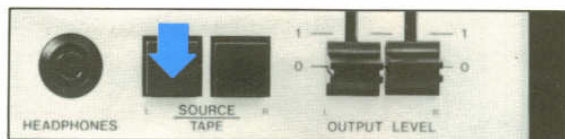

Tape monitoring – mono recording on left channel

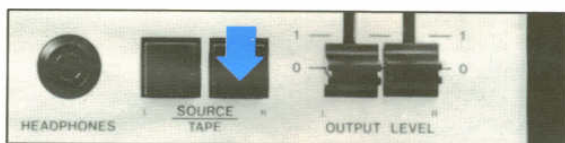

Tape monitoring – mono recording on right channel

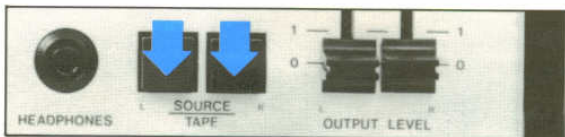

Tape monitoring – stereo recording



Distortion may occur if the pointers pass too far into the red sectors



the meter pointers can pass a short way into the red sector without any audible distortion. Try to anticipate the loudest sounds by making trials before the recording starts.

Some tape requires a higher input level than other tape. Make test recordings on a new tape with different INPUT LEVEL settings to find out how far the pointers can deflect into the red sector before audible distortion occurs.

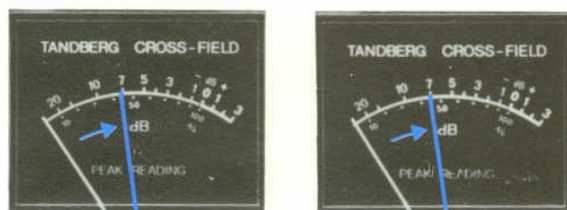

*Poor signal to noise ratio may result if the pointers do not deflect up to the red sectors for the strongest signals*

### 3. Take care with new tape

Use the best quality HL tape. If you are not certain which type to buy, ask a Hi-Fi/radio dealer who stocks several types. He will usually recommend two or three brand names.

You will achieve the best recording results with a new, unused tape.

Always cut away the sticky parts at the ends of a new reel of tape.

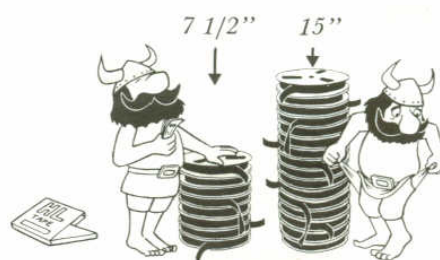

### 4. Choose a suitable tape speed

The 15" setting will give you professional quality recordings, and is well suited for editing purposes, but it uses a lot of tape. However, because of the Crossfield system you can achieve remarkable results at the two lower speeds. So if you are concerned with tape economy, exploit the lower speeds.

### 5. Clean the tape path regularly

Regular tape path cleaning is essential for high quality recordings. Full instructions are given on page 26.



## Recording from a receiver or a transcription unit

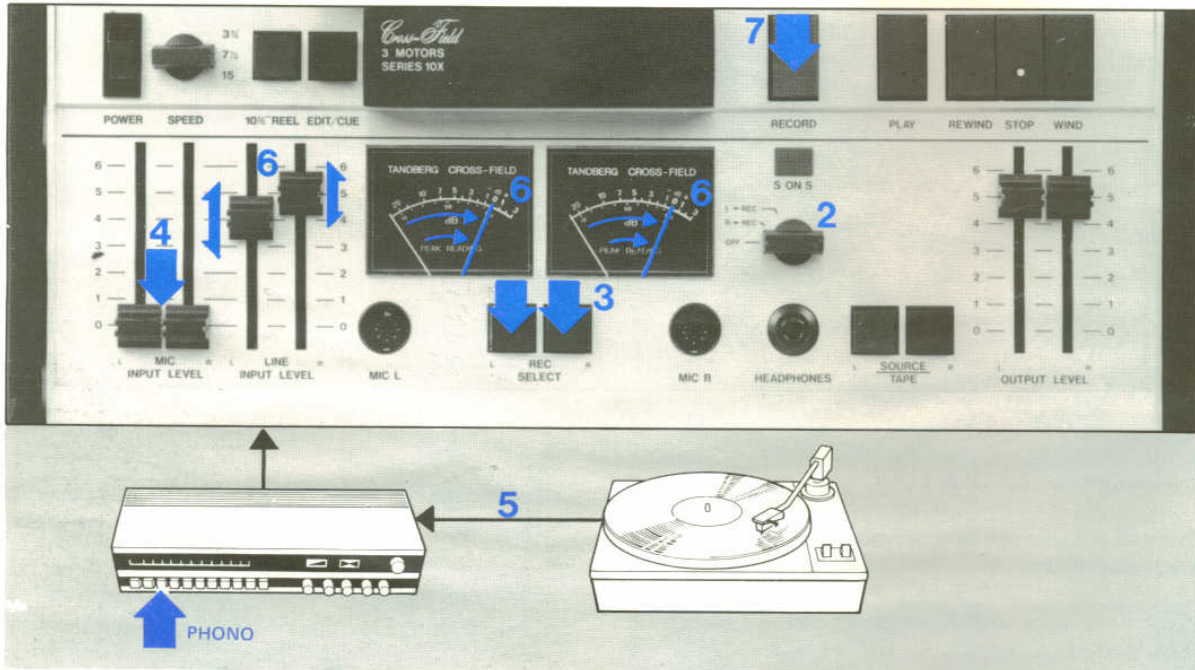

*Stereo recording from transcription unit*

1. Connect phono cables from the sockets LINE IN L and R on the 10X to the sockets TAPE OUT L and R on the receiver as shown in the diagram.

Alternatively, connect a 5-core DIN cable from the socket RADIO on the 10X to the socket TAPE on the receiver.

2. Set the S ON S knob to OFF.

3. Depress both the REC SELECT buttons for a stereo recording, but only one button for a mono recording. When only one REC SELECT button is depressed both channels from the receiver or transcription unit will be connected to one track on the 10X giving "full mono" from a stereo program.

4. Set the MIC INPUT LEVEL knobs to zero.

5. If it is a radio program you are recording, depress the AM or FM button on the receiver and tune in to the station. If it is a record you are recording, depress the PHONO button and prepare the record.

6. If it is a radio program, try to anticipate the setting(s) of the LINE INPUT LEVEL knob(s) by looking at the meter(s) while a similar piece of music is being played before your recording

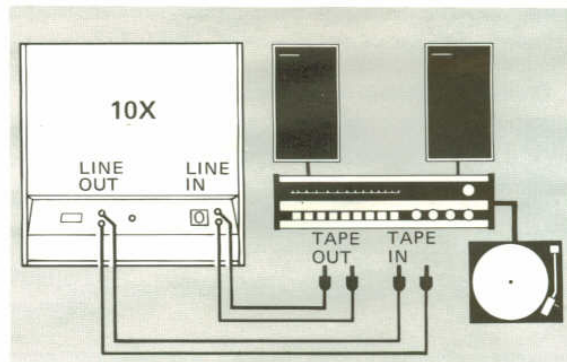

*One way of connecting the 10X for recording*

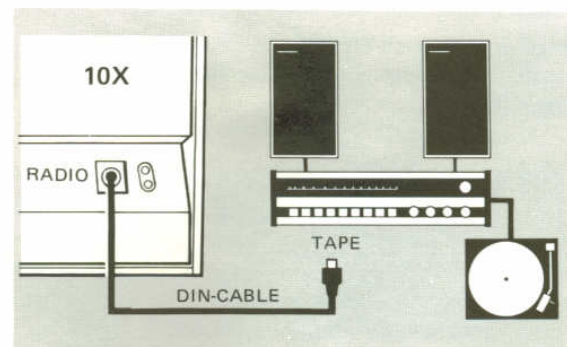

*An alternative way of connecting the 10X for recording*



starts. Adjust one or both LINE INPUT LEVEL knobs so that the meter(s) deflect(s) up to the red sector (0 dB). Deflection *into* the red sector is acceptable for the loudest passages.

If it is a record program, go through a trial run by playing the record before starting the actual recording. Adjust one or both LINE INPUT LEVEL knobs so that the meter(s) deflect(s) up to the red sector (0 dB). Deflection *into* the red sector is acceptable for the loudest passages.

With a stereo recording the two channels will often give different meter indications, but the *maximum* indication should be the same for both channels. To achieve this you may have to set one INPUT LEVEL knob higher than the other. *This is normal.*

7. If it is a radio program, start the recording by pressing the RECORD button. If it is a record program, start the recording by first starting the transcription unit and immediately after pressing the RECORD button.
8. Watch the level meter(s) and if necessary make small adjustments to the LINE INPUT LEVEL knobs, but slowly and gently.
9. Stop the recording by pressing the STOP button. Then release the REC SELECT button(s).

**NOTE!** When using 10½" spools, depress the 10½" REEL button. When using smaller spools, leave the button out.

LOUD PASSAGE      SOFT PASSAGE



*On records you can tell the loudest passages by looking at the record under light. The loud passages break up the light more than the soft passages*

### Flying start -- playback to record

For editing purposes or trick recordings you may wish to start a new recording immediately following something already recorded on the tape. Assuming that the machine is in the playback mode and that you have depressed REC SELECT L or R or both, to go from the playback mode to the record mode simply press the RECORD and PLAY buttons simultaneously.



*Flying start*

## Recording from microphones

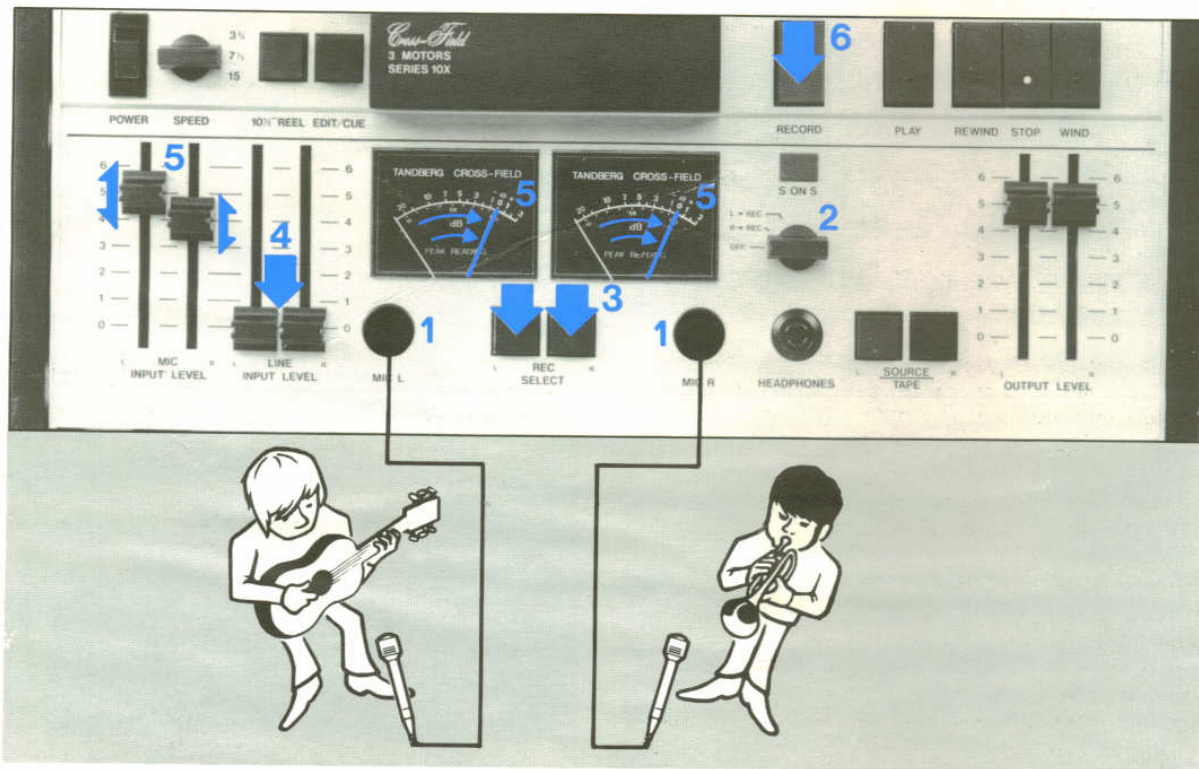

### Basic procedure

1. For mono or stereo recording connect one or two microphones respectively to one or both sockets marked MIC L and MIC R. Use microphones with an impedance between 200 and 700 ohms. The sensitivity of the MIC input circuit will automatically adjust itself to the impedance of the microphone.

2. Set the S ON S knob to OFF.

3. Depress both the REC SELECT buttons for a stereo recording, but only one button for a mono recording.

When only one REC SELECT button is depressed the programs from both MIC sockets are connected to that channel. When one microphone is used it can therefore be connected to either MIC socket, but convention dictates that MIC L be used for mono recordings and the first recording in a set of trick recordings.

4. Set the LINE INPUT LEVEL knobs to zero.

5. Speak, sing, or get the instrument to play while you adjust one or both MIC INPUT LEVEL knobs so that the meter(s) deflect(s) up to the red sector (0 dB), see diagram.

**NOTE!** If only one microphone is used, the MIC INPUT LEVEL knob which is not in use must be set to zero.

6. Start the recording by pressing the RECORD button.

7. Stop the recording by pressing the STOP button. Then release the REC SELECT button(s).

**NOTE!** When using 10½" spools, depress the 10½" REEL button. When using smaller spools, leave the button out.



### Placing microphones for a stereo recording

Two basic methods are in general use. In method A (see diagram) the two microphones are mounted quite close together on the same stand and angled away from each other. This method is more suitable for small groups of performers, a duet, a trio, chamber music, or two or three speakers, perhaps. The angle between the microphones should not be too great otherwise there will be an impression of lack of sound in the middle, the so-called "hole-in-the-middle effect". The microphones can be spaced at the same distance as the distance between human ears.

If possible, change the position and height of the microphones and the positions of the players and make trial recordings remembering to announce the conditions for every recording.

**NOTE!** Cardioid microphones must be used for this type of recording (see below).

In method B (see diagram) the microphones are placed on separate stands from 5 to 15 feet apart. This method is more suitable for larger groups of performers, an orchestra or a choir perhaps. Again there is a risk of the "hole-in-the-middle" effect if the distance between the microphones is too big. If possible, record the performers in their normal location with the audience present – the acoustics will be better. If there is a soloist his/her microphone will probably be better at about 3 feet while the microphone for the choir/orchestra may be better at 10 feet.

Circular microphones are well suited for this type of recording (see next paragraph).

### Microphone polar diagrams

The polar diagram tell you how sensitive the microphone is to sound from different directions. There are three main types:

1. Cardioid (uni-directional)
2. Figure-of-eight (bi-directional)
3. Circular (omni-directional)

A figure-of-eight microphone can be advantageous for recording two speakers, singers, or instrumentalists. A circular microphone is useful for larger orchestras and choirs, especially where it is important to include the acoustic coloration of the hall into the recording. A cardioid microphone can be used for practically any recording. It reduces unwanted reflected sounds from the back and sides of a hall, and this is often an advantage. However, this reduction of reflected sounds can sometimes be frequency dependent giving unwanted coloration from the microphone itself (some frequencies are emphasized more than others). This is particularly true of the cheaper cardioid microphones on the market.

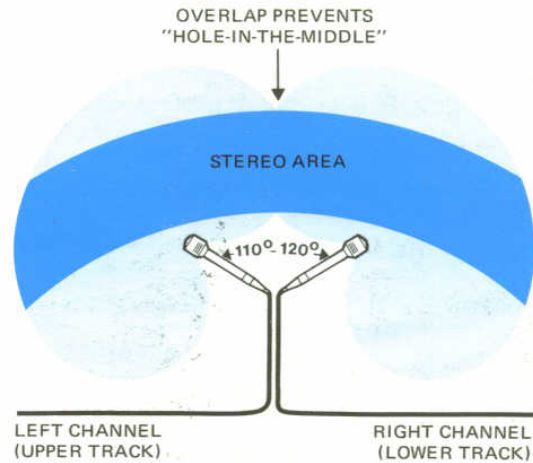

Method A – Cardioid microphone

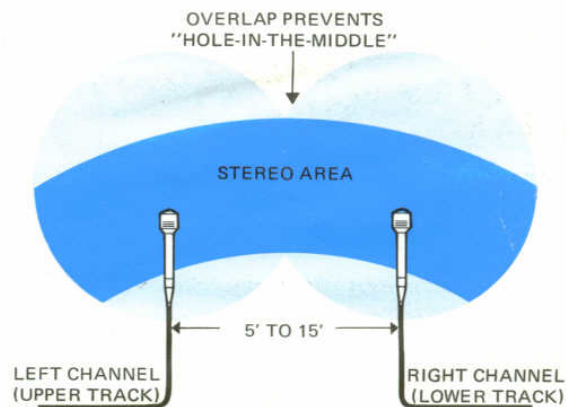

Method B – Circular microphone

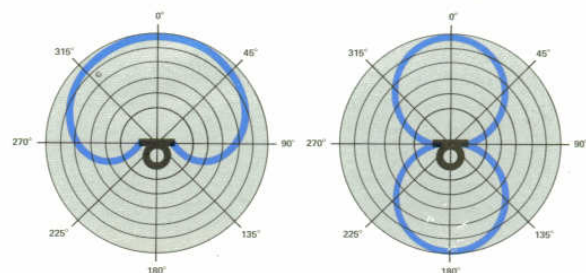

Cardioid

Figure-of-eight

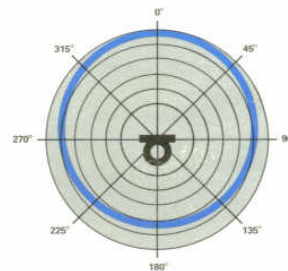

Circular

Suggested microphone positions for recording musical instruments

INSTRUMENT	MIC. POSITION
Upright piano	Best in a room with a long reverberation time. Place mic. 1' to 2' away from treble end of piano preferably behind it. Height should be 1' to 2' above top of piano. Difficult instrument. Pays to experiment.
Grand piano	See drawing below.
Violin family (including cello and double bass)	About 3' to 5' above instrument pointing at sound holes. If too close will pick up bow noises. See drawing below.
Woodwinds	Above player's head about 3' away pointing at finger holes or bell. Listen for "plopping" noises from stops and valves and experiment with microphone position to reduce them.
Brass	Pointing down at the bell from above the player at a distance of 5' to 7'. Halve the distance when using a mute.
Guitar	About 1' from sound holes. If too close will pick up finger scraping noises.
Percussion	Point at small drum from 2' to 3'. Wire brushes need a very good microphone. Set up recording conditions for percussion before dealing with other instruments.
Organ	Difficult instrument. Place in middle front level with longest pipe and the length of the pipe away. Pays to experiment.

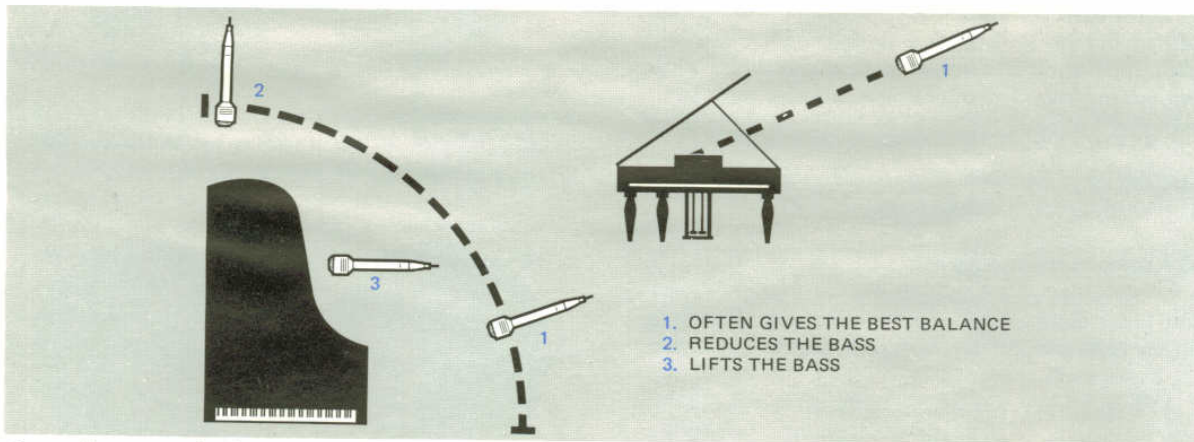

Recording a grand piano

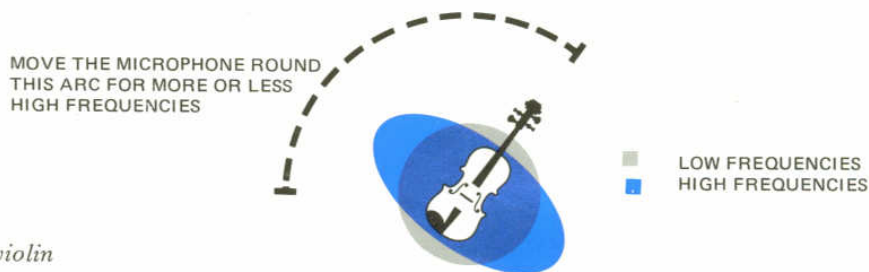

Recording a violin



## Copying tape

Connect the 10X to the second tape recorder via the RADIO or LINE sockets. If the RADIO socket is used a special reversal cable must be used (obtainable from most audio shops).

Copying can take place in either direction.

Some tape decks (e.g. Tandberg models 6X and 6000X) have a special output for copying tape. If you use this special output you do not need a reversal cable.

### Setting the INPUT LEVEL controls

Set the LINE INPUT LEVEL knobs on the recording machine between 3 and 4. Then adjust the output level controls on the playback machine to approximately correct level (0 dB reading on the meters of the recording machine). Finally, return to the LINE INPUT LEVEL controls on the recording machine to make the final adjustments.

**NOTE!** If the playback machine is not fitted with output level controls (e.g. Tandberg 3300X), the output signal from the machine will in most cases be too strong for the RADIO input of the 10X. In this case, use the LINE IN inputs which are less sensitive.

### Tips on copying

- Make a trial run before starting the recording to establish the correct setting of the level controls on the machine used for recording.
- Always start the machine used for recording first.
- Copying can also take place via your receiver/amplifier, but in this event you should follow the receiver/amplifier instruction book.
- You can edit the tape being played back without cutting if you stop the recording tape recorder and allow the playback tape recorder to run. You can eliminate clicks by turning down the level control on the recording tape recorder just before either machine (or both) is/are stopped. This method of editing is only suitable for removing longer pieces of unwanted recordings.

When only one REC SELECT button is depressed the programs from both MIC sockets are connected to that channel. When one microphone is used it can therefore be connected to either MIC socket, but convention dictates that MIC L be used for mono recordings and the first recording in a set of trick recordings.

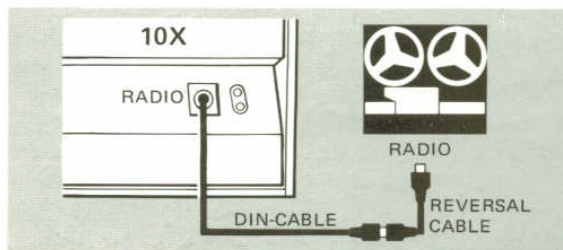

Using DIN cables

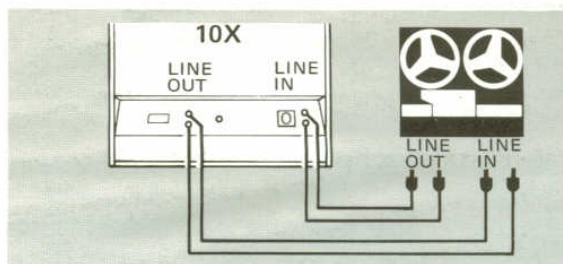

Using phono cables

## Sound-on-Sound

The Sound-on-Sound recording technique allows a program played back from one track to be mixed with another program and re-recorded on another track on the same tape. With this technique you can add your own voice to a recording of an orchestra, you can sing in many voices by adding one voice after another, or you can play many instruments forming a band with yourself as the only musician.

Assuming that the first program will be recorded on the top track (left channel), Sound-on-Sound recording can be carried out as follows (voices are used in this example):

Disconnect any other equipment connected to the 10X via the LINE IN or RADIO sockets.

1. Microphones can be connected to MIC L or MIC R sockets or both. If you connect two microphones the 10X will act as a straight-forward mixer for the microphones. In this example we assume that one microphone is connected to MIC L socket for the sake of simplicity.
2. Connect headphones to the HEADPHONES socket and turn up OUTPUT LEVEL L and R for a comfortable listening level on the headphones.

### Recording the first voice

1. Reset the counter.
2. Set the knobs and buttons as indicated in the diagram on the right.
3. Sing into the microphone and adjust MIC INPUT LEVEL L to get 0 dB on the left level meter.
4. Press the RECORD button and make the recording.

### Adding a second voice

1. Rewind to zero on the counter.
2. First set the REC SELECT and SOURCE/TAPE buttons as indicated in the diagram on the right. Then set the S ON S knob to L → REC.
3. Sing into the microphone and adjust the level on the right-hand meter to *slightly less than 0 dB* by means of MIC INPUT LEVEL L.



■ = IN      □ = OUT

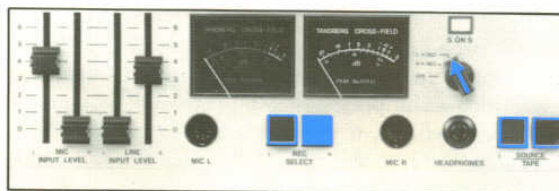

■ = IN      □ = OUT



4. Press the RECORD button. You will now hear the first voice on the headphones. Adjust LINE INPUT LEVEL R to be *slightly less than 0 dB* on the meter. Make a trial recording by singing into the microphone and adjusting MIC INPUT LEVEL L and LINE INPUT LEVEL R so that the level of the combined voices is not more than 0 dB. Wind back to zero.
5. Press the RECORD button and make the recording.
6. Rewind to zero, set the S ON S knob to OFF, and depress SOURCE/TAPE R. Press the PLAY button and listen. If you are not satisfied, repeat steps 2 to 5.

### Adding a third voice

The procedure for adding a third voice is the same as for adding a second voice, except that steps 2 and 6 change to:

2. First set the REC SELECT and SOURCE/TAPE buttons as indicated in the diagram on the right. Then set the S ON S knob to R → REC.

6. Rewind to zero, set the S ON S knob to OFF, and depress SOURCE/TAPE R. Press the PLAY button and listen.

A **fourth** voice can be added in the same way as the second voice and a **fifth** voice in the same way as the third voice.

**IMPORTANT!** When playing back a Sound-on-Sound recording the S ON S knob must be set to OFF.

Sound-on-Sound recordings are easier to make if two people are involved. Each person should have headphones (connected via a junction box that does not present an impedance of less than 8 ohms to the 10X). The second person can operate the controls while the first person simply sings or plays into the microphone. If you do not have a junction box, one pair of headphones can be connected to the LINE OUT sockets.

The impedance of these headphones should not be less than 100 ohms.

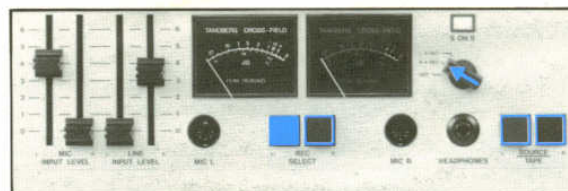

■ = IN      □ = OUT

## Language learning

The Sound-on-Sound technique can be used for language learning. The following procedure assumes that a master program\* has been pre-recorded on channel L.

### Recording your exercises

Disconnect any other equipment connected to the 10X via the LINE IN or RADIO sockets.

1. Connect a microphone to the MIC L socket and headphones to the HEADPHONES socket.
2. Set OUTPUT LEVEL L and R for a comfortable listening level in the headphones (about 3 or 4 perhaps).

3. First set the REC SELECT and SOURCE/TAPE buttons as indicated in the diagram on the right. Then set the S ON S knob to L → REC.

4. Speak into the microphone and adjust to 0 dB on the right-hand meter by means of MIC INPUT LEVEL L.

Set LINE INPUT LEVEL R between 3 and 4.

5. Press the RECORD button. You will hear the master program in your headphones and the level can be adjusted with LINE INPUT LEVEL R.

Listen to the program and repeat the exercises during the gaps.

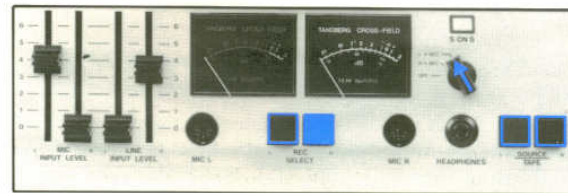

■ = IN      □ = OUT

### Playback and comparison

1. Rewind to the beginning of the program.

2. First set the S ON S knob to OFF. Then set the REC SELECT and SOURCE/TAPE buttons as indicated in the diagram on the right.

3. Listen and compare your recorded exercises with the master program.

If you are not satisfied with your performance, rewind the tape and repeat the exercises as explained above.

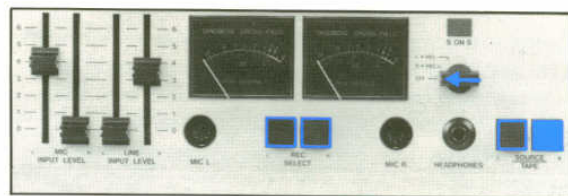

■ = IN      □ = OUT

\* A master program is a recording with "native" voices of phrases and sentences to be practised by the student. Between each sentence there is a suitable gap (about 1½ times as long as it takes to say the sentence) to give the student time to repeat. Pre-recorded master programs are available, but you can also record the program yourself from a school broadcast or gramophone record.



## Echo

Recording with echo or reverberation can be achieved in many different ways. It is possible to use mechanical aids (e.g. vibrating plate, a magnetic drum, a tape loop, an echo box, an echo chamber) or electronic circuits (e.g. an analog shift register). It is not possible to go into details of these methods in this book.

However, with 10X you can make echo recordings without recourse to the aforementioned aids. A mono recording with echo can be made on the left or right channel, and the length of the echo is dependent on the speed of the tape. A speed of 15 ips will normally give the most "natural" effect.

### Recording with echo on the left channel

Disconnect any other equipment connected to the 10X via the LINE IN or RADIO sockets.

1. Connect a microphone to the MIC L socket and headphones to the HEADPHONES socket. (You can use two microphones, but for the sake of simplicity we assume one is being used).
2. Set OUTPUT LEVEL L and R for a comfortable listening level.

3. First set the REC SELECT and SOURCE/TAPE buttons as indicated in the diagram on the right. Then set the S ON S knob to L→REC.

4. Sing into the microphone and adjust MIC INPUT LEVEL L to *slightly less than* 0 dB on the left-hand meter.
5. Press the RECORD button. Sing and monitor the effect on the headphones. Adjust the echo level with LINE INPUT LEVEL R and, if necessary, re-adjust MIC INPUT LEVEL L so that the 0 dB mark is not exceeded too much and too often.

**NOTE!** If LINE INPUT LEVEL R is turned up too much, the echo "takes over" completely and spoils the recording.

### Recording with echo on the right channel

The procedure is the same as for recording on the left channel, except that step 3 changes to:

3. First set the REC SELECT and SOURCE/TAPE buttons as indicated in the diagram on the right. Then set the S ON S knob to R→REC.

Echo can also be superimposed on any program connected to LINE IN L. Adjust the recording level with LINE INPUT LEVEL L and the echo level with LINE INPUT LEVEL R.

**IMPORTANT!** When playing back an echo recording the S ON S knob must be set to OFF.

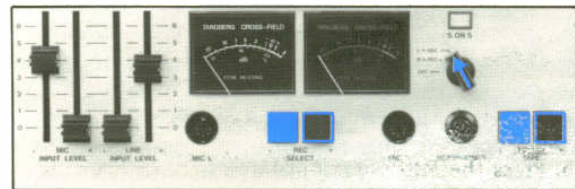

■ = IN

□ = OUT

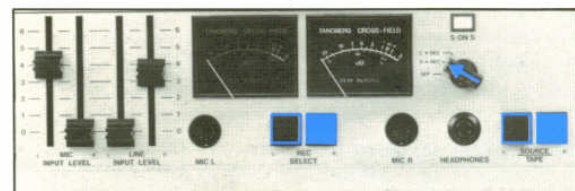

■ = IN

□ = OUT

## Mixing

Two stereo programs or four mono programs can be mixed and recorded simultaneously and you can have full control over the mixing ratios on the 10X.

### Mixing two stereo programs

A stereo program from microphones can be mixed with a stereo program from another source (receiver, disc, or tape, for example) connected to either the RADIO socket or the LINE IN L and R sockets on the 10X.

Adjust the level of the microphone program with the MIC INPUT LEVEL L and R knobs. Adjust the level of the other program with the LINE INPUT LEVEL L and R knobs. The level for both programs combined must not exceed 0 dB on the meter.

The performer making the microphone recording should monitor the other program on headphones plugged into the 10X (both SOURCE/TAPE buttons out). Two sets of headphones connected to the 10X (via a junction box which should not present an impedance less than 8 ohms to the headphones socket) will enable a second person to operate the tape recorder instead of the performer. The second set of headphones can also be connected to the LINE OUT sockets. The impedance of these headphones should not be less than 100 ohms.

### Mixing four mono programs

Two mono programs from microphones can be mixed with two mono programs from other sources connected to either the RADIO socket (L and R channels) or the LINE IN L and R sockets on the 10X (a second tape recorder and a transcription unit are used in our example).

Adjust the level of each program with the corresponding INPUT LEVEL knob. If only one REC SELECT button is depressed, all four programs will be recorded on one track.

The meter deflection for all four programs combined must not exceed 0 dB.

Mixing two or more programs can be useful for superimposing a commentary onto music or sound effects onto a film, or a still picture program. It is also an interesting alternative to sound-on-sound.

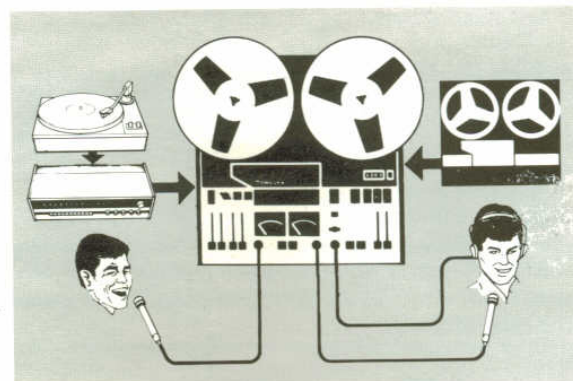
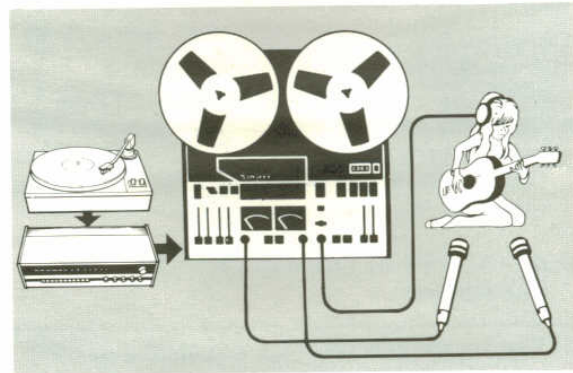
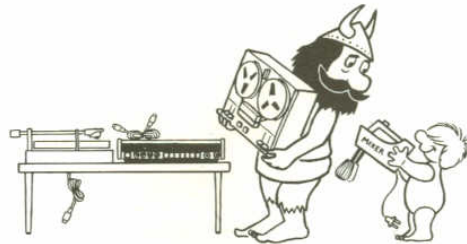



## The 10X used as an amplifier

The 10X can be used as a microphone amplifier or a mixer unit for a microphone program and a music program. You can also play back a mono tape and use the 10X as a microphone amplifier at the same time. This facility is useful for department stores, auditoria, exhibitions, discotheques, and similar places where there is a need to distribute music interrupted by announcements without stopping the tape recorder.

### Microphone amplifier

1. Connect microphone(s) to the MIC socket(s) and set the REC SELECT and SOURCE/TAPE buttons as follows:

	REC SELECT	SOURCE/TAPE
Mono	Depress one button	Both buttons out
Stereo	Depress both buttons	Both buttons out

2. Set OUTPUT LEVEL L and R to maximum.
3. Connect the 10X to an amplifier/receiver via the RADIO or LINE sockets and depress the TAPE button on the amplifier/receiver. Speak into the microphone and your speech will be reproduced over the loudspeakers connected to the amplifier/receiver. Control the volume with the MIC INPUT LEVEL knob(s) on the 10X and the VOLUME control on the amplifier/receiver.

**NOTE!** Do not place the microphone too near the speakers as this may lead to acoustic feedback.

### Mixer unit for microphones and music

If the associated amplifier/receiver has a TAPE button (or TAPE MONITOR button), a microphone program from the 10X can be mixed with another program from the amplifier/receiver. In this example we have chosen a program from a record player connected to the amplifier/receiver, but it could equally well be a radio program, or tape program from another tape deck.

The procedure is the same as for the "Microphone amplifier" except that step 3 becomes:

3. Connect the 10X to the amplifier/receiver via the RADIO or LINE sockets. Connect the record player to the amplifier/receiver.

Depress the PHONO button on the amplifier/receiver. Then depress the TAPE (or TAPE MONITOR) button. Adjust the volume of the record player program (music program) with the LINE INPUT LEVEL knobs and the volume of the microphone program with the MIC INPUT LEVEL knob(s). Set the INPUT LEVEL knobs which are not used to zero. Use the VOLUME control on the amplifier/receiver if necessary.

**NOTE!** This procedure cannot be used if the receiver/amplifier is designed so that the PHONO button is released when the TAPE (MONITOR) button is pressed.

### Mixed playback/amplifier mode

A mono program can be played back from the 10X while it is also in use as a microphone amplifier:

1. Both the SOURCE/TAPE buttons should be out.
2. Set the S ON S switch to L→REC to play back from the left channel and to R→REC to play back from the right channel.
3. Connect a microphone to MIC L or MIC R and depress either of the REC SELECT buttons.
4. Set OUTPUT LEVEL L and R to maximum.
5. Depress the TAPE (or TAPE MONITOR) button on the amplifier/receiver.
6. Press the PLAY button. The playback program and the microphone program will be mixed and reproduced through the amplifier/receiver.

Adjust the volume of the playback program with the LINE INPUT LEVEL R knob. Adjust the level of the microphone program with the respective MIC INPUT LEVEL knob.

**NOTE!** The RECORD button must not be pressed and the S ON S switch must be returned to OFF when you have finished with this mode of operation.

## Locating a program on tape and editing

### Tape counter

When recording, set the counter to zero at the beginning of the tape and write down the counter number at the start of each recorded item. This will make it easier to locate a specific item later on.

Always use the same empty spool to get an accurate reading on the counter.

### EDIT/CUE during WIND or REWIND

Depress the EDIT/CUE button to listen to the tape during wind or rewind. The SOURCE/TAPE buttons must be depressed and the OUTPUT LEVEL must be turned up. With practice you will learn to recognize the sound of speeded up recordings and this technique will give you a fast way of roughly locating any item.

The level of the sound is high, therefore do not set the OUTPUT LEVEL controls too high.

### EDIT/CUE for precision editing

For editing you may need to locate a place on the tape accurately. Play back the tape and press the STOP button to stop the tape as near as possible to the place where you wish to edit. Depress the EDIT/CUE button, turn the tape reels by hand and listen on headphones or loudspeakers to find when the exact place for editing is at the playback head. If you want to start a new recording immediately after this place, turn the tape reels so that the tape moves 1" to the left, and start the new recording. You may need to move the tape slightly more than 1" — or slightly less — depending on the tape speed, your experience, and the precision you require.

The 15 ips speed is well suited for editing.

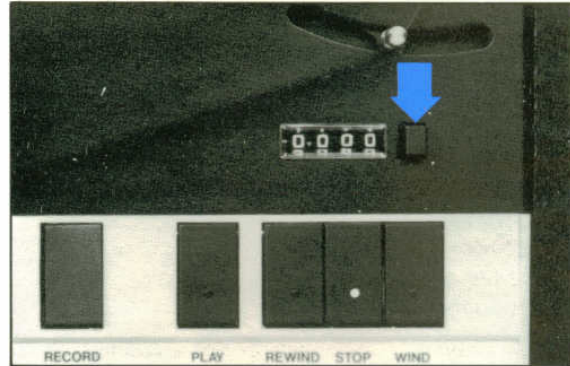

*Resetting the counter*

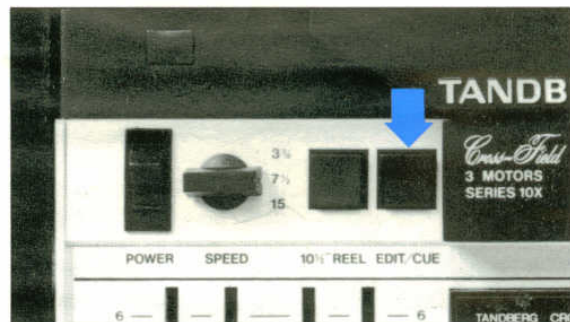

*EDIT/CUE button*



*Turn the tape reels by hand*



## Cutting and splicing

You may need to cut and splice a tape to get the recorded items into a particular order. You may also need to remove small imperfections from a recording such as a cough or a wrong note.

1. Locate the cutting place as described under "EDIT/CUE for precision editing".
2. Pull off the front head cover with "Cross-Field" printed on it.
3. Use a soft pen (felt or fibre) or a chinagraph pencil to mark the tape at the playback head, (see figure). This mark indicates where the tape should be cut and spliced.
4. Lay one tape end over the other with the same sides of the tape uppermost. Cut the tape at the mark with scissors or knife (non-magnetic!) at an angle of  $45^\circ$  as shown in the figure. Do not handle the tape unnecessarily.
5. Lay the tape ends against each other to form a butt joint (no gap, no overlap) with the shiny side up (unless the tape has a matt backing when the matt backing should be up). Lay the splicing tape across the joint, parallel to the cut, and press firmly to squeeze out air bubbles (see figure).
6. Cut the splicing tape along both sides of the joint with a slight curving action into the magnetic tape to prevent the adhesive being deposited on the heads (see figure).

**WARNING. Use a special splicing tape supplied by audio shops. Ordinary sticky tapes may damage the tape deck.**

Splicing will also be necessary for leader tape and if the tape breaks.

Cutting and splicing cannot be performed if there are programs of value on other tracks.

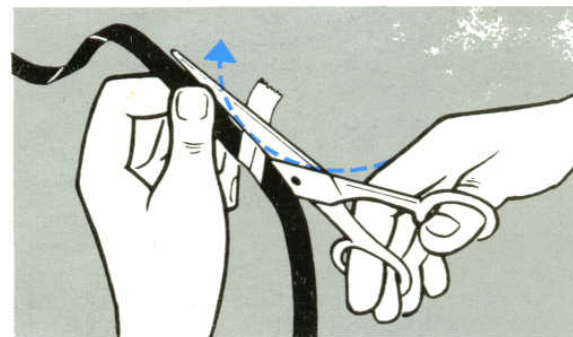
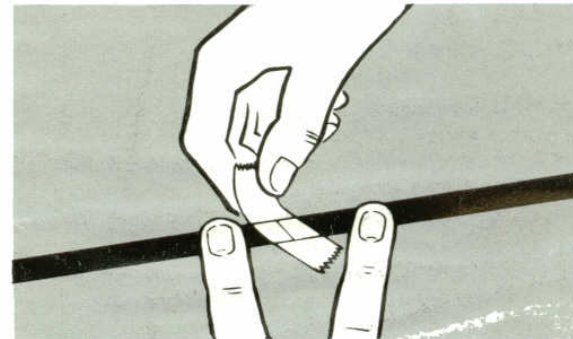
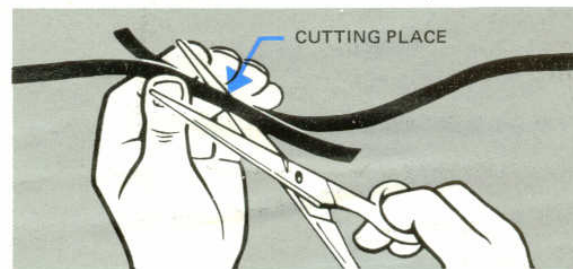
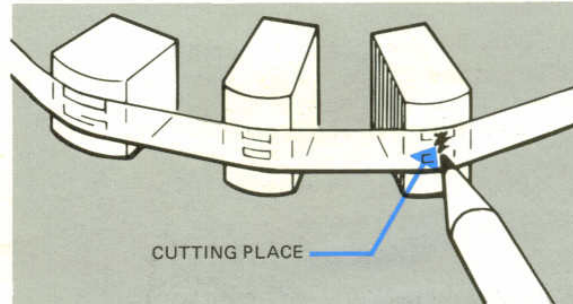

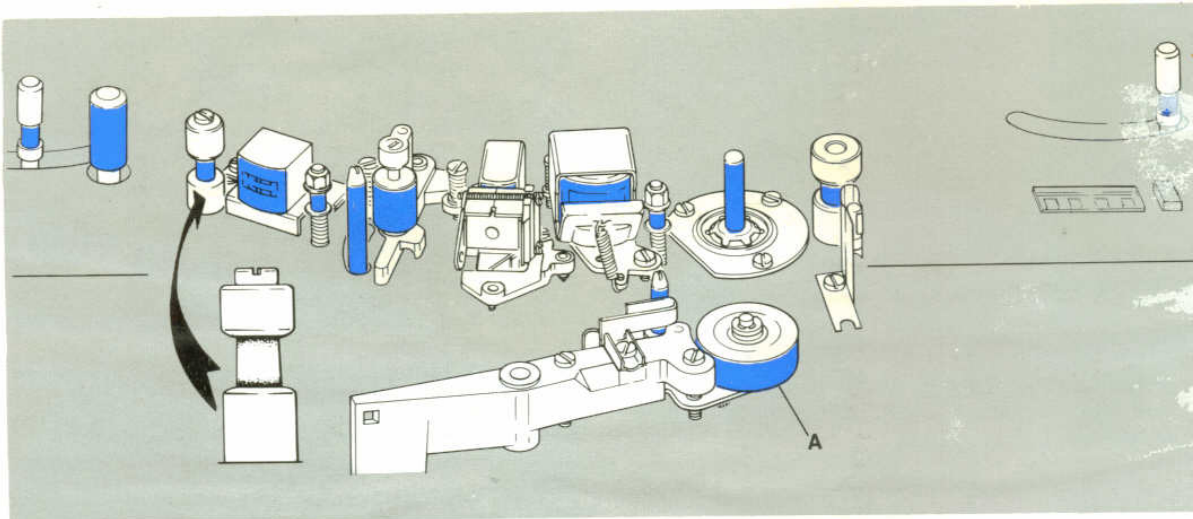

*Clean the spots indicated in color*

### Cleaning

The parts of the tape deck in contact with the tape surface should be cleaned regularly, otherwise the sound quality will be greatly reduced.

**When to clean.** If the tape deck is used every day, cleaning should be performed at least once a month. A good time to clean is just before making an important recording.

**What to use.** The cleaning can be done with cotton-wool or a piece of flannel wrapped around a small stick and moistened with pure alcohol or methylated spirit. A kit intended for this purpose "Tandberg Professional Tape Head Cleaner", is available.

Aerosols (spray cleaners) intended for video tape recorders can be used, but it is not sufficient just to spray the parts. Cottonwool buds must also be used.

**NOTE!** Do not use solvents, such as acetone or trichlorethylene, as they may damage the heads. Do not use any sharp objects.

**How to clean.** Remove the two head covers by pulling them straight upwards. Clean the spots indicated in color in the figure. Pay particular attention to the sharp corners of the tape guide posts where deposits tend to settle.

Stubborn deposits on guide-posts should first be softened and afterwards removed with a toothpick.

The pinch roller (A) needs to be cleaned only if the tape motion is uneven or if there are visible deposits on the roller (four to six times a year will be satisfactory for even a frequently used machine). Dry the roller after cleaning.

Finally, remove dust and loose magnetic particles from the area around the parts you have cleaned.

**DO NOT TOUCH THE ADJUSTMENT SCREWS.**

### Degaussing

A marked increase in background noise from the tape may indicate that the heads or other parts in the tape path should have the residual magnetism removed (degaussing).

If required, degaussing should be carried out as follows. Switch off the deck. Remove the two head covers and move the degausser slowly past each one of the metal parts normally in contact with the tape. Take great care not to let the degausser touch the heads or metal parts in the tape path. Do not switch off the degausser until it is at least 3 ft from the recorder. Alternatively, follow the degausser maker's instructions.



# Block diagram

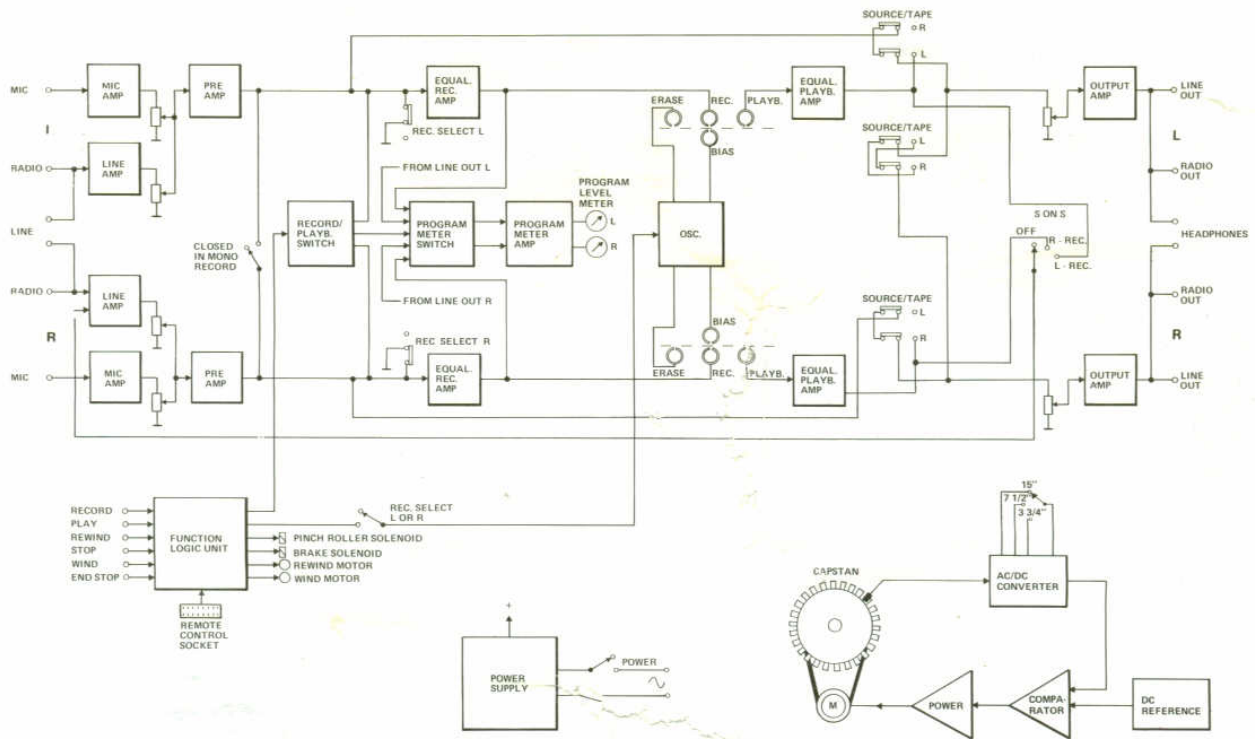

## Useful data

### Plugs

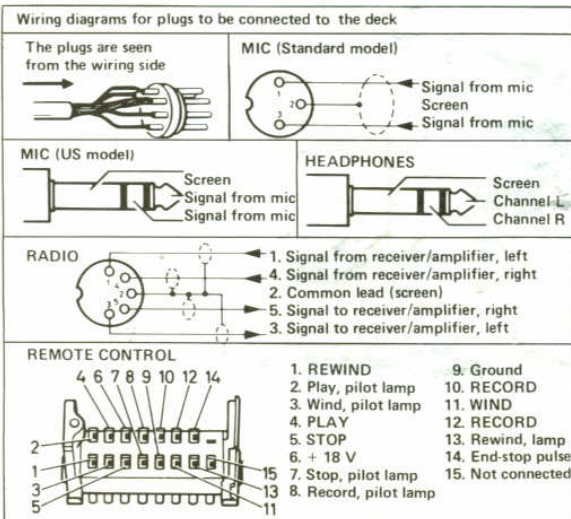

### Inputs

Input impedance/sensitivity max. voltage at 400 Hz. (MIC. inputs are suitable for dynamic microphones. The sensitivity is automatically adjusted for the MIC. impedance).

Standard:	MIC: 0.23 mV-35 mV
	RADIO: 50 kohm/8 mV-1.2 V
	LINE: 200 kohm/30 mV-4.5 V
U.S.A.:	MIC: 0.5 mV-75 mV
	RADIO: 50 kohm/30 mV-4.5 V
	LINE: 200 kohm/100 mV-5 V

### Outputs

Load impedance/voltage and unloaded output or power output for each channel.

RADIO	5 kohm/0.775 V
LINE	150 ohm/1.5 V
HEAD- PHONES	8 ohm/5 mW