

AM/FM STEREO TUNER

TX-6500II

SERVICE MANUAL



 PIONEER

MODEL TX-6500II COMES IN FOUR VERSIONS DISTINGUISHED AS FOLLOWS:

Type	Voltage	Remarks
KC	120V only	CSA (Canada) approved with de-emphasis selector switch (25 μ s/75 μ s)
KU	120V only	UL (U.S.A.) approved with de-emphasis selector switch (25 μ s/75 μ s)
HG	220V and 240V (Switchable)	SEMKO (Sweden), NEMKO (Norway), DEMKO (Denmark) and EI (Finland) approved
S	110V, 120V, 220V and 240V (Switchable)	General export model with de-emphasis selector switch (25 μ s/50 μ s/75 μ s)

NOTES:

- Service information for TX-6500II/KC, KU are described on page 5 through 36 in this manual.
- For servicing of S and HG types please refer to TX-6500II/KC, KU manual with the exception of descriptions in the "Additional Service Manual" (p.37~p.62).

CONTENTS

1.	SPECIFICATIONS	5
2.	FRONT PANEL FACILITIES	6
3.	CONNECTION DIAGRAM	6
4.	DISASSEMBLY	7
5.	PARTS LOCATION	
5.1	Front Panel View	8
5.2	Front View with Panel Removed	9
5.3	Top View	10
5.4	Rear Panel View	11
6.	BLOCK DIAGRAM	12
7.	CIRCUIT DESCRIPTIONS	
7.1	AM Tuner	13
7.2	FM Tuner	13
7.3	Muting Circuit	15
8.	ADJUSTMENTS	
8.1	AM Section	16
8.2	FM Section	17
9.	DIAL CORD STRINGING	19
10.	EXPLODED VIEW	20

11.	SCHMATIC DIAGRAMS, P.C. BOARD PATTERNS AND PARTS LIST	
11.1	Schematic Diagram and Miscellaneous Parts	23
11.2	Tuner Assembly (AWE-062)	27
11.3	Power Supply Assembly (AWR-097) KU Type	33
11.4	Power Supply Assembly (AWR-137) KC Type	34
12.	PACKING	36
Additional Service Manual of HG and S Types		
1.	S TYPE	
1.1	Schematic Diagram and Miscellaneous Parts	38
1.2	Tuner Assembly (AWE-088)	41
1.3	Switch Assembly (AWX-114)	47
1.4	Power Supply Assembly (AWR-134)	48
2.	HG TYPE	
2.1	Schematic Diagram and Miscellaneous Parts	50
2.2	Tuner Assembly (AWE-087)	53
2.3	Power Supply Assembly (AWR-124)	59
3.	CONTRAST OF MISCELLANEOUS PARTS	61

1. SPECIFICATIONS

Semiconductors

FET	1
ICs	3
Transistors	7
Diodes	9

FM Section

Circuitry	1 FET, 1-stage RF Amplifier 3-gang variable capacitor, 5- stage limiter, PLL MPX.
Usable Sensitivity	Mono: 10.7dBf (1.9 μ V)
50dB Quieting Sensitivity	Mono: 14dBf (2.8 μ V) Stereo: 38dBf (44 μ V)
Signal to Noise Ratio at 65dBf	Mono: 75dB Stereo: 68dB
Distortion at 65dBf:	
100Hz	Mono: 0.15% Stereo: 0.3%
1kHz	Mono: 0.15% Stereo: 0.3%
10kHz	Mono: 0.2% Stereo: 0.6%
Frequency Response	30Hz to 10kHz ^{+0.3} / _{-0.3} dB 20Hz to 15kHz ^{+0.2} / _{-1.0} dB
Capture Ratio	1.0dB
Alternate Channel Selectivity	60dB
Spurious Response Ratio	75dB
Image Response Ratio	60dB
IF Response Ratio	90dB
AM Suppression Ratio	50dB
Muting Threshold	10dBf (1.7 μ V)
Stereo Separation	40dB (1kHz), 30dB (30Hz to 15kHz)
Subcarrier Product Ratio	62dB
SCA Rejection Ratio	62dB
Antenna Input	300ohms balanced 75ohms unbalanced

AM Section

Circuitry	1-stage RF amplifier, 2-gang variable capacitor
Sensitivity:	
(IHF, Ferrite antenna)	300 μ V
(IHF, Ext. antenna)	15 μ V
Selectivity	35dB
Signal to Noise Ratio	50dB
Image Response Ratio	40dB
IF Response Ratio	70dB
Antenna	Built-in ferrite loopstick an- tenna

Audio Section

Output Level/Impedance:	
FM	650mV/4.6k Ω (100% MOD)
AM	150mV/5.4k Ω (30% MOD)

Miscellaneous

Power Requirements	120V, 60Hz
Power Consumption	14W
Dimensions	380(W)x139(H)x322(D)mm 15x5-1/2x12-11/16in.
Weight:	
Without package	5.6kg (12lb 5oz)
With package	6.8kg (14lb 15oz)

Furnished Parts

FM T-type Antenna	1
Connection Cord with Pin Plugs	1
Hex. Wrench (used for fastening TUNING knob)	1
Operating Instructions	1

NOTE:

Specifications and the design subject to possible modification without notice due to improvements.

2. FRONT PANEL FACILITIES

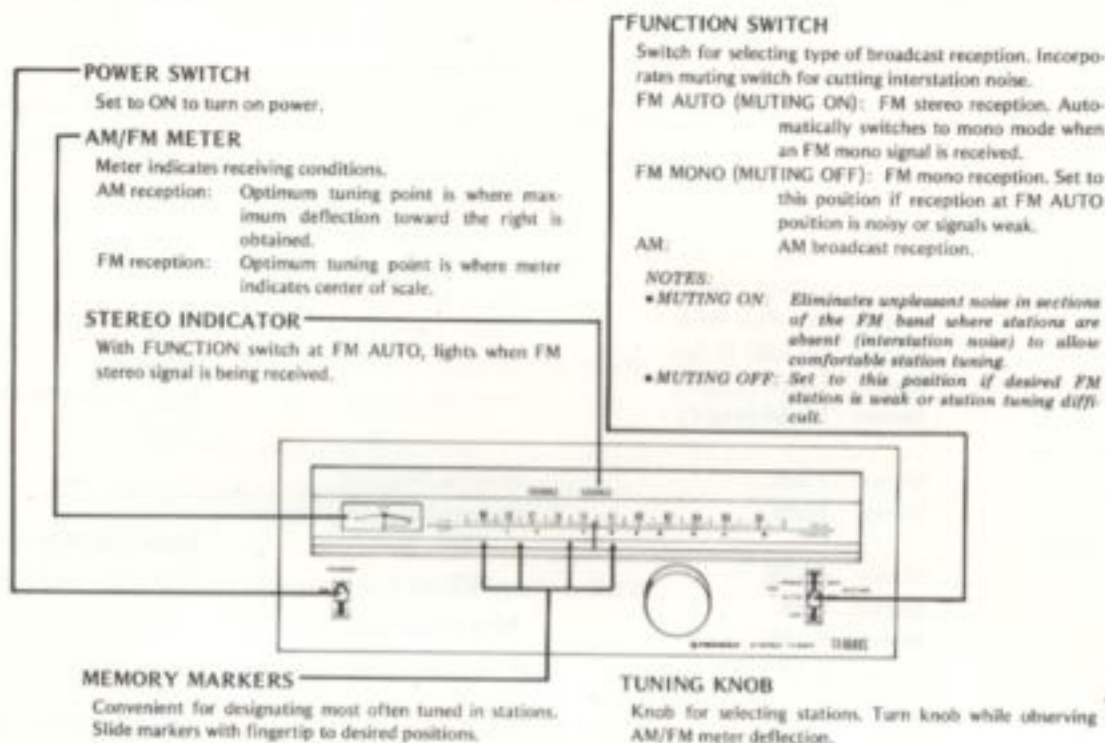

3. CONNECTION DIAGRAM

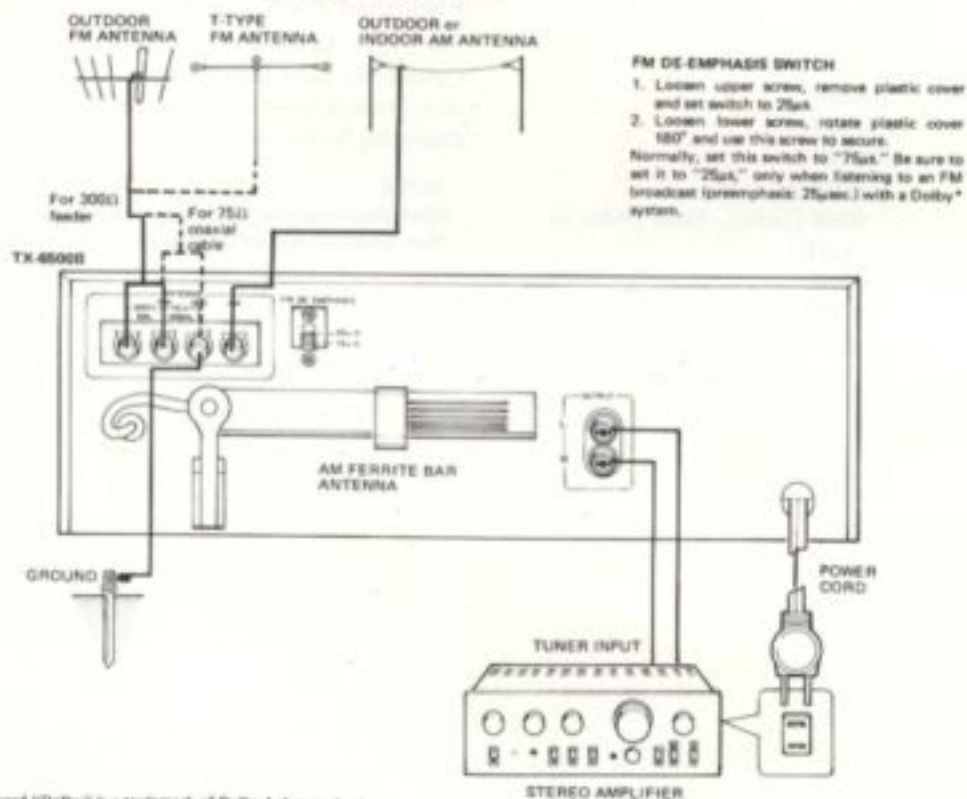

* The word "Dolby" is a trademark of Dolby Laboratories Inc.

4. DISASSEMBLY

Removing the Top Cover

Remove the two screws (A) on each side of the top cover.

Removing the Bottom Plate

Remove the eight screws (B) to detach the bottom plate.

Removing the Front Panel

1. Loosen the setscrew of TUNING knob with a hexagonal wrench.
2. Remove all the knobs by pulling.
3. Remove the four screws (C) from the top and bottom edges of the front panel.

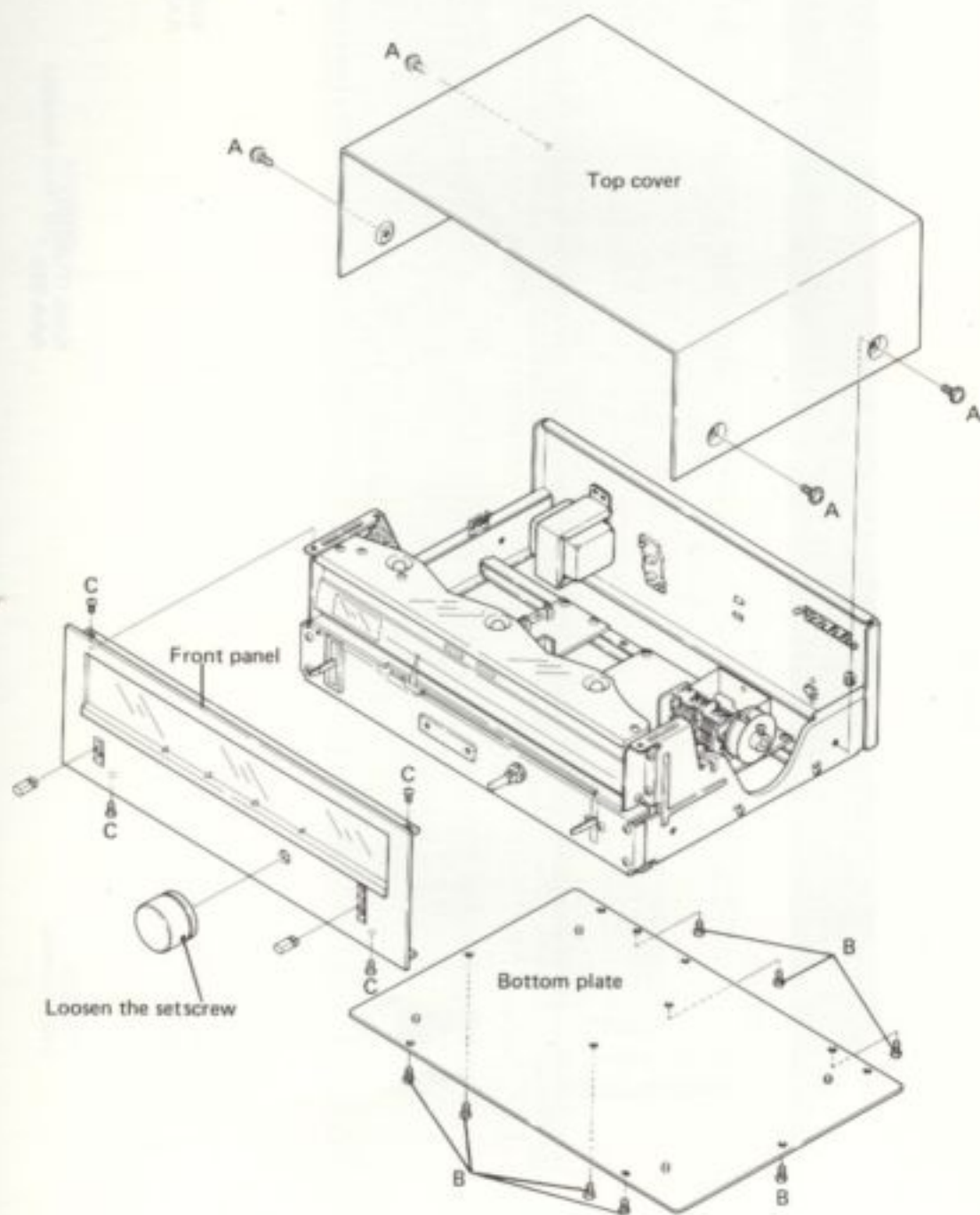

5. PARTS LOCATION

5.1 FRONT PANEL VIEW

Front panel assembly
ANB-486

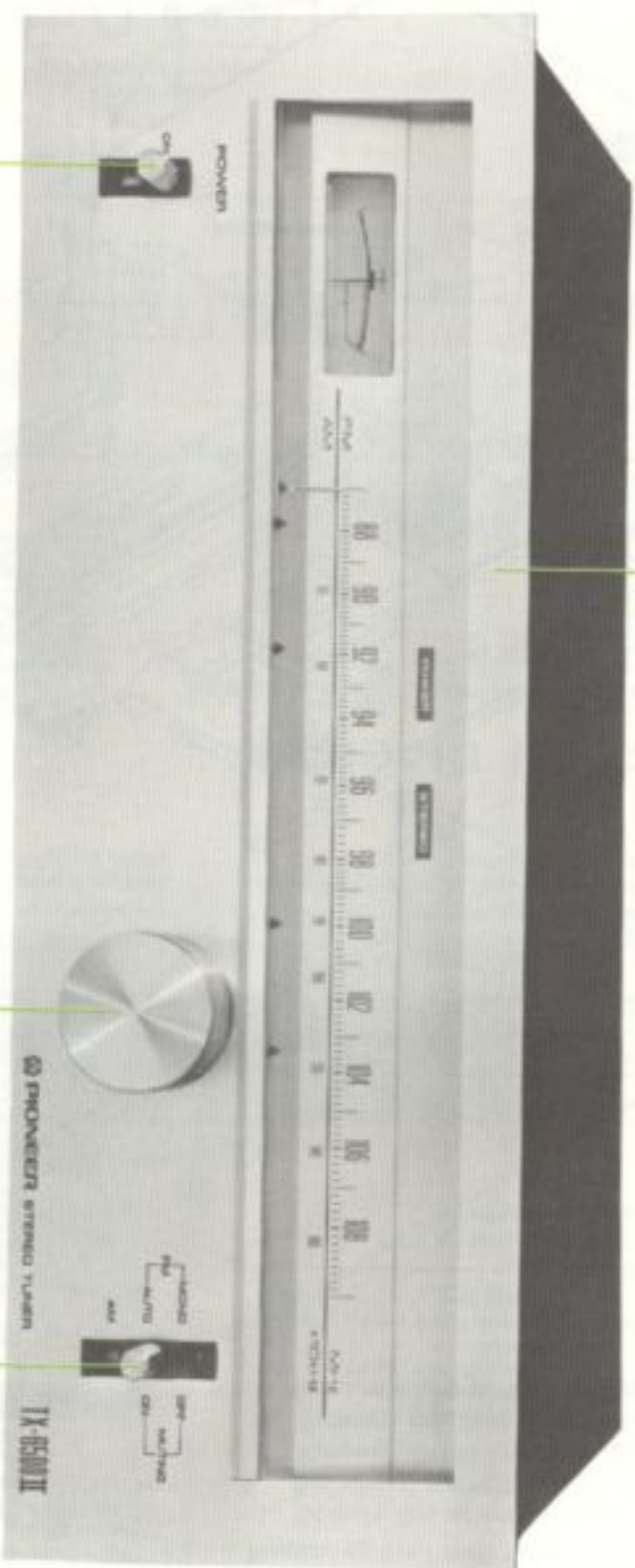

Knob (POWER)
AAD-115

Knob (TUNING)
AAA-035

Knob (FUNCTION)
AAD-115

5.2 FRONT VIEW WITH PANEL REMOVED

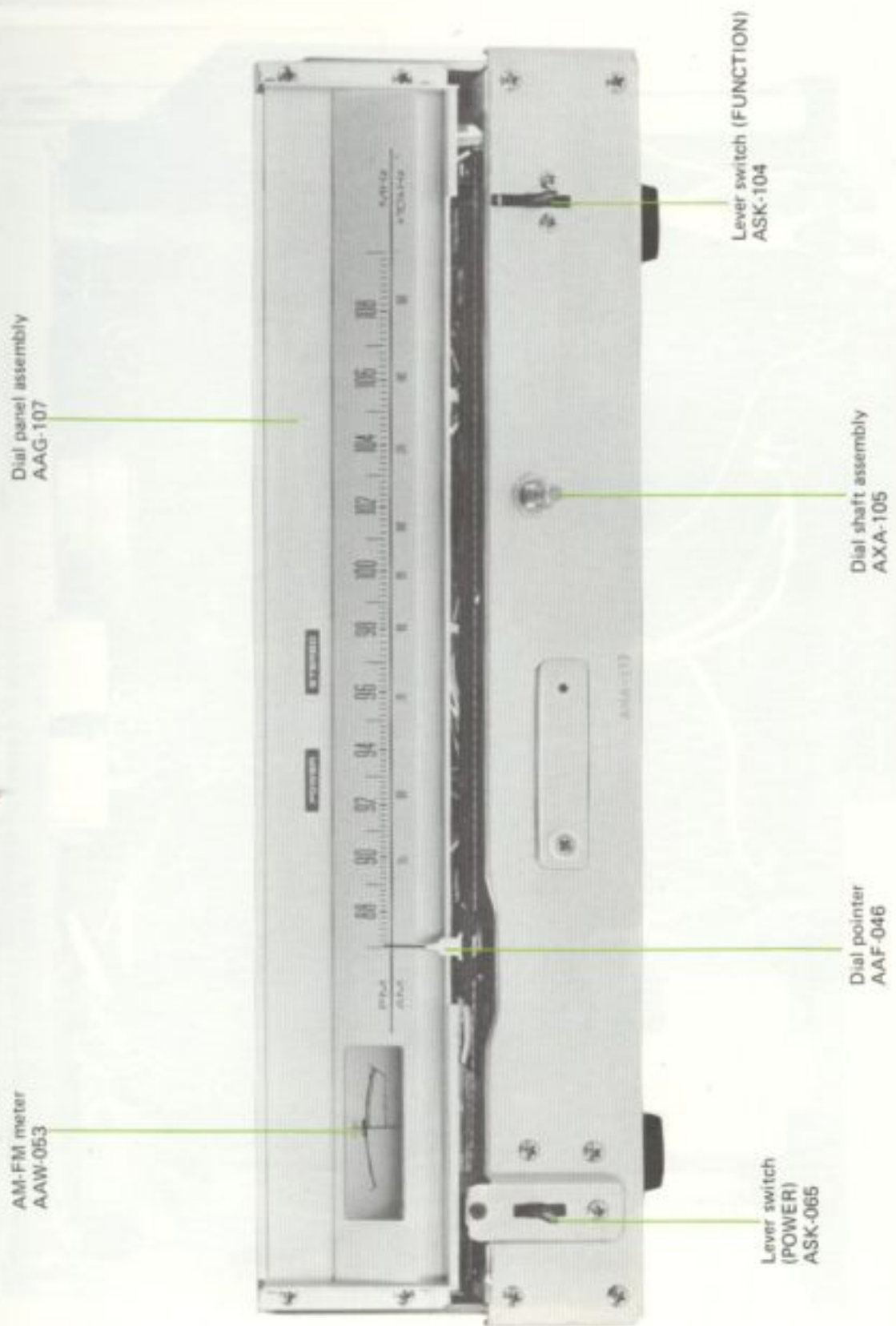

AM-FM meter
AAW-053

Dial panel assembly
AAG-107

Lever switch
(POWER)
ASK-065

Lever switch (FUNCTION)
ASK-104

Dial pointer
AAF-046

Dial shaft assembly
AXA-105

5.3 TOP VIEW

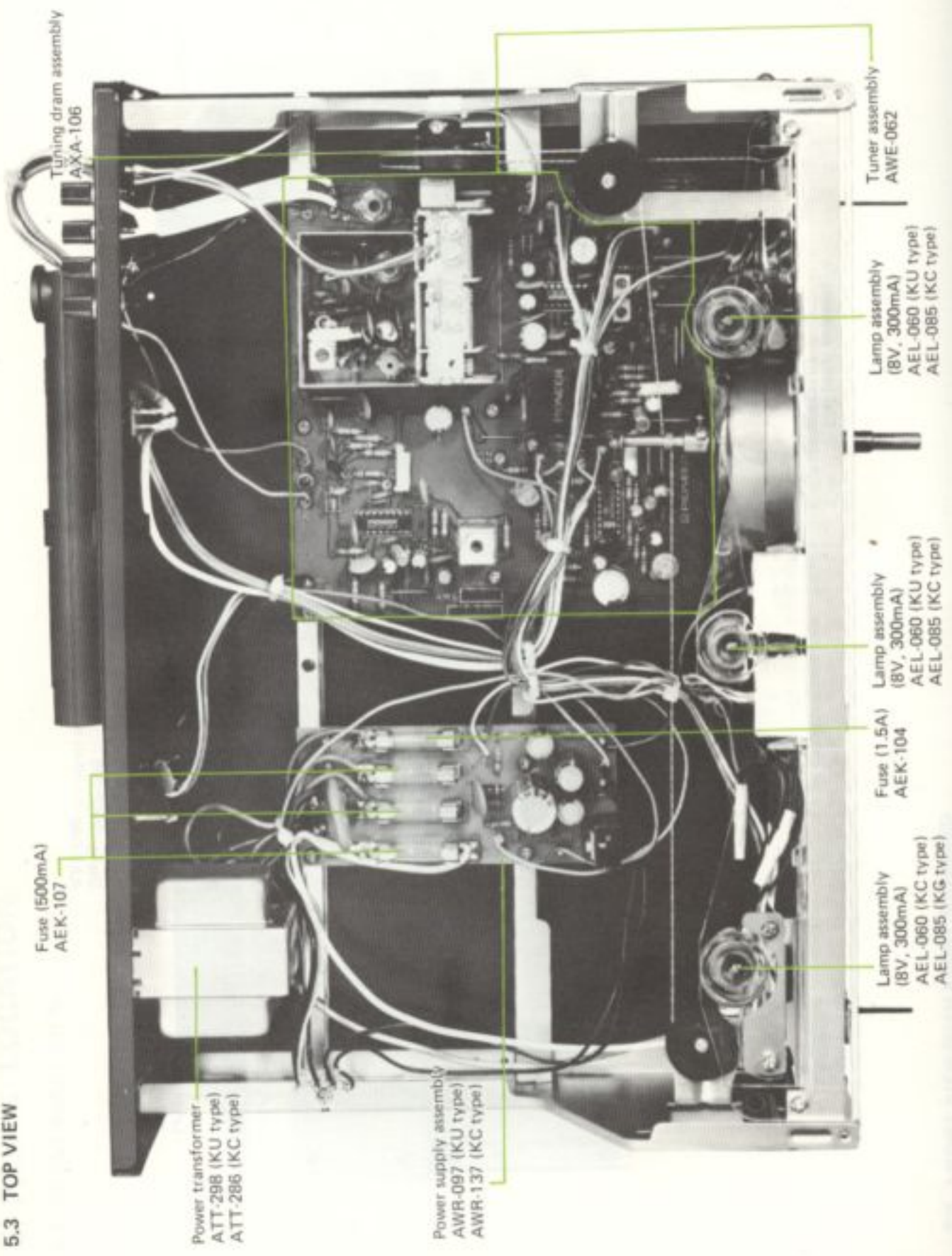

Fuse (500mA)
AEK-107

Power transformer
ATT-298 (KU type)
ATT-285 (KC type)

Power supply assembly
AWR-097 (KU type)
AWR-137 (KC type)

Tuning drum assembly
AXA-106

Lamp assembly
(8V, 300mA)
AEL-060 (KC type)
AEL-085 (KG type)

Fuse (1.5A)
AEK-104

Lamp assembly
(8V, 300mA)
AEL-060 (KU type)
AEL-085 (KC type)

Lamp assembly
(8V, 300mA)
AEL-060 (KU type)
AEL-085 (KC type)

Tuner assembly
AWE-062

7. CIRCUIT DESCRIPTIONS

5.4 REAR PANEL VIEW

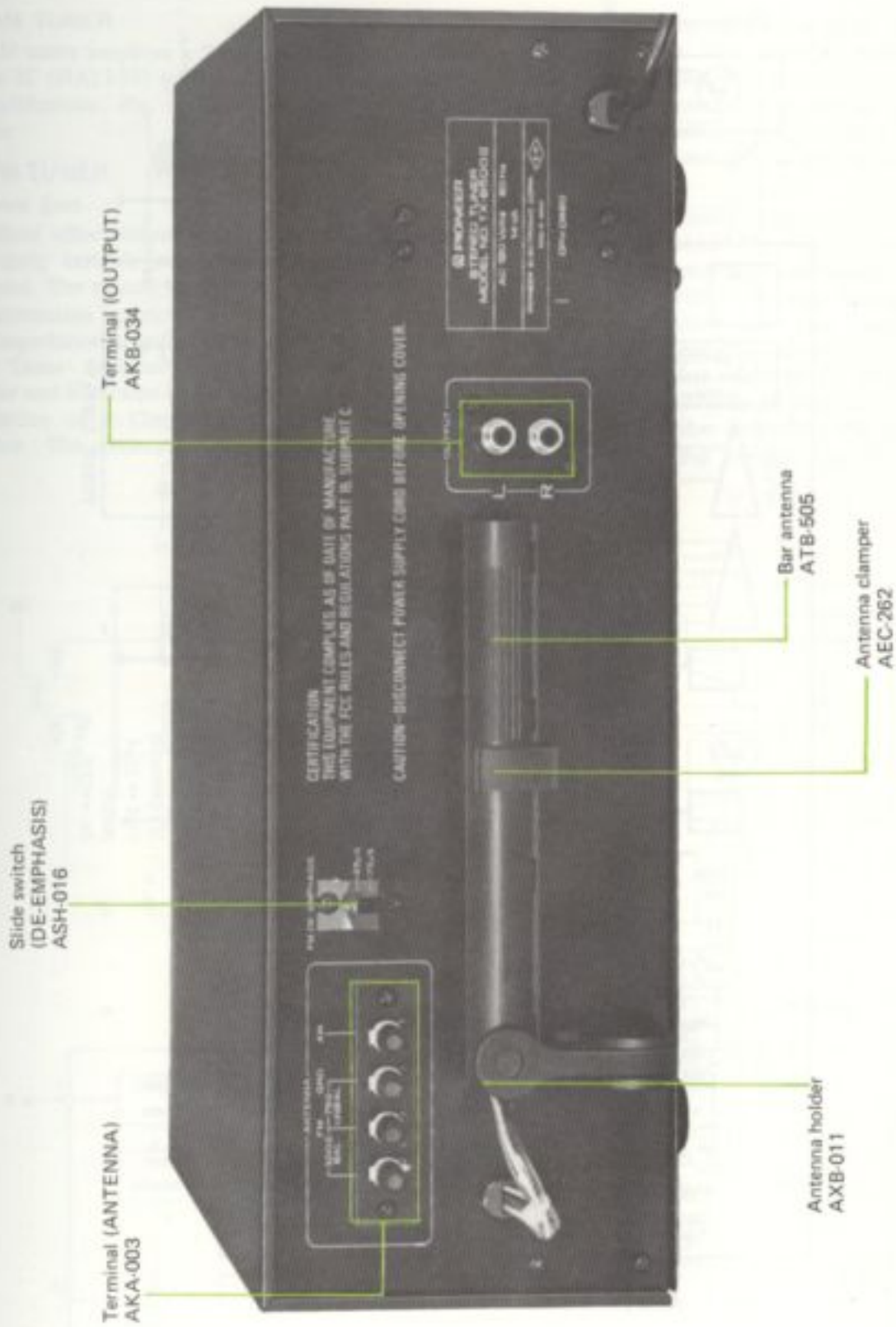

6. BLOCK DIAGRAM

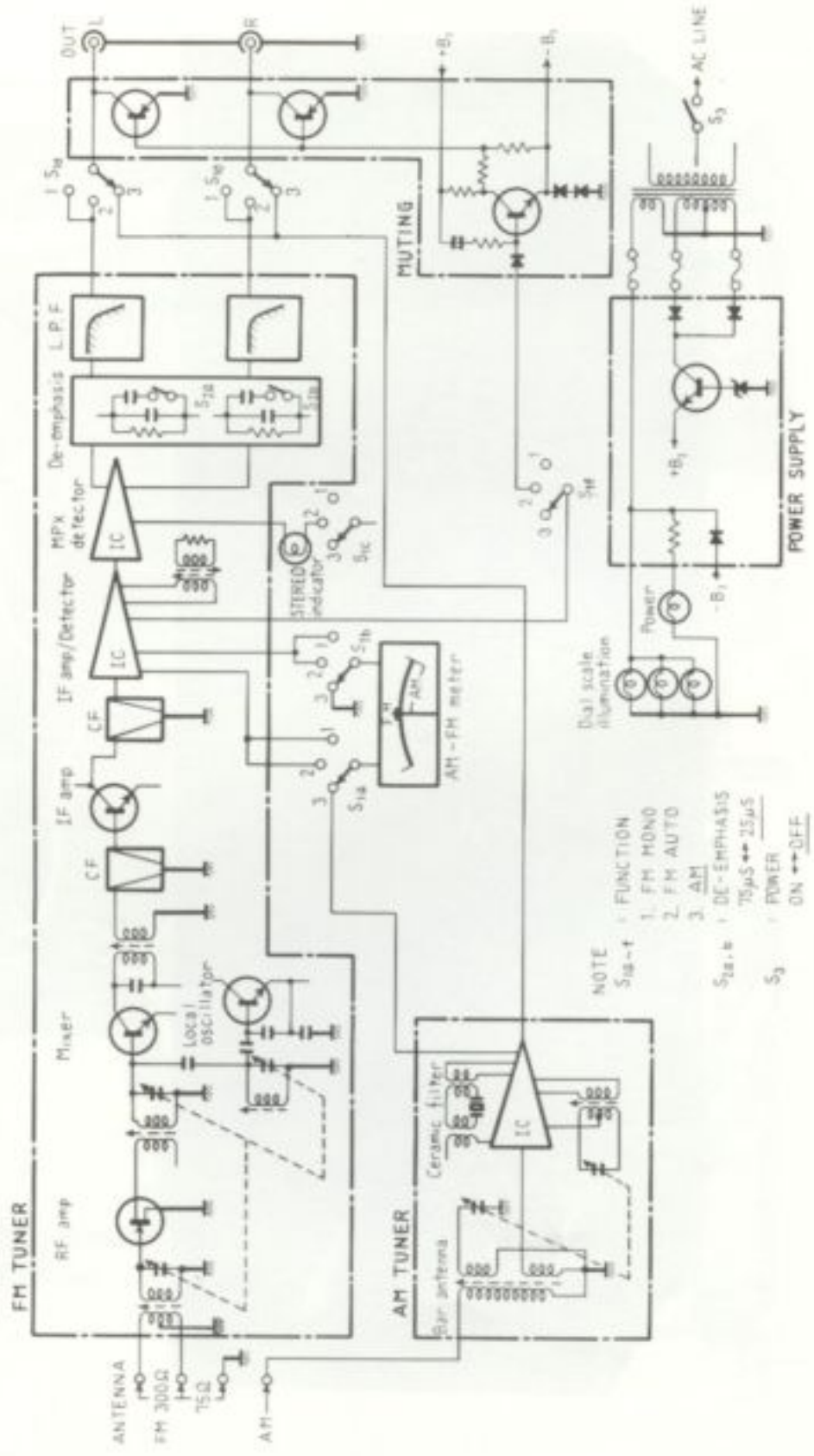

7. CIRCUIT DESCRIPTIONS

7.1 AM TUNER

The AM tuner employs a 2-gang variable capacitor and an IC (HA1138) with 1-stage RF and 2-stage IF amplification. Fig. 1 shows the HA1138 block diagram

7.2 FM TUNER

FM Front End

FET (field effect transistor) RF amplifier 1-stage and 3-gang variable capacitor tuning circuit are employed. The square transfer characteristic of the FET minimizes spurious signals, while the high input impedance provides an advantage in terms of noise. These features allow favorable spurious response and S/N ratio to be obtained.

A variation of a Clapp circuit forms the local oscillator. The generated signal passes from the

tuning circuit through a low value capacitor and is applied to the base of the mixing transistor. Advantages of this circuit include slight frequency drift due to variations in power source voltage, ambient temperature, etc., and low spurious interference in the clean output waveform.

FM IF Amplifier

This section consists of two dual element ceramic filters, an IC (HA1137) and a transistor. Ceramic filters possess excellent selectivity, which cannot be obtained with L-C type tuning filters. The circuit composition uses this quality to provide outstanding selectivity. Excellent sensitivity and S/N ratio are also achieved by employing a transistor and high density IC (HA1137). The HA1137 contains IF limiter amplifier, FM detector, meter drive and muting circuits. Its block diagram is shown in Fig. 2

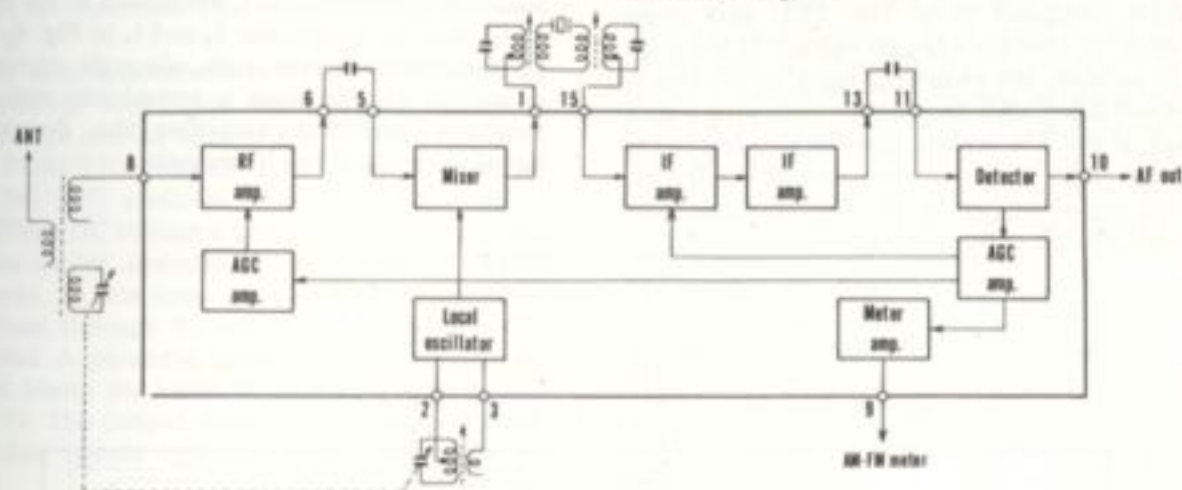

Fig. 1 Block Diagram of HA1138

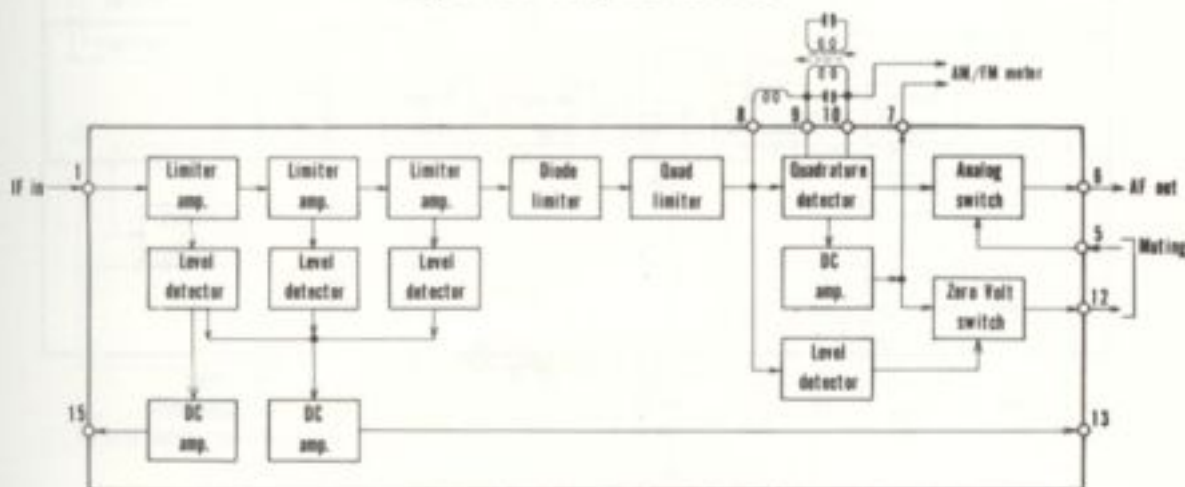

Fig. 2 Block Diagram of HA1137

Multiplex Decoder

This is composed of three sections and employs an IC (HA1196). The block diagram is shown in Fig. 3

1. Switching Signal Generator

A PLL (phase locked loop) system is employed. The 76kHz is generated by a VCO (voltage controlled oscillator: an oscillator in which frequency is controlled by a voltage) and converted into two 38kHz by a frequency divider, then converted again to become 19kHz. This signal and the stereo pilot component (19kHz) of the detected signal are applied to a phase comparator where the difference between them is converted into a voltage. By feedback of this voltage to the VCO, the oscillation signal becomes locked to the pilot signal. This loop is termed PLL and from here a 38kHz switching signal synchronized to the pilot signal is obtained.

2. Automatic Stereo Detector

Presence or absence of the pilot signal is detected by 19kHz obtained from the PLL and phase comparator to operate a trigger circuit. If the pilot signal is present, the switching signal is applied to the demodulator and the Stereo indicator lights. However, if the FM muting signal is also applied to pin 12, the detector circuit becomes grounded up. Switching signal supply to the demodulator stops and mono reproduction is obtained.

3. Demodulator

Two differential amplifiers are employed in a switching circuit (Fig. 4). The composite signal is applied to the base of Q_3 , Q_1 and Q_2 are alternately switched ON and OFF by the switching signal. The composite signal amplified at Q_3 is demodulated by the switching of Q_1 and Q_2 . Q_6 and Q_5 are loosely coupled at their emitters by R_1 , R_2 and R_3 . Q_6 is driven in opposite phase to Q_3 and its low level composite signal output is demodulated by switching of Q_4 and Q_5 . The demodulated signals in opposite phase are combined at the collectors of Q_1 and Q_2 , cancelling crosstalk. Adequate current flow is required in Q_3 and Q_6 for low distortion. However, if the base bias voltage is raised, the voltage range available at the collector is reduced and clipping occurs (power supply voltage is limited by IC voltage requirement). For this reason, current from an external source is inserted at Q_3 and Q_6 collectors and become I_1 and I_2 in Fig. 4. The same amount of current is removed at the emitters of Q_3 and Q_6 to become I_3 and I_4 in Fig. 4. Q_3 and Q_6 therefore operate with adequate current and distortion in this stage is remarkably reduced. A feedback amplifier amplifies the demodulated signal to produce the IC outputs.

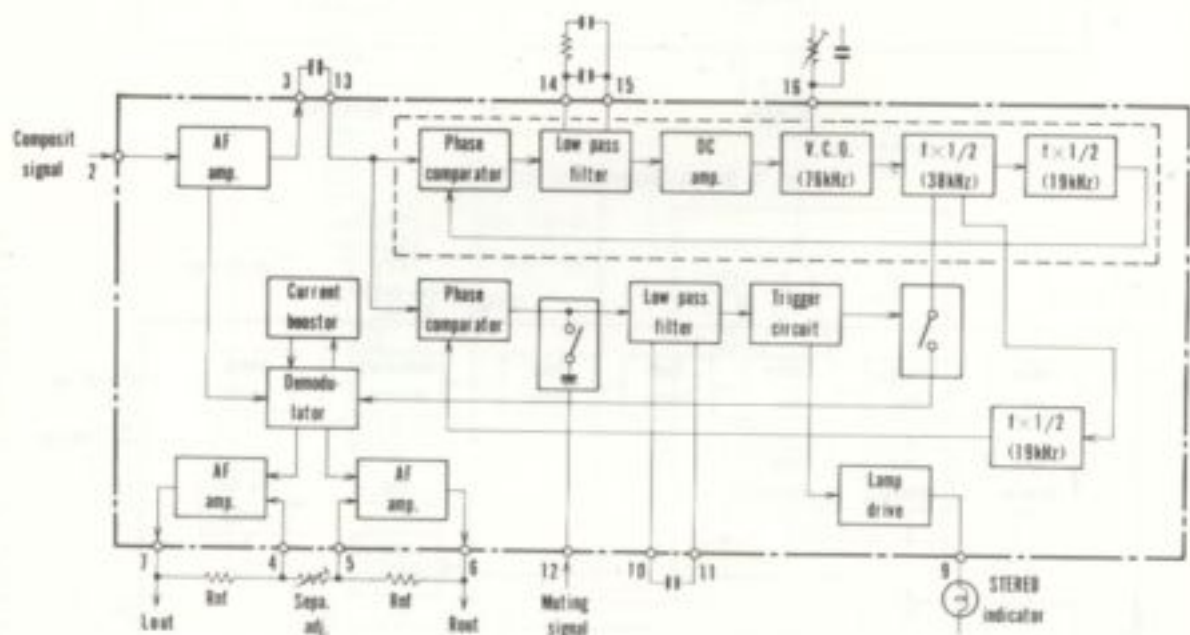

Fig. 3 Block Diagram of HA1196

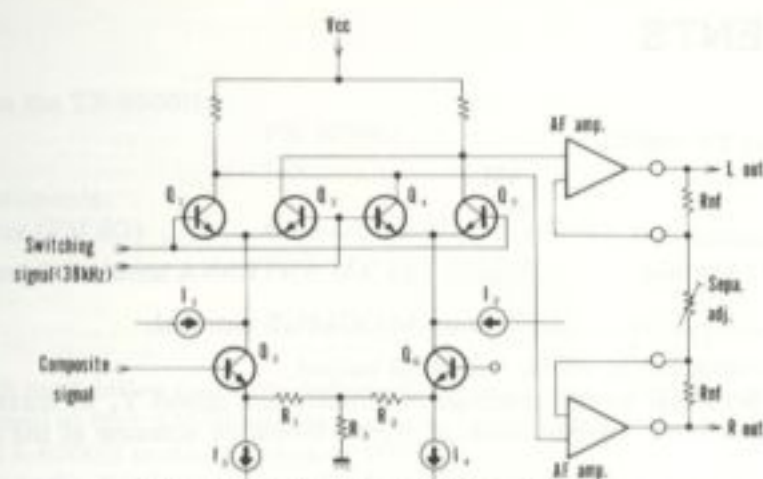

Fig. 4 Equivalent Circuit of Demodulator

7.3 MUTING CIRCUIT

In addition to muting FM interstation noise, the muting circuit combines functions for reducing noise incurred when the POWER and FUNCTION switches are operated. This muting circuit is shown in Fig. 5.

At more than approximately $\pm 70\text{kHz}$ detuning or an extremely low input level, a DC voltage is produced at pin 12 of the FM IF IC (HA1137). If the FUNCTION switch is set to the FM AUTO (MUTING ON) position, pin 12 is connected to pin 5. When DC voltage is produced, the IC internal analogue switch operates to provide the MUTING ON mode. At this time, since pin 12 is connected to Q_1 base through R_1 and D_1 , Q_1 becomes ON and point A potential drops. Consequently, $-B_1$ forward biases the bases of Q_2 and Q_3 , switching them ON. The output signals then flow to ground. Since this circuit operates faster than the IC

(HA1137) internal muting circuit, pop noise produced during FM tuning and detuning becomes reduced.

POWER switch ON muting: Q_1 is forward biased by $+B_2$ through C_1 and R_2 , and becomes switched ON. For this reason, $-B_1$ forward biases the bases of Q_2 and Q_3 through R_7 , and these transistors become switched ON. Several seconds after the POWER switch has been set to ON, Q_1 base voltage declines and Q_1 becomes switched OFF. This causes $+B_2$ to flow in the route $R_4 \rightarrow R_7 \rightarrow -B_1$ and bases of Q_2 and Q_3 become reverse biased. The transistors are switched OFF and normal operation is attained.

POWER switch OFF muting: $+B_1$ immediately declines after the POWER switch is set to OFF. Point A potential accompanies $+B_1$ variation through C_2 and R_5 and it also declines. Consequently, Q_2 and Q_3 are forward biased by $-B_1$ and become ON.

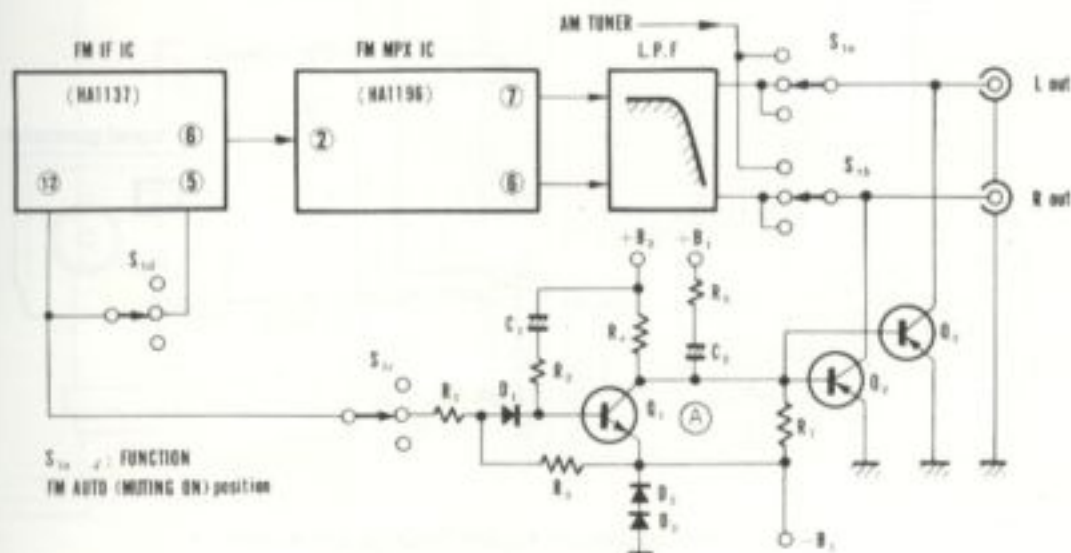

Fig. 5 Circuit Diagram of Muting Circuit

8. ADJUSTMENTS

8.1 AM SECTION

1. Switch position on the TX-6500II:
FUNCTION AM
POWER ON
 2. Connection of instruments:
AM Signal Generator (AM SG) Connect to AM ANTENNA terminal through a $1k\Omega$ resistor.
AC Voltmeter } Connect to OUTPUT terminal.
Oscilloscope }
 3. Set AM SG to 30% modulation at 400Hz and 30dB output.
 4. Tune AM SG and TX-6500II to dial readings of 600kHz and adjust T_6 to maximize audio frequency output level. (Adjust core of ferrite loopstick antenna at the same time.)
 5. Tune AM SG and TX-6500II to dial readings of 1,400kHz and adjust TC_5 and TC_4 to maximize audio frequency output level.
- Repeat steps 4 and 5 so that output is maximized when the dial indicates these frequencies.

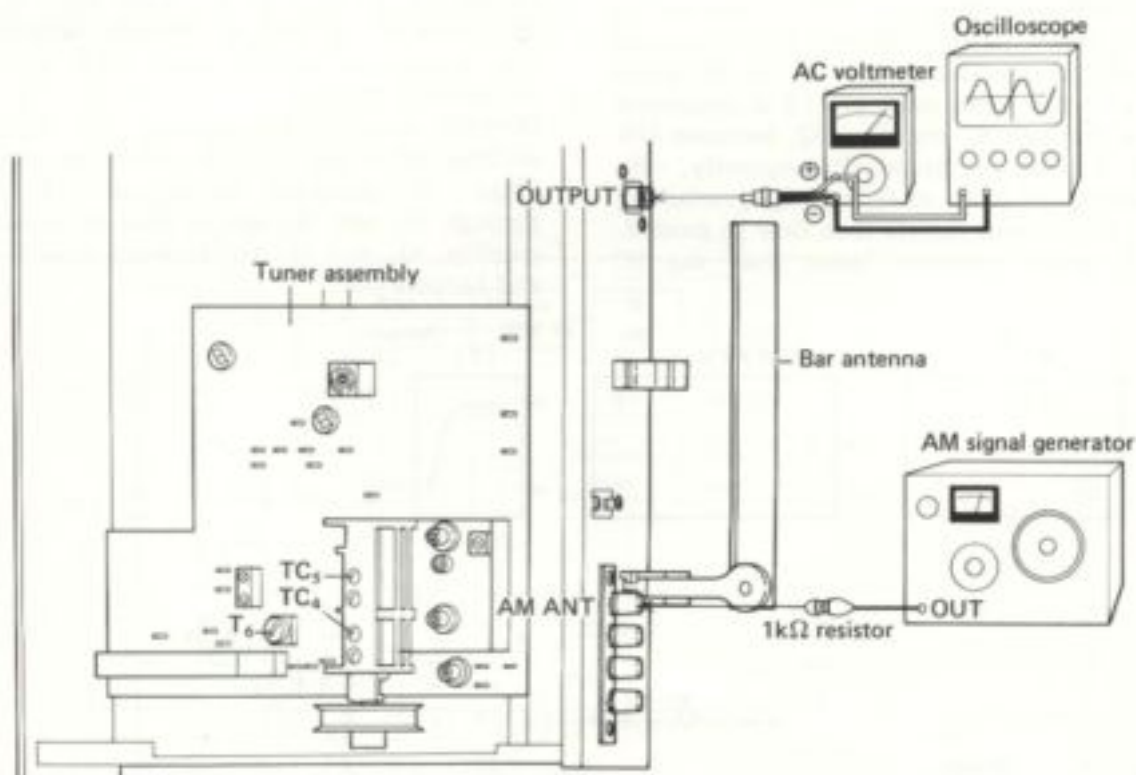

Fig. 6 Connection Diagram for AM Tracking Adjustment

8.2 FM SECTION

1. FM Tracking

1. Switch positions on the TX-6500II:

FUNCTION FM MONO
 POWER ON

2. Connection of instruments:

FM Signal Generator (FM SG) Connect to FM ANTENNA terminals through 300 Ω dummy antenna.

AC Voltmeter }
 Distortion meter } Connect in parallel to OUTPUT terminal.
 Oscilloscope }

3. Set FM SG to 100% modulation (± 75 kHz deviation) at 400Hz and 100dB output.
 4. Adjust T_5 (lower core) so that AM/FM meter points to the center.
 5. Tune FM SG and TX-6500II to dial readings of 90MHz.
 6. Set FM SG output to 8 ~ 10dB and adjust T_3 , T_1 and T_2 to maximize audio frequency output level.
 7. Tune FM SG and TX-6500II to dial readings of 106MHz.
 8. Set FM SG output to 8 ~ 10dB and adjust TC_3 , TC_1 and TC_2 to maximize audio frequency output level.
 • Repeat steps 4 through 8 so that output is maximized when the dial indicates the given frequencies.
 9. Tune FM SG and TX-6500II to dial readings of 90MHz and adjust T_4 to maximize audio frequency output level when FM SG output is 8 ~ 10dB.
 10. Detune TX-6500II so that only noise is received.
 11. Adjust T_5 (lower core) so that AM/FM meter points to the center.
 12. Tune FM SG and TX-6500II to dial readings of 98MHz. Fine tune TX-6500II, observing AM/FM meter.
 13. Set FM SG output to 60dB and adjust T_5 (upper core) to minimize distortion.
 • Repeat steps 11 through 13 so that the distortion in audio frequency is minimized.

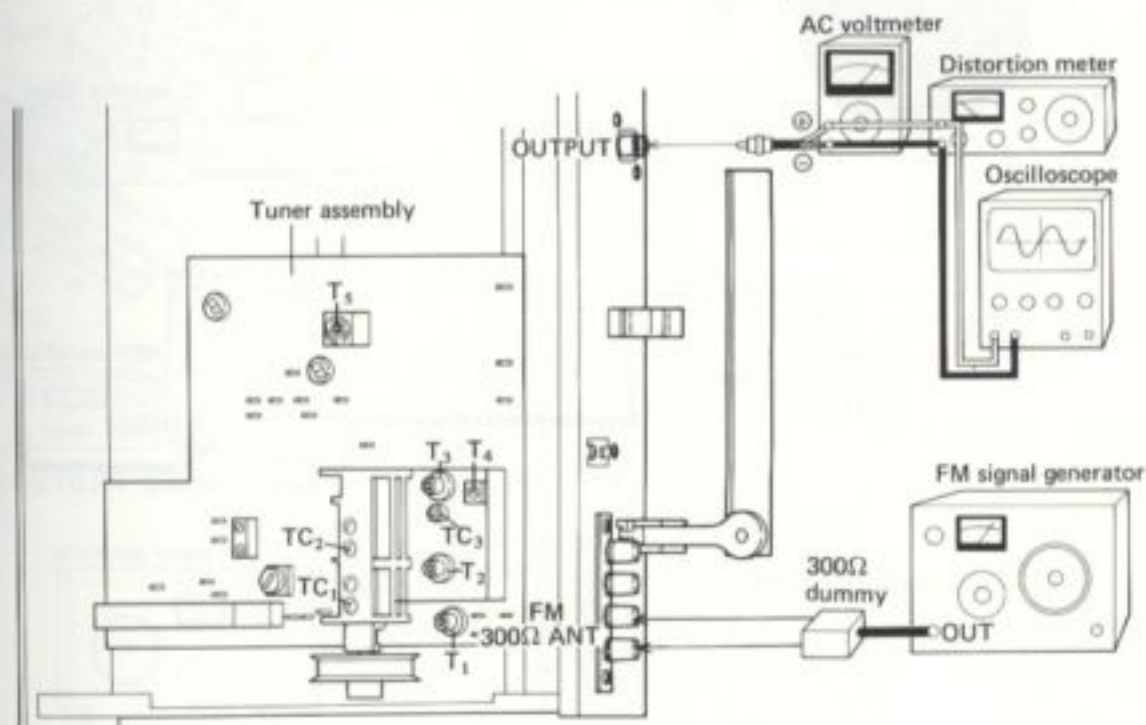

Fig. 7 Connection Diagram for FM Tracking Adjustment

2. FM MPX Adjustment

- The TX-6500II incorporates a PLL demodulator circuit. This adjustment should only be made when MPX IC has been replaced.
- This adjustment should be made after completion of FM tracking adjustment.
- For this purpose, the oscilloscope should have high vertical sensitivity (approximately 10mV/cm).

1. Switch positions on the TX-6500II:

FUNCTION FM AUTO
POWER ON

2. Connection of instruments:

FM Signal Generator (FM SG) Connect to FM ANTENNA terminals through 300Ω dummy antenna.

MPX Signal Generator (MPX SG) Connect to FM SG's external modulator terminals.

Oscilloscope Connect horizontal input to MPX SG's PILOT OUT terminals and vertical input to No. 22 terminal of tuner assembly.

Distortion meter and AC voltmeter .. Connect to R channel OUTPUT terminal.

3. Tune FM SG and TX-6500II to dial readings of 98MHz.

4. Set MPX SG to $\pm 67.5\text{kHz}$ deviation at 1kHz for left and right channels and FM SG output to 60dB.

5. Produce a Lissajous pattern on oscilloscope and adjust VR₂ to make the pattern still (See Fig. 8).

6. Set MPX SG to $\pm 67.5\text{kHz}$ deviation at 1kHz for left channel and to $\pm 7.5\text{kHz}$ deviation for 19kHz pilot signal. Set FM SG output to 60dB.

7. Adjust VR₁ to minimize audio frequency output level.

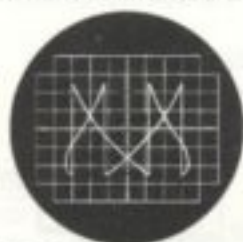

Fig. 8 Lissajous pattern

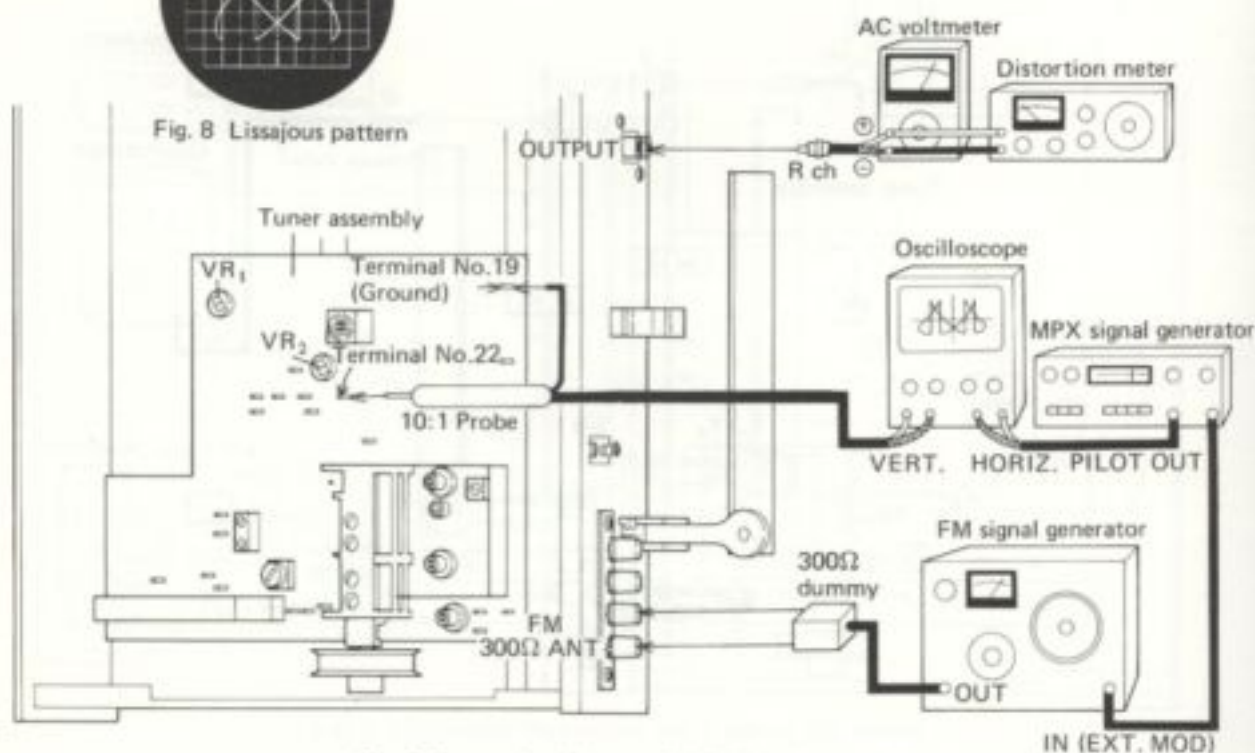
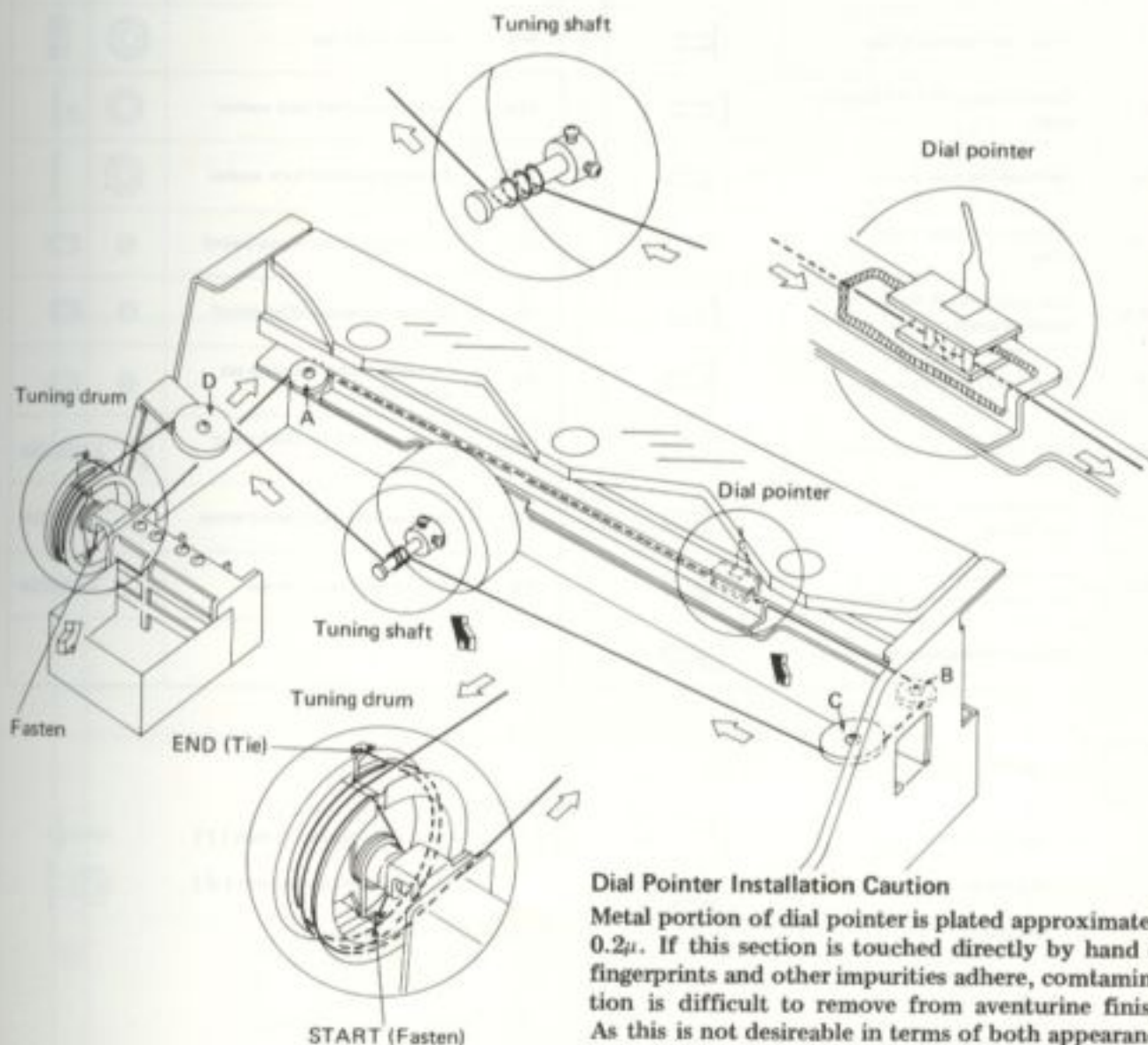

Fig. 9 Connection Diagram for MPX Adjustment

9. DIAL CORD STRINGING

1. Remove the top cover and front panel assembly.
2. Set the tuning capacitor to maximum capacitance.
3. Fasten one end of the cord to the protrusion on the tuning drum and lead it round pulleys A, B and C.
4. Wind the cord 3 turns round the tuning shaft and run it round pulley D.
5. Wind the cord 2 turns round the tuning drum and tie the end to the spring while tensioning the spring slightly.
6. Confirm that dial striging moves smoothly. If so, cut the unnecessary portion of string.
7. Turn the tuning knob fully counterclockwise and fix dial pointer to cord so that it indicates low end on the dial scale.









Dial Pointer Installation Caution

Metal portion of dial pointer is plated approximately 0.2μ . If this section is touched directly by hand or fingerprints and other impurities adhere, contamination is difficult to remove from aventurine finish. As this is not desirable in terms of both appearance and anticorrosion, use extreme care not to touch the metal section when handling the dial pointer.

10. EXPLODED VIEW

NOMENCLATURE OF SCREWS, WASHERS AND NUTS

The following symbols stand for screws, washers and nuts as shown in exploded view.

Symbol	Description	Shape
RT	Brazier head tapping screw	
PT	Pan head tapping screw	
BT	Binding head tapping screw	
CT	Countersunk head tapping screw	
TT	Truss head tapping screw	
OCT	Oval countersunk head tapping screw	
PM	Pan head machine screw	
CM	Countersunk head machine screw	
OCM	Oval countersunk head machine screw	
TM	Truss head machine screw	
BM	Binding head machine screw	
PSA	Pan head screw with spring lock washer	
PSB	Pan head screw with spring lock washer and flat washer	
PSF	Pan head screw with flat washer	

Symbol	Description	Shape
EW	E type washer	
FW	Flat washer	
SW	Spring lock washer	
N	Nut	
WN	Washer faced nut	
ITW	Internal toothed lock washer	
OTW	Outernal toothed lock washer	
SC	Slotted set screw (Cone point)	
SF	Slotted set screw (Flat point)	
HS	Hexagon socket headless set screw	
OCW	Oval countersunk head wood screw	
CW	Countersunk head wood screw	
RW	Round head wood screw	

EXAMPLE

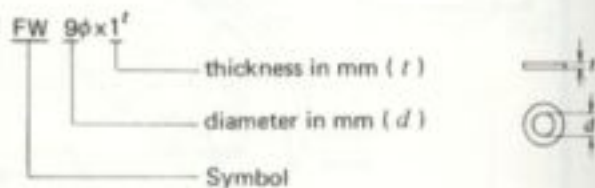
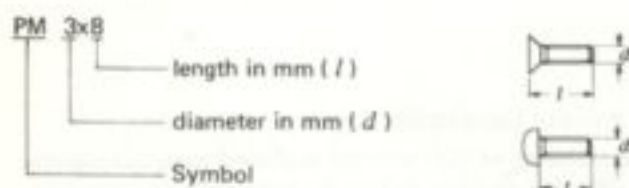

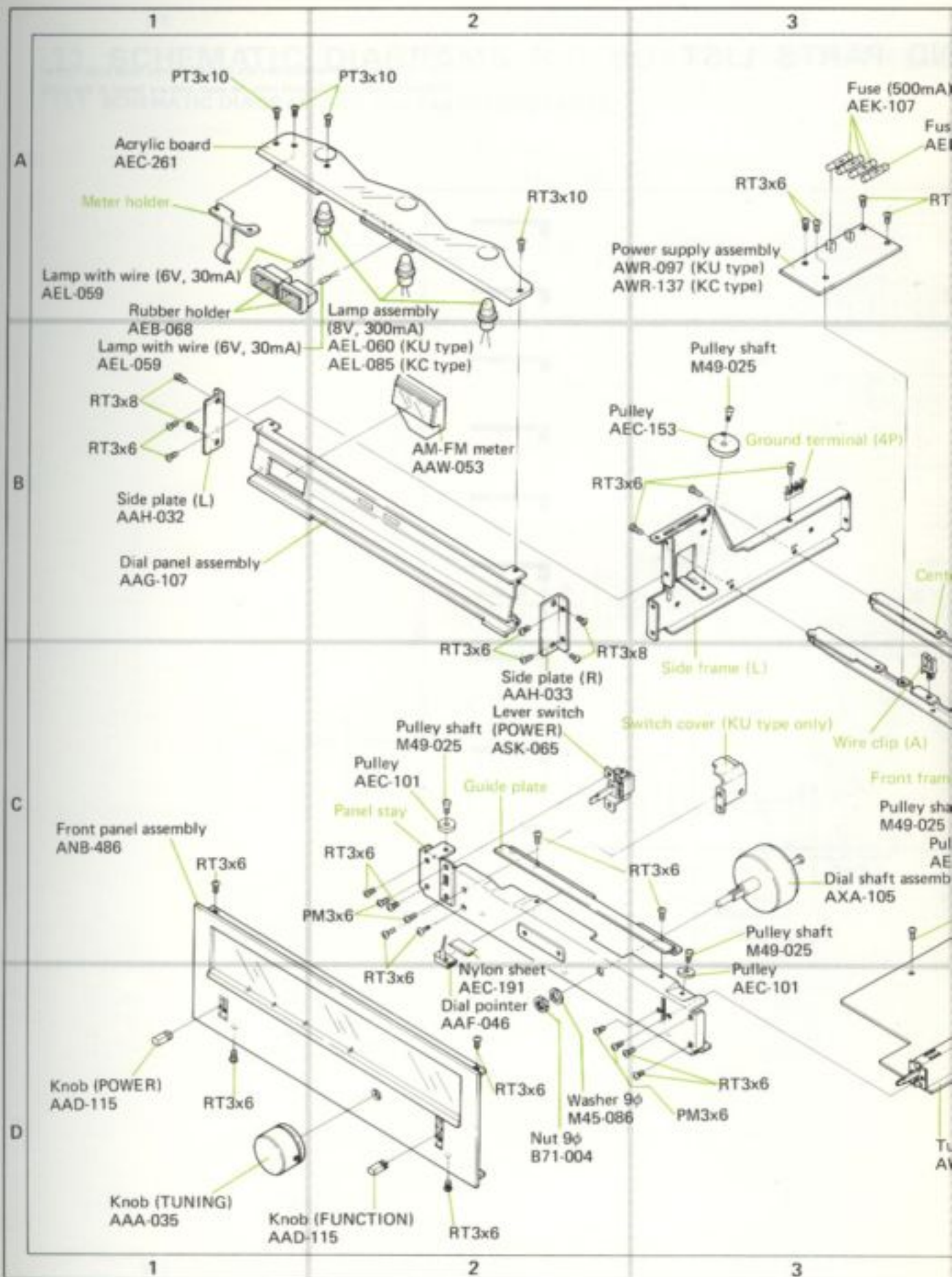

11. SCHEMATIC DIAGRAMS, P.C. BOARD PATTERNS A

11.1 SCHEMATIC DIAGRAM AND MISCELLANEOUS PARTS

A

B

C

D

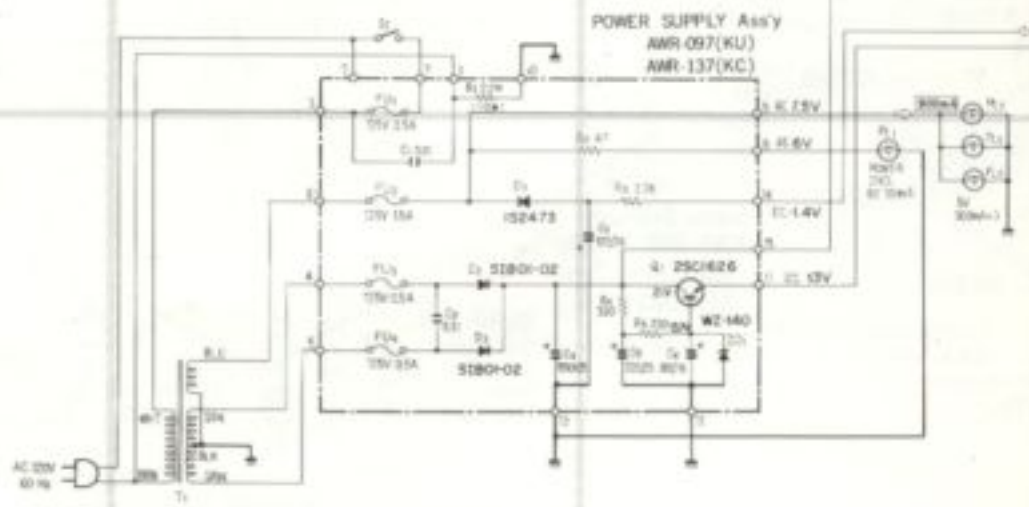
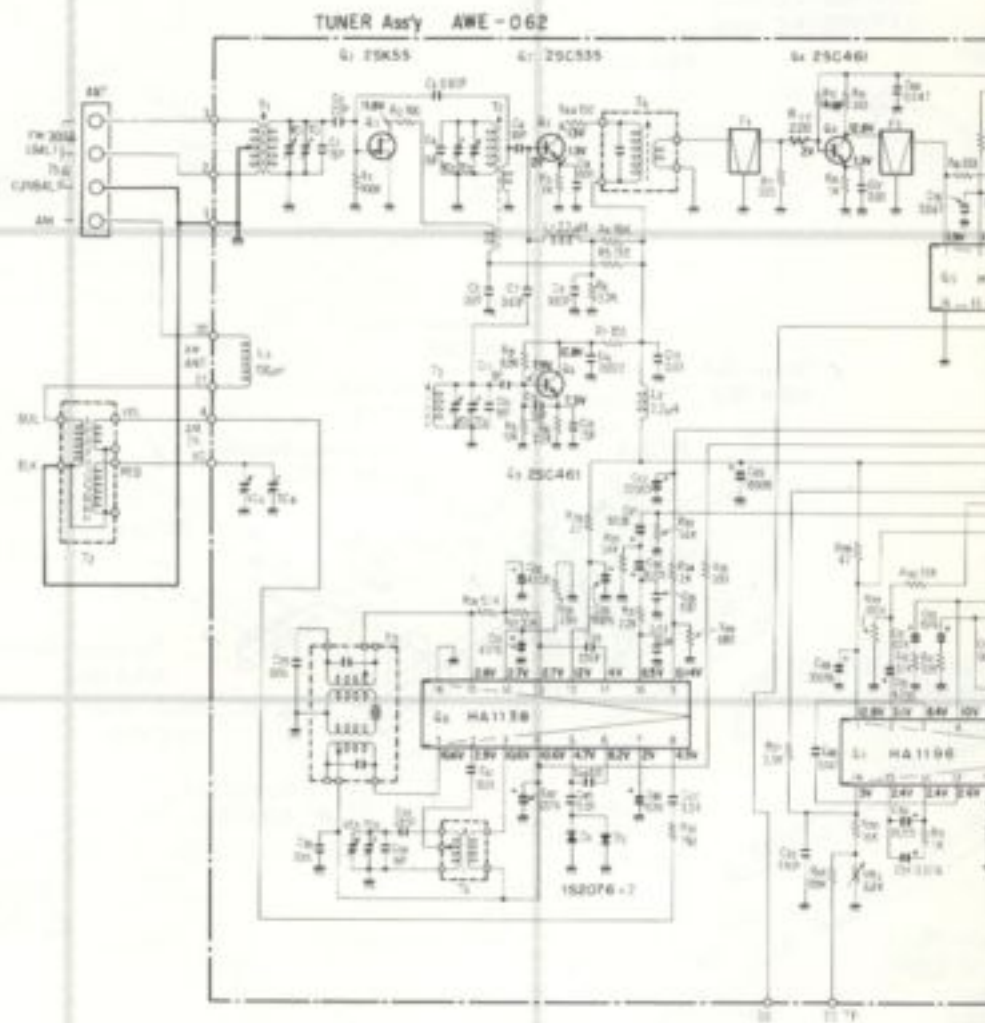

1

2

3

ND PARTS LIST

NOTE:

The indicated semiconductors are representative ones only. Other alternative semiconductors may be used and are listed in the parts list.

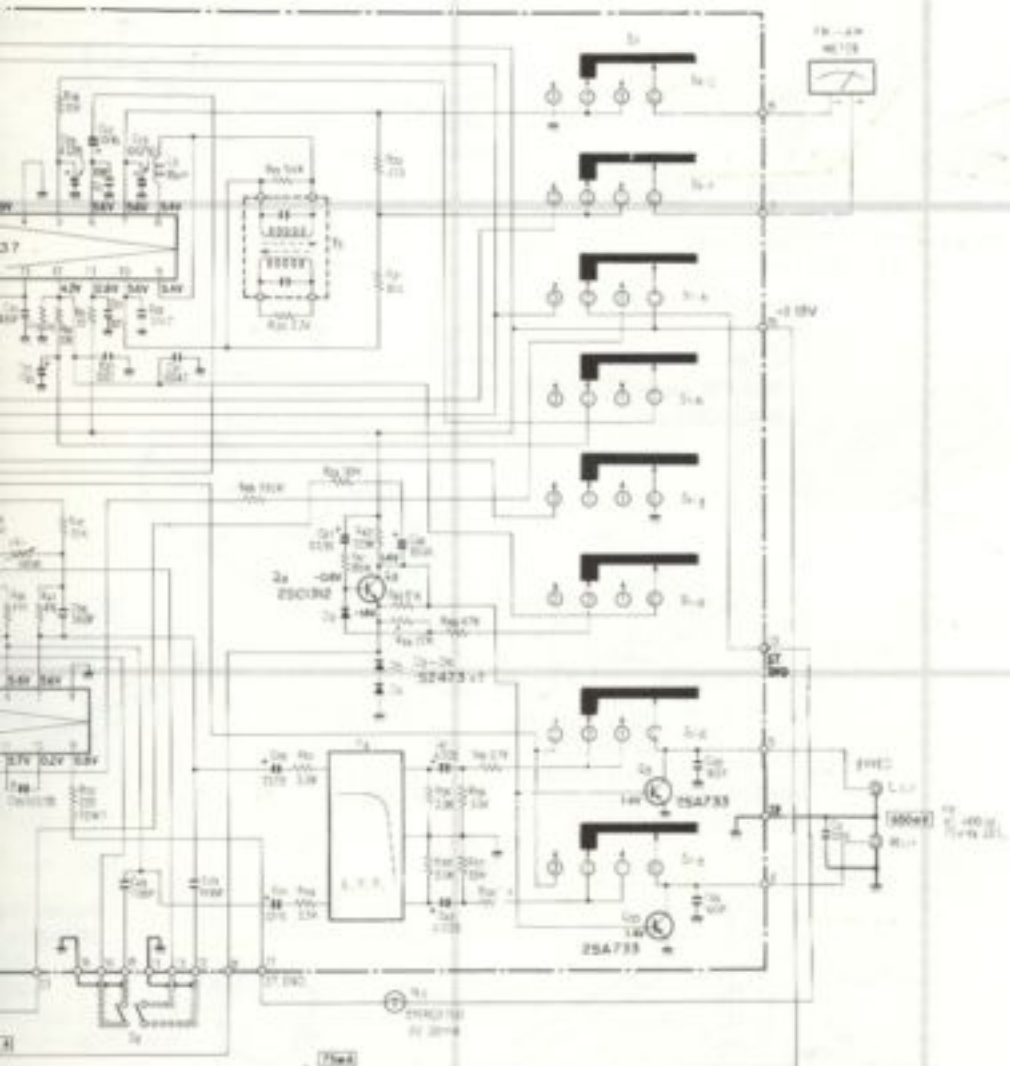

SWITCHES

- 1. PULL UP
- 2. 100 OHM
- 3. 100 OHM
- 4. 100 OHM
- 5. 100 OHM
- 6. 100 OHM
- 7. 100 OHM
- 8. 100 OHM
- 9. 100 OHM
- 10. 100 OHM

⊕ DC CURRENT AT NO INPUT SIGNAL

RESISTORS

25 OHM, 1/4 W, 1% TOLERANCE UNITS
 OTHERWISE 1/2 W, 1% TOL, 100 Ω

CAPACITORS

10 μF 50VDC 50% TOL
 OTHERWISE 1 μF

Miscellaneous Parts List

SWITCHES

Symbol	Description	Part No.
S2	Lever switch (POWER)	ASK-065
S3	Slide switch (DE-EMPHASIS)	ASH-016

TRANSFORMER AND COIL

Symbol	Description	Part No.
T1	Power transformer (KU)	ATT-298
	Power transformer (KC)	ATT-286
T2	Bar antenna	ATB-505

CAPACITOR

Symbol	Description	Part No.
C2	Ceramic 0.04 50V	CKDYF403Z 50

NOTES:

- Capacitors: in μF unless otherwise noted p:pF
- Resistors: in Ω , $\frac{1}{4}W$ unless otherwise noted k:k Ω , M:M Ω

LAMPS AND FUSES

Symbol	Description	Part No.
PL1	Lamp with wire 6V, 30mA	AEL-059
PL2	Lamp assembly 8V, 300mA	AEL-060 (KU) AEL-085 (KC)
PL3	Lamp assembly 8V, 300mA	AEL-060 (KU) AEL-085 (KC)
PL4	Lamp assembly 8V, 300mA	AEL-060 (KU) AEL-085 (KC)
PL5	Lamp with wire 6V, 30mA	AEL-059
FU1	Fuse 500mA (Primary)	AEK-107
FU2	Fuse 1.5A (Secondary)	AEK-104
FU3	Fuse 500mA (Secondary)	AEK-107
FU4	Fuse 500mA (Secondary)	AEK-107

External Appearances of Transistors and ICs

2SK55



2SC535
2SC461



HA1196
HA1137
HA1138

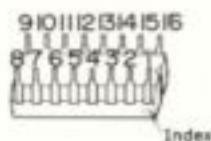

2SC1312



2SA733



2SC1626



Circuit Diagrams of ICs

HA1137 (FM IF IC)

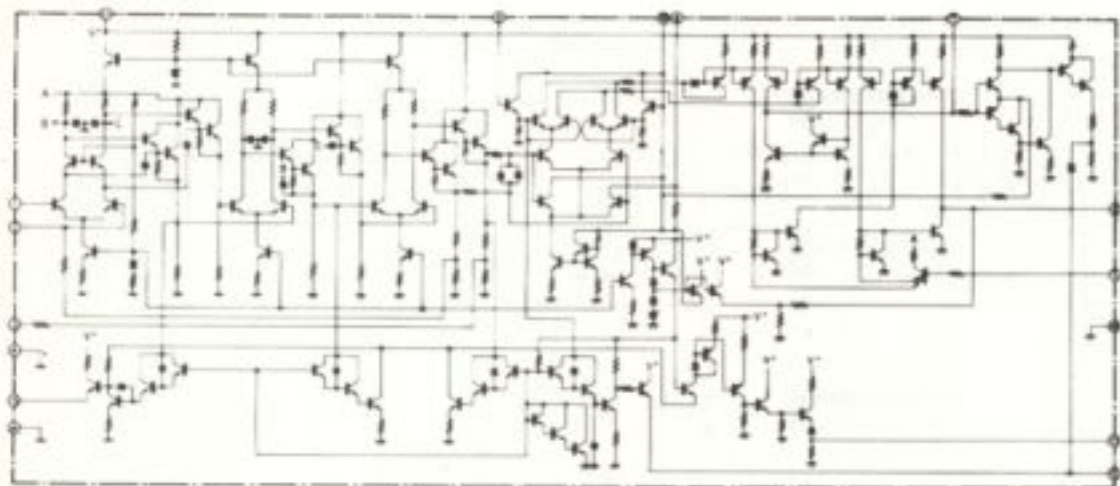

HA1138 (AM IC)

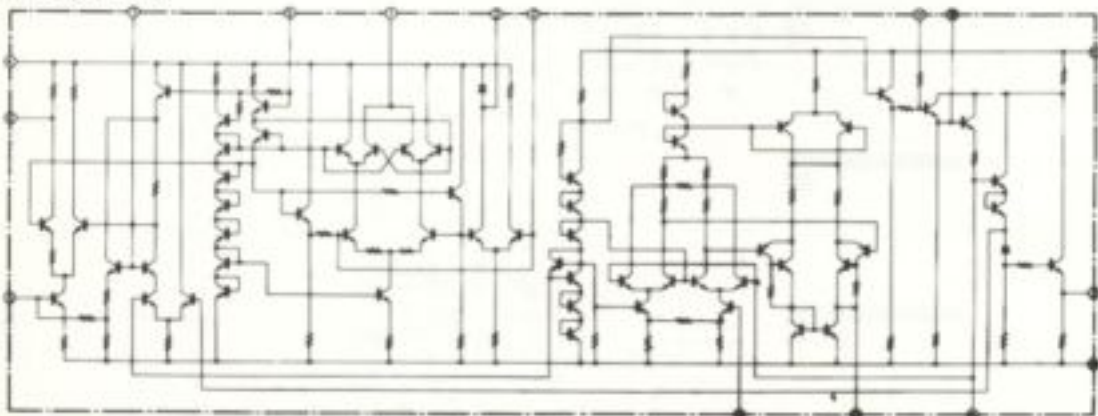

HA1196 (MPX IC)

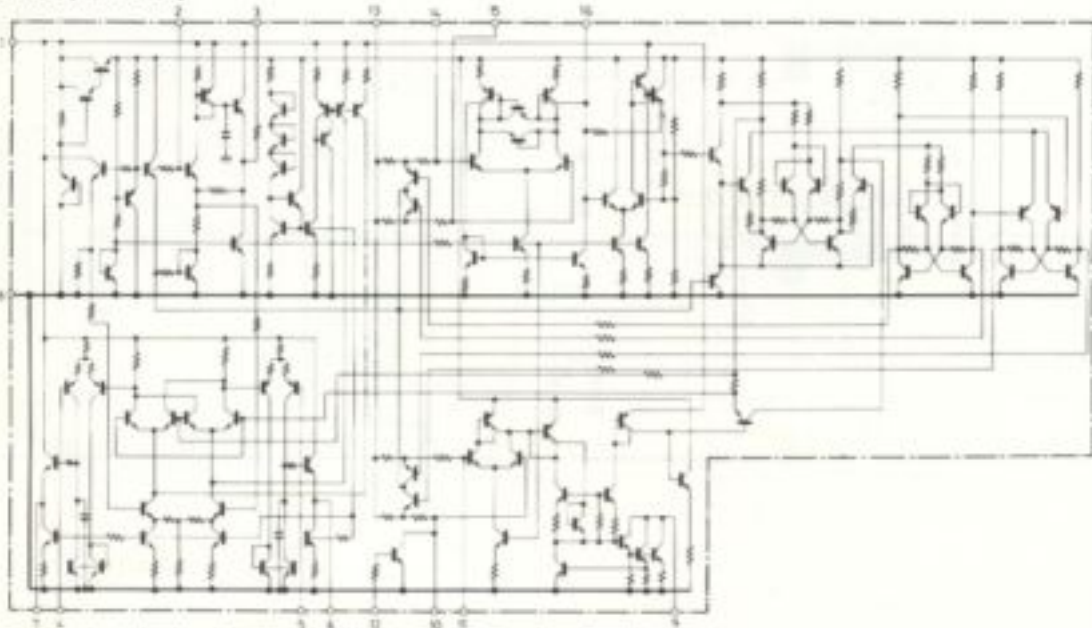

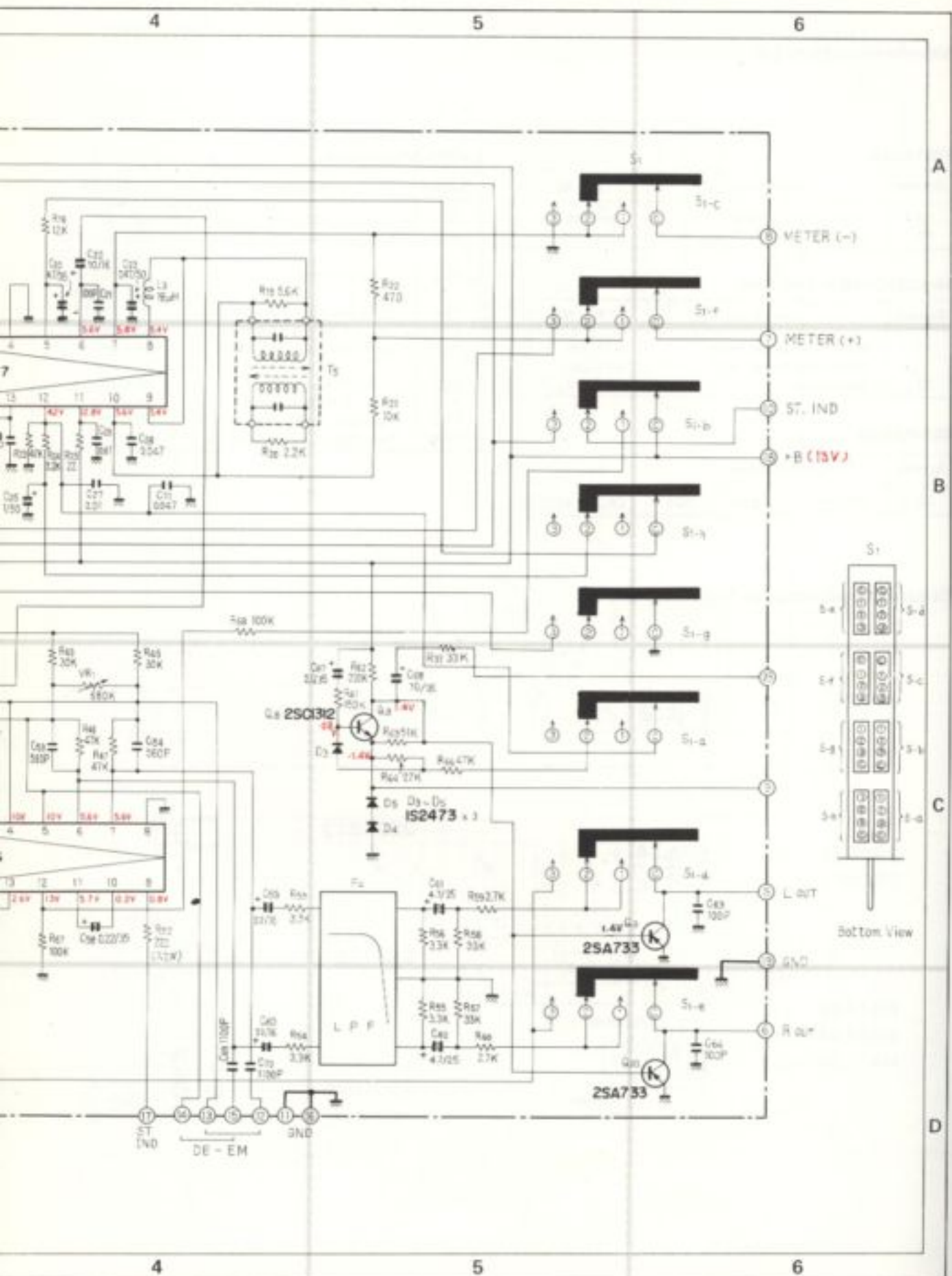

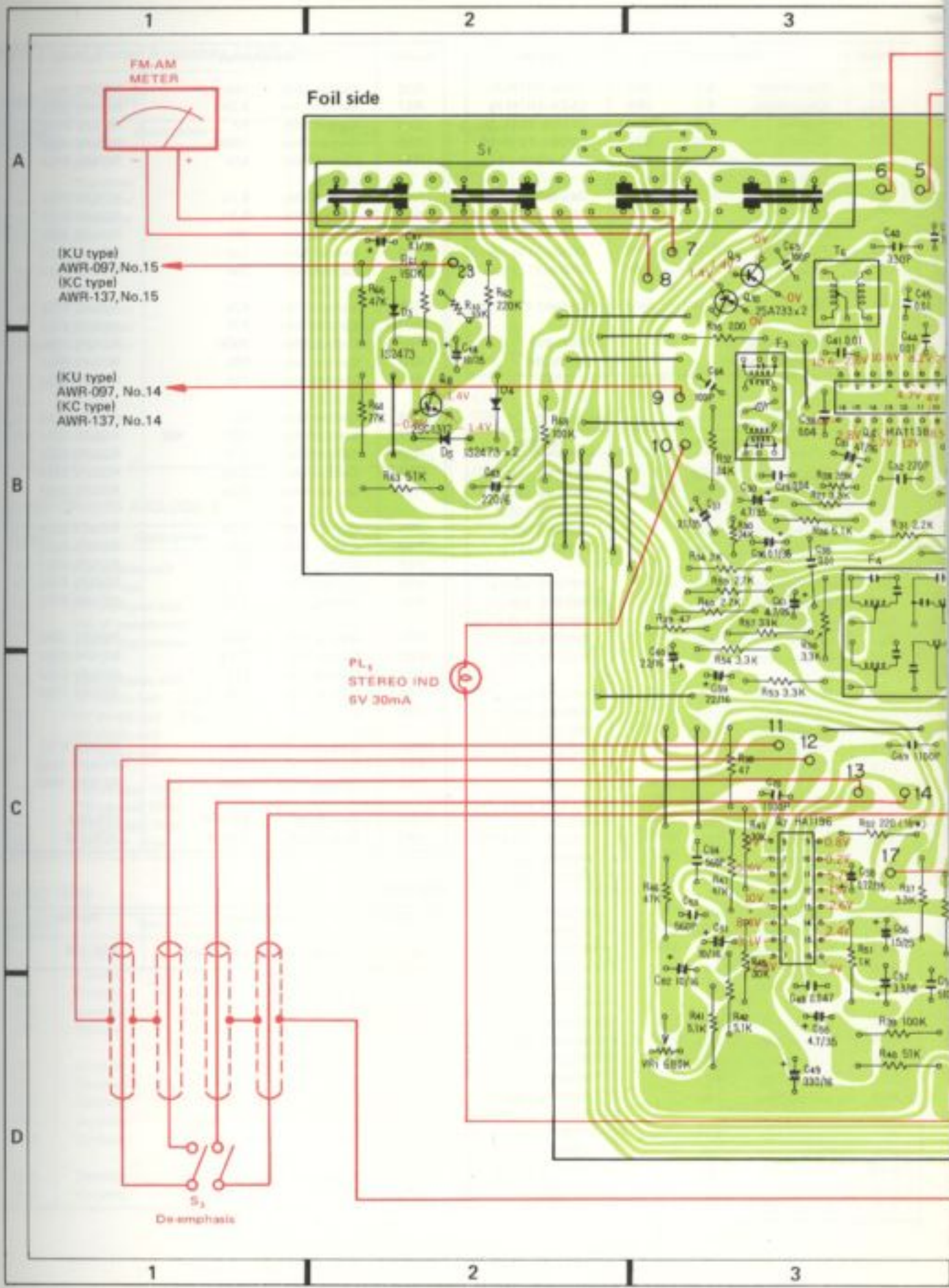

(KU type)
AWR-097, No.15
(KC type)
AWR-137, No.15

(KU type)
AWR-097, No.14
(KC type)
AWR-137, No.14

PL₁
STEREO IND
6V 30mA

S₃
De-emphasis

Parts List of Tuner Assembly (AWE-062)

SEMICONDUCTORS

Symbol	Description	Part No.
Q1	FET	2SK55-D
Q2	Transistor	2SC535-A
Q3	Transistor	2SC461-B
Q4	Transistor	2SC461-B
Q5	IC	HA1137
Q6	IC	HA1138
Q7	IC	HA1196
Q8	Transistor	2SC1312-G or F
Q9	Transistor	2SA733-Q or R
Q10	Transistor	2SA733-Q or R
D1	Diode	1S2076
D2	Diode	1S2076
D3	Diode	1S2473
D4	Diode	1S2473
D5	Diode	1S2473

TRANSFORMERS AND COILS

Symbol	Description	Part No.
T1	FM antenna coil	ATC-030
T2	FM RF coil	ATC-024
T3	FM oscillator coil	ATC-031
T4	FM IF transformer	ATE-008
T5	FM IF transformer	T73-035
T6	AM oscillator coil	ATB-039
L1	RF choke coil 2.2 μ H	T24-028
L2	RF choke coil 2.2 μ H	T24-028
L3	RF choke coil	ATH-015
L4	RF choke coil	T24-030
F1	FM ceramic filter	ATF-013
F2	FM ceramic filter	ATF-013
F3	AM ceramic filter	ATF-027
F4	MPX L.P. filter	ATF-033

CAPACITORS

Symbol	Description	Part No.
C1	Ceramic 15p 50V	CCDTH 150K 50
C2	Ceramic 22p 50V	CCDSL 220K 50
C3	Ceramic 0.82p 500V	CGB R82K 500
C4	Ceramic 18p 50V	CCDTH 180K 50
C5	Ceramic 0.01 50V	CKDYF 103Z 50
C6	Ceramic 10p 50V	CCDSL 100F 50
C7	Ceramic 0.47p 500V	CGB R47K 500
C8	Ceramic 0.01 50V	CKDYF 103Z 50
C9	Ceramic 100p 50V	CCDSL 101K 50
C10	Ceramic 18p 50V	CCDRH 180K 50
C11	Ceramic 8p 50V	CCDSH 080F 50
C12	Ceramic 33p 50V	CCDCH 330K 50

Symbol	Description	Part No.
C13	Ceramic 15p 50V	CCDCH 150K 50
C14	Ceramic 0.022 50V	CKDYF 223K 50
C15	Ceramic 0.01 50V	CKDYF 103Z 50
C16
C17	Ceramic 0.01 50V	CKDYF 103Z 50
C18	Ceramic 0.047 25V	CKDBC 473Z 25
C19	Ceramic 0.047 25V	CKDBC 473Z 25
C20	Electrolytic 4.7 35V	CEA 4R7P 35
C21	Ceramic 100p 50V	CCDSL 101K 50
C22	Electrolytic 10 16V	CEA 100P 16
C23	Electrolytic 0.47 50V	CEA R47P 50
C24	Ceramic 100p 50V	CCDSL 101K 50
C25	Electrolytic 1 50V	CEA 010P 50
C26	Ceramic 0.01 50V	CKDYF 103Z 50
C27	Ceramic 0.01 50V	CKDYF 103Z 50
C28	Ceramic 0.047 25V	CKDBC 473Z 25
C29	Ceramic 0.04 50V	CKDYF 403Z 50
C30	Electrolytic 4.7 35V	CEA 4R7P 35
C31	Electrolytic 47 16V	CEA 470P 16
C32	Ceramic 220p 50V	CCDSL 221K 50
C33	Electrolytic 100 16V	CEA 101P 16
C34	Ceramic 0.01 50V	CKDYB 103K 50
C35	Ceramic 0.01 50V	CKDYF 103Z 50
C36	Electrolytic 0.1 35V	CSZA 0R1M 35
C37	Electrolytic 0.1 35V	CSZA 0R1M 35
C38	Ceramic 0.04 50V	CKDYF 403Z 50
C39	Ceramic 8p 50V	CCDXL 080F 50
C40	Polystyrene 330p 50V	QOSA 331J 50
C41	Ceramic 0.01 50V	CKDYF 103Z 50
C42	Electrolytic 22 16V	CEA 220P 16
C43	Electrolytic 220 6V	CEA 221P 6
C44	Ceramic 0.01 50V	CKDYF 103Z 50
C45	Ceramic 0.01 50V	CKDYF 103Z 50
C46	Electrolytic 10 16V	CEA 100P 16
C47	Ceramic 0.04 50V	CKDYF 403Z 50
C48	Myjar 0.047 50V	QOMA 473K 50
C49	Electrolytic 330 16V	CEA 331P 16
C50	Electrolytic 4.7 35V	CEA 4R7P 35
C51	Electrolytic 10 16V	CEA 100P 16
C52	Electrolytic 10 16V	CEA 100P 16
C53	Polystyrene 560p 50V	QOSA 561G 50
C54	Polystyrene 560p 50V	QOSA 561G 50
C55	Polystyrene 510p 50V	QOSH 511J 50
C56	Electrolytic 1.5 25V	CSZA 1R5M 25
C57	Electrolytic 3.3 16V	CSZA 3R3M 16
C58	Electrolytic 0.22 35V	CSZA R22M 35
C59	Electrolytic 22 16V	CEA 220P 16
C60	Electrolytic 22 16V	CEA 220P 16

Symbol	Description	Part No.
C61	Electrolytic 4.7 25V	CSZA 4R7M25
C62	Electrolytic 4.7 25V	CSZA 4R7M25
C63	Ceramic 100p 50V	CCDSL 101K 50
C64	Ceramic 100p 50V	CCDSL 101K 50
C65	Electrolytic 100 16V	CEA 101P 16
C66	Ceramic 0.047 25V	CKDBC 473Z 25
C67	Electrolytic 0.1 35V	CSZA 0R1M 35
C68	Electrolytic 10 35V	CEA 100P 35
C69	Polystyrene 0.0011 50V	CQSA 112J 50
C70	Polystyrene 0.0011 50V	CQSA 112J 50
C71	Ceramic 0.047 25V	CKDBC 473Z 25
VC	Tuning capacitor	ACK-017
TC3	Ceramic trimmer	ACM-006

RESISTORS

Symbol	Description	Part No.
R1	Carbon film 100k	RD%VS 104J
R2	Carbon film 100	RD%VS 101J
R3	Carbon film 1k	RD%VS 102J
R4	Carbon film 18k	RD%VS 183J
R5	Carbon film 150	RD%PS 151J
R6	Carbon film 3.3k	RD%VS 332J
R7	Carbon film 100	RD%PS 101J
R8	Carbon film 12k	RD%VS 123J
R9	Carbon film 6.8k	RD%VS 682J
R10	Carbon film 2.2k	RD%VS 222J
R11	Carbon film 330	RD%PS 331J
R12	Carbon film 220	RD%PS 221J
R13	Carbon film 4.3k	RD%PS 432J
R14	Carbon film 1k	RD%PS 102J
R15	Carbon film 330	RD%PS 331J
R16	Carbon film 330	RD%PS 331J
R17	Carbon film 560k	RD%PS 564J
R18	Carbon film 12k	RD%PS 123J
R19	Carbon film 6.8k	RD%PS 562J
R20	Carbon film 2.2k	RD%PS 222J
R21	Carbon film 10k	RD%PS 103J
R22	Carbon film 470	RD%PS 471J
R23	Carbon film 47k	RD%VS 473J
R24	Carbon film 2.2k	RD%PS 222J
R25	Carbon film 22	RD%PS 220J
R26	Carbon film 5.1k	RD%PS 512J
R27	Carbon film 3.3k	RD%PS 332J
R28	Carbon film 39k	RD%VS 393J
R29	Carbon film 47	RD%VS 470J
R30	Carbon film 24k	RD%VS 243J
R31	Carbon film 2.2k	RD%PS 222J
R32	Carbon film 24k	RD%PS 243J
R33	Carbon film 33k	RD%VS 333J
R34	Carbon film 2k	RD%PS 202J
R35	Carbon film 200	RD%PS 201J

Symbol	Description	Part No.
R36	Carbon film 150	RD%PS 151J
R37	Carbon film 3.3k	RD%PS 332J
R38	Carbon film 47	RD%PS 470J
R39	Carbon film 100k	RD%PS 104J
R40	Carbon film 51k	RD%PS 513J
R41	Carbon film 5.1k	RD%PS 512J
R42	Carbon film 5.1k	RD%PS 512J
R43	Carbon film 30k	RD%PS 303J
R44	Carbon film 100	RD%VS 101J
R45	Carbon film 30k	RD%PS 303J
R46	Carbon film 47k	RD%PS 473J
R47	Carbon film 47k	RD%PS 473J
R48	Carbon film 100k	RD%PS 104J
R49	Carbon film 680	RD%PS 681J
R50	Carbon film 16k	RD%PS 163J
R51	Carbon film 1k	RD%PS 102J
R52	Carbon film 220	RD%PS 221J
R53	Carbon film 3.3k	RD%PS 332J
R54	Carbon film 3.3k	RD%PS 332J
R55	Carbon film 3.3k	RD%PS 332J
R56	Carbon film 3.3k	RD%PS 332J
R57	Carbon film 33k	RD%PS 333J
R58	Carbon film 33k	RD%PS 333J
R59	Carbon film 2.7k	RD%PS 272J
R60	Carbon film 2.7k	RD%PS 272J
R61	Carbon film 150k	RD%PS 154J
R62	Carbon film 220k	RD%PS 224J
R63	Carbon film 51k	RD%PS 513J
R64	Carbon film 27k	RD%PS 273J
R65
R66	Carbon film 47k	RD%PS 473J
R67	Carbon film 100k	RD%PS 104J
R68	Carbon film 100k	RD%PS 104J
VR1	Semi-fixed 680k-B	C92-064
VR2	Semi-fixed 6.8k-B	ACP-055

SWITCH

Symbol	Description	Part No.
S1	Lever switch (FUNCTION)	ASK-104

11.3 POWER SUPPLY ASSEMBLY (AWR-097) KU TYPE

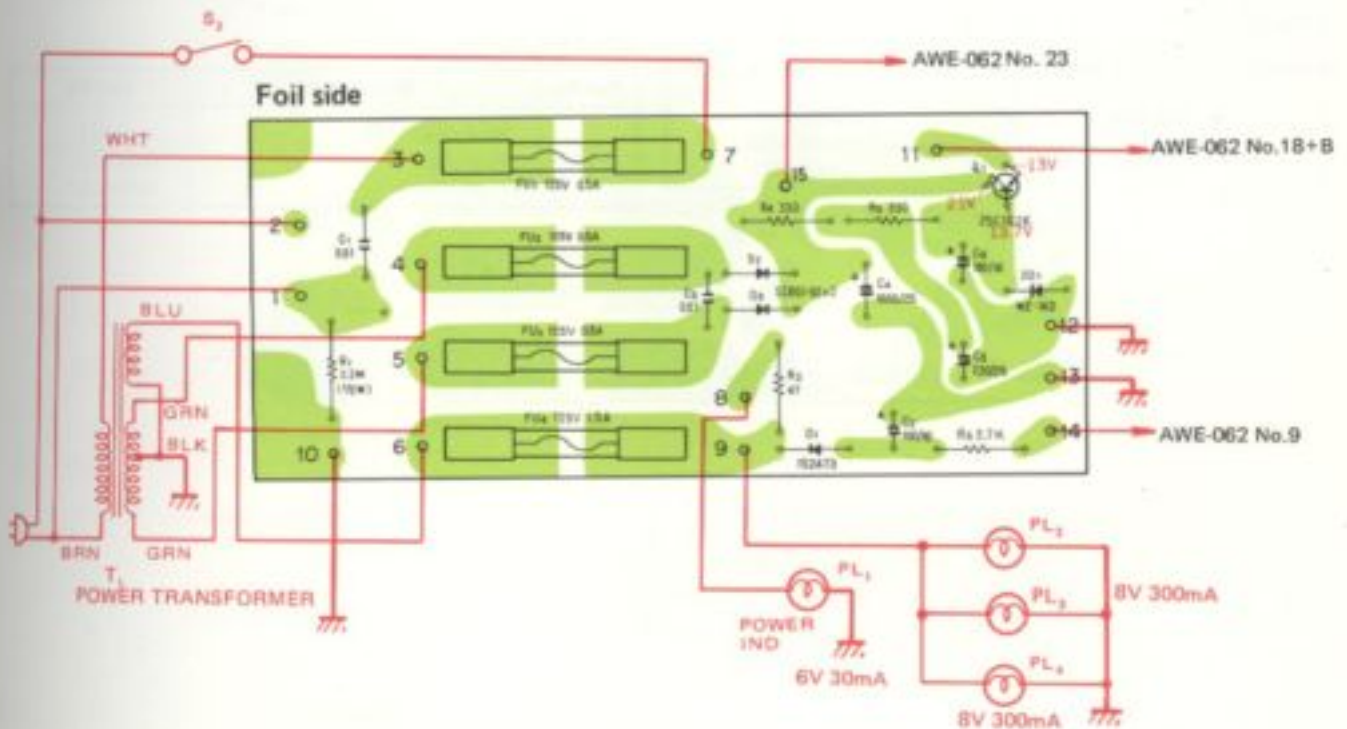
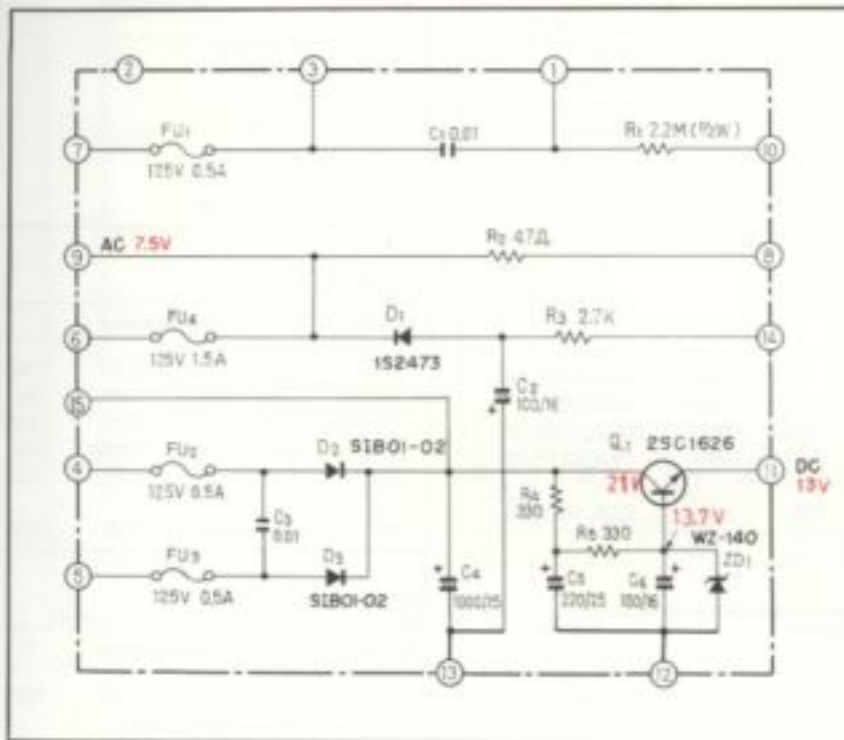

Parts List of Power Supply Assembly (AWR-097)

SEMICONDUCTORS

Symbol	Description	Part No.
Q1	Transistor	2SC1626-O
D1	Diode	1S2473 (1S1555)
D2	Diode	S1801-02
D3	Diode	S1801-02
D4	Zener diode	WZ-140

CAPACITORS

Symbol	Description	Part No.
C1	Ceramic 0.01 125V	ACG-003
C2	Electrolytic 100 16V	CEA 101P 16
C3	Ceramic 0.01 150V	ACG-004
C4	Electrolytic 1000 25V	CEA 102P 25
C5	Electrolytic 220 25V	CEA 221P 25
C6	Electrolytic 100 16V	CEA 101P 16

RESISTORS

Symbol	Description	Part No.
R1	Carbon film 2.2M 1/2W	RD%PS 225J
R2	Carbon film 47	RD%PS 470J
R3	Carbon film 2.7k	RD%PS 272J
R4	Carbon film 330	RD%PS 331J
R5	Carbon film 330	RD%PS 331J

OTHERS

Symbol	Description	Part No.
	Heat sink	ANH-117
	Fuse clip	AKR-013
	Fuse clip	AKR-030

11.4 POWER SUPPLY ASSEMBLY (AWR-137) KC TYPE

SEMICONDUCTORS

Symbol	Description	Part No.
Q1	Transistor	2SC1626-O
D1	Diode	1S2473 (1S1555)
D2	Diode	S1801-02
D3	Diode	S1801-02
D4	Zener diode	WZ-140

CAPACITORS

Symbol	Description	Part No.
C1	Ceramic 0.01 125V	ACG-014
C2	Electrolytic 100 16V	CEA 101P 16
C3	Ceramic 0.01 150V	ACG-004
C4	Electrolytic 1000 25V	CEA 102P 25
C5	Electrolytic 220 25V	CEA 221P 25
C6	Electrolytic 100 16V	CEA 101P 16

RESISTORS

Symbol	Description	Part No.
R1	Carbon film 2.2M 1/2W	RD%PS 225J
R2	Carbon film 47	RD%PS 470J
R3	Carbon film 2.7k	RD%PS 272J
R4	Carbon film 330	RD%PS 331J
R5	Carbon film 330	RD%PS 331J

OTHERS

Symbol	Description	Part No.
	Heat sink	ANH-117
	Fuse clip	AKR-013
	Fuse clip	AKR-030

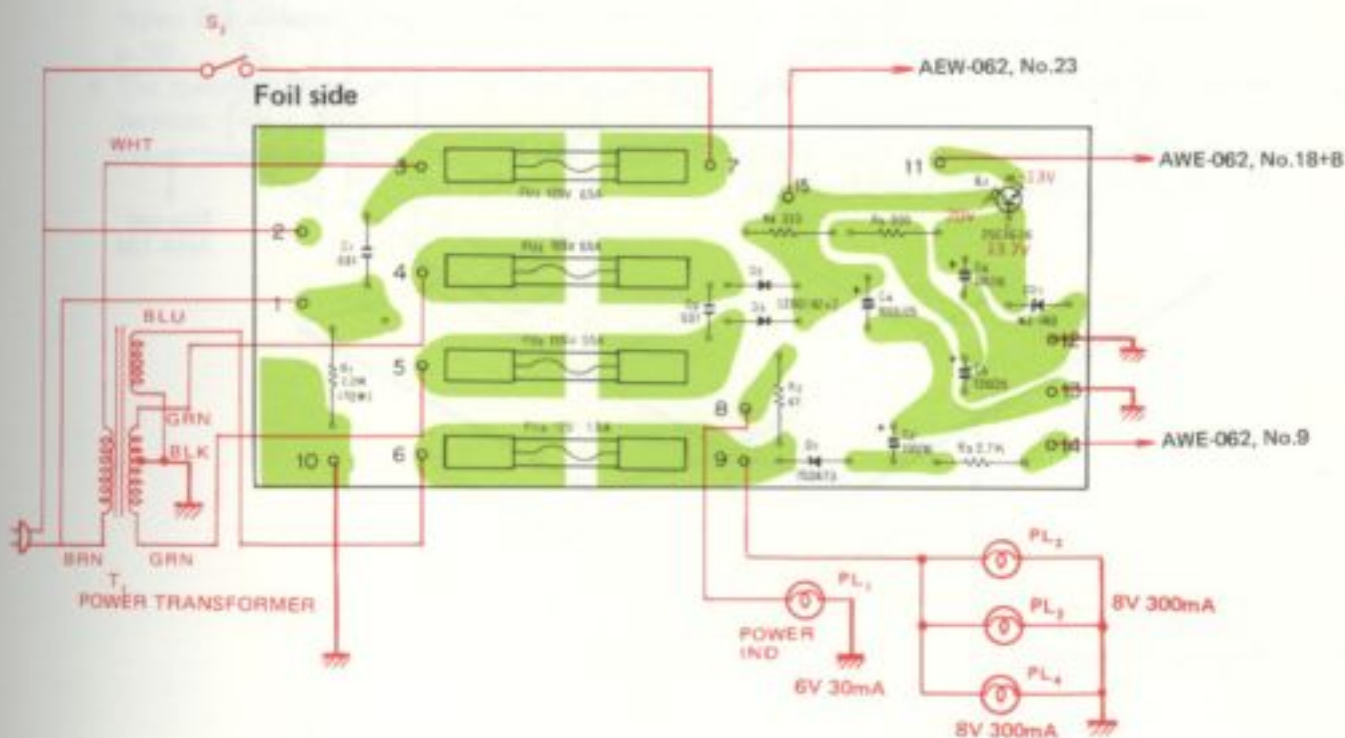
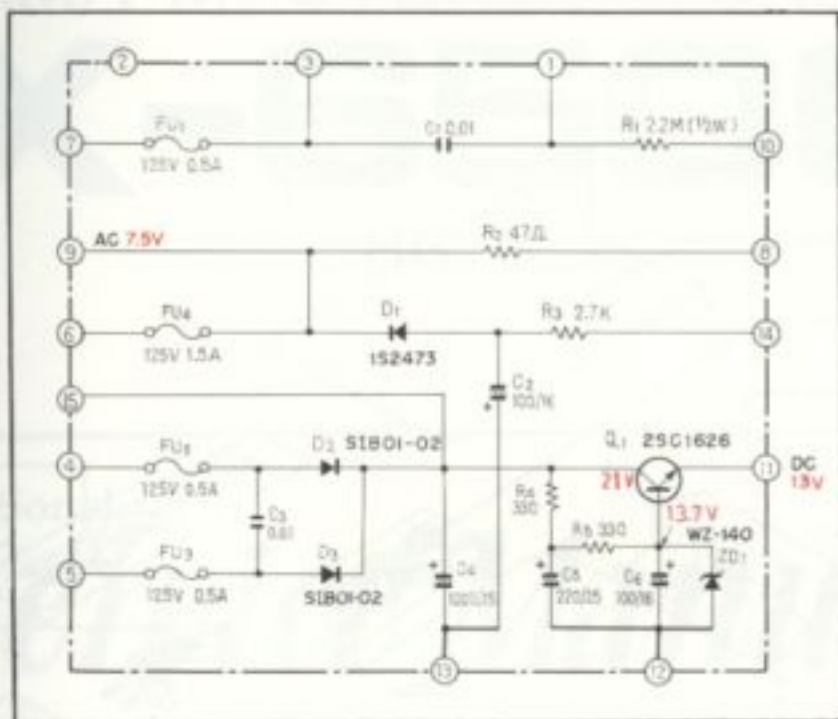

12. PACKING

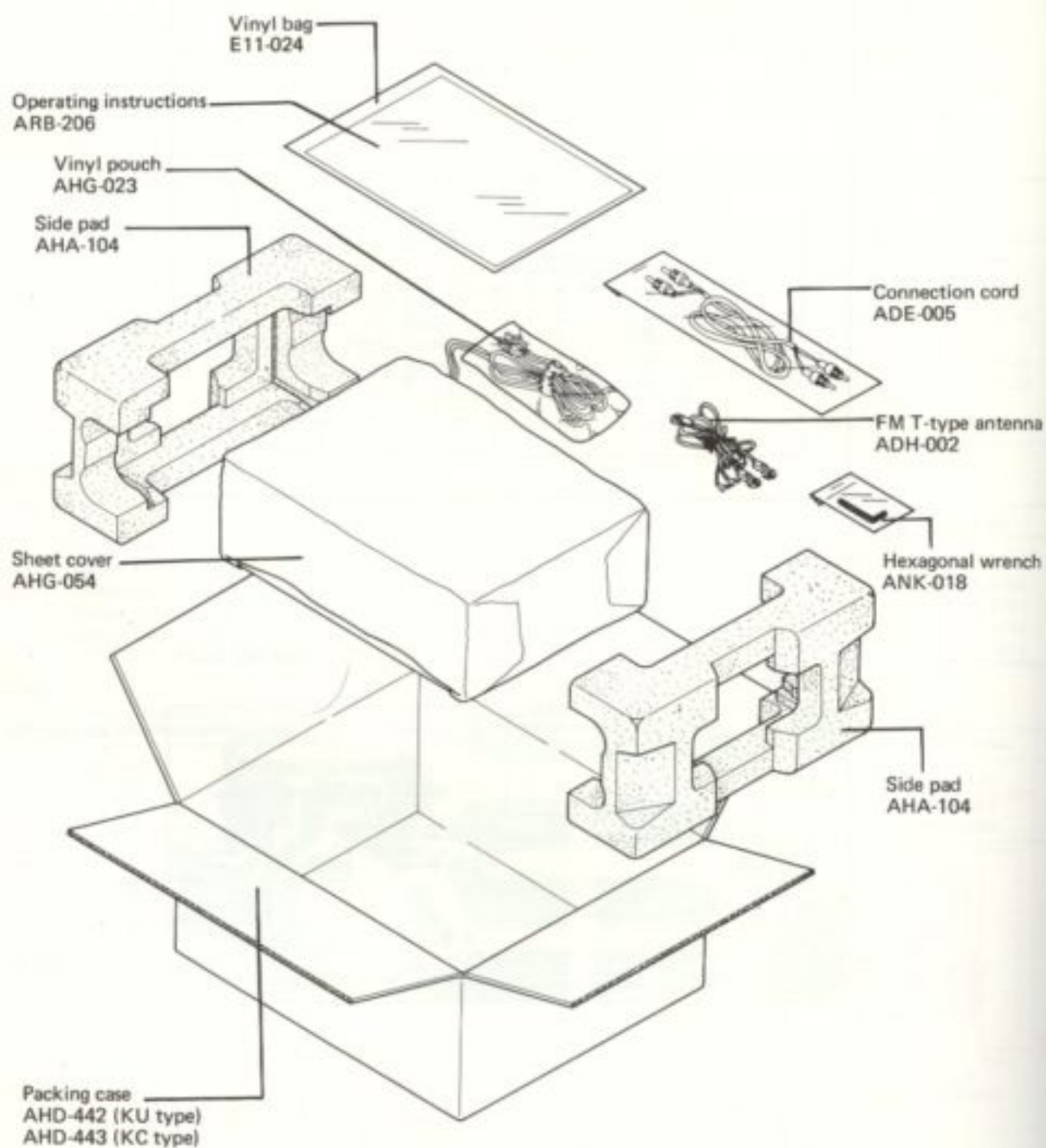

AM/FM STEREO TUNER

TX-6500II

HG, S

Additional

Service Manual

NOTES:

- This leaflet provides the description of the parts applies only to the TX-6500II/S and HG types. For detailed please refer to the service manual of TX-6500II /KU and KC types (p.5 ~ p.36).
- The specifications for "S" and "HG" types are same as KU and KC types except for following sections.

Power Requirements 110V, 120V, 220V and 240V (Switchable) 50-60Hz S type
220V and 240V (Switchable) 50Hz HG type

1. S TYPE

1.1 SCHEMATIC DIAGRAM AND MISCELLANEOUS PARTS

NOTES:

- Capacitors: in μF unless otherwise noted p:pF
- Resistors: in Ω , $\frac{1}{4}W$ unless otherwise noted k:k Ω , M:M Ω

Miscellaneous Parts List

SWITCHES

Symbol	Description	Part No.
S2	Lever switch (POWER)	ASK-095
S4	Plug in selector (Line voltage selector)	AKR-031

TRANSFORMER AND COIL

Symbol	Description	Part No.
T1	Power transformer	ATT-354
T2	Bar antenna	ATB-505

CAPACITORS

Symbol	Description	Part No.
C1	Ceramic 0.01 250V	ACG-001
C2	Ceramic 0.04 50V	CKDYF 403Z 50
C3	Ceramic 0.01 250V	ACG-001

LAMPS AND FUSE

Symbol	Description	Part No.
PL1	Lamp with wire 6V, 30mA	AEL-059
PL2	Lamp assembly 8V, 300mA	AEL-085
PL3	Lamp assembly 8V, 300mA	AEL-085
PL4	Lamp assembly 8V, 300mA	AEL-085
PL5	Lamp with wire 6V, 30mA	AEL-059
FU1	Fuse 500mA (Primary)	AEK-107

4

5

6

NOTE:

The indicated semiconductors are representative ones only. Other alternative semiconductors may be used and are listed in the parts list.

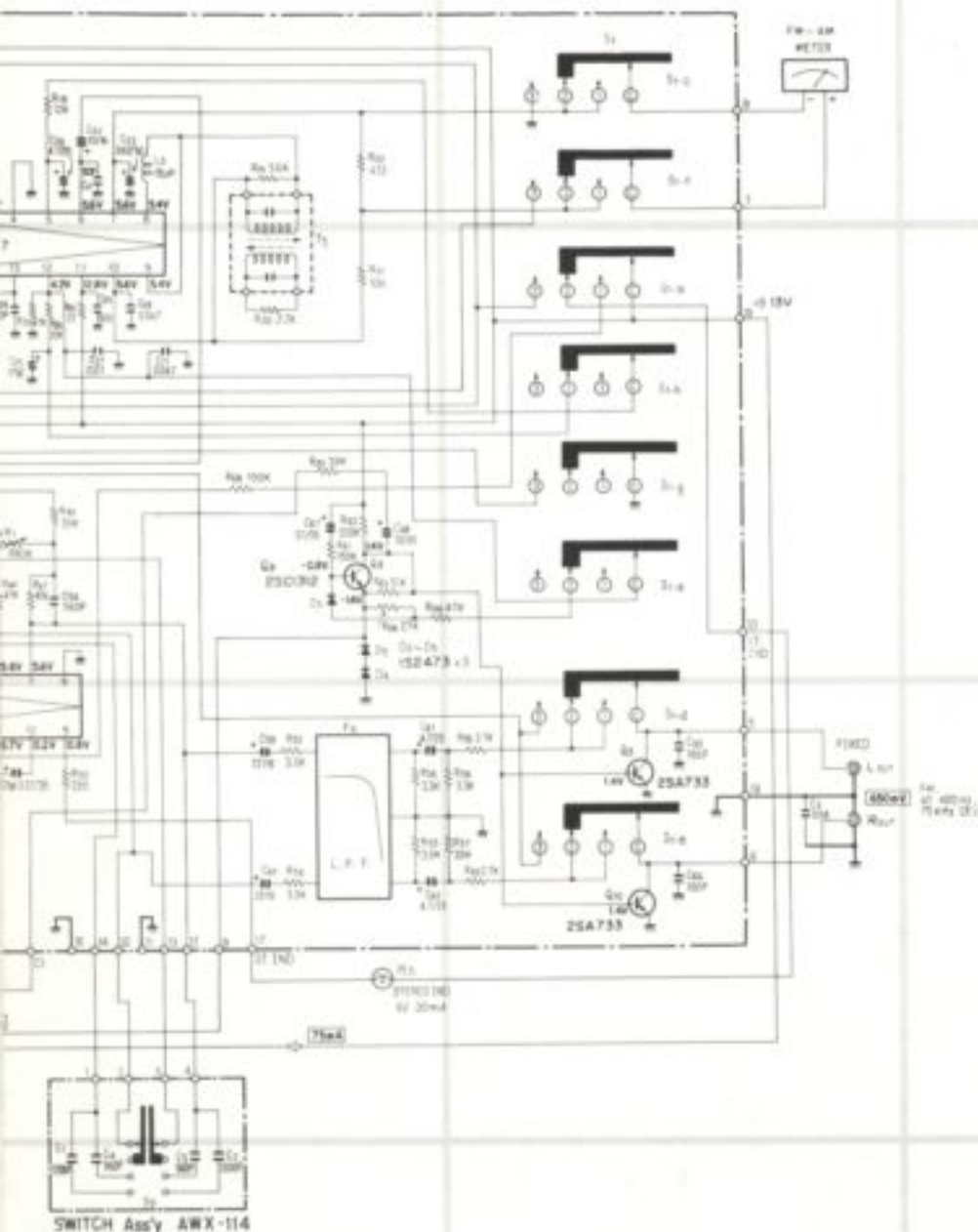

SWITCHES:

- 3 FUNCTION
- 1 FM MODE
- 2 FM AUTO
- 3 AM
- 3 POWER
- 3a OFF - ON
- 3b 250K - 50K
- 3c LINE VOLTAGE SELECTOR
- 10V - 120V - 220V - 240V
- 3d 30 CURRENT AT NO INPUT SIGNAL

RESISTORS:

IN OHM, Ω , K, M, TO BE ADDED UNLESS NOTED X, K, M, MG

CAPACITORS:

IN μ UNLESS OTHERWISE NOTED P, pF

4

5

6

1

2

3

FM-AM
METER



Foil side

AWR-134, No.12

AWR-134, No.6

PL₂
STEREO
IND
6V30mA

AWX-114, No.3

AWX-114, No.1

AWX-114, No.2

AWX-114, No.4

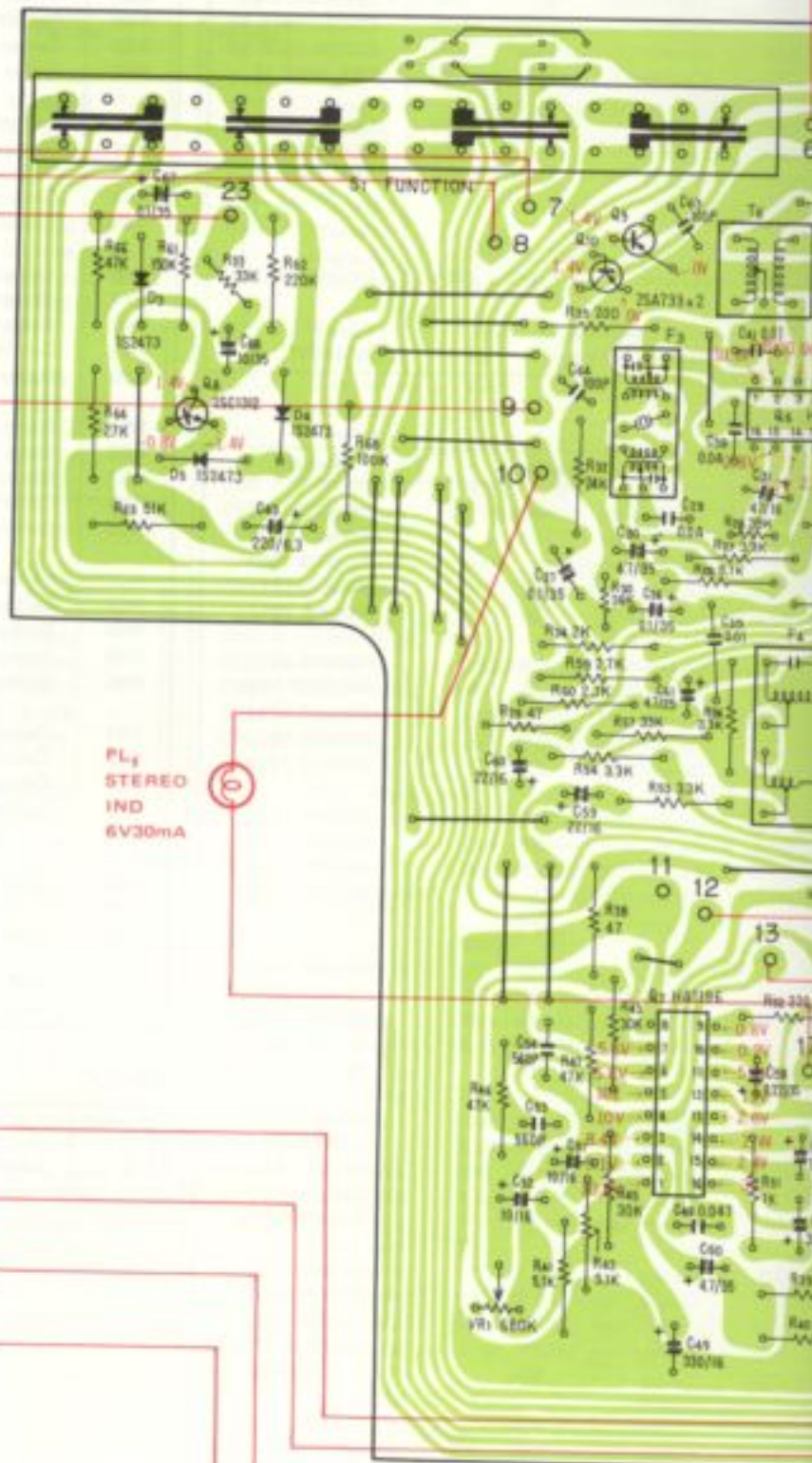

A

B

C

D

1

2

3

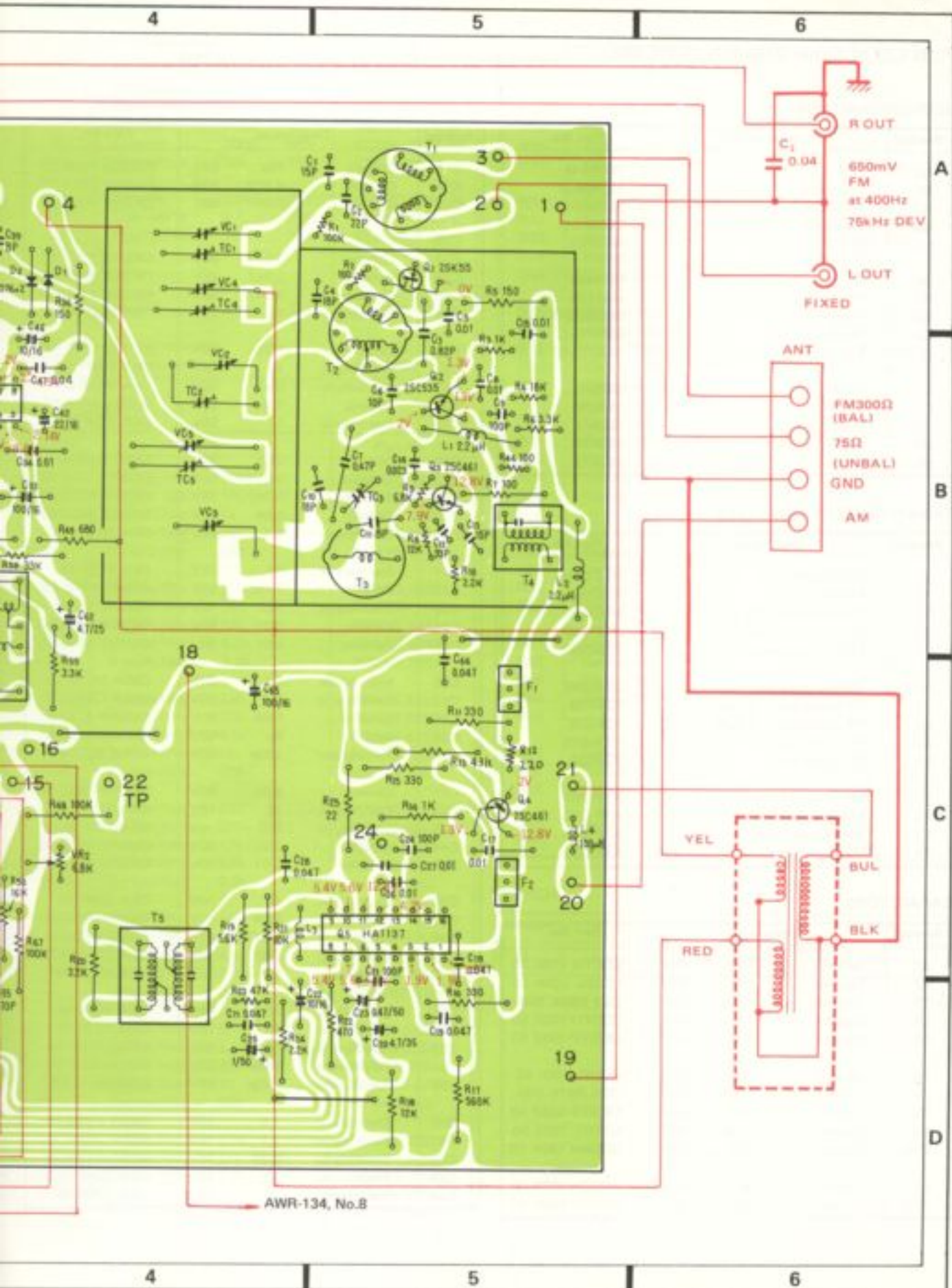

Parts List of Tuner Assembly (AWE-088)

SEMICONDUCTORS

Symbol	Description	Part No.
Q1	FET	2SK55-D
Q2	Transistor	2SC535-A
Q3	Transistor	2SC461-B
Q4	Transistor	2SC461-B
Q5	IC	HA1137
Q6	IC	HA1138
Q7	IC	HA1196
Q8	Transistor	2SC1312-G or F
Q9	Transistor	2SA733-Q or R
Q10	Transistor	2SA733-Q or R
D1	Diode	1S2076
D2	Diode	1S2076
D3	Diode	1S2473
D4	Diode	1S2473
D5	Diode	1S2473

TRANSFORMERS AND COILS

Symbol	Description	Part No.
T1	FM antenna coil	ATC-030
T2	FM RF coil	ATC-024
T3	FM oscillator coil	ATC-031
T4	FM IF transformer	ATE-008
T5	FM IF transformer	T73-035
T6	AM oscillator coil	ATB-039
L1	RF choke coil 2.2 μ H	T24-028
L2	RF choke coil 2.2 μ H	T24-028
L3	RF choke coil	ATH-015
L4	RF choke coil	T24-030
F1	FM ceramic filter	ATF-013
F2	FM ceramic filter	ATF-013
F3	AM ceramic filter	ATF-027
F4	MPX L.P. filter	ATF-033

CAPACITORS

Symbol	Description	Part No.
C1	Ceramic 15p 50V	CCDTH 150K 50
C2	Ceramic 22p 50V	CCDSL 220K 50
C3	Ceramic 0.82p 500V	CGB R82K 500
C4	Ceramic 18p 50V	CCDTH 180K 50
C5	Ceramic 0.01 50V	CKDYF 103Z 50
C6	Ceramic 10p 50V	CCDSL 100F 50
C7	Ceramic 0.47p 500V	CGB R47K 500
C8	Ceramic 0.01 50V	CKDYF 103Z 50
C9	Ceramic 100p 50V	CCDSL 101K 50
C10	Ceramic 18p 50V	CCDRH 180K 50
C11	Ceramic 8p 50V	CCDSH 080F 50
C12	Ceramic 33p 50V	CCDCH 330K 50

Symbol	Description	Part No.
C13	Ceramic 15p 50V	CCDCH 150K 50
C14	Ceramic 0.022 50V	CKDYF 223K 50
C15	Ceramic 0.01 50V	CKDYF 103Z 50
C16
C17	Ceramic 0.01 50V	CKDYF 103Z 50
C18	Ceramic 0.047 25V	CKDBC 473Z 25
C19	Ceramic 0.047 25V	CKDBC 473Z 25
C20	Electrolytic 4.7 35V	CEA 4R7P 35
C21	Ceramic 100p 50V	CCDSL 101K 50
C22	Electrolytic 10 16V	CEA 100P 16
C23	Electrolytic 0.47 50V	CEA R47P 50
C24	Ceramic 100p 50V	CCDSL 101K 50
C25	Electrolytic 1 50V	CEA 010P 50
C26	Ceramic 0.01 50V	CKDYF 103Z 50
C27	Ceramic 0.01 50V	CKDYF 103Z 50
C28	Ceramic 0.047 25V	CKDBC 473Z 25
C29	Ceramic 0.04 50V	CKDYF 403Z 50
C30	Electrolytic 4.7 35V	CEA 4R7P 35
C31	Electrolytic 47 16V	CEA 470P 16
C32	Ceramic 220p 50V	CCDSL 221K 50
C33	Electrolytic 100 16V	CEA 101P 16
C34	Ceramic 0.01 50V	CKDYB 103K 50
C35	Ceramic 0.01 50V	CKDYF 103Z 50
C36	Electrolytic 0.1 35V	CSZA 0R1M 35
C37	Electrolytic 0.1 35V	CSZA 0R1M 35
C38	Ceramic 0.04 50V	CKDYF 403Z 50
C39	Ceramic 8p 50V	CCDXL 080F 50
C40	Polystyrene 330p 50V	CQSA 331J 50
C41	Ceramic 0.01 50V	CKDYF 103Z 50
C42	Electrolytic 22 16V	CEA 220P 16
C43	Electrolytic 220 6V	CEA 221P 6
C44	Ceramic 0.01 50V	CKDYF 103Z 50
C45	Ceramic 0.01 50V	CKDYF 103Z 50
C46	Electrolytic 10 16V	CEA 100P 16
C47	Ceramic 0.04 50V	CKDYF 403Z 50
C48	Mylar 0.047 50V	CQMA 473K 50
C49	Electrolytic 330 16V	CEA 331P 16
C50	Electrolytic 4.7 35V	CEA 4R7P 35
C51	Electrolytic 10 16V	CEA 100P 16
C52	Electrolytic 10 16V	CEA 100P 16
C53	Polystyrene 560p 50V	CQSA 561G 50
C54	Polystyrene 560p 50V	CQSA 561G 50
C55	Polystyrene 510p 50V	CQSH 511J 50
C56	Electrolytic 1.5 25V	CSZA 1R5M 25
C57	Electrolytic 3.3 16V	CSZA 3R3M 16
C58	Electrolytic 0.22 35V	CSZA R22M 35
C59	Electrolytic 22 16V	CEA 220P 16
C60	Electrolytic 22 16V	CEA 220P 16

Symbol	Description	Part No.
C61	Electrolytic 4.7 25V	CSZA 4R7M 25
C62	Electrolytic 4.7 25V	CSZA 4R7M 25
C63	Ceramic 100p 50V	CCDSL 101K 50
C64	Ceramic 100p 50V	CCDSL 101K 50
C65	Electrolytic 100 16V	CEA 101P 16
C66	Ceramic 0.047 25V	CKDBC 473Z 25
C67	Electrolytic 0.1 35V	CSZA 0R1M 35
C68	Electrolytic 10 35V	CEA 100P 35
C69
C70
C71	Ceramic 0.047 25V	CKDBC 473Z 25
VC	Tuning capacitor	ACK-017
TC3	Ceramic trimmer	ACM-006

RESISTORS

Symbol	Description	Part No.
R1	Carbon film 100k	RD%VS 104J
R2	Carbon film 100	RD%VS 101J
R3	Carbon film 1k	RD%VS 102J
R4	Carbon film 18k	RD%VS 183J
R5	Carbon film 150	RD%PS 151J
R6	Carbon film 3.3k	RD%VS 332J
R7	Carbon film 100	RD%PSF 101J
R8	Carbon film 12k	RD%VS 123J
R9	Carbon film 6.8k	RD%VS 682J
R10	Carbon film 2.2k	RD%VS 222J
R11	Carbon film 330	RD%PS 331J
R12	Carbon film 220	RD%PS 221J
R13	Carbon film 4.3k	RD%PS 432J
R14	Carbon film 1k	RD%PS 102J
R15	Carbon film 330	RD%PS 331J
R16	Carbon film 330	RD%PS 331J
R17	Carbon film 560k	RD%PS 564J
R18	Carbon film 12k	RD%PS 123J
R19	Carbon film 5.6k	RD%PS 562J
R20	Carbon film 2.2k	RD%PS 222J
R21	Carbon film 10k	RD%PS 103J
R22	Carbon film 470	RD%PS 471J
R23	Carbon film 47k	RD%VS 473J
R24	Carbon film 2.2k	RD%PS 222J
R25	Carbon film 22	RD%PSF 220J
R26	Carbon film 5.1k	RD%PS 512J
R27	Carbon film 3.3k	RD%PS 332J
R28	Carbon film 39k	RD%VS 393J
R29	Carbon film 47	RD%PSF 470J
R30	Carbon film 24k	RD%VS 243J
R31	Carbon film 2.2k	RD%PS 222J
R32	Carbon film 24k	RD%PS 243J
R33	Carbon film 33k	RD%VS 333J
R34	Carbon film 2k	RD%PS 202J
R35	Carbon film 200	RD%PS 201J

Symbol	Description	Part No.
R36	Carbon film 150	RD%PS 151J
R37	Carbon film 3.3k	RD%PS 332J
R38	Carbon film 47	RD%PSF 470J
R39	Carbon film 100k	RD%PS 104J
R40	Carbon film 51k	RD%PS 513J
R41	Carbon film 5.1k	RD%PS 512J
R42	Carbon film 5.1k	RD%PS 512J
R43	Carbon film 30k	RD%PS 303J
R44	Carbon film 100	RD%PSF 101J
R45	Carbon film 30k	RD%PS 303J
R46	Carbon film 47k	RD%PS 473J
R47	Carbon film 47k	RD%PS 473J
R48	Carbon film 100k	RD%PS 104J
R49	Carbon film 680	RD%PS 681J
R50	Carbon film 16k	RD%PS 163J
R51	Carbon film 1k	RD%PS 102J
R52	Carbon film 220	RD%PS 221J
R53	Carbon film 3.3k	RD%PS 332J
R54	Carbon film 3.3k	RD%PS 332J
R55	Carbon film 3.3k	RD%PS 332J
R56	Carbon film 3.3k	RD%PS 332J
R57	Carbon film 33k	RD%PS 333J
R58	Carbon film 33k	RD%PS 333J
R59	Carbon film 2.7k	RD%PS 272J
R60	Carbon film 2.7k	RD%PS 272J
R61	Carbon film 150k	RD%PS 154J
R62	Carbon film 220k	RD%PS 224J
R63	Carbon film 51k	RD%PS 513J
R64	Carbon film 27k	RD%PS 273J
R65
R66	Carbon film 47k	RD%PS 473J
R67	Carbon film 100k	RD%PS 104J
R68	Carbon film 100k	RD%PS 104J
VR1	Semi-fixed 680k-B	C92-064
VR2	Semi-fixed 6.8k-B	ACP-055

SWITCH

Symbol	Description	Part No.
S1	Lever switch (FUNCTION)	ASK-104

1.3 SWITCH ASSEMBLY (AWX-114)

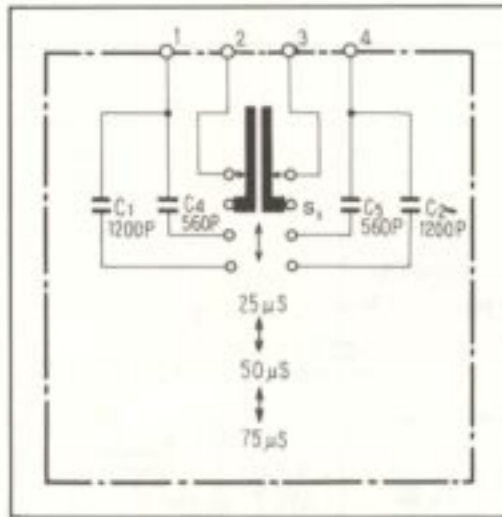

AWE-088, No. 14

AWE-088, No. 15

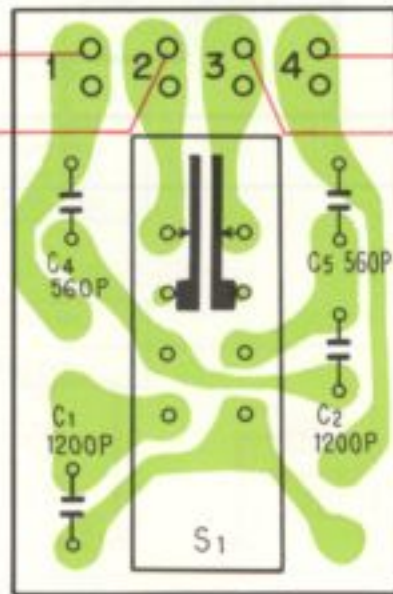

AWE-088, No. 12

AWE-088, No. 13

Parts List of Switch Assembly (AWX-114)

SWITCH

Symbol	Description	Part No.
S1	Slide switch (DE-EMPHASIS)	ASH-017

CAPACITORS

Symbol	Description	Part No.
C1	Ceramic 1200p 50V	CKDYA 122J 50
C2	Ceramic 1200p 50V	CKDYA 122J 50
C3	Polystyrene 560p 50V	CQSA 561J 50
C4	Polystyrene 560p 50V	CQSA 561J 50

1.4 POWER SUPPLY ASSEMBLY (AWR-134)

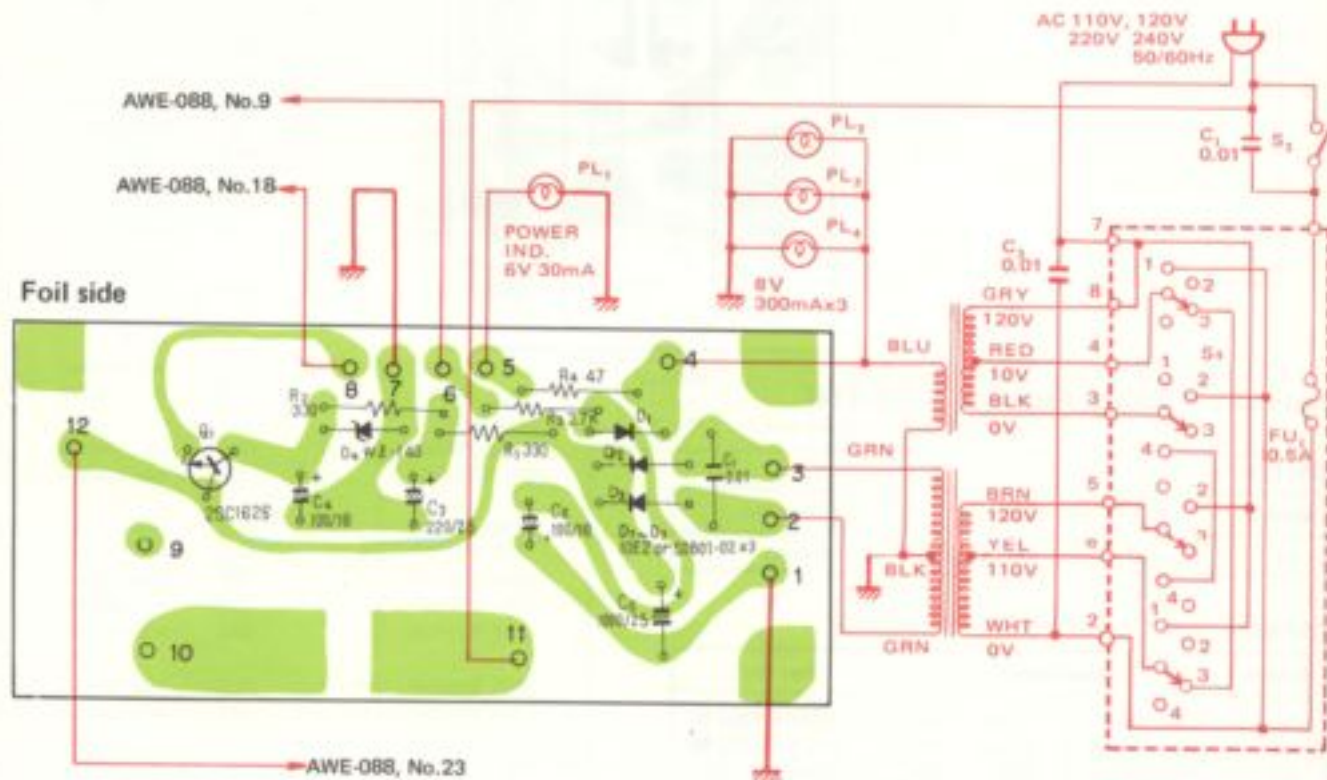
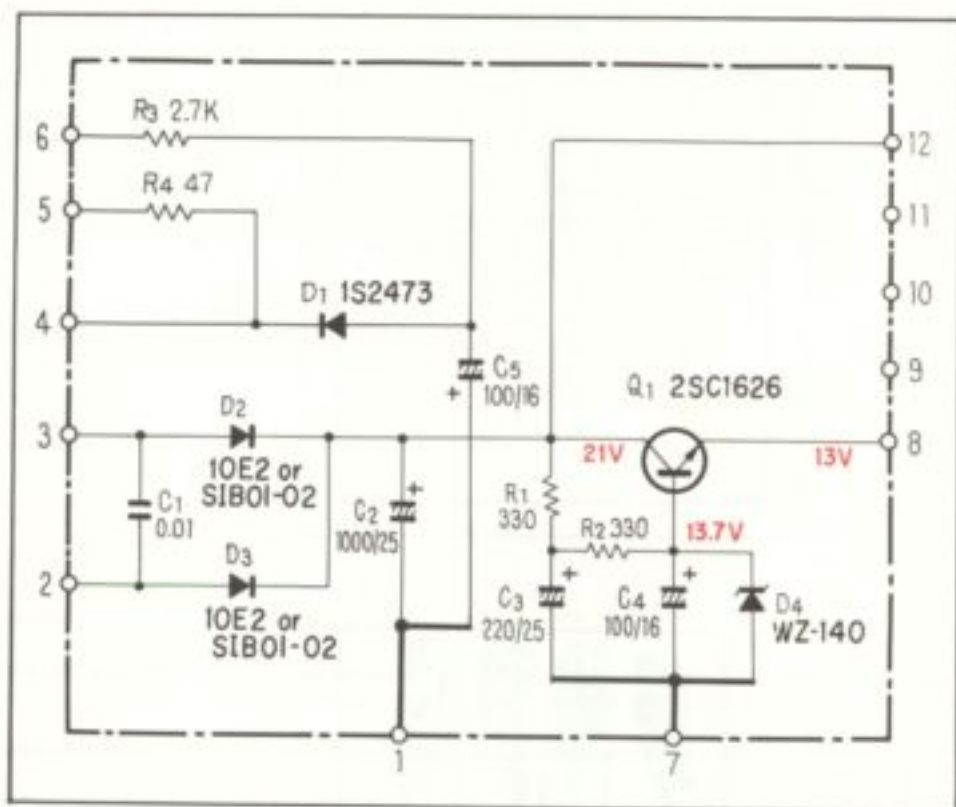

Parts List of Power Supply Assembly (AWR-134)

SEMICONDUCTORS

Symbol	Description	Part No.
Q1	Transistor	2SC1626-O or Y
D1	Diode	1S2473
D2	Diode	S1B01-02 (10E2)
D3	Diode	S1B01-02 (10E2)
D4	Zener diode	WZ-140

CAPACITORS

Symbol	Description	Part No.
C1	Ceramic 0.01 150V	ACG-004
C2	Electrolytic 100 25V	CEA 101P 25
C3	Electrolytic 220 25V	CEA 221P 25
C4	Electrolytic 100 16V	CEA 101P 16
C5	Electrolytic 100 16V	CEA 101P 16

RESISTORS

Symbol	Description	Part No.
R1	Carbon film 330	RD%PS 331J
R2	Carbon film 330	RD%PS 331J
R3	Carbon film 2.7k	RD%PS 272J
R4	Carbon film 47	RD%PS 470J

OTHERS

Symbol	Description	Part No.
	Heat sink	ANH-117

2. HG TYPE

2.1 SCHEMATIC DIAGRAM AND MISCELLANEOUS PARTS

Miscellaneous Parts List

NOTES:

- Capacitors: in μF unless otherwise noted p : pF
- Resistors: in Ω , $\frac{1}{2}W$ unless otherwise noted k : $k\Omega$, M : $M\Omega$

SWITCHES

Symbol	Description	Part No.
S2	Lever switch (POWER)	ASK-096
S4	Plug in selector (Line voltage selector)	AKX-037

TRANSFORMER AND COIL

Symbol	Description	Part No.
T1	Power transformer	ATT-353
T2	Bar antenna	ATB-505

CAPACITOR

Symbol	Description	Part No.
C2	Ceramic 0.04 50V	CKDYF 403Z 50

LAMPS AND FUSES

Symbol	Description	Part No.
PL1	Lamp with wire 6V, 30mA	AEL-059
PL2	Lamp assembly 8V, 300mA	AEL-085
PL3	Lamp assembly 8V, 300mA	AEL-085
PL4	Lamp assembly 8V, 300mA	AEL-085
PL5	Lamp with wire 6V, 30mA	AEL-059
FU1	Fuse 500mA (Primary)	AEK-401
FU2	Fuse 1.5A (Secondary)	AEK-405
FU3	Fuse 500mA (Secondary)	AEK-401
FU4	Fuse 500mA (Secondary)	AEK-401

Schematic Diagram

TUNER Ass'y AWE-087

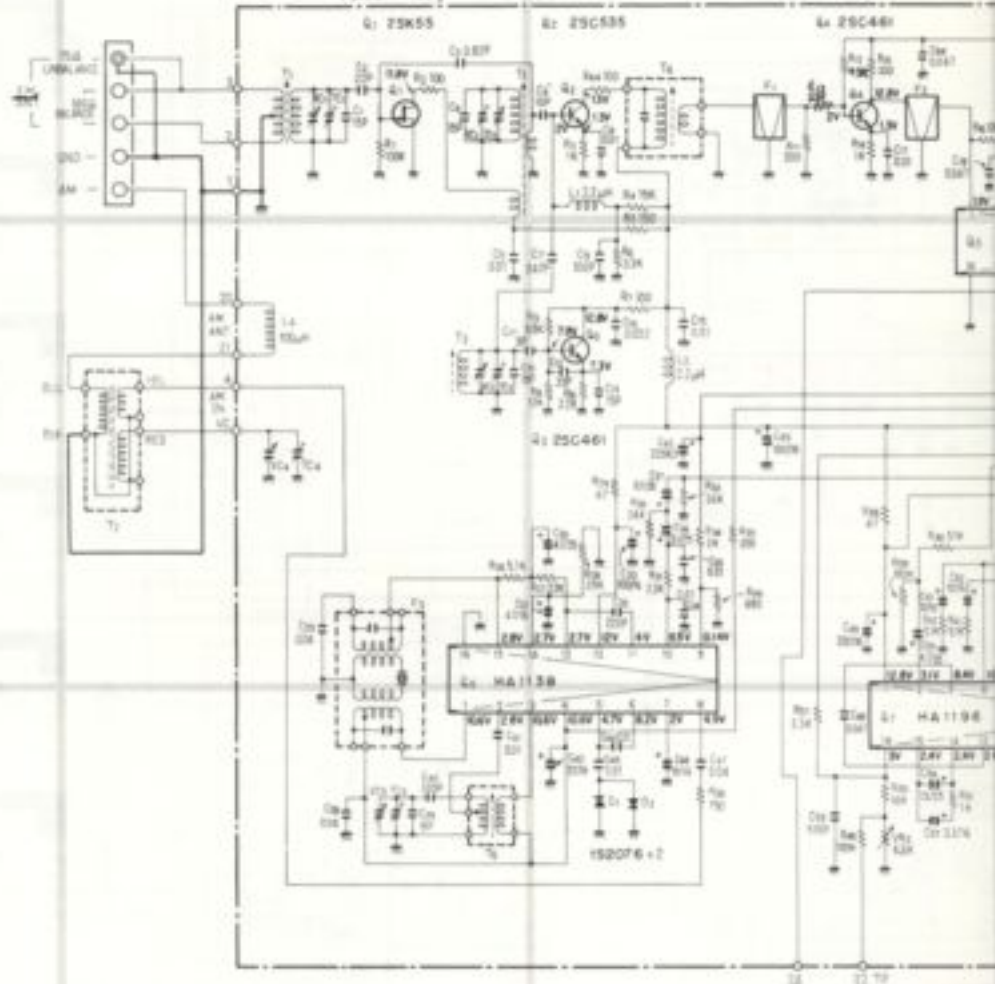

POWER SUPPLY Ass'y AWR-124

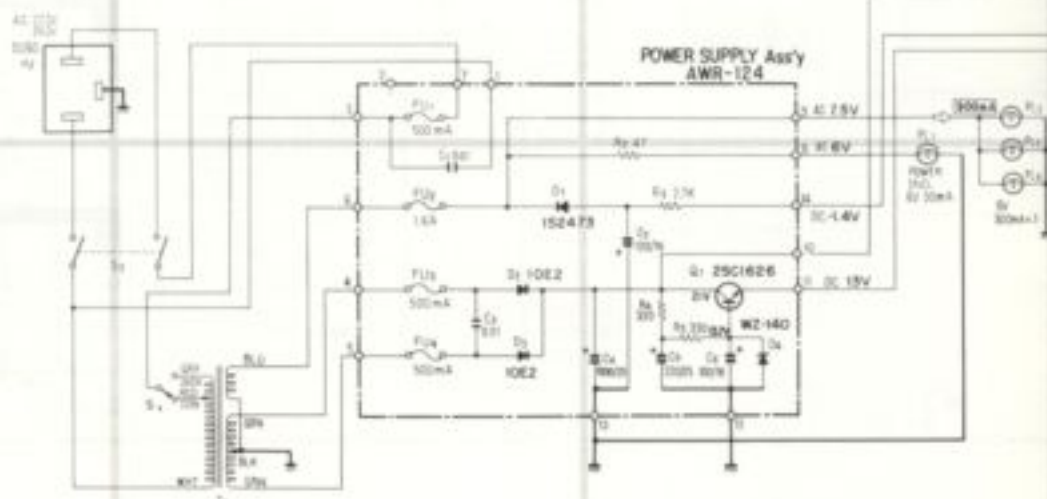

2.2 TUNER ASSEMBLY (AWE-087)

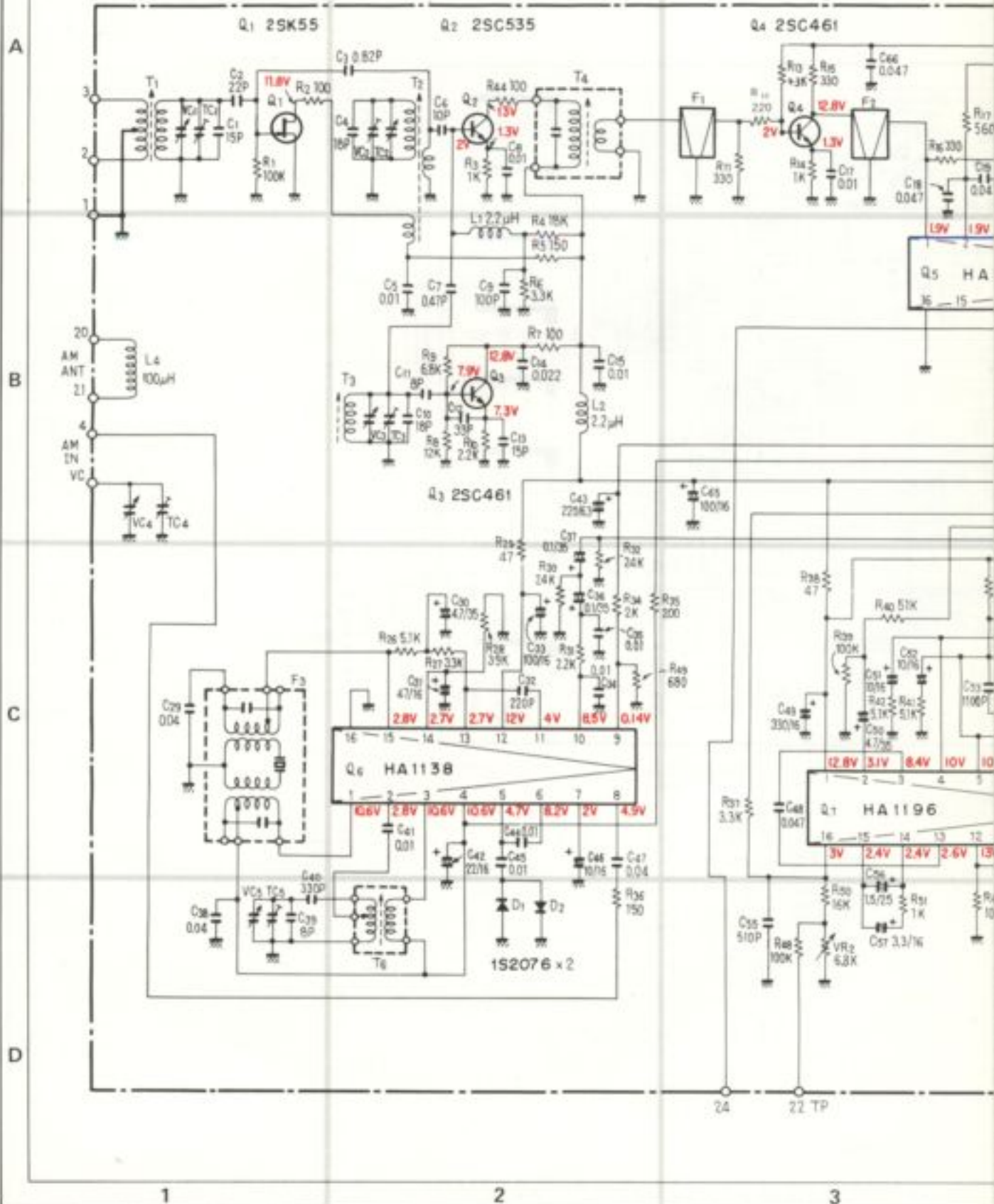

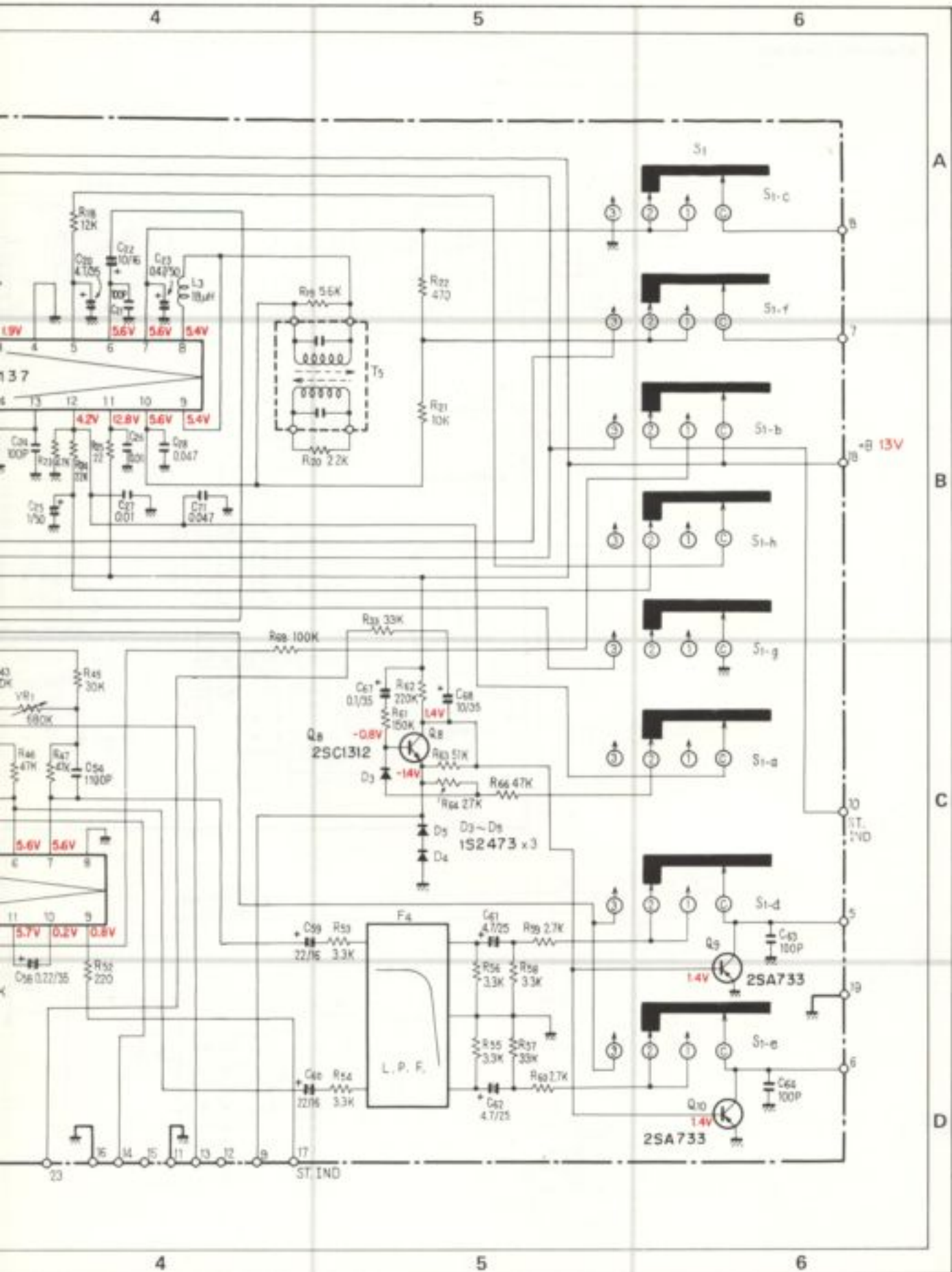

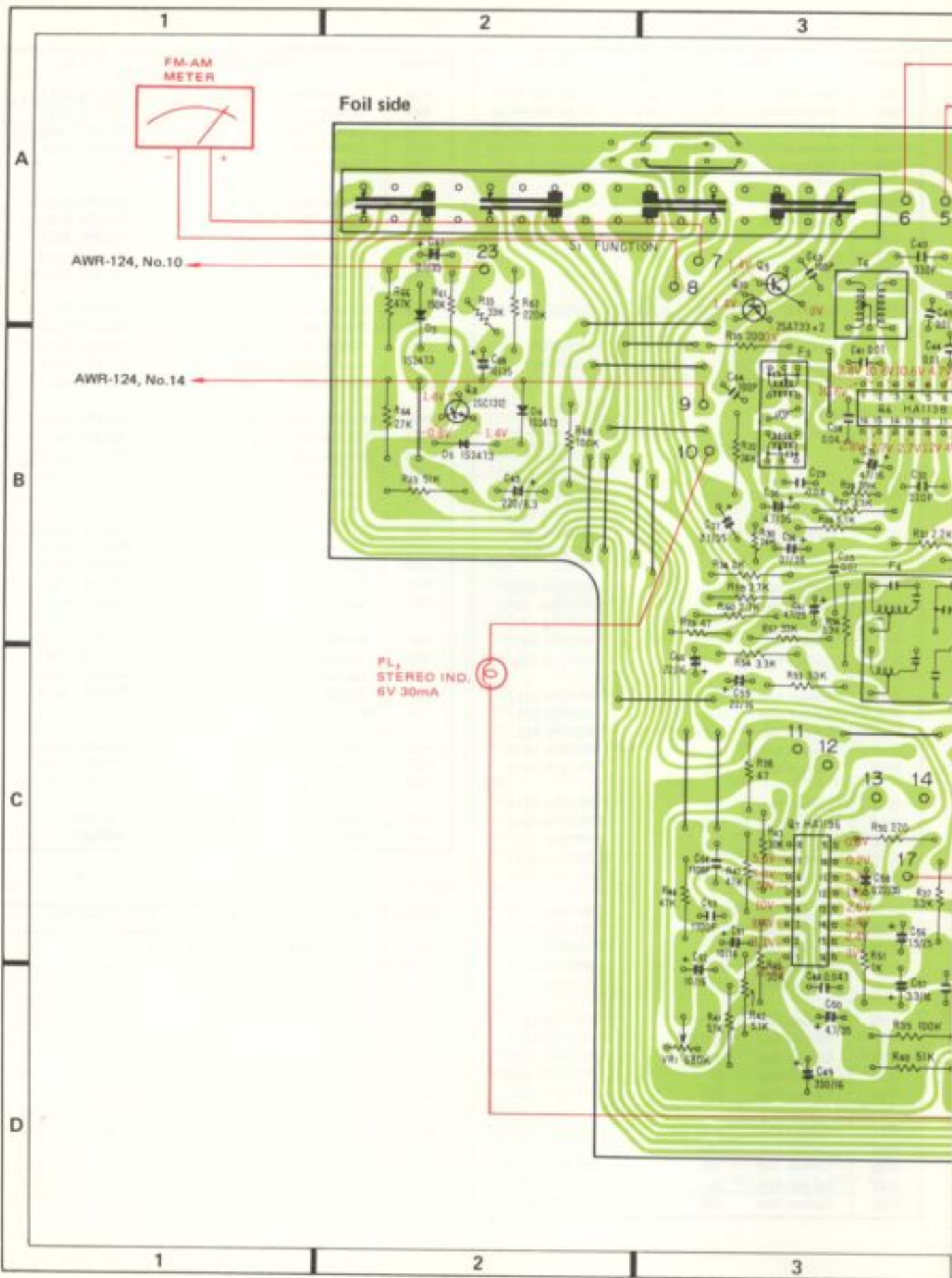

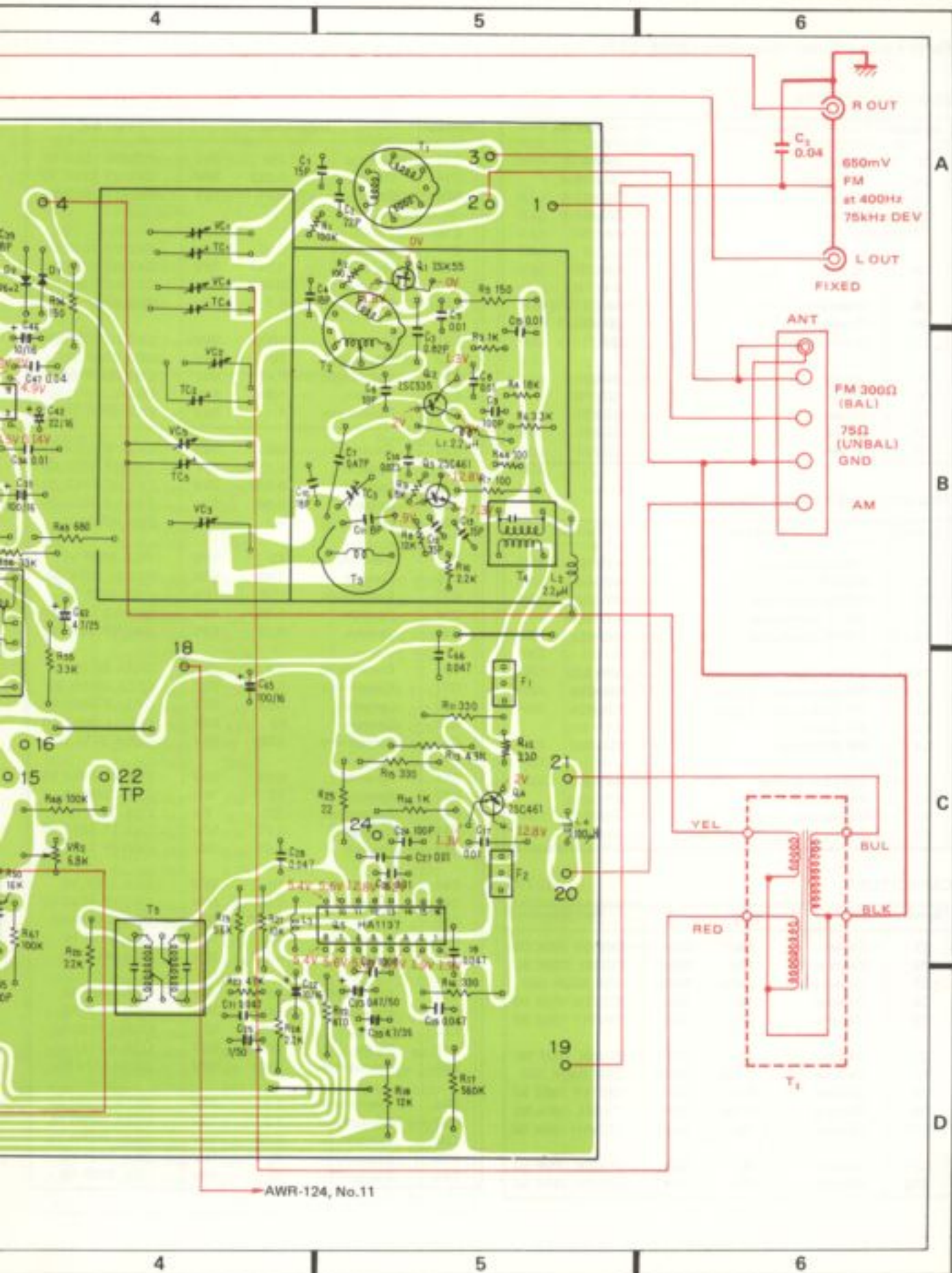

Parts List of Tuner Assembly (AWE-087)

SEMICONDUCTORS

Symbol	Description	Part No.
Q1	FET	2SK55-D
Q2	Transistor	2SC535-A
Q3	Transistor	2SC461-B
Q4	Transistor	2SC461-B
Q5	IC	HA1137
Q6	IC	HA1138
Q7	IC	HA1196
Q8	Transistor	2SC1312-G or F
Q9	Transistor	2SA733-Q or R
Q10	Transistor	2SA733-Q or R
D1	Diode	1S2076
D2	Diode	1S2076
D3	Diode	1S2473
D4	Diode	1S2473
D5	Diode	1S2473

TRANSFORMERS AND COILS

Symbol	Description	Part No.
T1	FM antenna coil	ATC-030
T2	FM RF coil	ATC-024
T3	FM oscillator coil	ATC-031
T4	FM IF transformer	ATE-008
T5	FM IF transformer	T73-035
T6	AM oscillator coil	AT8-039
L1	RF choke coil 2.2 μ H	T24-028
L2	RF choke coil 2.2 μ H	T24-028
L3	RF choke coil	ATH-015
L4	RF choke coil	T24-030
F1	FM ceramic filter	ATF-013
F2	FM ceramic filter	ATF-013
F3	AM ceramic filter	ATF-027
F4	MPX L.P. filter	ATF-033

CAPACITORS

Symbol	Description	Part No.
C1	Ceramic 15p 50V	CCDTH 150K 50
C2	Ceramic 22p 50V	CCDSL 220K 50
C3	Ceramic 0.82p 500V	CGB R82K 500
C4	Ceramic 18p 50V	CCDTH 180K 50
C5	Ceramic 0.01 50V	CKDYF 103Z 50
C6	Ceramic 10p 50V	CCDSL 100F 50
C7	Ceramic 0.47p 500V	CGB R47K 500
C8	Ceramic 0.01 50V	CKDYF 103Z 50
C9	Ceramic 100p 50V	CCDSL 101k 50
C10	Ceramic 18p 50V	CCDRH 180K 50
C11	Ceramic 8p 50V	CCDSH 080F 50
C12	Ceramic 33p 50V	CCDCH 330K 50

Symbol	Description	Part No.
C13	Ceramic 15p 50V	CCDCH 150K 50
C14	Ceramic 0.022 50V	CKDYF 223K 50
C15	Ceramic 0.01 50V	CKDYF 103Z 50
C16
C17	Ceramic 0.01 50V	CKDYF 103Z 50
C18	Ceramic 0.047 25V	CKDBC 473Z 25
C19	Ceramic 0.047 25V	CKDBC 473Z 25
C20	Electrolytic 4.7 35V	CEA 4R7P 35
C21	Ceramic 100p 50V	CCDSL 101K 50
C22	Electrolytic 10 16V	CEA 100P 16
C23	Electrolytic 0.47 50V	CEA R47P 50
C24	Ceramic 100p 50V	CCDSL 101K 50
C25	Electrolytic 1 50V	CEA 010P 50
C26	Ceramic 0.01 50V	CKDYF 103Z 50
C27	Ceramic 0.01 50V	CKDYF 103Z 50
C28	Ceramic 0.047 25V	CKDBC 473Z 25
C29	Ceramic 0.04 50V	CKDYF 403Z 50
C30	Electrolytic 4.7 35V	CEA 4R7P 35
C31	Electrolytic 47 16V	CEA 470P 16
C32	Ceramic 220p 50V	CCDSL 221K 50
C33	Electrolytic 100 16V	CEA 101P 16
C34	Ceramic 0.01 50V	CKDYB 103K 50
C35	Ceramic 0.01 50V	CKDYF 103Z 50
C36	Electrolytic 0.1 35V	CSZA 0R1M 35
C37	Electrolytic 0.1 35V	CSZA 0R1M 35
C38	Ceramic 0.04 50V	CKDYF 403Z 50
C39	Ceramic 8p 50V	CCDXL 080F 50
C40	Polystyrene 330p 50V	CQSA 331J 50
C41	Ceramic 0.01 50V	CKDYF 103Z 50
C42	Electrolytic 22 16V	CEA 220P 16
C43	Electrolytic 220 6V	CEA 221P 6
C44	Ceramic 0.01 50V	CKDYF 103Z 50
C45	Ceramic 0.01 50V	CKDYF 103Z 50
C46	Electrolytic 10 16V	CEA 100P 16
C47	Ceramic 0.04 50V	CKDYF 403Z 50
C48	Mylar 0.047 50V	COMA 473K 50
C49	Electrolytic 330 16V	CEA 331P 16
C50	Electrolytic 4.7 35V	CEA 4R7P 35
C51	Electrolytic 10 16V	CEA 100P 16
C52	Electrolytic 10 16V	CEA 100P 16
C53	Mylar 1100p 50V	COMA 112J 50
C54	Mylar 1100p 50V	COMA 112J 50
C55	Polystyrene 510p 50V	CQSH 511J 50
C56	Electrolytic 1.5 25V	CSZA 1R5M 25
C57	Electrolytic 3.3 16V	CSZA 3R3M 16
C58	Electrolytic 0.22 35V	CSZA R22M 35
C59	Electrolytic 22 16V	CEA 220P 16
C60	Electrolytic 22 16V	CEA 220P 16

Symbol	Description	Part No.
C61	Electrolytic 4.7 25V	CSZA 4R7M 25
C62	Electrolytic 4.7 25V	CSZA 4R7M 25
C63	Ceramic 100p 50V	CCDSL 101K 50
C64	Ceramic 100p 50V	CCDSL 101K 50
C65	Electrolytic 100 16V	CEA 101P 16
C66	Ceramic 0.047 25V	CKDBC 473Z 25
C67	Electrolytic 0.1 35V	CSZA 0R1M 35
C68	Electrolytic 10 35V	CEA 100P 35
C69
C70
C71	Ceramic 0.047 25V	CKDBC 473Z 25
VC	Tuning capacitor	ACK-017
TC3	Ceramic trimmer	ACM-006

RESISTORS

Symbol	Description	Part No.
R1	Carbon film 100k	RD%VS 104J
R2	Carbon film 100	RD%VS 101J
R3	Carbon film 1k	RD%VS 102J
R4	Carbon film 18k	RD%VS 183J
R5	Carbon film 150	RD%PS 151J
R6	Carbon film 3.3k	RD%VS 332J
R7	Carbon film 100	RD%PSF 101J
R8	Carbon film 12k	RD%VS 123J
R9	Carbon film 6.8k	RD%VS 682J
R10	Carbon film 2.2k	RD%VS 222J
R11	Carbon film 330	RD%PS 331J
R12	Carbon film 220	RD%PS 221J
R13	Carbon film 4.3k	RD%PS 432J
R14	Carbon film 1k	RD%PS 102J
R15	Carbon film 330	RD%PS 331J
R16	Carbon film 330	RD%PS 331J
R17	Carbon film 560k	RD%PS 564J
R18	Carbon film 12k	RD%PS 123J
R19	Carbon film 6.8k	RD%PS 562J
R20	Carbon film 2.2k	RD%PS 222J
R21	Carbon film 10k	RD%PS 103J
R22	Carbon film 470	RD%PS 471J
R23	Carbon film 47k	RD%VS 473J
R24	Carbon film 2.2k	RD%PS 222J
R25	Carbon film 22	RD%PSF 220J
R26	Carbon film 5.1k	RD%PS 512J
R27	Carbon film 3.3k	RD%PS 332J
R28	Carbon film 39k	RD%VS 393J
R29	Carbon film 47	RD%PSF 470J
R30	Carbon film 24k	RD%VS 243J
R31	Carbon film 2.2k	RD%PS 222J
R32	Carbon film 24k	RD%PS 243J
R33	Carbon film 33k	RD%VS 333J
R34	Carbon film 2k	RD%PS 202J
R35	Carbon film 200	RD%PS 201J

Symbol	Description	Part No.
R36	Carbon film 150	RD%PS 151J
R37	Carbon film 3.3k	RD%PS 332J
R38	Carbon film 47	RD%PSF 470J
R39	Carbon film 100k	RD%PS 104J
R40	Carbon film 51k	RD%PS 513J
R41	Carbon film 5.1k	RD%PS 512J
R42	Carbon film 5.1k	RD%PS 512J
R43	Carbon film 30k	RD%PS 303J
R44	Carbon film 100	RD%PSF 101J
R45	Carbon film 30k	RD%PS 303J
R46	Carbon film 47k	RD%PS 473J
R47	Carbon film 47k	RD%PS 473J
R48	Carbon film 100k	RD%PS 104J
R49	Carbon film 680	RD%PS 681J
R50	Carbon film 16k	RD%PS 163J
R51	Carbon film 1k	RD%PS 102J
R52	Carbon film 220	RD%PS 221J
R53	Carbon film 3.3k	RD%PS 332J
R54	Carbon film 3.3k	RD%PS 332J
R55	Carbon film 3.3k	RD%PS 332J
R56	Carbon film 3.3k	RD%PS 332J
R57	Carbon film 33k	RD%PS 333J
R58	Carbon film 33k	RD%PS 333J
R59	Carbon film 2.7k	RD%PS 272J
R60	Carbon film 2.7k	RD%PS 272J
R61	Carbon film 150k	RD%PS 154J
R62	Carbon film 220k	RD%PS 224J
R63	Carbon film 51k	RD%PS 513J
R64	Carbon film 27k	RD%PS 273J
R65
R66	Carbon film 47k	RD%PS 473J
R67	Carbon film 100k	RD%PS 104J
R68	Carbon film 100k	RD%PS 104J
VR1	Semi-fixed 680k-B	C92-064
VR2	Semi-fixed 6.8k-B	ACP-065

SWITCH

Symbol	Description	Part No.
S1	Lever switch (FUNCTION)	ASK-104

2.3 POWER SUPPLY ASSEMBLY (AWR-124)

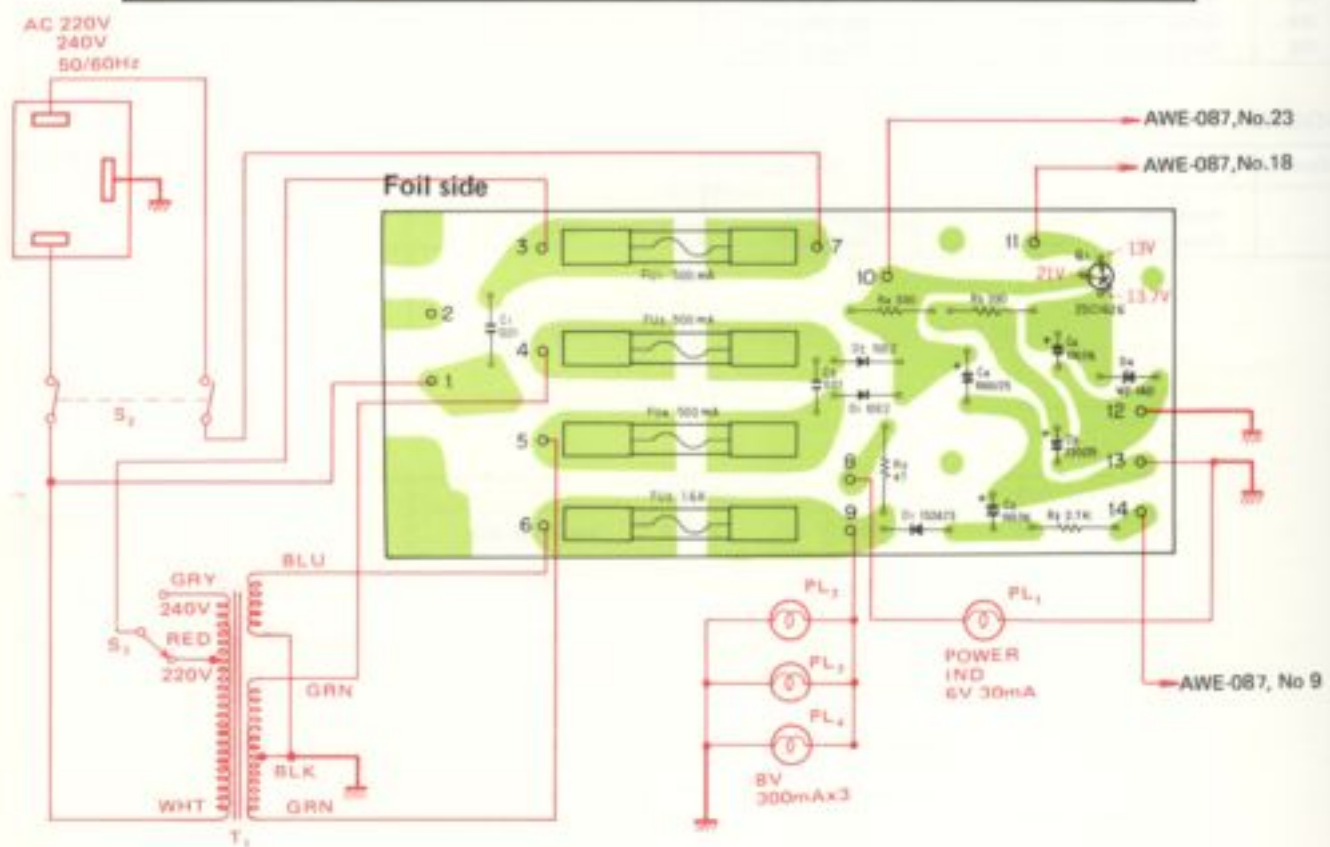
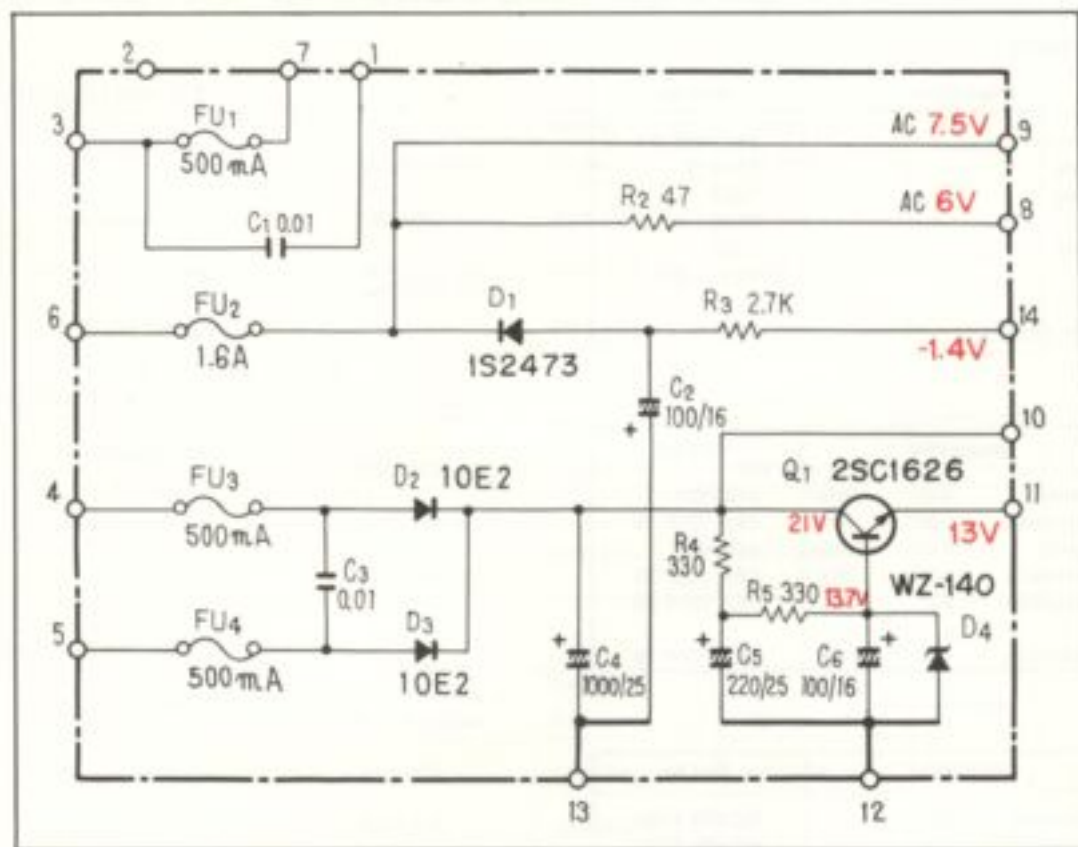

Parts List of Power Supply Assembly (AWR-124)

SEMICONDUCTORS

Symbol	Description	Part No.
Q1	Transistor	2SC1626-O or Y
D1	Diode	1S2473
D2	Diode	10E2 (S1B01-02)
D3	Diode	10E2 (S1B01-02)
D4	Zener diode	WZ-140

CAPACITORS

Symbol	Description	Part No.
C1	Ceramic 0.01 250V	ACG-001
C2	Electrolytic 100 16V	CEA 101P 16
C3	Ceramic 0.01 150V	ACG-004
C4	Electrolytic 1000 25V	CEA 102P 25
C5	Electrolytic 220 25V	CEA 221P 25
C6	Electrolytic 100 16V	CEA 101P 16

RESISTORS

Symbol	Description	Part No.
R2	Carbon film 47	RD%PS 470J
R3	Carbon film 2.7k	RD%PS 272J
R4	Carbon film 330	RD%PS 331J
R5	Carbon film 330	RD%PS 331J

OTHERS

Symbol	Description	Part No.
	Heat sink	ANH-117
	Fuse clip	AKR-010

3. CONTRAST OF MISCELLANEOUS PARTS

P.C. BOARD ASSEMBLIES

Symbol	Description	Part No.			Remarks
		KU, KC types	S type	HG type	
	Tuner assembly	AWE-062	AWE-088	AWE-087	
	Power supply assembly	AWR-097 (KU) AWR-137 (KC)	AWR-134	AWR-124	
	Switch assembly	AWX-114	

TRANSFORMERS

Symbol	Description	Part No.			Remarks
		KU, KC types	S type	HG type	
T1	Power transformer	ATT-298 (KU) ATT-286 (KC)	ATT-354	ATT-353	

SWITCHES

Symbol	Description	Part No.			Remarks
		KU, KC type	S type	HG type	
S2	Lever switch (POWER)	ASK-085	ASK-095	ASK-096	
S3	Slide switch (DE-EM.)	ASH-016	ASH-017	
S4	Plug in selector (Line voltage selector)	AKX-037	2 position
		AKR-031	4 position

CAPACITORS

Symbol	Description	Part No.			Remarks
		KU, KC type	S type	HG type	
C1	Ceramic 0.01 250V	ACG-001	
C2	Ceramic 0.04 50V	CKDYF 403Z 50	CKDYF 403Z 50	CKDYF 403Z 50	
C3	Ceramic 0.01 250V	ACG-001	

FUSES

Symbol	Description	Part No.			Remarks
		KU, KC types	S type	HG type	
FU1	Fuse 500mA (Primary)	AEK-107	AEK-107	AEK-401	
FU2	Fuse 1.5A (Secondary)	AEK-104	
	Fuse 1.6A (Secondary)	AEK-405	
FU3	Fuse 500mA (Secondary)	AEK-107	AEK-401	
FU4	Fuse 500mA (Secondary)	AEK-107	AEK-401	

OTHERS

Symbol	Description	Part No.			Remarks
		KU, KC type	S type	HG type	
	AC power cord	ADG-005	ADG-016	
	AC inlet	AKP-008	
	Antenna terminal	AKA-003	AKA-003	AKA-007	
	Packing case (English)	AHD-442 (KU)	AHD-442	
	Packing case (English/French)	AHD-443 (KC)	
	Packing case	AHD-444	
	Vinyl pouch	AHG-023	AHG-023	
	Operating instructions (English)	ARB-206	ARB-225	ARB-214	
	Operating instructions (Germany/French)	ARD-105	
	Accessory fuse 500mA	AEK-107	
	Vinyl pouch	E11-033	

AM/FM STEREO TUNER

TX-5500II

HG

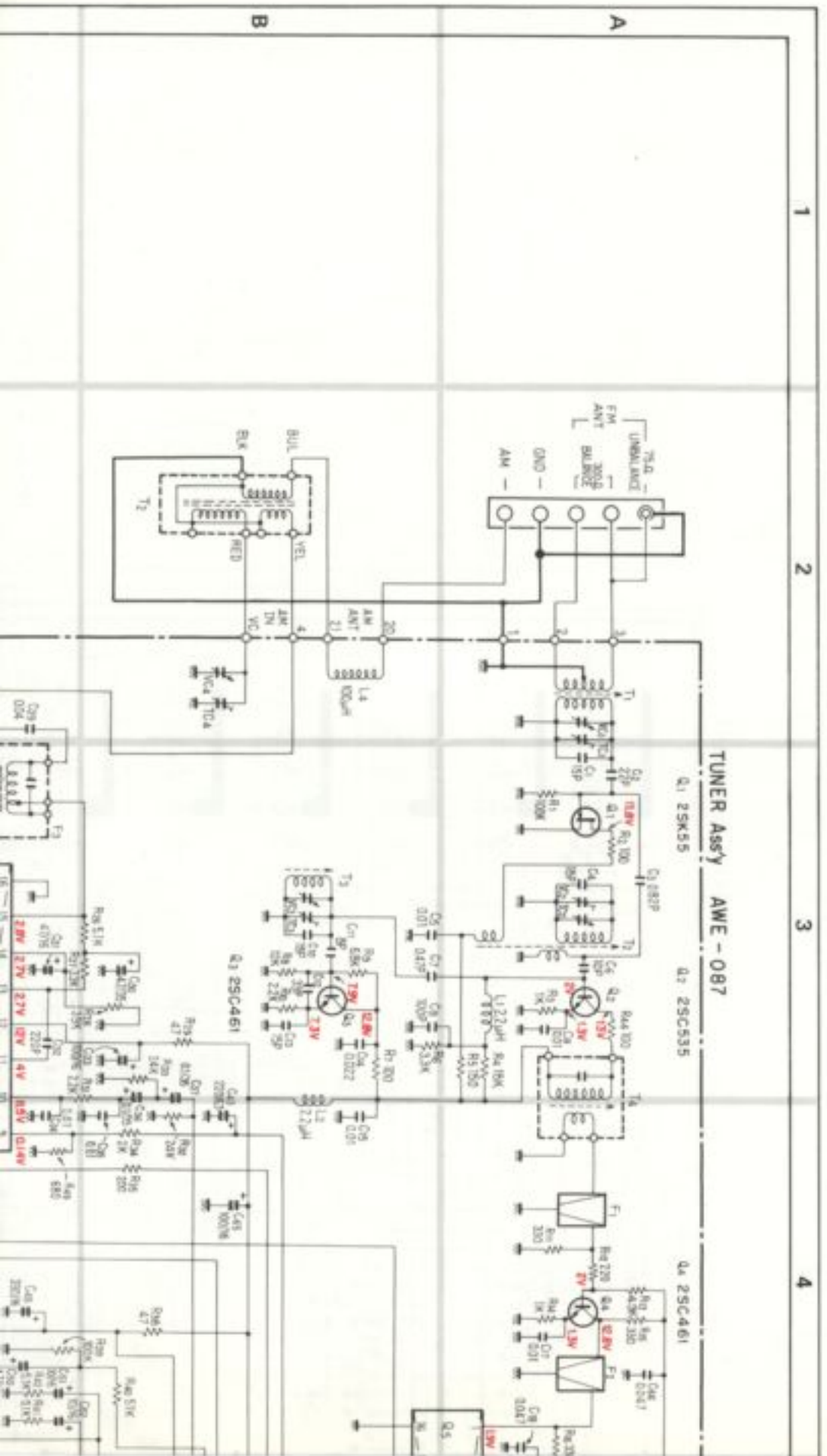

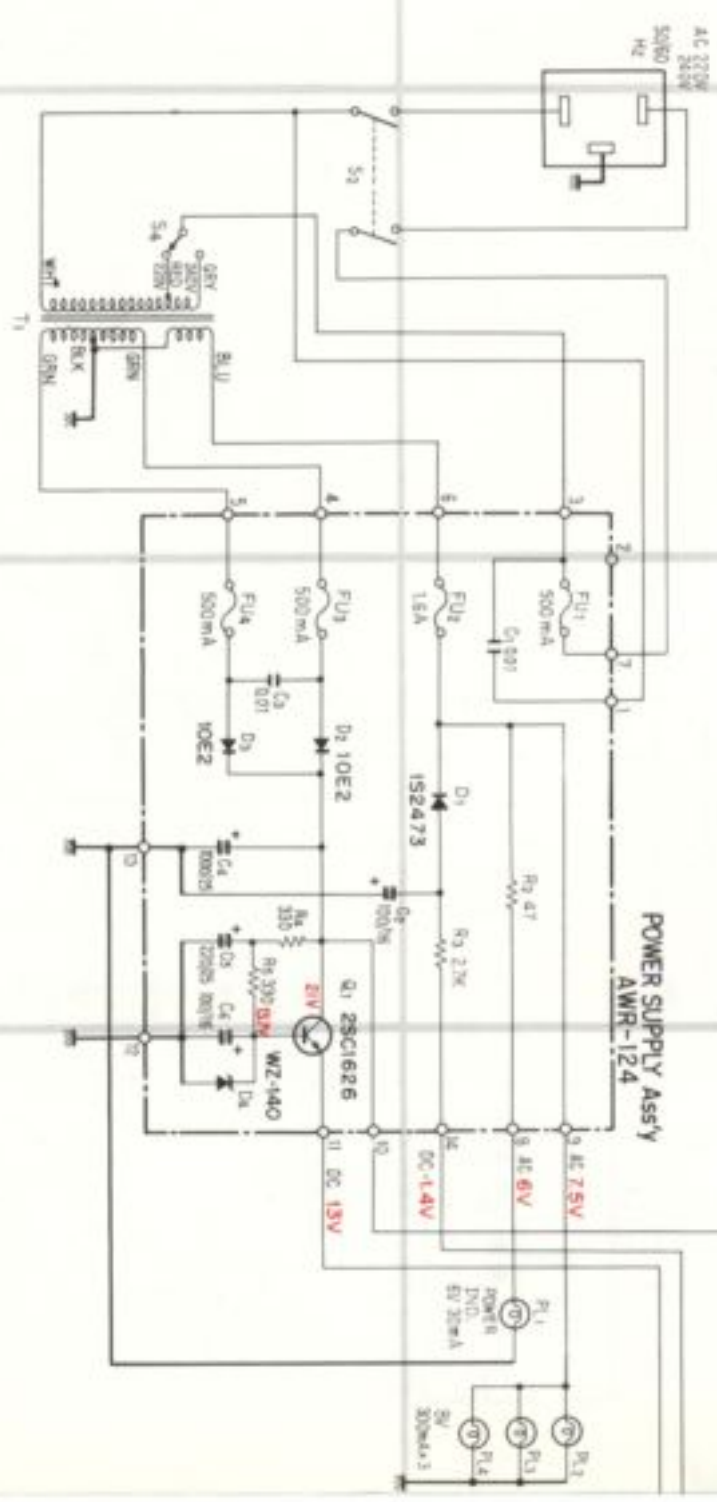
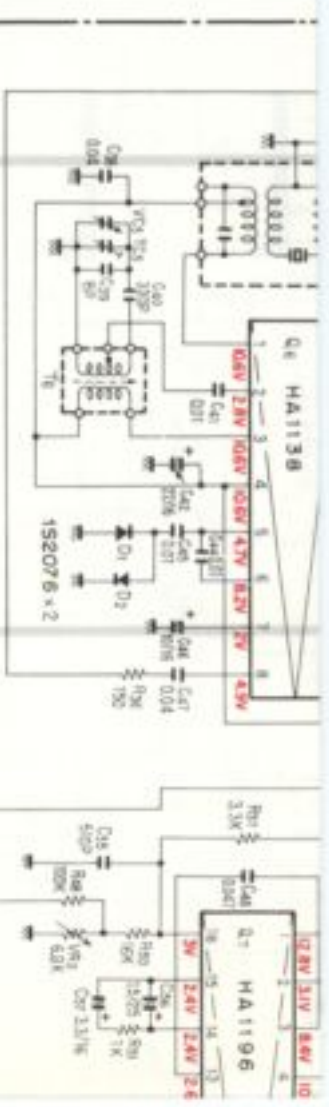

1
 2
 3
 4

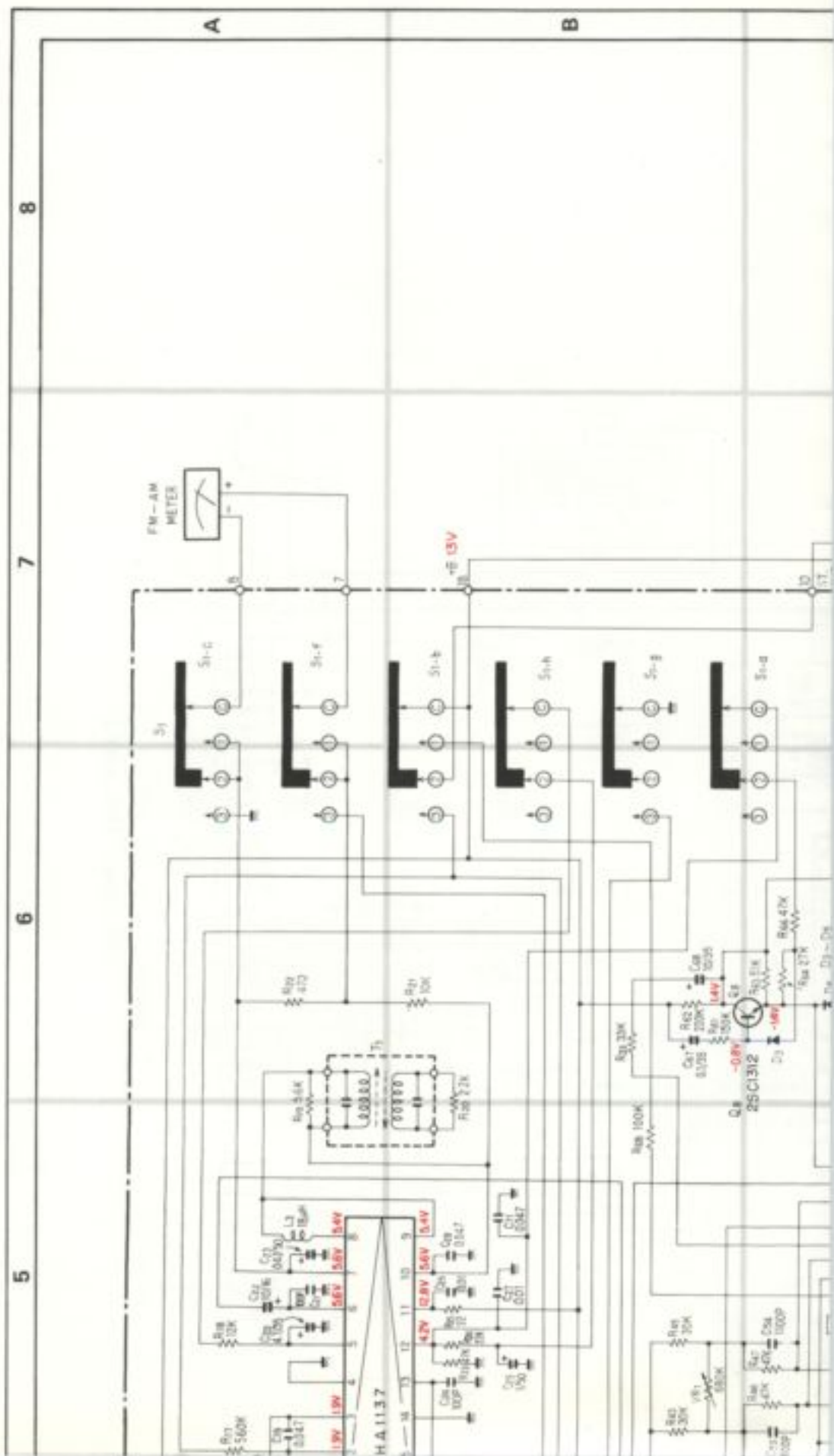

AM/FM STEREO TUNER

TX-6500II

S

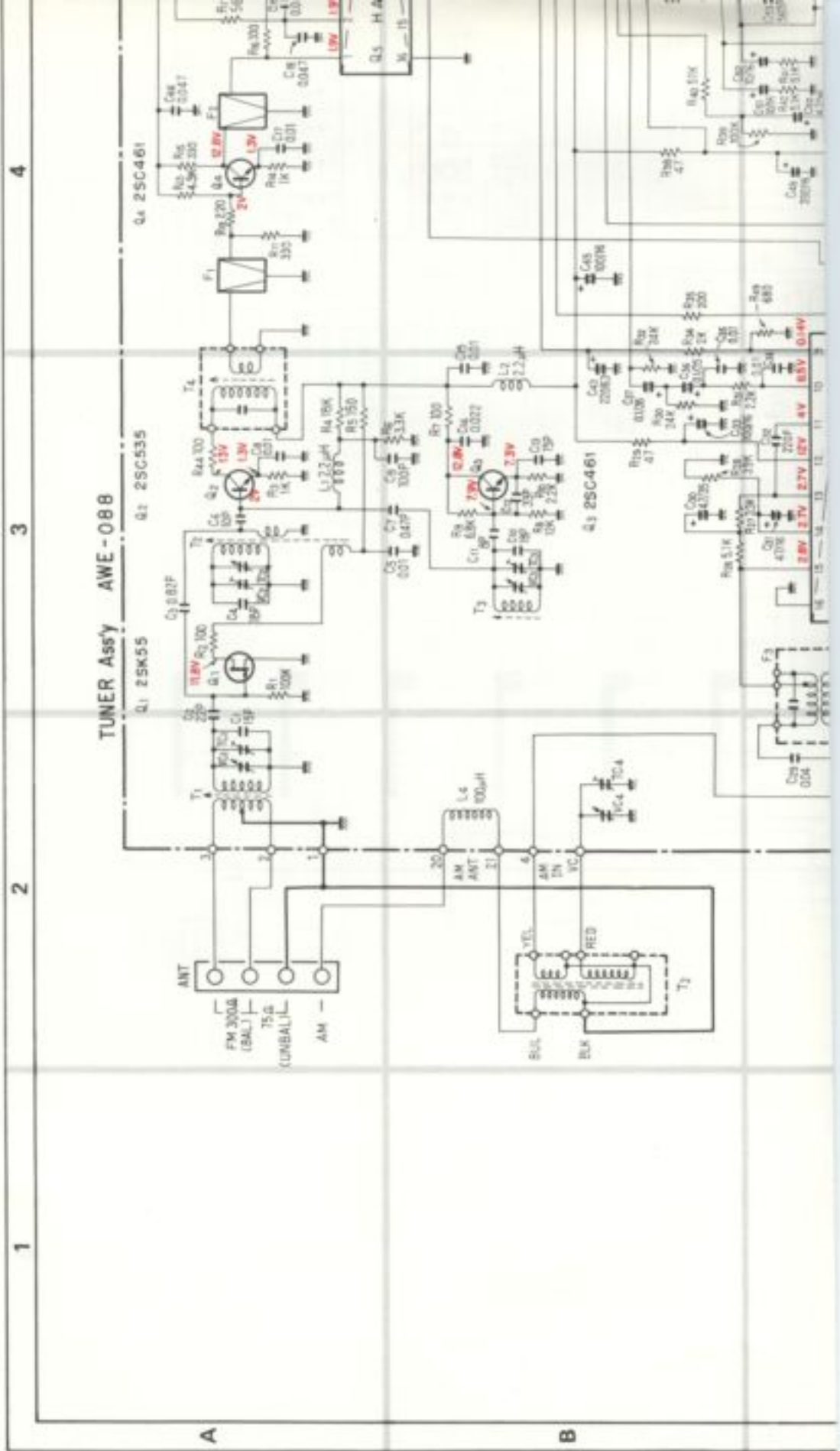

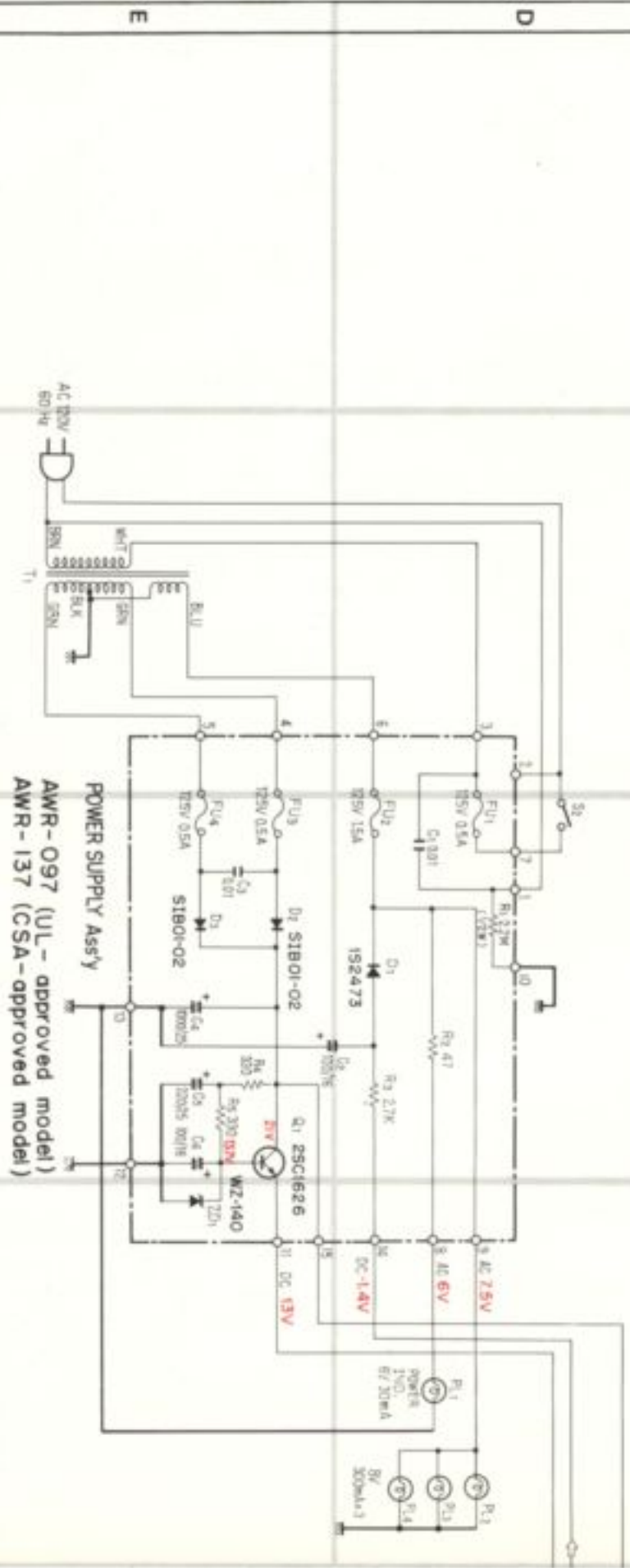
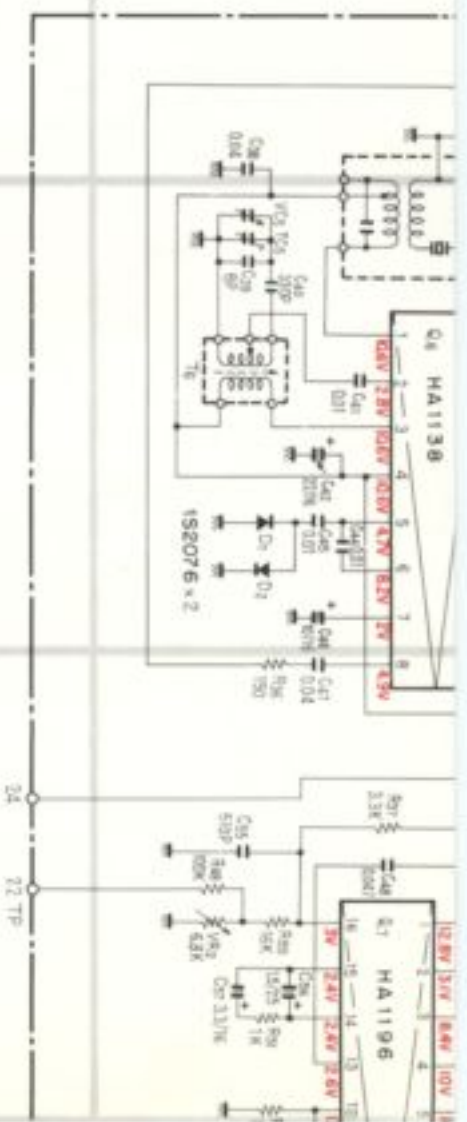

POWER SUPPLY Ass'y
 AWR-097 (UL - approved model)
 AWR-137 (CSA - approved model)

1 2 3 4

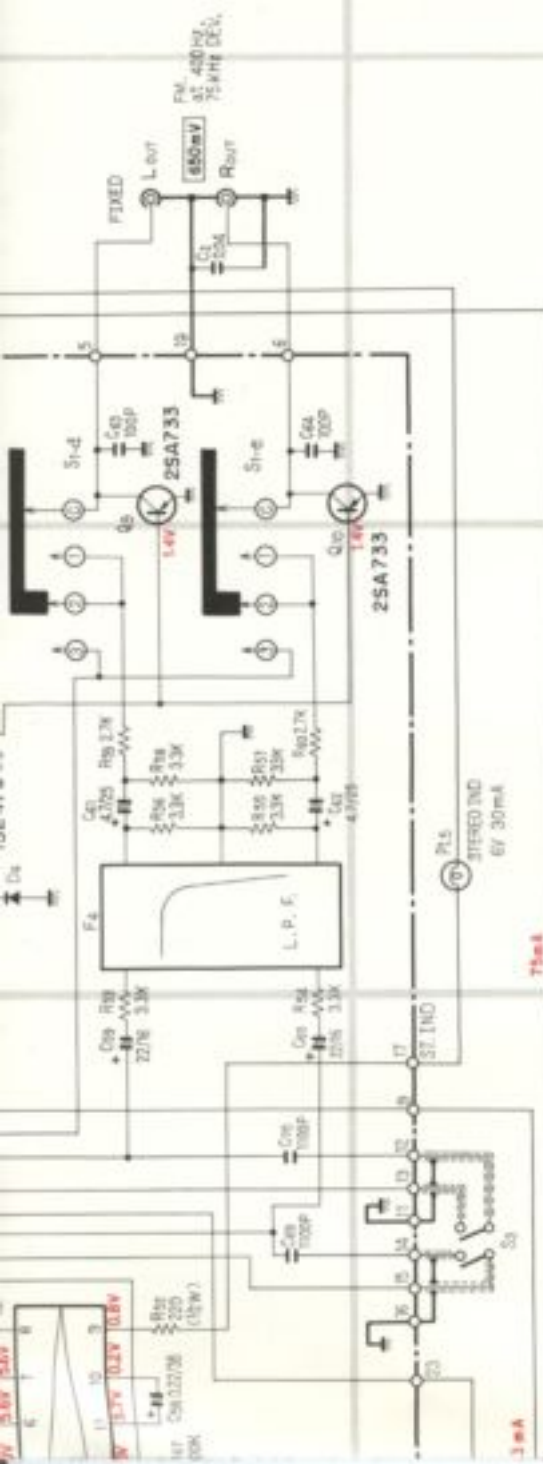

RESISTORS :
 IN OHM, 1/4 W., ± 5% TOLERANCE UNLESS
 OTHERWISE NOTED. K : KΩ M : MΩ

CAPACITORS :
 IN μF UNLESS OTHERWISE
 NOTED. P : pF

SWITCHES :
 S₁ FUNCTION
 1. FM MONO
 2. FM AUTO
 3. AM

S₂ POWER
 OFF - ON
 S₃ DF - EMPHASIS
 25 μS - 75 μS

⚡ DC CURRENT AT NO INPUT SIGNAL

C D E

5 6 7 8

PIONEER ELECTRONIC CORPORATION

4-1, Meguro 1-Chome, Meguro-ku, Tokyo 153, Japan

U.S. PIONEER ELECTRONICS CORPORATION

75 Oxford Drive, Moonachie, New Jersey 07074, U.S.A.

PIONEER ELECTRONIC (EUROPE) N.V.

Luitthagen-Haven 9, 2030 Antwerp, Belgium

PIONEER ELECTRONICS AUSTRALIA PTY. LTD.

178-184 Boundary Road, Braeside, Victoria 3195, Australia