

Operating Instructions

GRAPHIC EQUALIZER SG-50 (M)

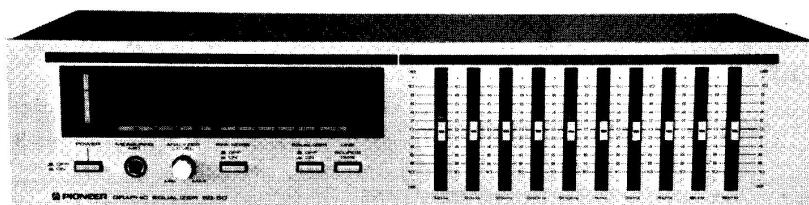

Thank you for buying this Pioneer product. Please read through these operating instructions and then you will know how to operate your model properly. After you have finished reading the instructions, put them away in a safe place for future reference. In accordance with the power and voltage requirements of differing areas, the following model names are used to designate models with differing electrical specifications.

Models	Line voltage
HE, HEM, NEM, HEZ, NE, NEZ	a.c. 220 volts ~
WE, WB, WP	a.c. 220 - 240 volts ~
S, S/G, SS	~AC 110/120/220/240 volts (Switchable voltage)
R, R/G	~AC 110 - 120/220 - 240 volts (Switchable voltage)
HB, HP, YB, YP	a.c. 240 volts ~
KU, KC	AC 120 volts

NOTES:

- The model names are stamped on the packing case.
- These operating instructions are prepared on the basis of the HEM model, and they can be used for other models. Although the design of the power plug and the power outlet shown may differ from the actual one, the operating procedures are the same.

[For KC model]

CAUTION: TO PREVENT ELECTRIC SHOCK DO NOT USE THIS (POLARIZED) PLUG WITH AN EXTENSION CORD, RECEPTACLE OR OTHER OUTLET UNLESS THE BLADES CAN BE FULLY INSERTED TO PREVENT BLADE EXPOSURE.

ATTENTION: POUR PREVENIR LES CHOCS ELECTRIQUES NE PAS UTILISER CETTE FICHE POLARISEE AVEC UN PROLONGATEUR UNE PRISE DE COURANT OU UNE AUTRE SORTIE DE COURANT, SAUF SI LES LAMES PEUVENT ETRE INSEREES A FOND SANS EN LAISSER AUCUNE PARTIE A DECOUVERT.

LINE VOLTAGE SELECTOR SWITCH

Only S and S/G models are provided with this switch but KU, KC and other models (HEM, HB, YP) are not provided with this switch.

Check that the indication of the line voltage selector switch is the same as your residence before plugging the power cord into the outlet. If it isn't on if you move to an area where the voltage requirements differ, change the switch setting as follows.

Before adjusting, disconnect the power cord.

1. Provide yourself with a medium size screwdriver.
2. Insert the screwdriver into the arrow on the voltage selector and adjust so that the tip of the arrow points to the voltage value of your area.

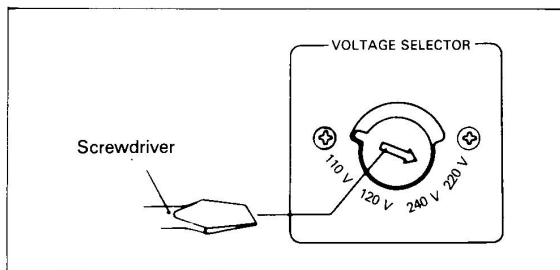

WARNING: TO PREVENT FIRE OR SHOCK HAZARD, DO NOT EXPOSE THIS APPLIANCE TO RAIN OR MOISTURE.

IMPORTANT NOTICE [For KU and KC models]

The serial number for this equipment is located on the rear panel. Please write this serial number on your enclosed warranty card and keep in a secure area. This is for your security.

CONTENTS

Connections	3	Combined Operation	8
System Connections	4	Troubleshooting	11
Front Panel Facilities	5	Specifications	11
Operating the Graphic Equalizer	6	Block Diagram	12



SAFETY INSTRUCTIONS

READ INSTRUCTIONS — All the safety and operating instructions should be read before the appliance is operated.

RETAIN INSTRUCTIONS — The operating instructions should be retained for future reference.

HEED WARNING — All warnings on the appliance and in the operating instructions should be adhered to.

FOLLOW INSTRUCTIONS — All operating and use instructions should be followed.

WATER AND MOISTURE — The appliance should not be used near water — for example, near a bathtub, washbowl, kitchen sink, laundry tub, in a wet basement, or near a swimming pool, etc.

LOCATION — The appliance should be installed in a stable location.

WALL OR CEILING MOUNTING — The appliance should not be mounted to a wall or ceiling.

VENTILATION — The appliance should be situated so that its location or position does not interfere with its proper ventilation. For example, the appliance should not be situated on a bed, sofa, rug, or similar surface that may block the ventilation openings; or, placed in a built-in installation, such as a bookcase or cabinet that may impede the flow of air through the ventilation openings.

HEAT — The appliance should be situated away from heat sources such as radiators, heat registers, stoves, or other appliances (including amplifiers) that produce heat.

POWER SOURCES — The appliance should be connected to a power supply only of the type described in the operating instructions or as marked on the appliance.

POWER-CORD PROTECTION — Power-supply cords should be routed so that they are not likely to be walked on or pinched by items placed upon or against them, paying particular attention to cords at plugs, convenience receptacles, and the point where they exit from the appliance.

POLARIZATION — If your purchased product is provided with a polarized power plug, please read the following instructions. This product is equipped

with a polarized alternating current line plug (a plug having one blade wider than the other). This plug will fit into the power outlet only one way. This is a safety feature. If you are unable to insert the plug fully into the outlet, try reversing the plug. If the plug should still fail to fit, contact your electrician to replace your obsolete outlet. Do not defeat the safety purpose of the polarized plug.

CLEANING — The appliance should be cleaned only with a polishing cloth or a soft dry cloth. Never clean with furniture wax, benzene, insecticides or other volatile liquids since they may corrode the cabinet.

POWER LINES — An outdoor antenna should be located away from power lines.

NONUSE PERIODS — The power cord of the appliance should be unplugged from the outlet when left unused for a long period of time.

OBJECT AND LIQUID ENTRY — Care should be taken so that objects do not fall and liquids are not spilled into the enclosure through openings.

DAMAGE REQUIRING SERVICE — The appliance should be serviced by Pioneer authorized service center or qualified service personnel when:

- The power-supply cord or the plug has been damaged; or
- Objects have fallen, or liquid has been spilled into the appliance; or
- The appliance has been exposed to rain; or
- The appliance does not appear to operate normally or exhibits a marked change in performance; or
- The appliance has been dropped; or the enclosure damaged.

SERVICING — The user should not attempt to service the appliance beyond that described in the operating instructions. For all other servicing, contact the nearest Pioneer authorized service center.

OUTDOOR ANTENNA GROUNDING — If an outside antenna is connected to the antenna terminal, be sure the antenna system is grounded so as to provide some protection against voltage surges and built up static charges.

In the U.S.A. section 810 of the National Electrical Code, ANSI/NEPA No. 70-1981, provides information with respect to proper grounding of the mast and supporting structure, grounding of the lead-in wire to an antenna discharge unit, size of grounding conductors, location of antenna-discharge unit, connection to grounding electrodes, and requirements for the grounding electrode. See Fig. A.

EXAMPLE OF ANTENNA GROUNDING AS PER NATIONAL ELECTRICAL CODE INSTRUCTIONS

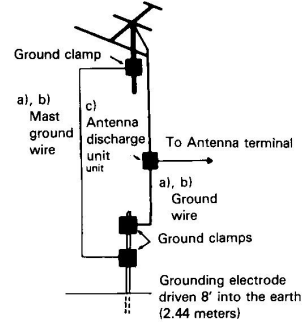

Fig. A

- a) Use No. 10 AWG (5.3 mm²) copper or No. 8 AWG (8.4 mm²) aluminum or No. 17 AWG (1.0 mm²) copper-clad steel or bronze wire, or larger as ground wires for both mast and lead-in.
- b) Secure lead-in wire from antenna to antenna discharge unit and mast ground wire to house with stand-off insulators, spaced from 4 feet (1.22 meters) to 6 feet (1.83 meters) apart.
- c) Mount antenna discharge unit as closely as possible to where lead-in enters house.

IMPORTANT 1



The lightning flash with arrowhead, within an equilateral triangle, is intended to alert the user of the presence of uninsulated "dangerous voltage" within the product's enclosure that may be of sufficient magnitude to constitute a risk of electric shock to persons.



CAUTION:
TO PREVENT THE RISK OF ELECTRIC SHOCK, DO NOT REMOVE COVER (OR BACK). NO USER-SERVICEABLE PARTS INSIDE. REFER SERVICING TO QUALIFIED SERVICE PERSONNEL.



The exclamation point within an equilateral triangle is intended to alert the user of the presence of important operating and maintenance (servicing) instructions in the literature accompanying the appliance.

IMPORTANT 2

If the apparatus is fitted with AC main power outlet(s), see REAR PANEL FACILITIES for convenient connection of additional Hi-Fi component(s). Make all connections to the AC outlet(s) and the signal terminals first. Connect the plug to the wall socket last, make sure that the power switch is off. Disconnect the wall plug when the equipment is not in regular use, e.g. when on vacation.

FOR USE IN THE UNITED KINGDOM AND AUSTRALIA

CAUTION 240 V: Mains supply voltage is factory adjusted at 240 V.

FOR USE IN THE UNITED KINGDOM

WARNING: This plug must only be connected to electronic apparatus equipped with suitable sockets. Otherwise cut off and dispose of the plug, and fit an appropriate one in accordance with the instruction below.

The wires in this mains lead are coloured in accordance with the following code:

Blue: Neutral
Brown: Live

As the colours of the wires in the mains lead of this apparatus may not correspond with the coloured marking identifying the terminals in your plug proceed as follows:

The wire which is coloured blue must be connected to the terminal which is marked with the letter N or coloured black.

The wire which is coloured brown must be connected to the terminal which is marked with the letter L or coloured red.

CONNECTIONS

The figure shows an example of the connections when the unit is used in combination with the SA-950 stereo amplifier. Use the tape terminals when the unit is used in combination with any stereo amplifier except that used in PIONEER's stereo system components.

NOTE:
For details, refer to the Operating Instructions of your stereo amplifier.

The following accessories are supplied:

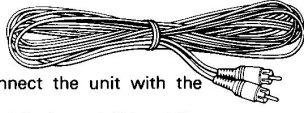
Two pin plug cords 
These are used to connect the unit with the stereo amplifier.
The white plug is for the left channel (L) and the red plug is for the right channel (R).

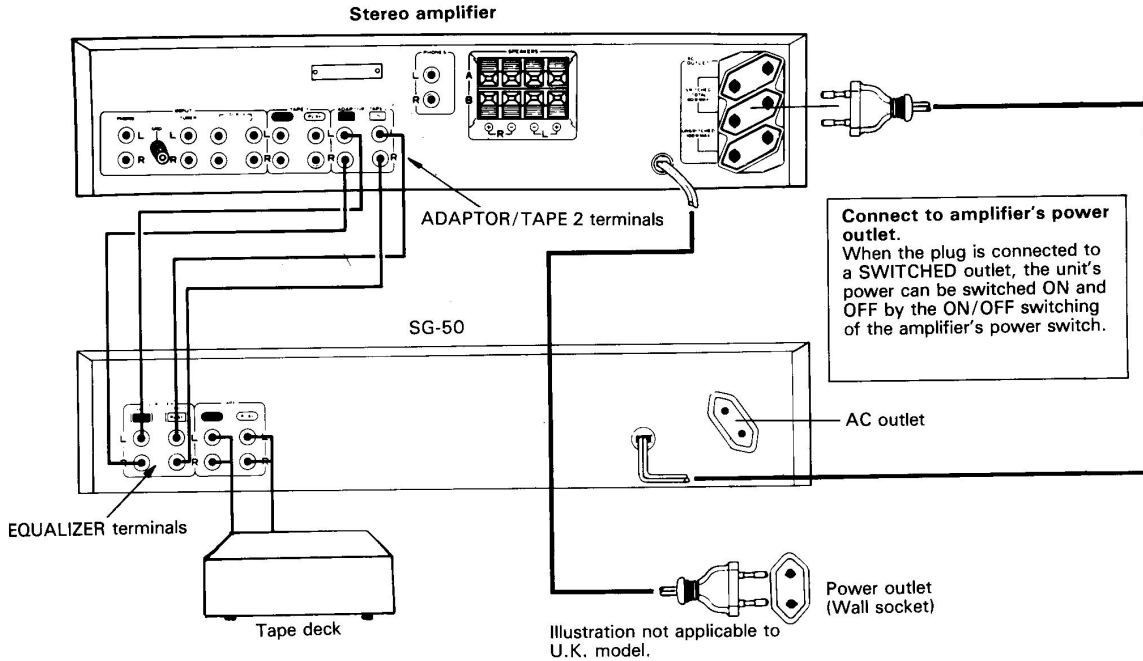

TAPE TERMINAL APPLICATIONS

- Use the TAPE terminals when connecting a tape deck or when connecting an adaptor such as a micmixing amplifier.

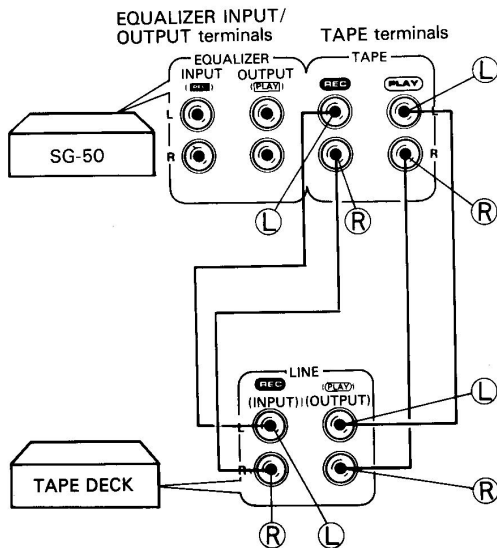

AC OUTLET (UNSWITCHED)

Power flows continually to this outlet, regardless of whether the amplifier is switched ON or OFF. Electrical power consumption of the connected equipment should not exceed 100 W.

The equipment should be disconnected by removing the mains plug from the wall socket when not in regular use, e.g. when on vacation.

NOTE:
Do not connect appliances with high power consumption such as heaters, irons, or television sets to the AC OUTLETS in order to avoid overheating or fire risk.
This can cause the amplifier to malfunction.

The YP model is not equipped with an auxiliary AC outlet.

SYSTEM CONNECTIONS

Make sure that the antenna is connected whenever you are listening to radio broadcasts.

This illustration is an example of the connections made when using the SG-50M in conjunction with PIONEER's stereo components. For details, consult the Operating Instructions of the respective components.

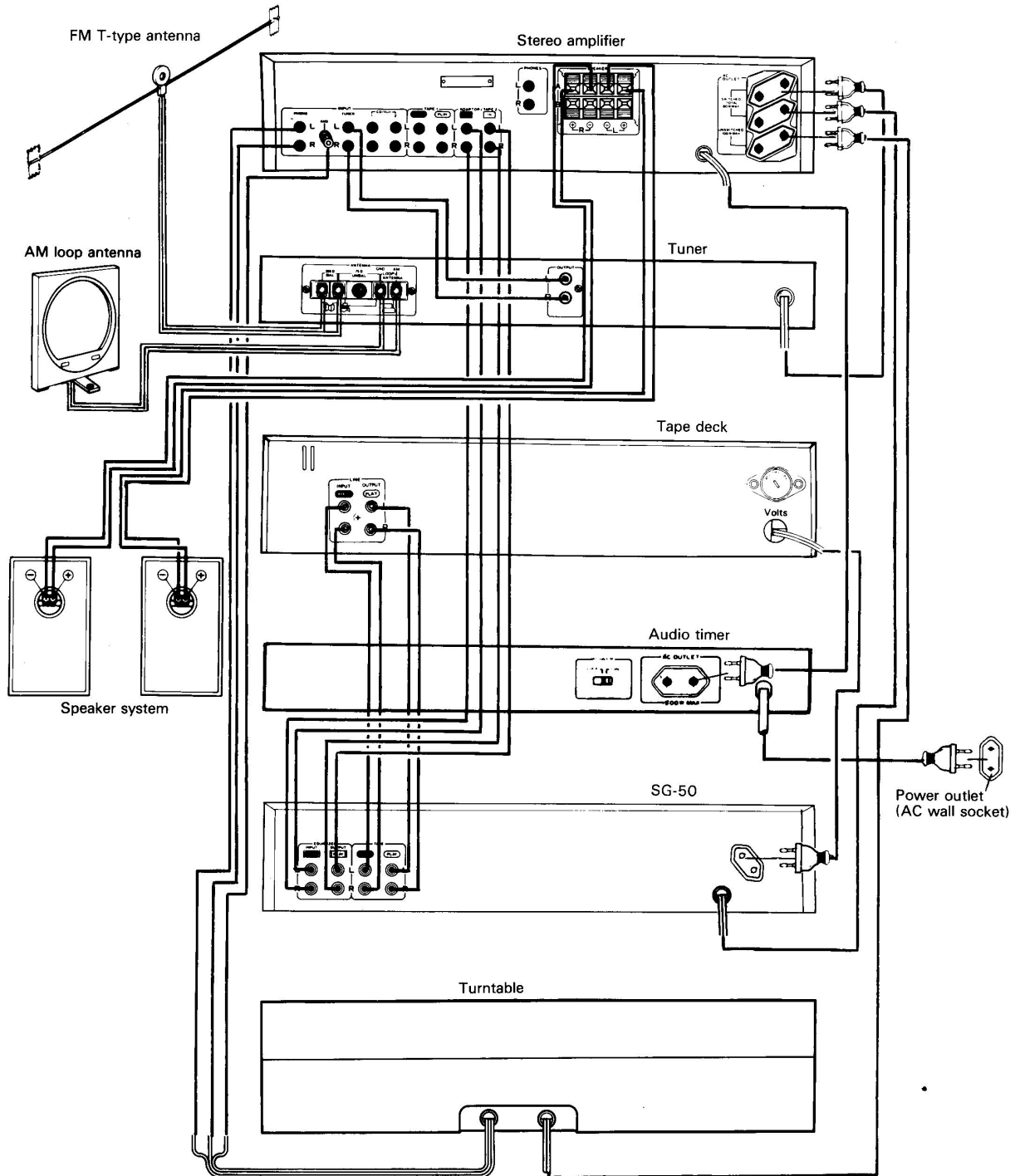

FRONT PANEL FACILITIES

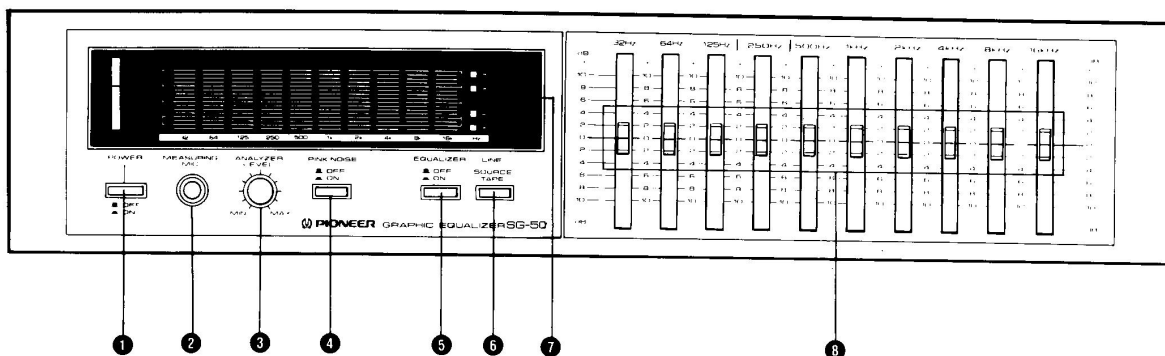

1 POWER SWITCH (POWER)/INDICATOR

When this switch is set to the ON position, power is supplied to the unit's main circuits.

Disconnect the power cord from the power outlet when you do not plan to use the unit for a long period of time.

2 MEASURING MIC JACK

Connect the room acoustics monitor microphone CM-75M to this jack. Plug the miniplug of the connecting cord into the back of the CM-75M, and the 6 mm standard plug into the MIC JACK of the unit. For microphone installation, refer to the operating instructions for the CM-75M.

3 ANALYZER LEVER CONTROL

This control adjusts the sensitivity of the analyzer. Adjust as follows so that the amplitude of the analyzer indicator is satisfactory.

When measuring room acoustics

Adjust such that the average amplitude level is near 0 dB on the indicator.

When compensating for room acoustics, adjust the octave control such that the amplitude of the analyzer indicator is flat overall.

When compensating for the program source (broadcasts, records)

Adjust such that the overall amplitude is near 0 dB.

4 PINK NOISE SWITCH

Use this switch for measuring the room acoustics. When the CM-75M is connected and installed, and this switch is set to ON, a pink noise used for measurements is generated and emitted by the speakers. This noise is picked up by the microphone and displayed on the analyzer indicator.

The pink noise has flat characteristics over the entire frequency range, and the indicator therefore shows how this changes with the room conditions.

5 EQUALIZER SWITCH

This switch is pressed to compensate for the frequency response of the signals entering the EQUALIZER INPUT and TAPE PLAY terminals. The compensated signals are then output as the output signals from the EQUALIZER OUTPUT terminals, and the compensated signals are output from both the EQUALIZER OUTPUT terminals and TAPE REC terminals.

6 LINE (SOURCE/TAPE) SWITCH

Press this switch (TAPE position) when using a stereo component connected to the rear panel TAPE terminals. At all other times, ensure that the switch is at the released position (SOURCE position).

7 ANALYZER INDICATOR

Shows the variation of signal level over each frequency band by means of an F.L. tube.

This can be used to check frequencies during ordinary playback of the program source, or when measuring or compensating for room acoustics.

8 OCTAVE CONTROLS

Move these controls above or below the center (zero) position to boost or attenuate the corresponding frequency band. The ten frequency bands are centered at 32 Hz, 64 Hz, 125 Hz, 250 Hz, 500 Hz, 1 kHz, 2 kHz, 4 kHz, 8 kHz and 16 kHz.

The indicator of each control serves as a guideline for the changes in the frequency response.

OPERATING THE GRAPHIC EQUALIZER

The graphic equalizer divides the music source into a number of frequency bands and boosts or attenuates the level at each of the frequencies, enabling much finer sound quality adjustments than ordinary tone controls and sound field compensation.

Some examples of operation are given below.

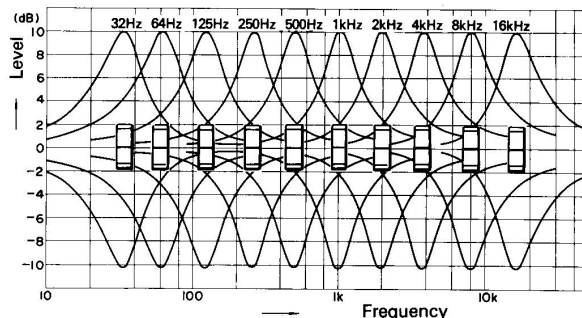
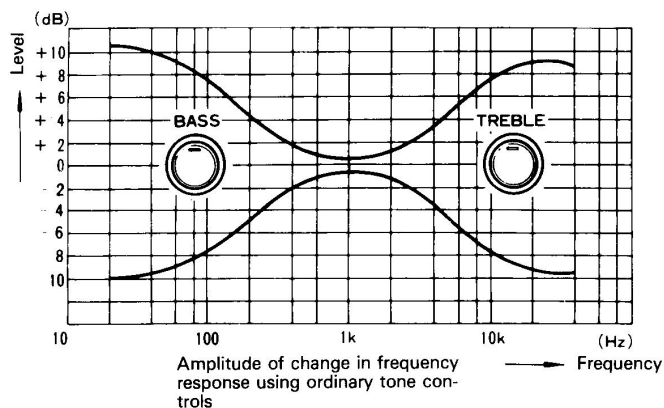

1 COLORING THE REPRODUCED SOUND

All instruments and vocals have their own frequency band, as shown in the figure.

By moving the controls up or down, the volume of the instruments preferred can be boosted or other instruments can be attenuated.

For instance, it is possible to boost the 60 Hz frequency and give the bass drum and greater "punch" or boost the 1 kHz frequency and position the vocals at the front. When the 8 kHz frequency is boosted, the cymbals and "high hat" sound much clearer. Instruments and vocals have a great many harmonic components along with the fundamental frequency band and so you can have lots of fun operating the 10 controls to achieve the sound of your choice.

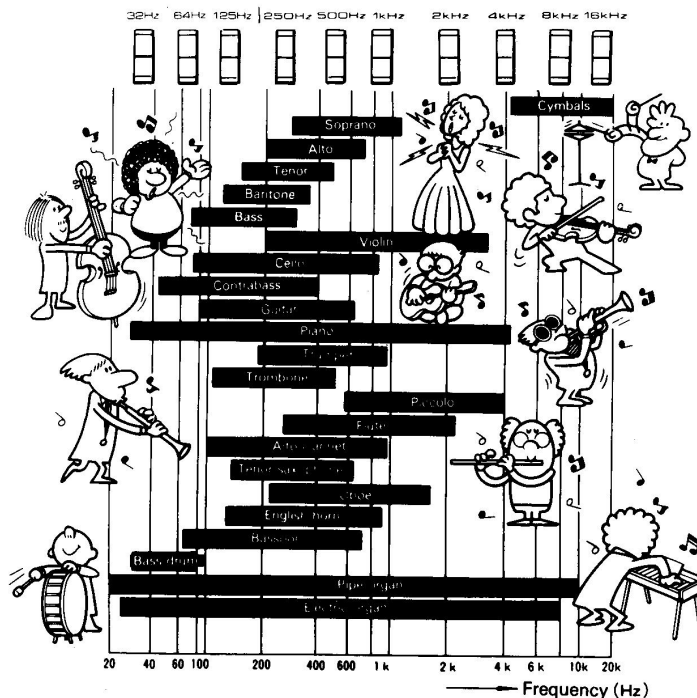

2 COMPENSATING FOR THE PLAYBACK FREQUENCY RESPONSE

The frequency response of a phono-cartridge or speaker has peaks and dips in the high range and low range. It can be made flat by finely adjusting the controls on the graphic equalizer.

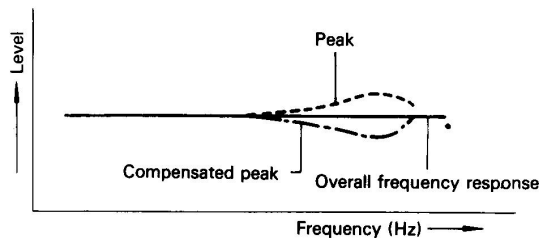

IMPROVING THE ACOUSTICS OF THE LISTENING ROOM

The ideal listening room is one where the transmission frequency response is flat. In actual fact, however, the acoustics vary depending on the effects of the structure of the room and its furniture and on the listening position.

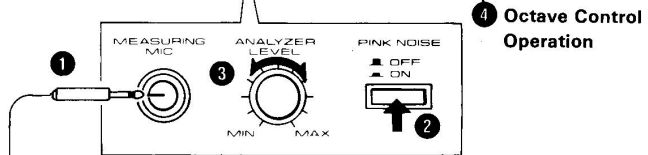
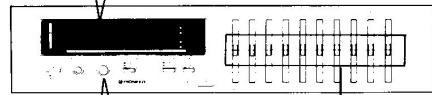
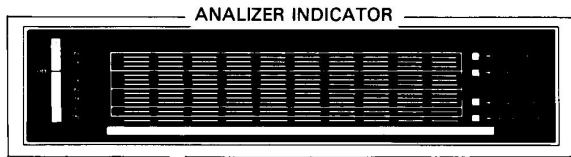
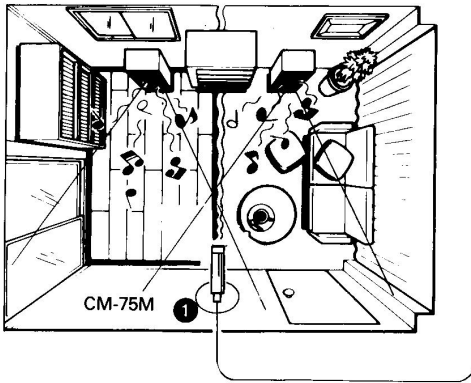

Acoustics Adjustments

- 1 Set up the microphone (CM-75M) at your normal listening position. Connect the microphone plug to the MEASURING MIC jack.
- 2 Set the PINK NOISE switch to ON.
- 3 Adjust the volume of the premain amplifier to your normal listening level.
- 4 Adjust the analyzer level so that the average level of the analyzer indicator stays around the 0 dB level.
- 5 Adjust the octave control so that the overall frequency response becomes average.

3 RECORDING TECHNIQUES USING GRAPHIC EQUALIZER

Coloring the sound of vocals or instruments

The sound of vocals and instruments can be colored at will by operating the controls. For instance, when the 500, 1 k and 2 k controls are raised and the other controls lowered, people's voices sound as if heard on a telephone.

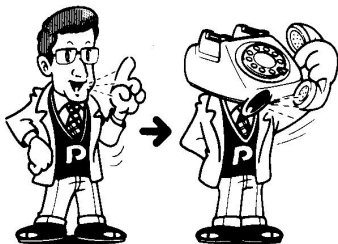

Preventing howl during mixing play

Any irritating howl during play can be prevented by lowering the knob corresponding to the frequency band in which the howl occurs.



Noise can be reduced during recording and playback

When the high-range controls are boosted in step fashion during recording and then lowered in reverse fashion during playback, tape hiss and other high-range noise can be reduced.

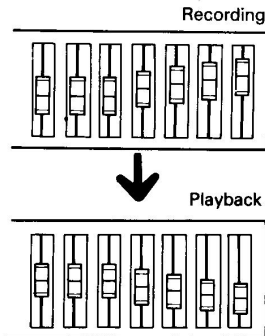

Creating recorded tapes most compatible with the playback equipment

A sound with a greater "punch" can be recorded for playback on car stereo equipment if the ultra-low-range, which is hard to hear, is cut out and the mid-range is boosted.

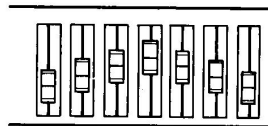

COMBINED OPERATION

■ Tape recording a record program or radio broadcast with equalizer compensation added.

Operate in the numerical sequence

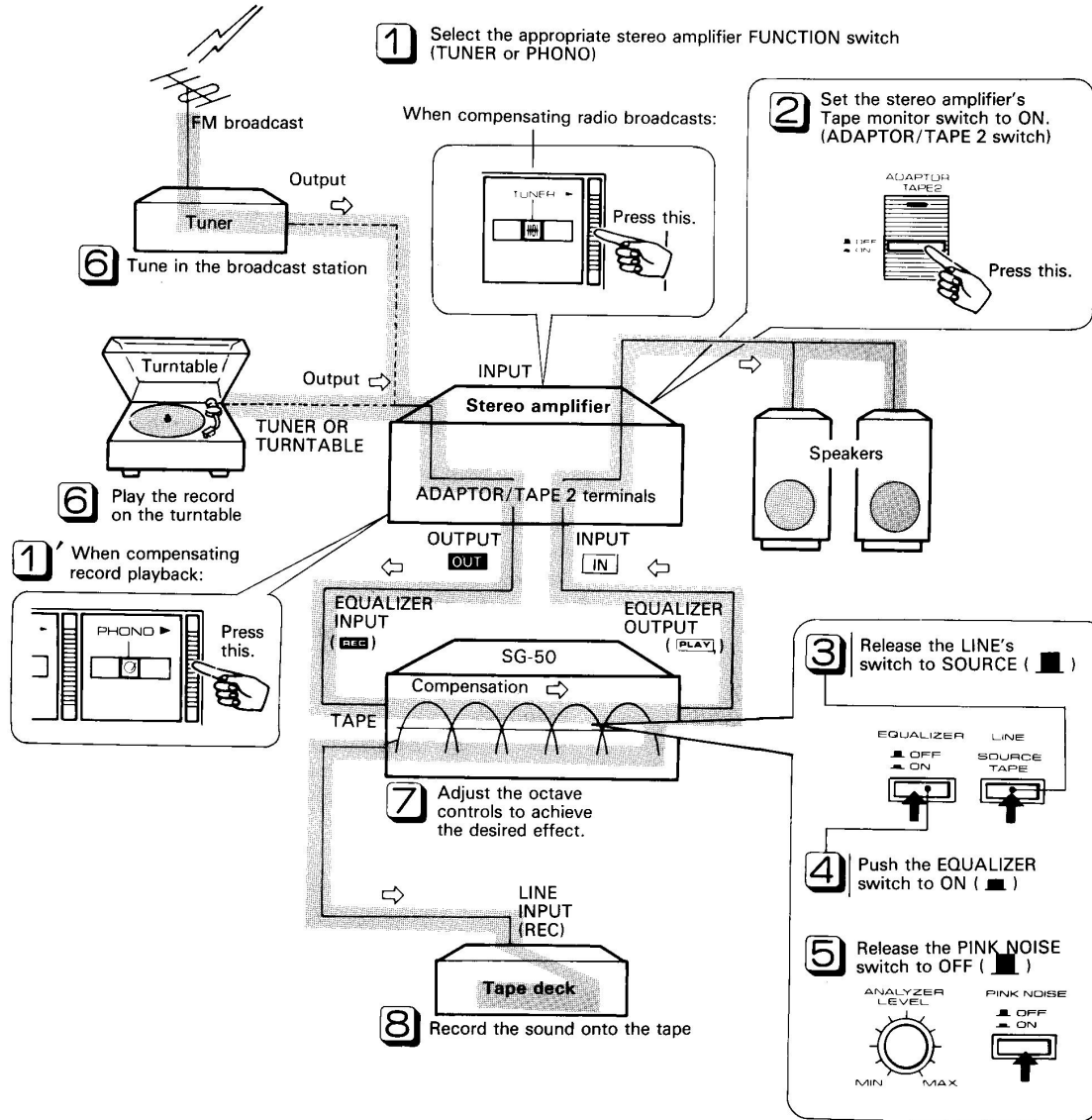

When recording without adding equalizer effects and when monitoring the program source. Release the EQUALIZER switch to OFF.

Recordings made from radio broadcasts, records or other material may be used for personal enjoyment but may not be used in a way which will infringe the rights of copyright owners and be contrary to law.

■ Compensating tape playback with equalizer effects

Operate in the numerical sequence.

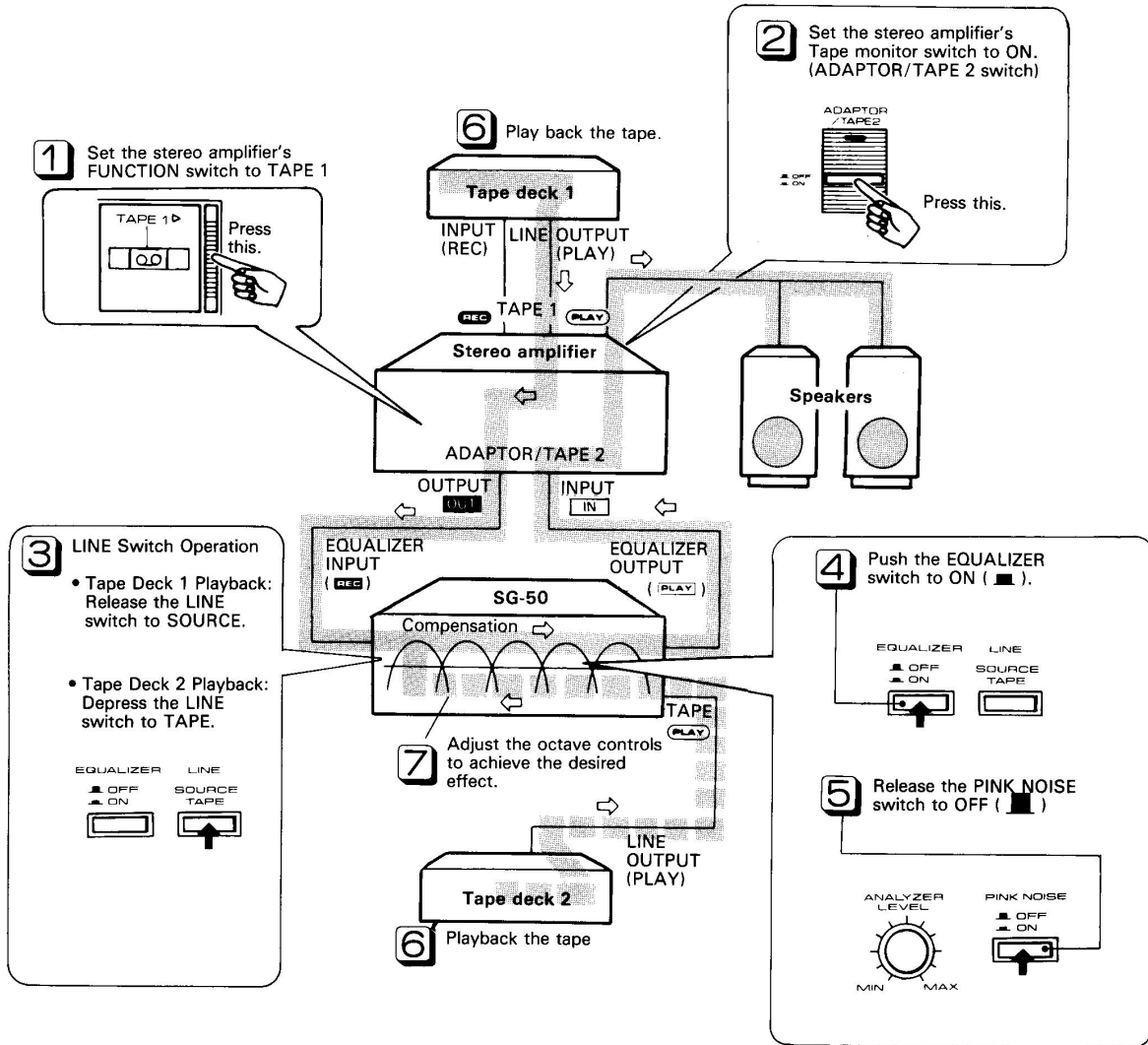

When recording without adding equalizer effects and when monitoring the program source. Release the EQUALIZER switch to OFF.

COMBINED OPERATION

■ Performing tape editing with equalizer

When copying from tape deck 1 to tape deck 2 while equalizing.

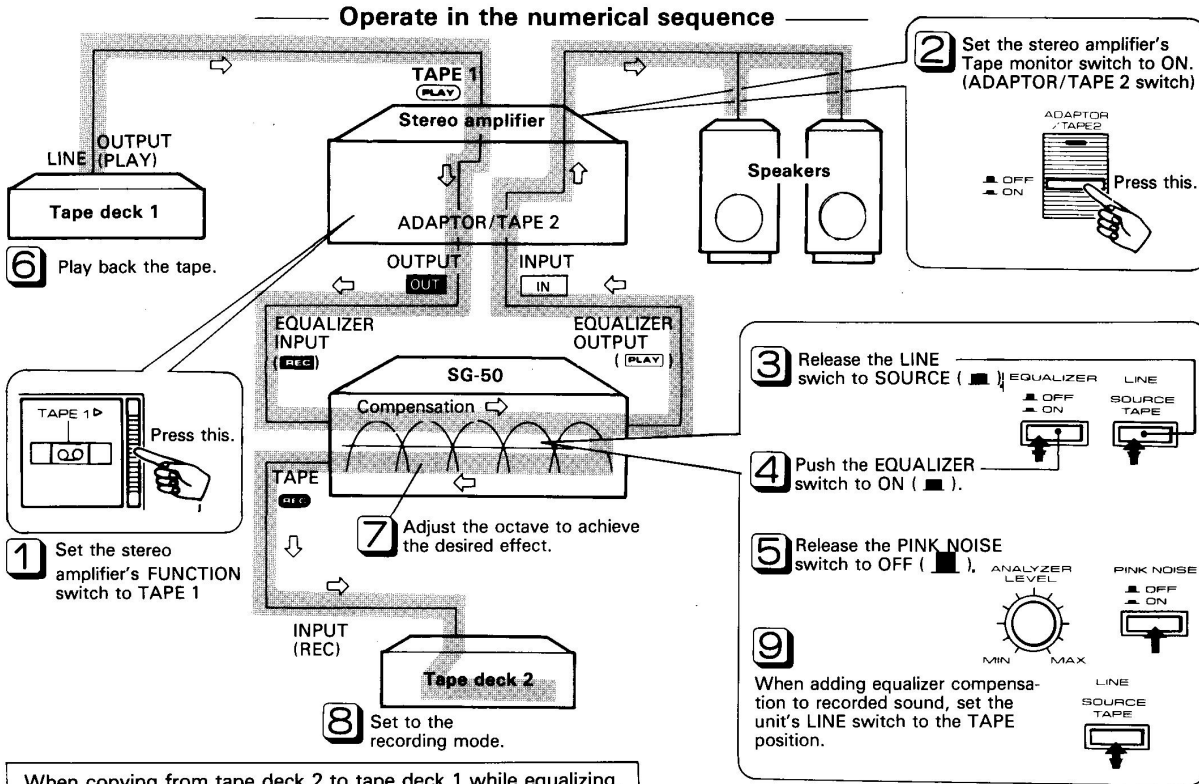

When copying from tape deck 2 to tape deck 1 while equalizing.

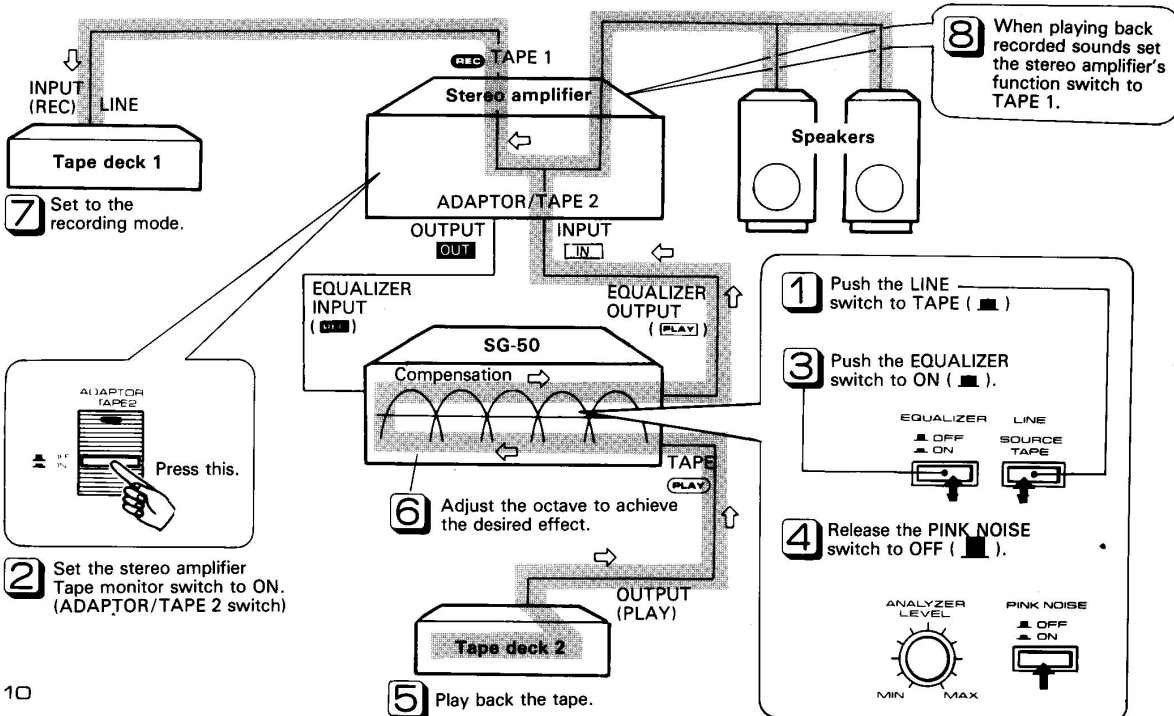

TROUBLESHOOTING

If you think that the unit is malfunctioning, perform the following checks. Often incorrectly following the operating procedures are to blame. The cause may also lie outside the unit itself. Check the other components and electrical appliances being used at the same time.

If the problem is not remedied after the following the checklist below, contact your dealer or the nearest Pioneer Service.

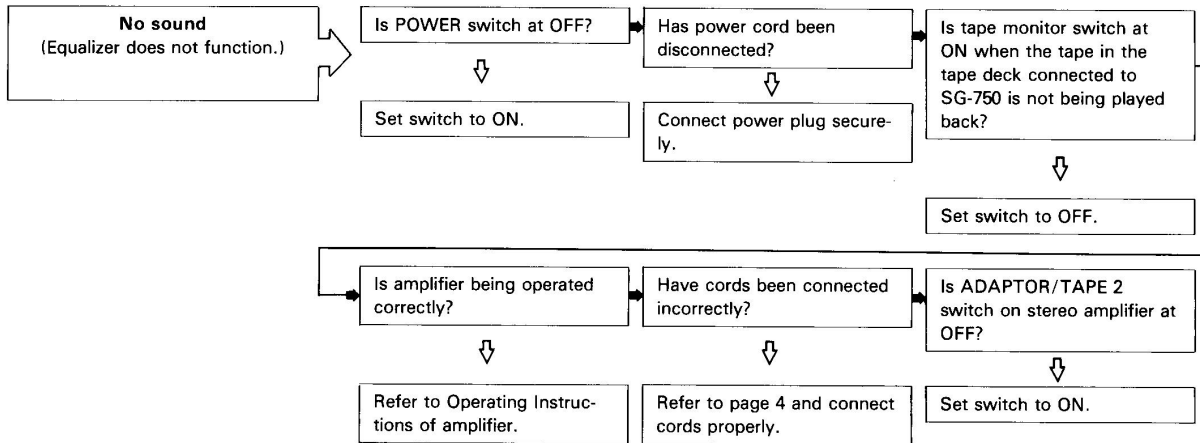

SPECIFICATIONS

Graphic Equalizer Section

Equalizer Range	
Individual channel controls	±10 dB
Center frequencies	
32 Hz, 64 Hz, 125 Hz, 250 Hz, 500 Hz, 1 kHz, 2 kHz, 4 kHz, 8 kHz, 16 kHz	
Total Harmonic Distortion	
(All controls at flat position, 2 V output) 1 kHz	0.003%
20 Hz to 20 kHz	0.003%
Gain (all controls at flat position)	0 dB
Maximum Output Voltage	
1 kHz, 0.01% THD, 50 kΩ RL	6 V
Frequency Response	5 Hz to 100 kHz ±3 dB
Signal-to-Noise Ratio	
(IHF A network, shot-circuited, 2 V output)	116 dB
Input terminal (Sensitivity/Impedance)	
INPUT	150 mV/50 kΩ
TAPE PLA.	150 mV/50 kΩ
Output terminal (Level/Impedance)	
OUTPUT	150 mV/1 kΩ
TAPE REC	150 mV
Spectrum Analyzer Section	
Center frequencies	
32 Hz, 64 Hz, 125 Hz, 250 Hz, 500 Hz, 1 kHz, 2 kHz, 4 kHz, 8 kHz, 16 kHz	
Resolution	3 dB step, 8 point

Power Supply Section/Miscellaneous

Power Requirements	
KU, KC models	AC 120 Volts, 60 Hz
S, S/G models	
	~AC 110 V/120 V/220 V/240 V switchable, 50/60 Hz
HB and YP models	a.c. 240 Volts ~, 50/60 Hz
HEM models	a.c. 220 Volts ~, 50/60 Hz
Power Consumption	16 Watts
Dimensions	420 (W) x 98 (H) x 266 (D) mm 16-9/16 (W) x 3-7/8 (H) x 10-1/2 (D) in
Weight	4.4 kg (9 lb 11 oz)

Furnished Parts

Connection cords with pin plugs	2
Operating Instructions	1
Measuring microphone CM-75M	1 set

NOTE:

Specifications and design subject to possible modification without notice due to improvements.

BLOCK DIAGRAM

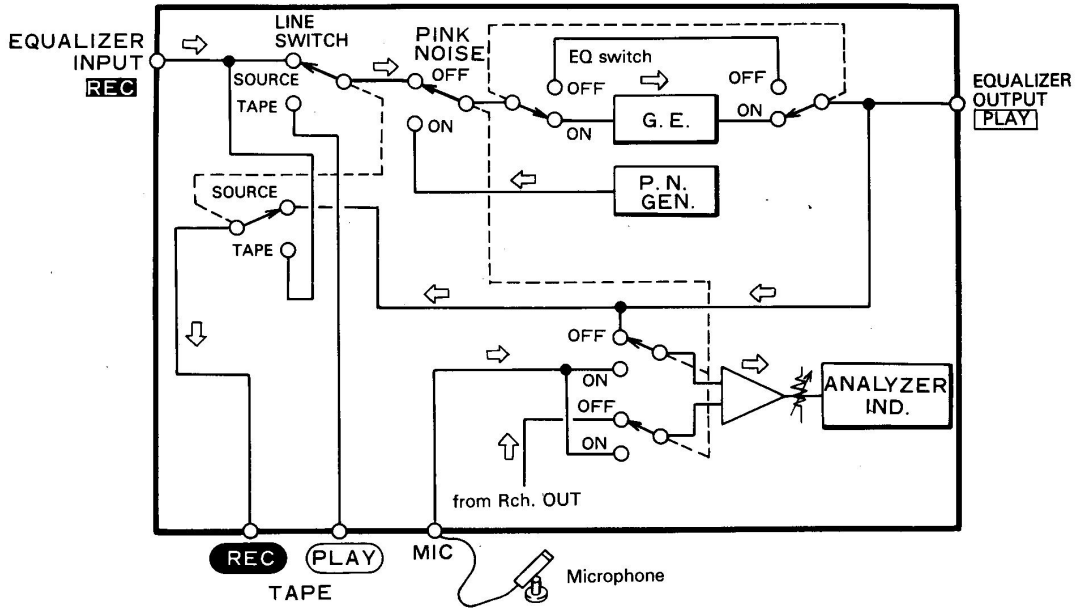

PIONEER ELECTRONIC CORPORATION 4-1, Meguro 1-Chome, Meguro-ku, Tokyo 153, Japan
PIONEER ELECTRONICS (USA) INC. P.O. Box 1760, Long Beach, California 90801 U.S.A.
 TEL: (800) 421-1404, (800) 237-0424
PIONEER ELECTRONIC (EUROPE) N.V. Keetbergplein 1, 2740 Beveren, Belgium TEL: 03/775-28-08
PIONEER ELECTRONICS AUSTRALIA PTY. LTD. 178-184 Boundary Road, Braeside, Victoria 3195, Australia
 TEL: (03) 580-9911