

STEREO AMPLIFIER

SA-7500II

SERVICE MANUAL



 PIONEER

MODEL SA7500II COMES IN FOUR VERSIONS DISTINGUISHED AS FOLLOWS:

Type	Voltage	Remarks
KU	120V only	UL (U.S.A.) approved
KC	120V only	CSA (Canada) approved
HG	220V and 240V (Switchable)	SEMKO (Sweden), NEMKO (Norway), DEMKO (Denmark) and EI (Finland) approved
S	110V, 120V, 220V and 240V (Switchable)	General export model

This service manual is applicable to the KU-type. When repairing the KC-type, HG-type or S-type, please see the additional service manual.

CONTENTS

1.	SPECIFICATIONS	2
2.	FRONT PANEL FACILITIES	3
3.	CONNECTION DIAGRAM	5
4.	BLOCK DIAGRAM	6
5.	LEVEL DIAGRAM	6
6.	CIRCUIT DESCRIPTIONS	
6.1	AF Section	7
6.2	Protection Circuit	8
6.3	Power Supply Circuit	9
7.	DISASSEMBLY	10
8.	PARTS LOCATION	
8.1	Front Panel View	12
8.2	Rear Panel View	13
8.3	Front View with Panel Removed	14
8.4	Top View	15
9.	ADJUSTMENT	16
10.	EXPLODED VIEW	17
11.	SCHMATIC DIAGRAMS, P.C. BOARD PATTERNS AND PARTS LIST	
11.1	Miscellanea	24
11.2	Schematic Diagram	25
11.3	Control Amplifier Assembly (AWG-047)	27
11.4	AF Amplifier Assembly (AWK-079)	30
12.	PACKING	36

1. SPECIFICATIONS

Semiconductors

ICs	2
Transistors	26
Diodes	17

Power Amplifier Section

Circuitry 2-stage differential amplifier Parallel
PP direct-coupled OCL

Continuous Power Output from 20 Hertz to 20,000 Hertz
(Both channels driven) . . . 45 watts per channel (8 ohms)
50 watts per channel (4 ohms)

Total Harmonic Distortion at 20 Hertz to 20,000 Hertz from
AUX

Continuous rated power output	0.1%
25 watts per channel power output, 8 ohms	0.05%
1 watt per channel power output, 8 ohms	0.05%

Intermodulation Distortion

Continuous rated power output	0.1%
25 watts per channel power output, 8 ohms	0.05%
1 watt per channel power output, 8 ohms	0.05%

Speakers A, B, A + B

Headphones Low impedance

Damping Factor (20 Hertz to 20,000 Hertz, 8 ohms) . . . 30

Input (Sensitivity/Impedance)

PHONO	2.5mV/50kohms
TUNER	150mV/50kohms
AUX	150mV/50kohms
TAPE PLAY 1	150mV/50kohms
TAPE PLAY 2	150mV/50kohms

PHONO Overload Level (T.H.D. : 0.1%) : 200mV (1kHz)

Output (Level/Impedance)

TAPE REC 1	150mV
TAPE REC 2	150mV

Frequency Response

PHONO (RIAA Equalization)	20Hz to 20,000Hz ±0.3dB
TUNER, AUX, TAPE PLAY	10Hz to 40,000Hz ±1dB

Tone Control

BASS	+9dB, -8dB (100Hz)
TREBLE	+8dB, -6dB (10kHz)

Filter

LOW 15Hz (6dB/oct.)

Loudness Contour (Volume control set at -40dB position)
. +6dB (100Hz), +3dB (10kHz)

Hum and Noise (100Hz, short-circuited, A network, rated
power)

PHONO	73dB
TUNER, AUX, TAPE PLAY	95dB

Miscellaneous

Power Requirements 120V 60Hz only

Power Consumption 135watts (UL)
200VA (CSA), 400watts (Max.)

Dimensions 380(W) x 139(H) x 308(D)mm
15(W) x 5-1/2(H) x 12-1/8(D)in.

Weight Without Package: 9.1kg (20lb 1oz)
With Package: 10.1kg (22lb 4oz)

Furnished Parts

Operating Instructions	1
Connection Cord with Pin Plugs	1
Hex. Wrench (Used for fastening Volume knob)	1

NOTE:

Specifications and the design subject to possible modification without notice due to improvements.

2. FRONT PANEL FACILITIES

LOW FILTER SWITCH

When set to 15Hz (lower) position, frequencies below 15Hertz are attenuated by 6dB/octave. This permits reduction of ultra low frequency noise due to physical distortion of the record disc or other causes. Although such noise is inaudible to the human ear, it can be both detrimental to the speaker systems and contribute to intermodulation distortion. Setting the switch to 15Hz position is an effective measure if the record contains cutting noise.

POWER SWITCH

Set to ON position to energize SA-7500II. After setting to ON, there is a brief delay before sound is obtained. This is due to the operation of the muting circuit which prevents noise when the POWER is switched. This function does not indicate difficulty and normal operation condition is attained in a few seconds. The POWER switch also controls the rear panel SWITCHED convenience outlets.

PHONES JACK

When listening with stereo headphones, connect them to this jack.

NOTE:

Set **SPEAKERS** switch to OFF when listening only with headphones.

TONE SWITCH

In the ON position, tone adjustments can be performed with the BASS and TREBLE controls. When set to the upper (OFF) position, the tone control circuits are disengaged and frequency response is flat. This function is convenient for checking cartridge and speaker tone quality and listening room acoustics.

BASS AND TREBLE CONTROLS

Controls for adjusting low and high frequency tone. With the TONE switch in the ON position, turn controls clockwise to enhance low or high frequencies and counter-clockwise to attenuate their respective frequency ranges.

SPEAKERS SWITCH

Selects speaker system operation.

OFF: Sound not obtained from speakers (when using headphones).

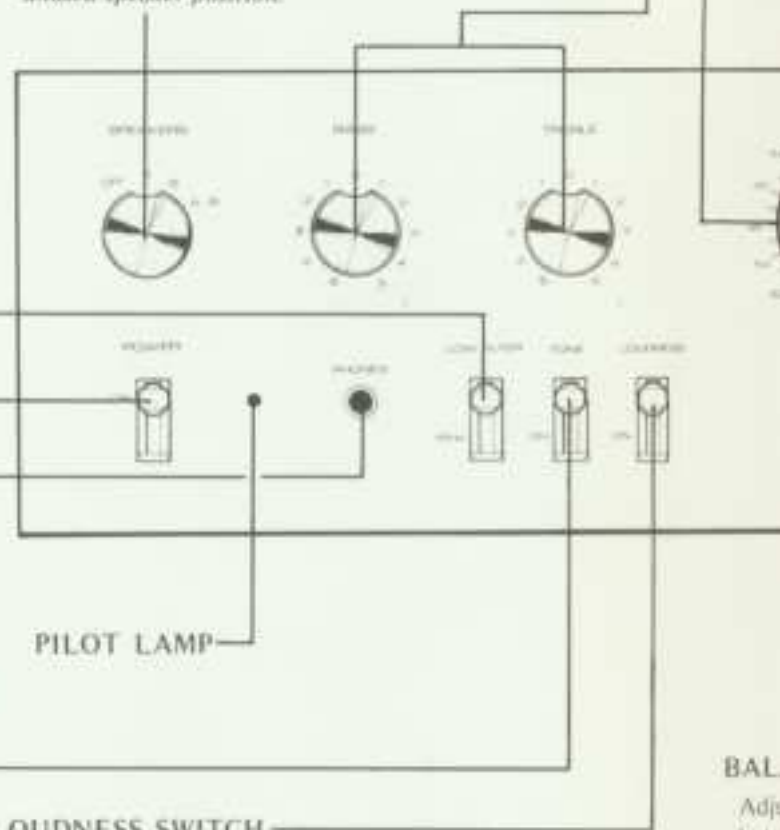
A: Sound obtained from speakers connected to A speaker terminals.

B: Sound obtained from speakers connected to B speakers terminals.

A + B: Sound obtained from speakers connected to both A and B speaker terminals.

NOTE:

When listening with headphones or to temporarily interrupt the speaker sound, set switch to OFF or to an unused speaker position.



LOUDNESS SWITCH

When listening at low volume settings, set switch to ON to enhance low and high frequencies. The response of the human ear to sound differs according to loudness. This switch compensates for this effect at low volumes.

VOL

Adj
att
arb
volu

MOD

Sele
STE
MOR

BAL

Adj
betw
char
from
insu
cent

ny tone. With
turn controls
s and counter-
frequency ranges.

rs (when using

connected to A

connected to B

connected to

mparily inter-
OFF or to an

VOLUME CONTROL

Adjusts speaker and headphone volume. Scale indicates attenuation in dB with maximum volume assigned an arbitrary value of 0dB. Clockwise rotation increases volume.

MODE SWITCH

Selects stereo or mono playback modes.

STEREO: Stereo reproduction

MONO: Left and right channel signals are mixed and reproduced monophonically.

FUNCTION SWITCH

Selects desired playback program source.

PHONO: To play records on a turntable connected to the PHONO jacks.

TUNER: To listen to broadcasts with a tuner connected to the TUNER jacks.

AUX: To play a component connected to the AUX jacks.

TAPE MONITOR SWITCH

Employ for tape playback or to monitor a recording in progress.

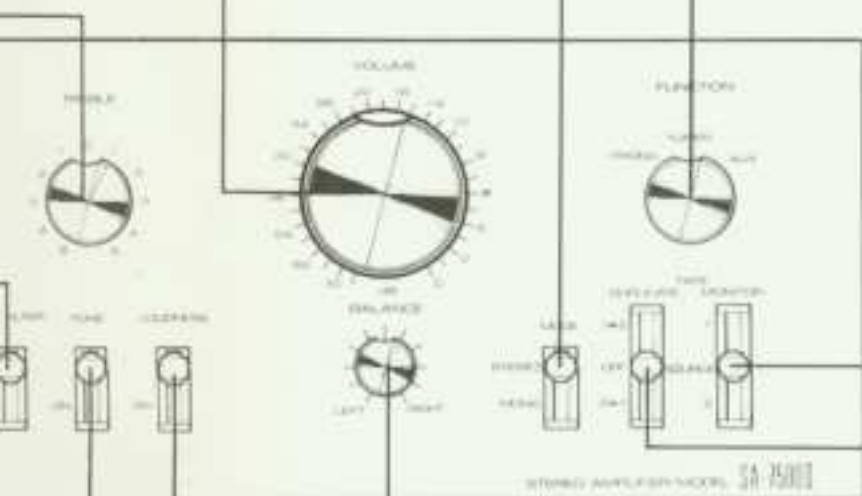
1: Playback or monitoring of a tape deck connected to the TAPE 1 jacks.

SOURCE: Be sure to set to this position when not using the tape deck for playback.

2: Playback or monitoring of a tape deck connected to the TAPE 2 jacks.

NOTE:

When listening to records or broadcasts, be sure to set this switch to SOURCE. Sound will not be obtained from speakers if set to 1 or 2.



BALANCE CONTROL

Adjusts relative left and right channel volume balance between speaker systems and headphones. If the right channel volume is insufficient, turn the control clockwise from center. Conversely, if the left channel volume is insufficient, turn the control counter-clockwise from center.

TAPE DUPLICATE SWITCH

Employ when using two tape decks for duplication or editing. Be sure to set to OFF position at other times.

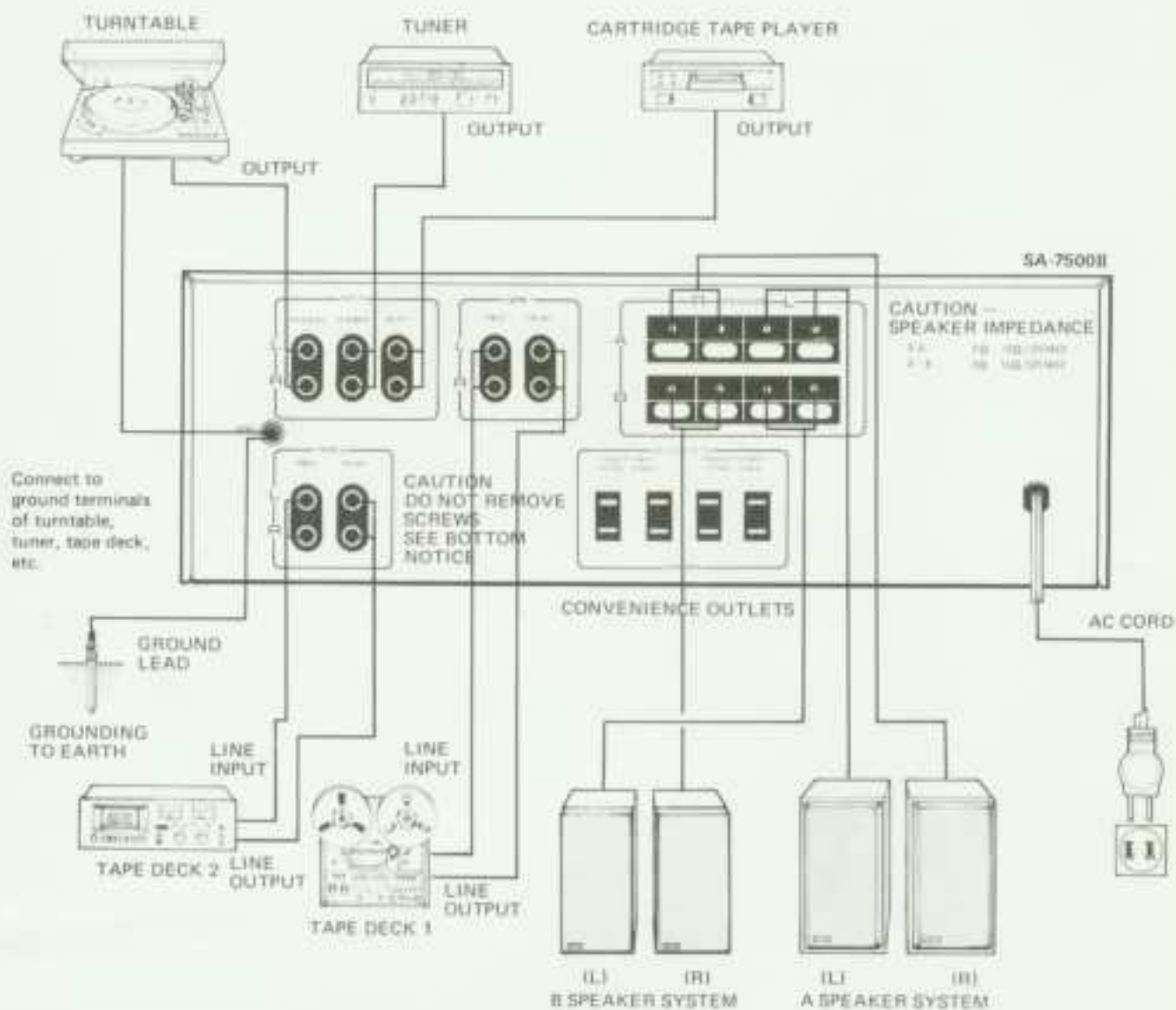
1 → 2: Duplication of tape from TAPE 1 (playback mode) to TAPE 2 (recording mode).

OFF: Set to this position when not using the duplication feature (this includes simultaneous recording with two tape decks and tape playback).

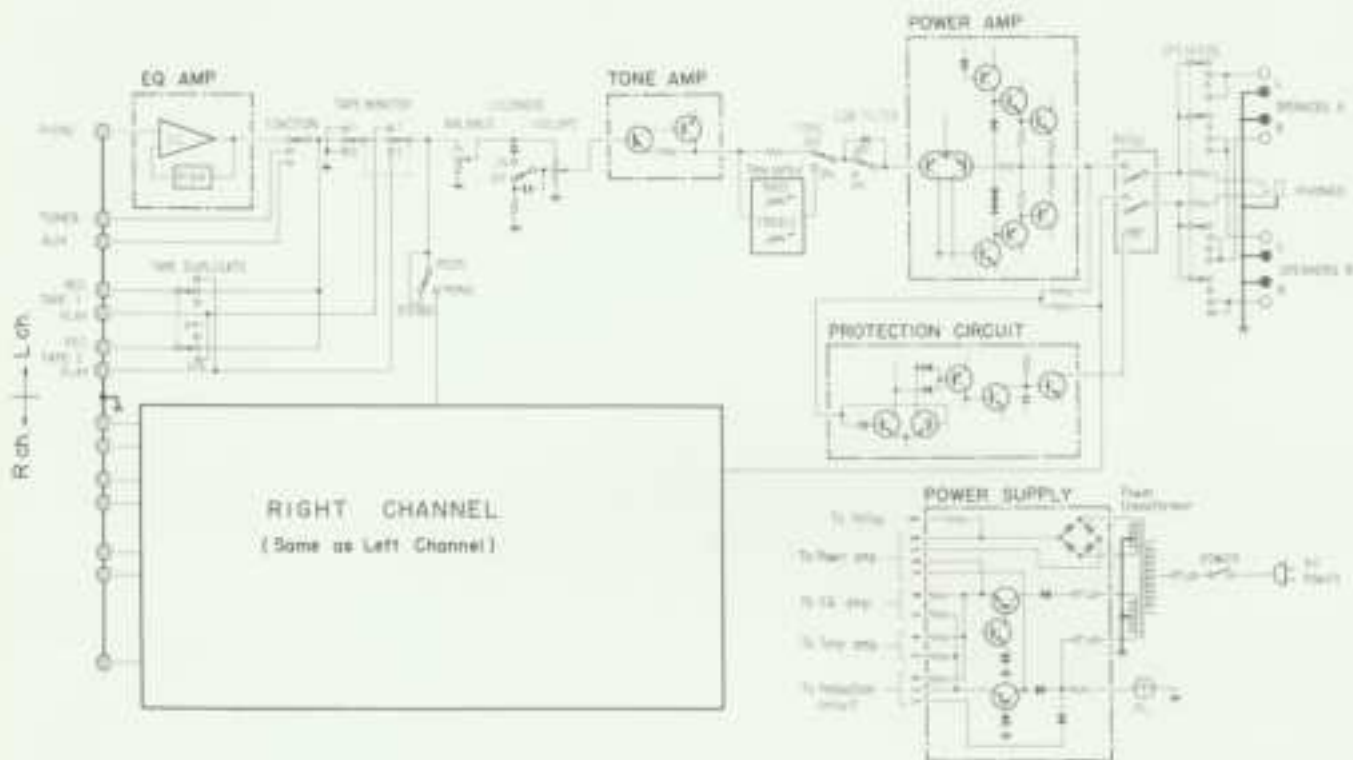
2 → 1: Duplication of tape from TAPE 2 (playback mode) to TAPE 1 (recording mode).

switch to ON to
response of the
loudness. This
tunes.

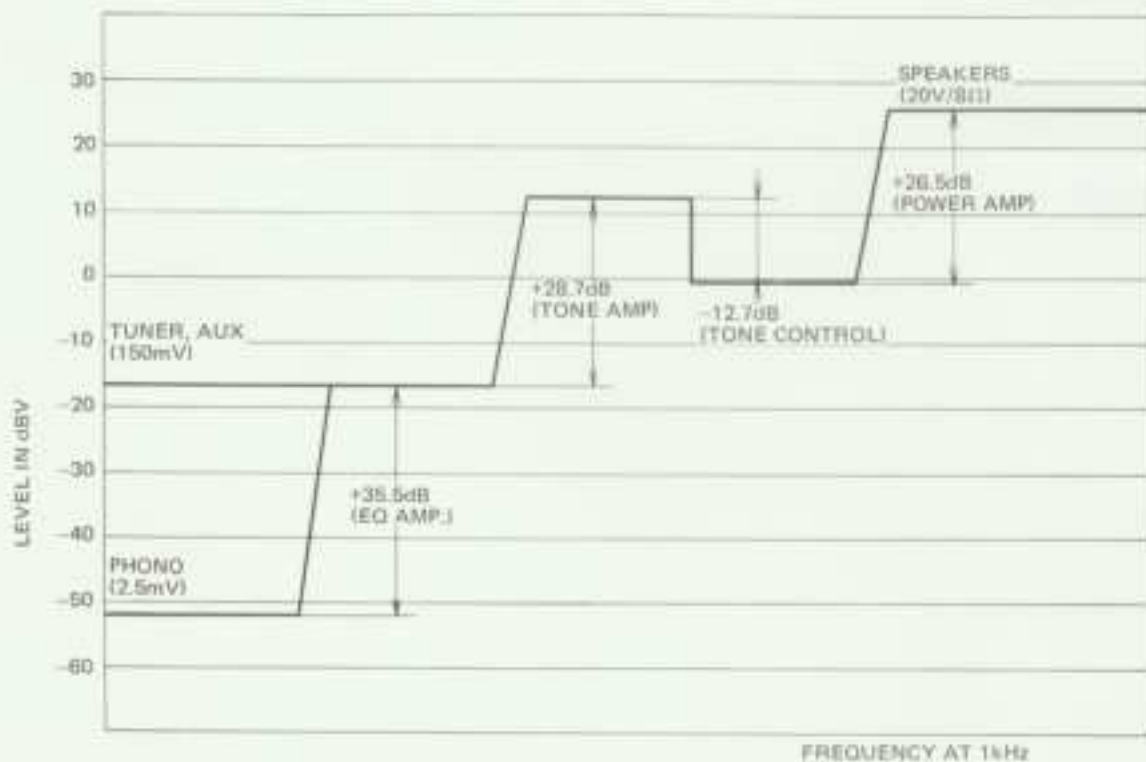
3. CONNECTION DIAGRAM



4. BLOCK DIAGRAM



5. LEVEL DIAGRAM



6. CIRCUIT DESCRIPTIONS

6.1 AF SECTION

Phono Equalizer Amplifier

This circuit is an NFB type equalizer, with one IC (M5211L-P) in both L and R channels. This IC is a low noise type, and gives an open loop gain of 86dB. It requires a dual positive and negative supply two power lines (+21V, -20V). In this application, 50.5dB of negative feedback is applied at 1kHz. The main performance specifications for this circuit include a voltage gain of 35.5dB (at 1kHz) a phono dynamic margin or overload level of 200mV (RMS, at 1kHz, with 0.1% total harmonic distortion), and RIAA equalization within ± 0.3 dB (20Hz-20,000Hz).

Tone Control Circuit

A CR-type tone control circuit is used in this unit. The signal is amplified to the necessary level by a two-stage direct-coupled amplifier with a voltage gain of about 28.7dB in front of the control circuit.

Figure 1 shows the basic circuit for the CR-type tone controls. This circuit consists of a combination of CR passive filters. VR1 is the treble control, and VR2 is the bass control, and both of them are continuously variable potentiometers.

The Mid-Range

The reactances of C_3 and C_4 are sufficiently small with respect to the resistance of VR_2 to ensure that VR_2 is shorted. The reactances of C_1 and C_2 , on the other hand, are large enough to ensure that the VR_1 circuit is open circuited. Therefore, the circuit in Figure 1, for mid-range frequencies, resolves into the attenuator network shown in Figure 2 which consists of R_1 and R_2 (in this unit, approximately -12.7dB).

High Frequency Region

The reactances of C_3 and C_4 are sufficiently small compared with the resistance of VR_2 , for VR_2 to be effectively shorted. The reactances of C_1 and C_2 become small, and the circuit in Figure 1 becomes equivalent to the circuit in Figure 3. Therefore, VR_1 (treble) is able to provide control of the high frequencies by changing the attenuation.

Low Frequency Region

The reactances of C_1 and C_2 are large, and the VR_1 circuit becomes open circuited. The reactances of C_3 and C_4 become large, and the circuit of Figure 1 becomes equivalent to the circuit in Figure 4. Therefore, VR_2 (bass) is able to provide control of

the low frequency regions by varying the attenuation.

Further, note that the range of treble and bass boost and cut is as follows: bass; +9dB, to -8dB (at 100Hz), treble; +8dB, to -6dB (at 10kHz).

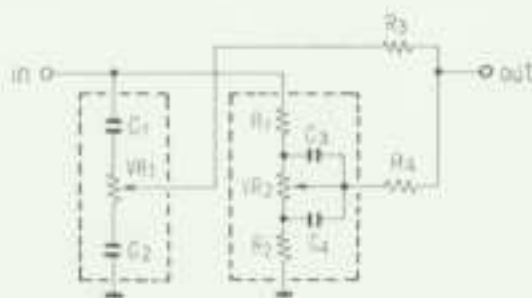


Fig. 1 Basic circuitry of CR-type tone control circuit

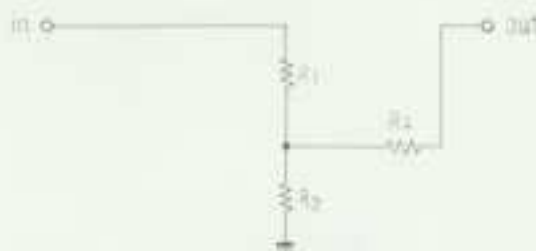


Fig. 2 Midrange operation of CR-type tone control circuit

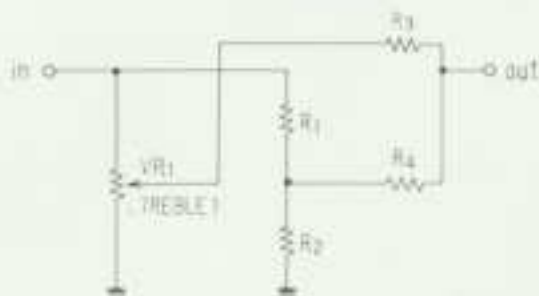


Fig. 3 High frequency operation of CR-type tone control circuit

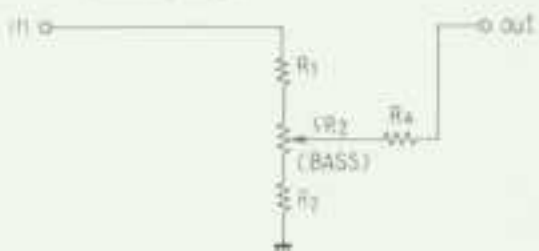


Fig. 4 Low frequency operation of CR-type tone control circuit

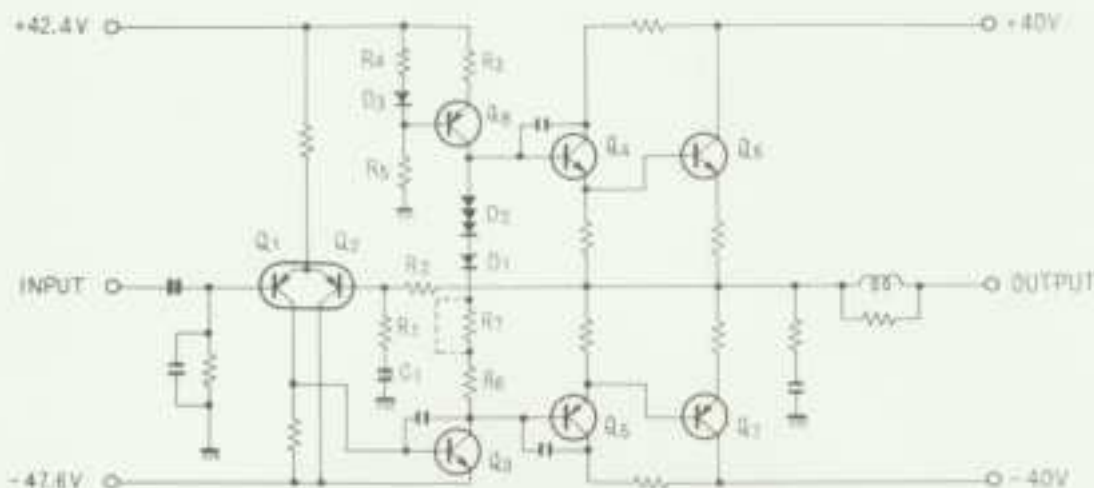


Fig. 5 Schematic diagram of power amplifier

Power Amplifier

The power amplifier of this set is, as shown in Fig. 5, a typical OCL amplifier.

The input stage, Q_1 and Q_2 , consists of a dual transistor package of two PNP transistors with closely matched characteristics, forming a differential amplifier. As the input signal is amplified, this circuit also serves to maintain the output midpoint DC potential at zero volts. Since C_1 represents an open circuit to DC, the output midpoint DC potential is applied to the base of Q_1 through R_2 . Since Q_1 and Q_2 form a differential amplifier, changes in the base potential of Q_2 are equivalent to the effect of an opposite change in the base potential of Q_1 , so that the output midpoint potential is changed in the opposite sense. It follows, therefore, that this arrangement serves to cancel out any movement in the output midpoint potential level.

The pre-driver (Q_3) requires a high voltage gain (since the power stage has no voltage gain). For this reason the constant current circuit formed by Q_3 , R_3 , R_4 and D_3 is used as the load circuit, so that the AC load impedance is increased, and the necessary high voltage gain achieved.

The power stage (Q_4 - Q_7) is a symmetrical complementary Darlington-connected circuit, in which R_5 (R_7), D_1 and D_2 supply the power stage bias.

6.2 PROTECTION CIRCUIT

This circuit protects the speakers in case of power amplifier malfunction, and also performs a muting function when the power supply is turned ON or OFF. The protection circuit is composed of two sections (Fig. 6).

1. Relay Driver Circuit

The relay which connects the output circuits is driven by this circuit. It also performs a muting function to prevent unpleasant noise during ON-OFF operation of the power supply as well as opening the output circuit on command from the detector circuits.

Muting Operation

When the power supply is turned ON, Q_4 base is reverse biased through D_3 , R_4 and R_3 , turning Q_4 OFF. Q_4 base potential rises as C_1 charges through R_7 & R_5 , and Q_4 turns ON several seconds later. The collector current of Q_4 then flows through the relay coil, operating the relay to turn on the power amplifier output circuit. The reverse bias of Q_4 base from D_3 , R_4 and R_3 disappears when the power supply is set from ON to OFF.

Q_4 remains ON however, due to the residual power supply voltage. C_1 very rapidly discharges, Q_4 base potential drops and Q_4 turns OFF. The relay releases and the power amplifier output circuit turns OFF.

Note:

Q_4 is normally OFF due to base bias and does not participate in the muting operation.

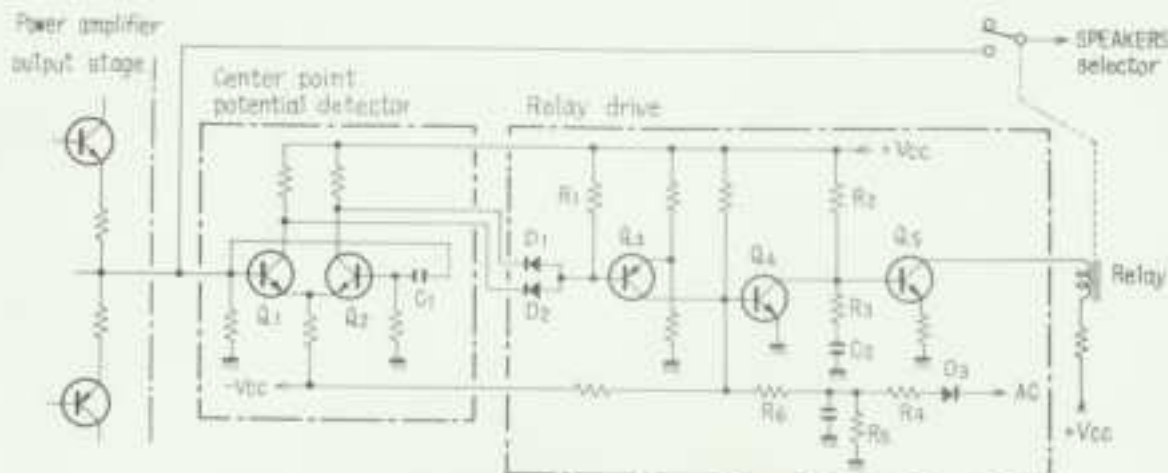


Fig. 6 Basic circuitry of protection circuit

Operation by Detector Circuit Command

Command from the detector circuits pass through one of D_1 or D_2 and are applied in the form of a current flow. Q_1 is normally reverse biased through R_1 , but when a large current flows through one of these diodes, Q_1 base potential declines according to the voltage drop at R_1 . Q_2 then becomes ON, Q_4 base potential rises and Q_4 becomes ON. C_1 rapidly discharges and Q_1 base potential drops, turning Q_1 OFF. The relay releases and the power amplifier output circuit becomes cut off.

2. Center Point Potential Detector Circuit

If a DC potential is produced at the junction point of the power amplifier, a command is sent to the relay drive circuit.

Q_1 and Q_2 compose a differential amplifier. When the same input is applied to both input terminals (Q_1 and Q_2 bases), no output is present. However, if there is a difference between the terminal inputs, the difference is amplified and becomes the output between the two collectors. During normal operation, an AC signal only is present at the junction point. As C_1 reactance is sufficiently low, the same signal is applied to Q_1 and Q_2 bases, resulting in an absence of output at the collector sides.

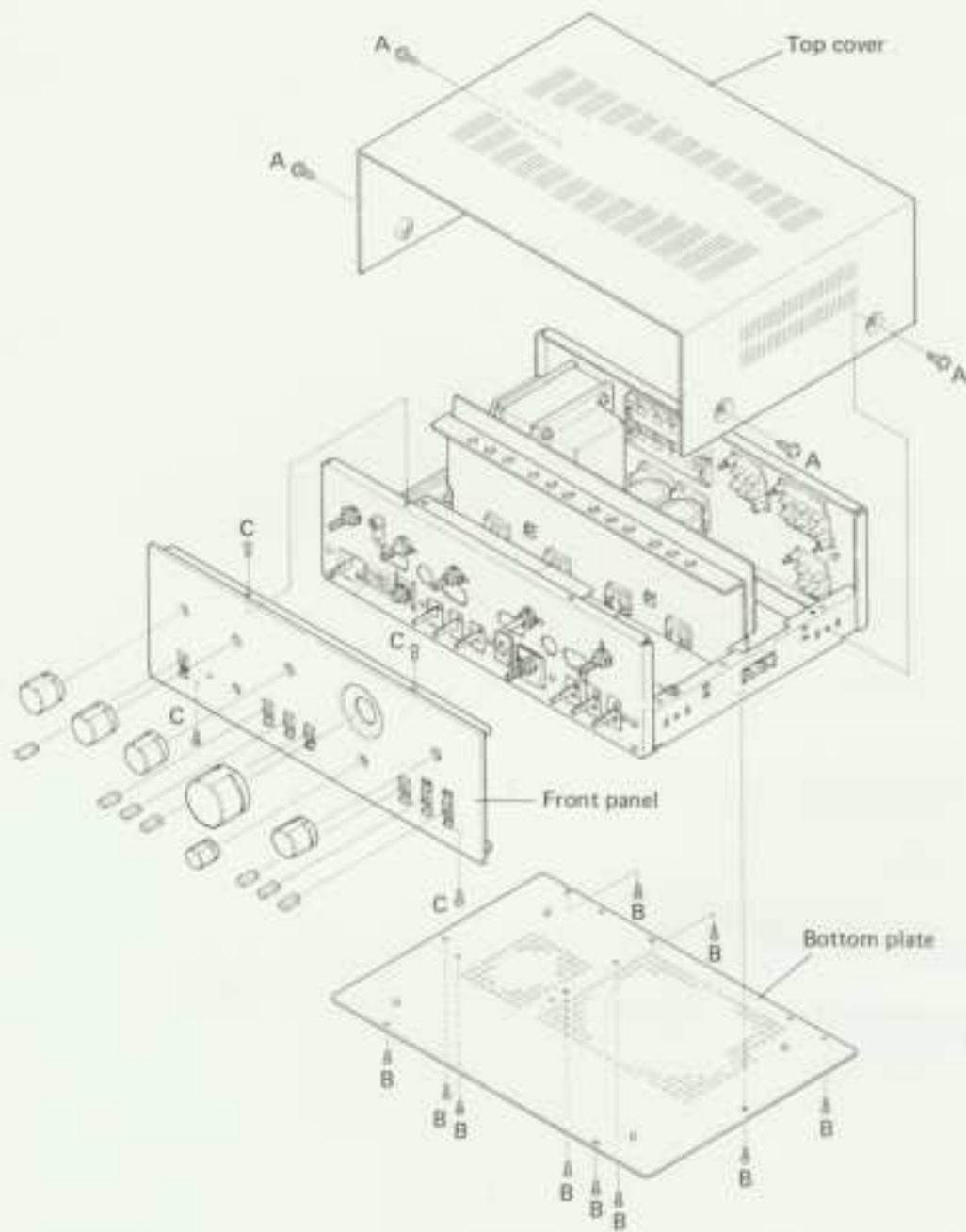
When a DC potential is produced at the junction point, it becomes the input of Q_1 only. If the voltage is negative, Q_1 collector current declines and at Q_2 the collector current increases and the potential drops, causing current to flow through D_1 .

If the DC voltage is positive, Q_1 collector current increases and the potential drops, while at Q_2 the collector current decreases and the potential rises. Current therefore flows through D_2 .

6.3 POWER SUPPLY CIRCUIT

The final stage of the power amplifier consists of a $\pm 40V$ balanced power supply using bridge rectification and two 10,000 μF electrolytic capacitors. Separate transformer windings are used to supply the other stages, together with half-wave rectification and regulatory circuits using transistors and Zener diodes to deliver the necessary electrical power.

7. DISASSEMBLY



Top Cover

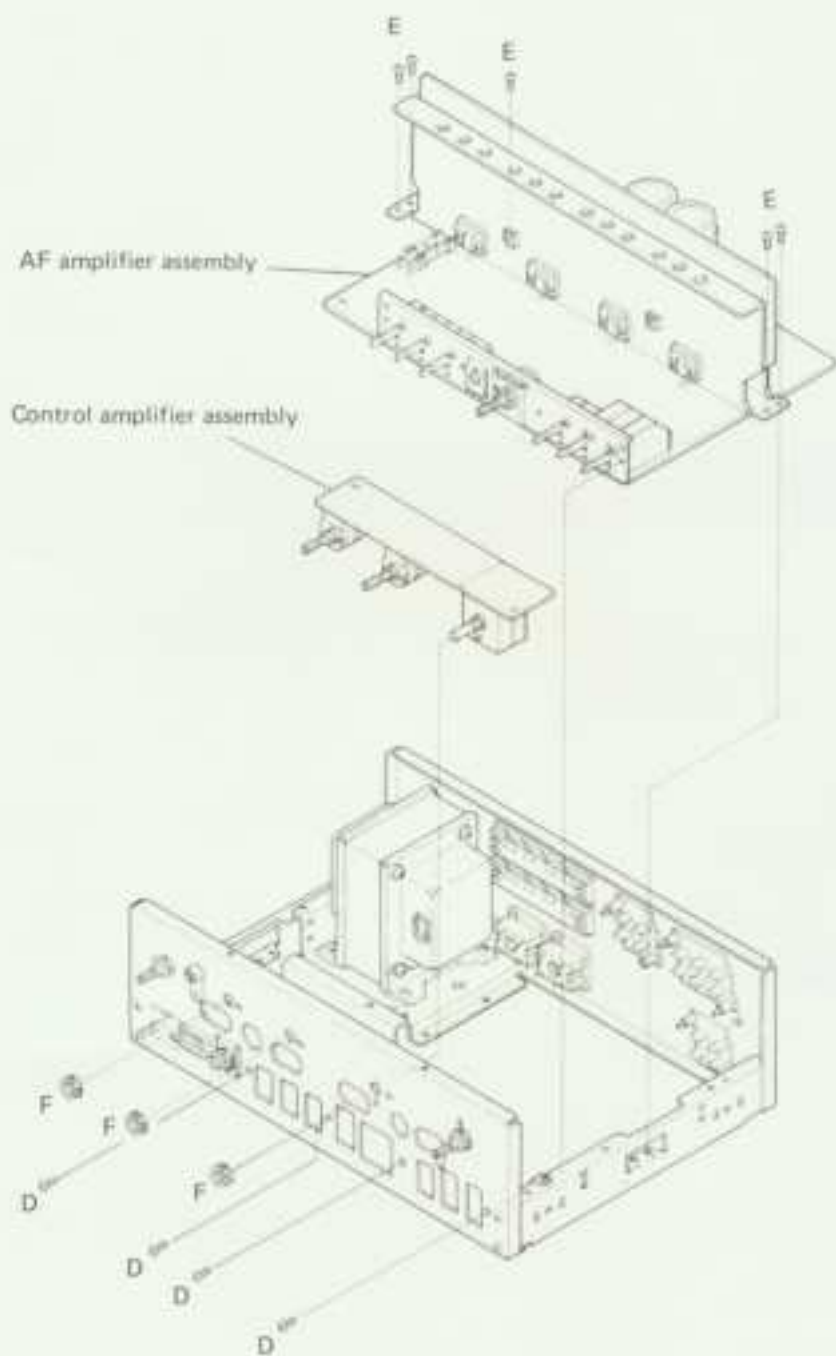
Remove screws A (two each, on left and right-hand sides).

Bottom Plate

Remove screws B (ten in all).

Front Panel

Pull off all the knobs (loose the set screws of VOLUME knob), and remove the upper and lower retaining screws C (a total of four screws).

**AF Amplifier Assembly**

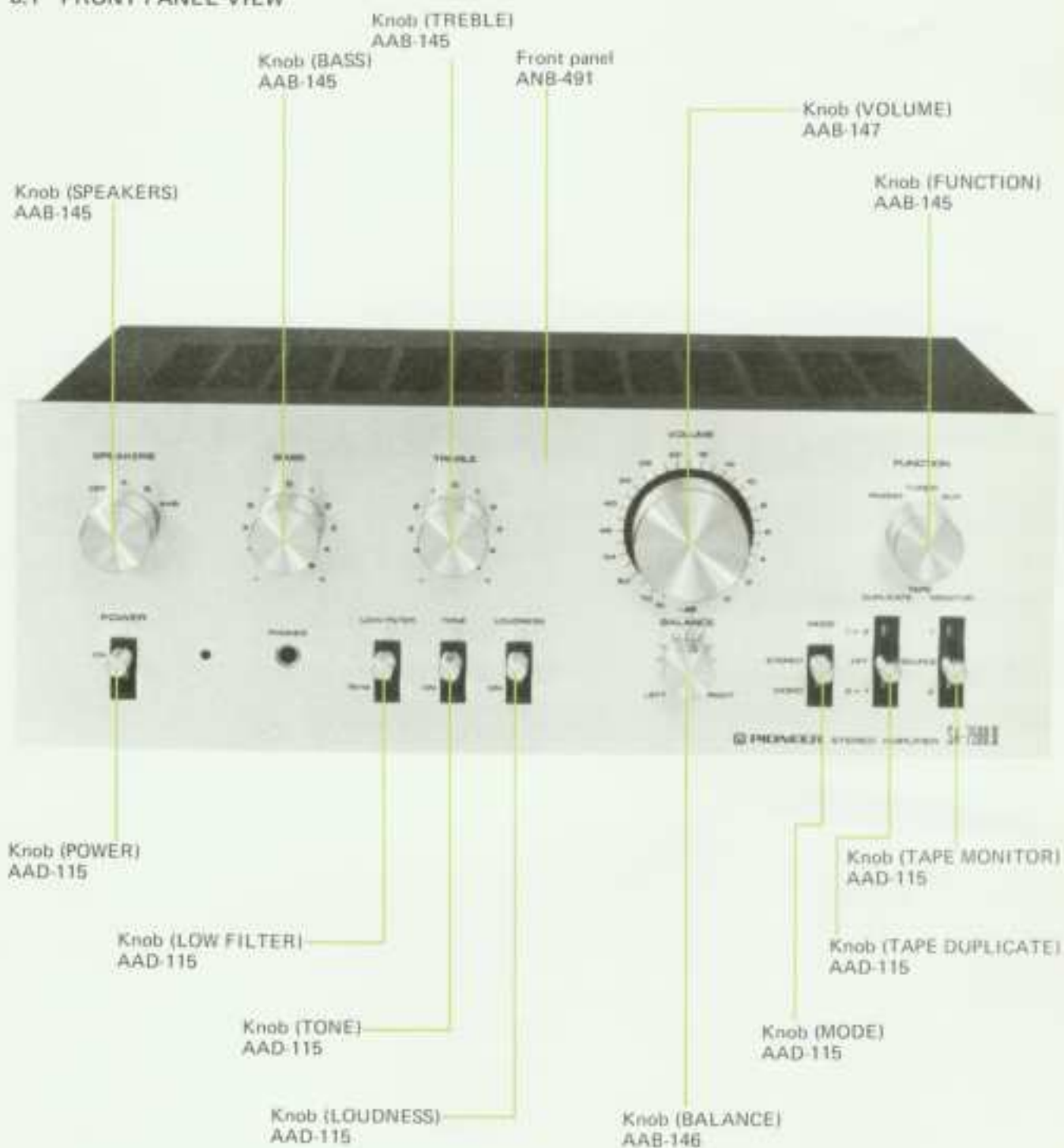
Remove the front side retaining screws D (four in all) and top side retaining screws E (five in all).

Control Amplifier Assembly

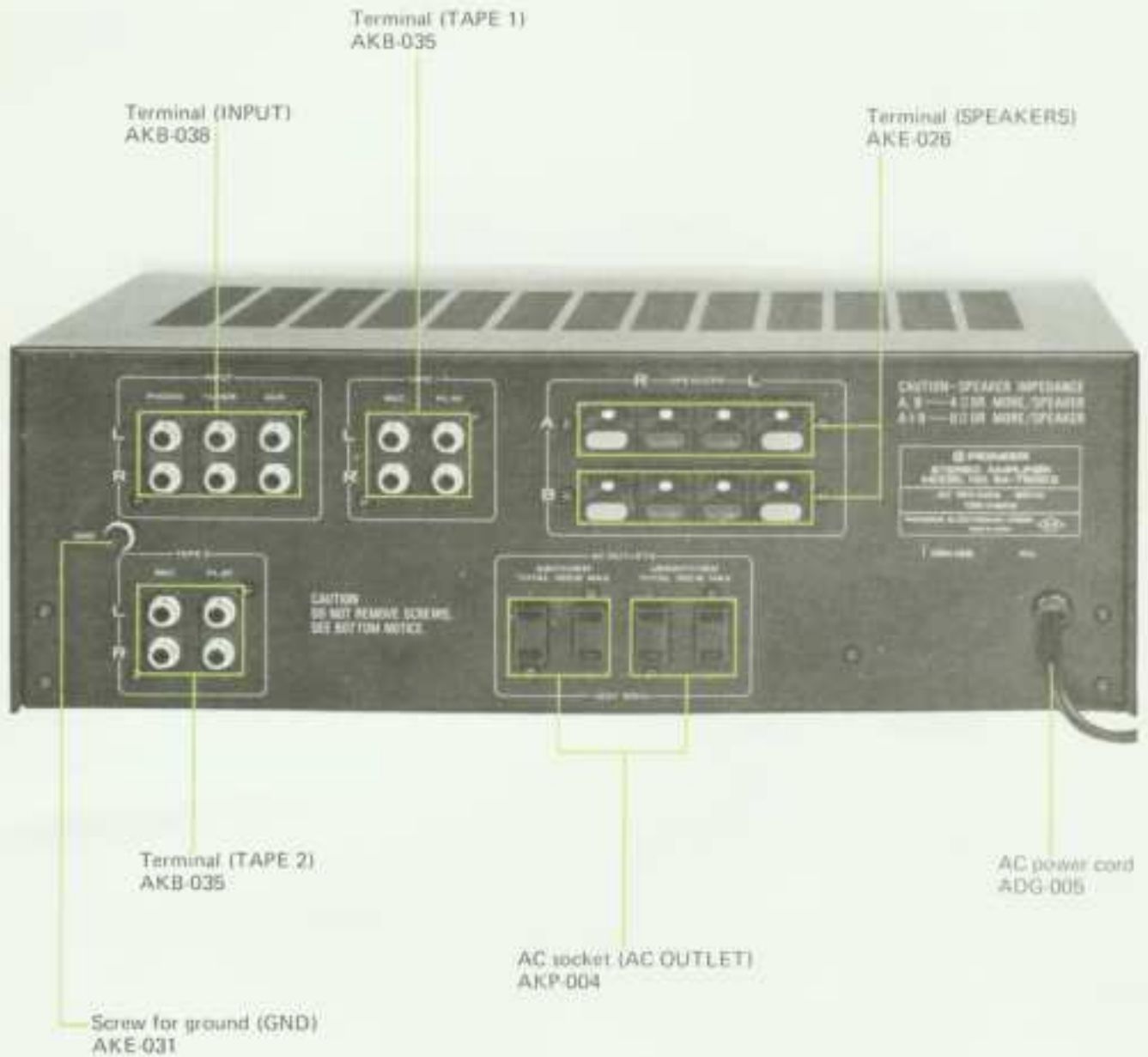
Remove nuts F (three in all).

8. PARTS LOCATION

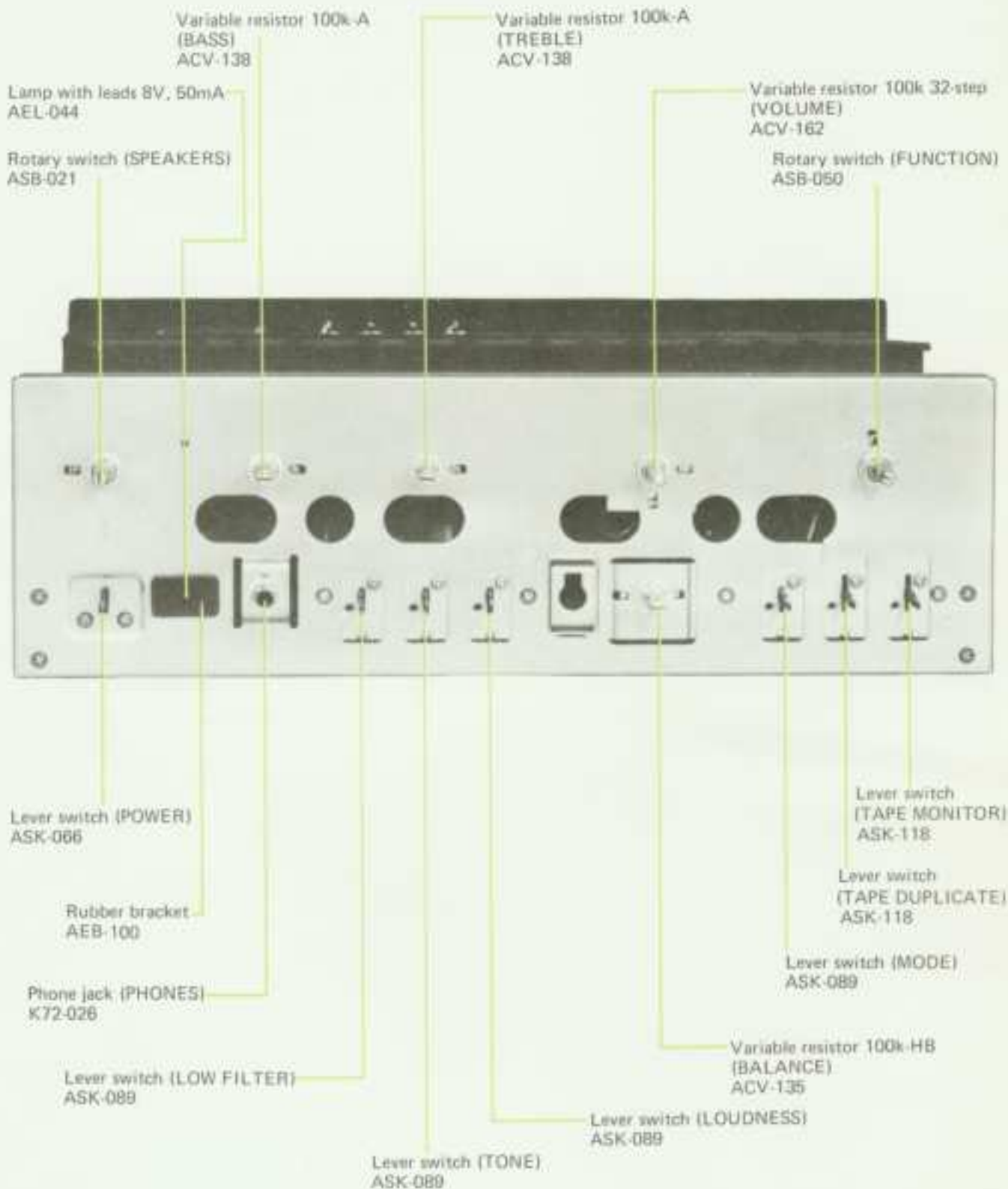
8.1 FRONT PANEL VIEW



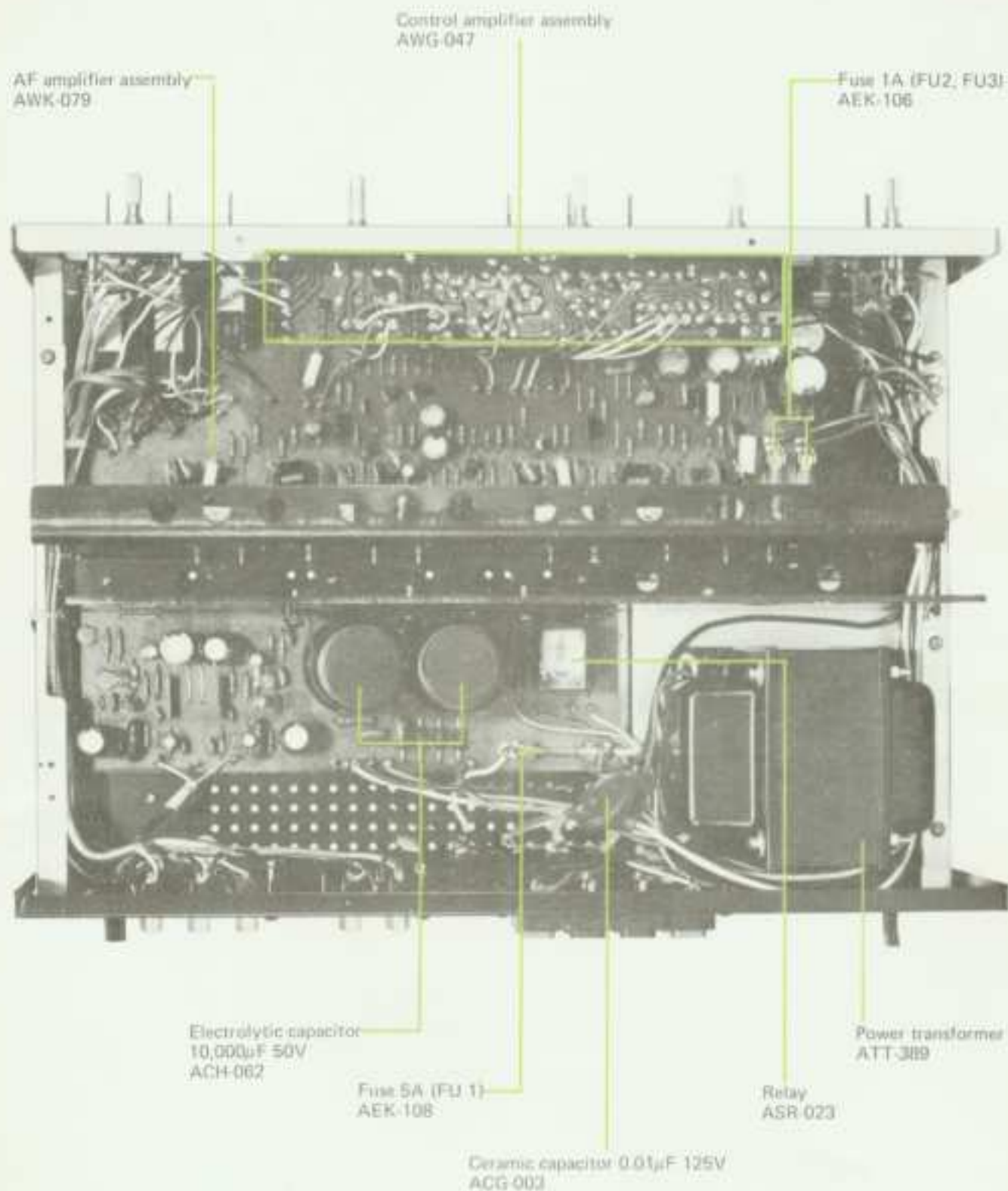
8.2 REAR PANEL VIEW



8.3 FRONT VIEW WITH PANEL REMOVED

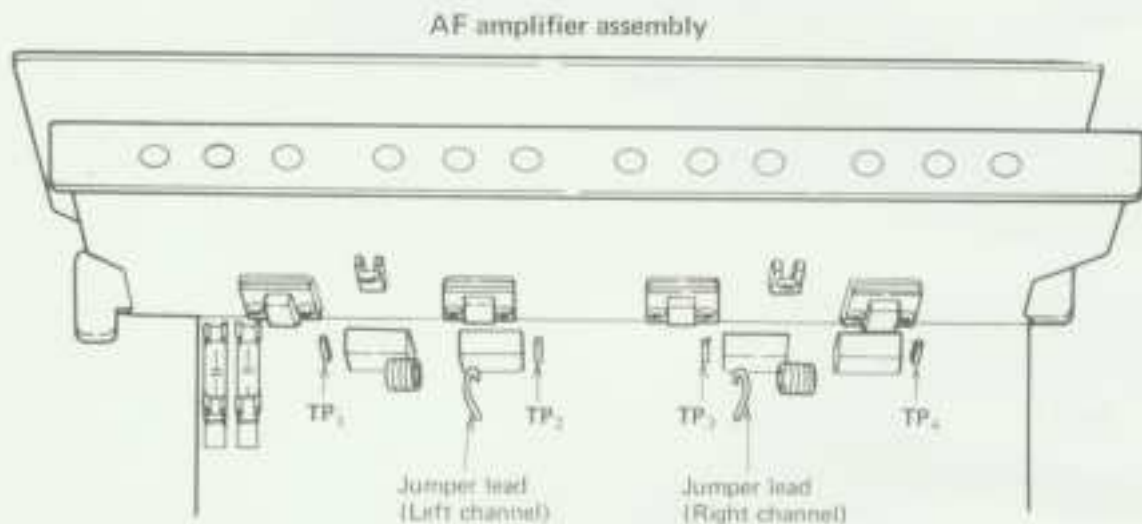


8.4 TOP VIEW



9. ADJUSTMENT

1. 8 ohms dummy loads should be connected across the SPEAKERS A terminals.
2. Set the SPEAKERS switch to A position.
3. Set the TONE switch to OFF position.
4. Set the VOLUME control to minimum.
5. A DC voltmeter should be connect across between TP terminals 1(+), 2(-) for Left channel and 4(+), 3(-) for Right channel.
6. DC voltmeter reading tolerance is from 10mV to 70mV. Cut the jumper lead, if the voltage less then 10mV. Check the circuit, if the voltage more than 70mV.
7. Finally, apply an actual signal, and check for no crossover distortion.



10. EXPLODED VIEW

A

Screw 4x8
ABA-079

Top cover
ANE 127

B

Screw 4x8
ABA-079

C

Knob (SPEAKERS)
AAB-145

Knob (POWER)
AAD-115

Knob (BASS, TREBLE)
AAB-145

Knob (TONE, LOUDNESS, LOW FILTER)
AAD-115

Knob (VOLUME)
AAB-147

Knob (BALANCE)
AAB-148

Knob (MODE, DUPLICATE, MONITOR)
AAD-115

Knob (FUNCTION)
AAB-145

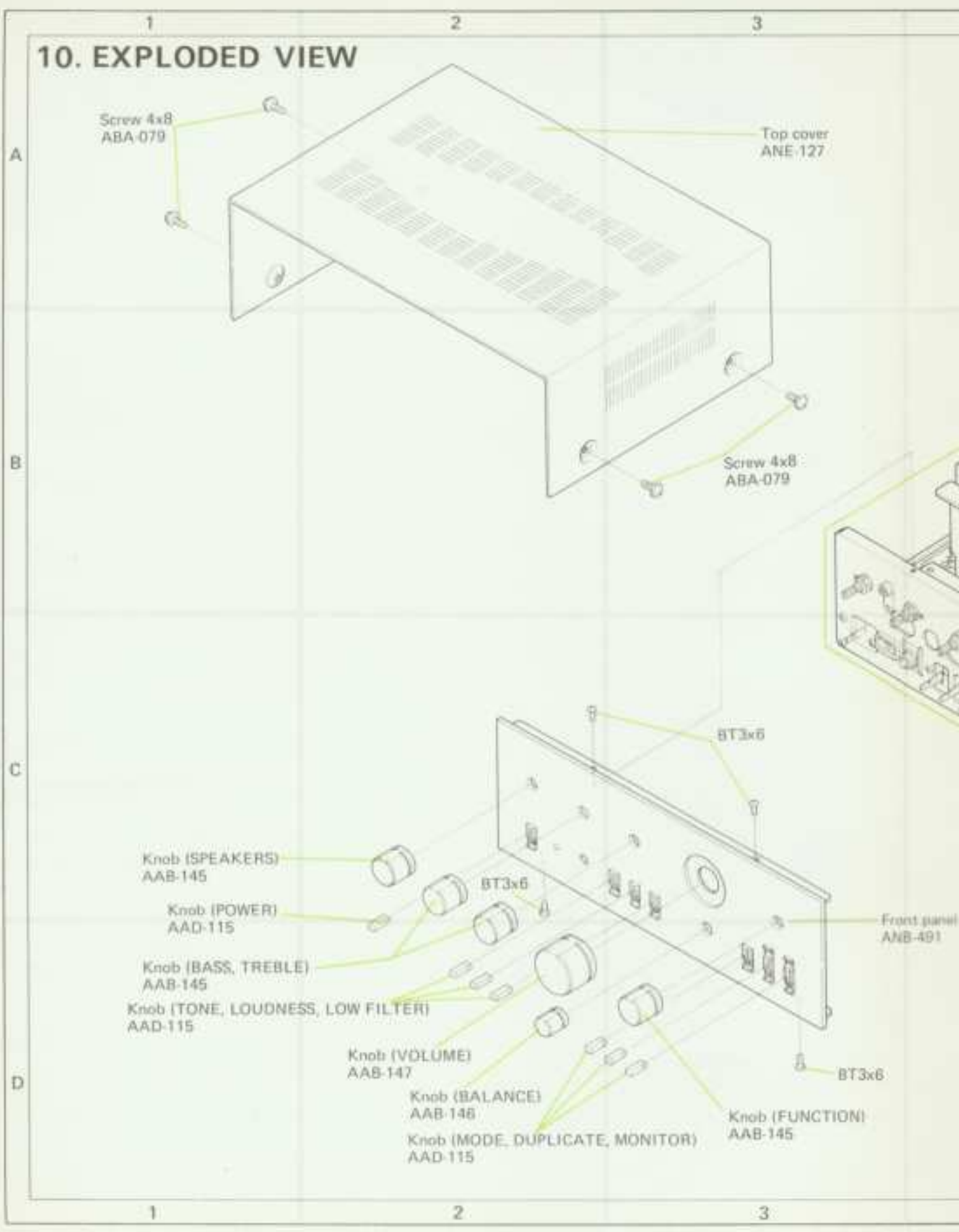
Front panel
ANB-491

D

1

2

3



4

5

6

NOTE:

Parts indicated in green type cannot be supplied.

Top cover
ANE-127

A

PART 2
See Page 21.PART 1
See Pages 19–20.Screw 3x8
ABA-002Screw 3x8
ABA-002

B

Screw 3x8
ABA-002

C

Screw 3x8
ABA-002

D

Front panel
ANB-491Screw 3x8
ABA-002Foot
AEC-083

RT4x10

Screw 3x8
ABA-002Foot
AEC-083

RT4x10

Foot
AEC-083Screw 3x8
ABA-002Foot
AEC-083

RT4x10

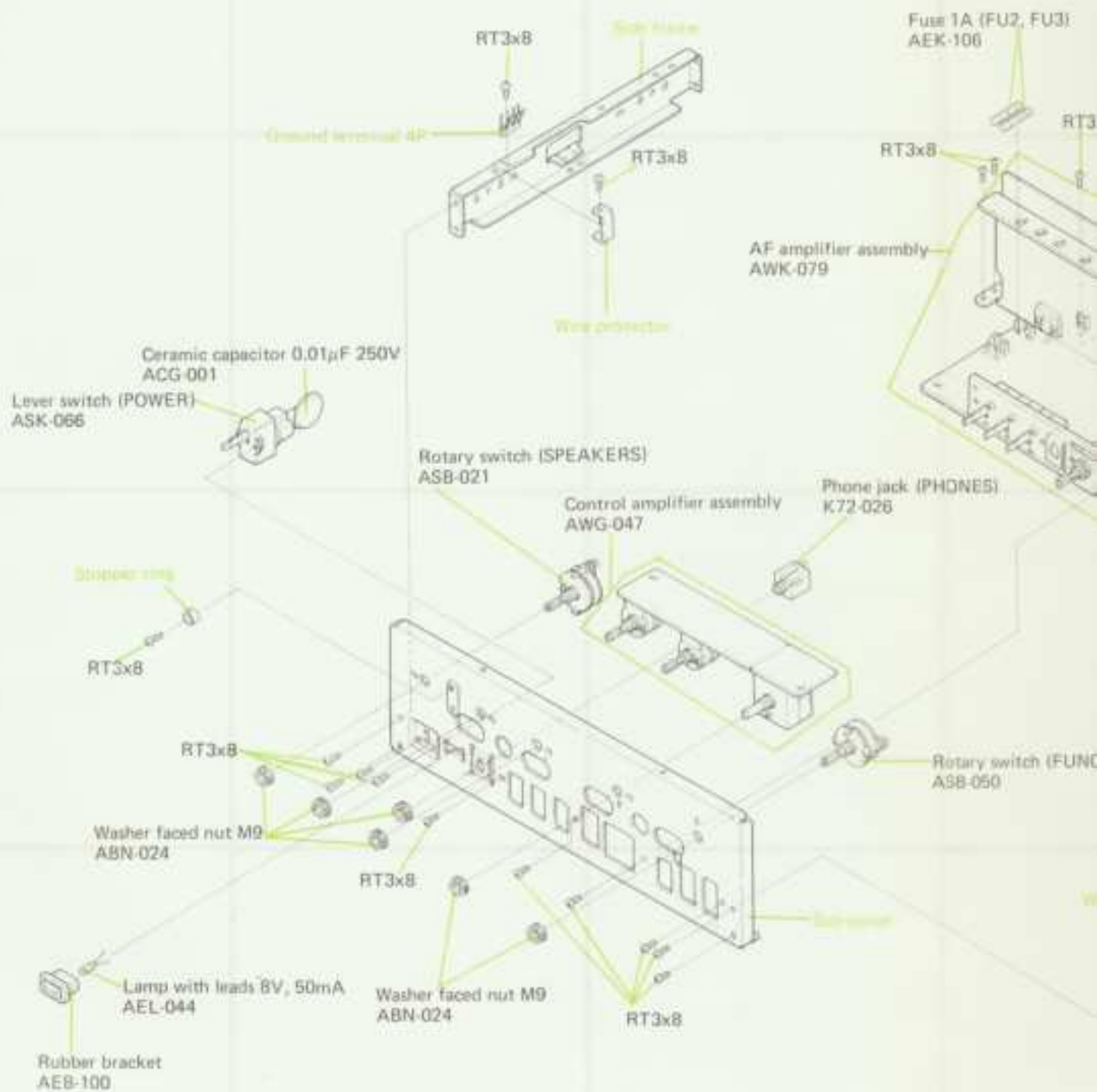
(FUNCTION)
45

4

5

6

Part 1



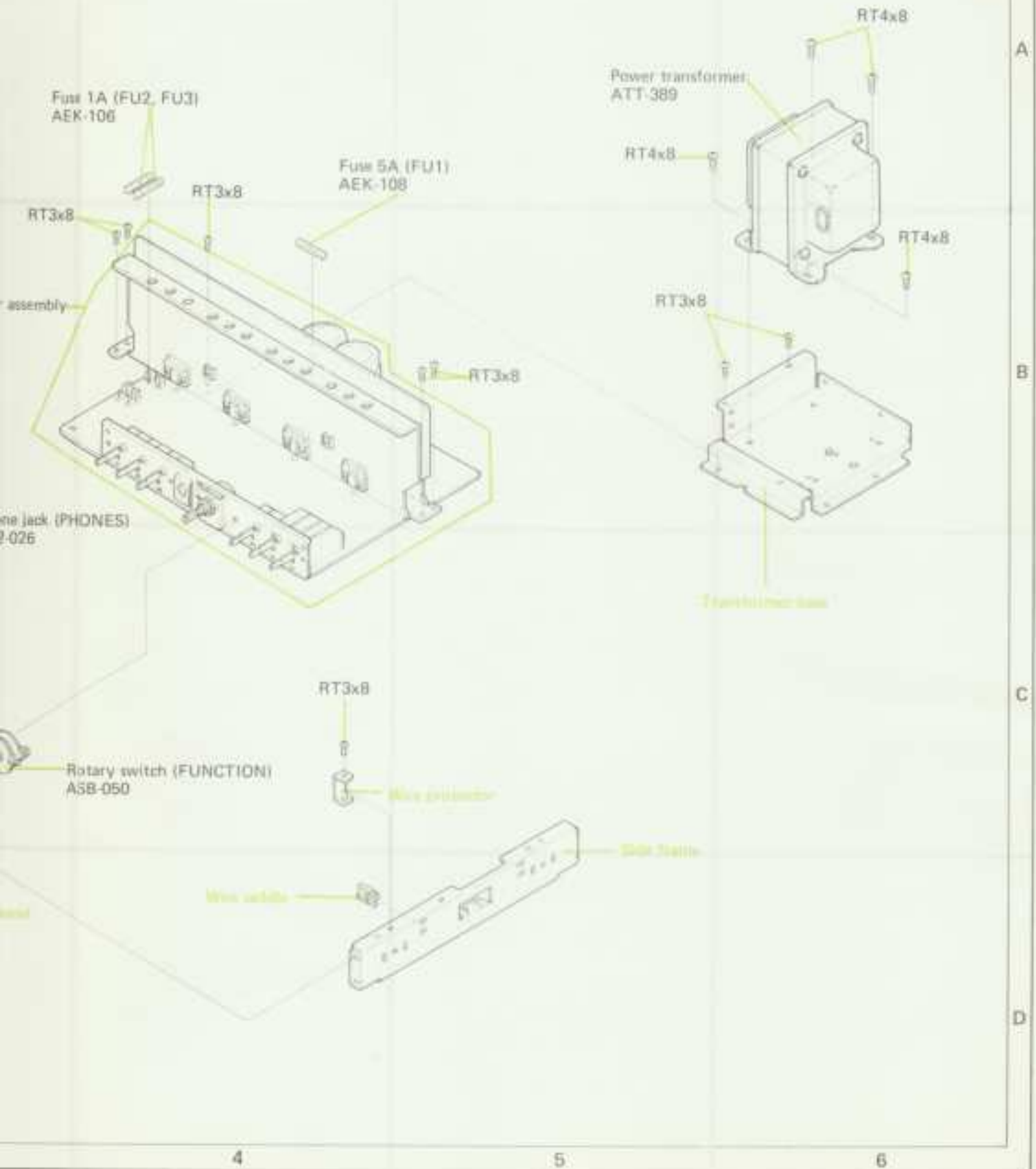
4

5

6

NOTE:

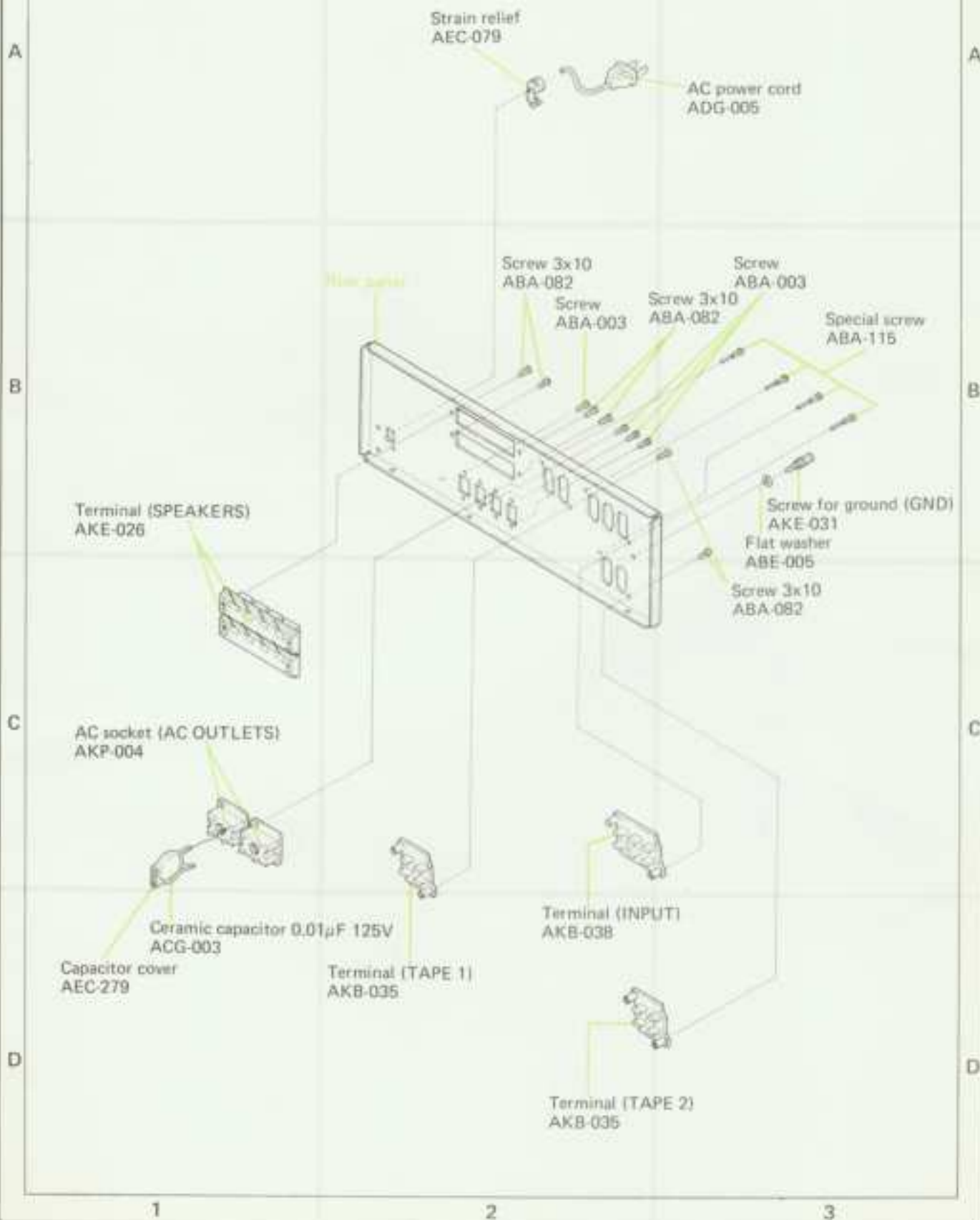
Parts indicated in green type cannot be supplied.



Part 2

NOTE:

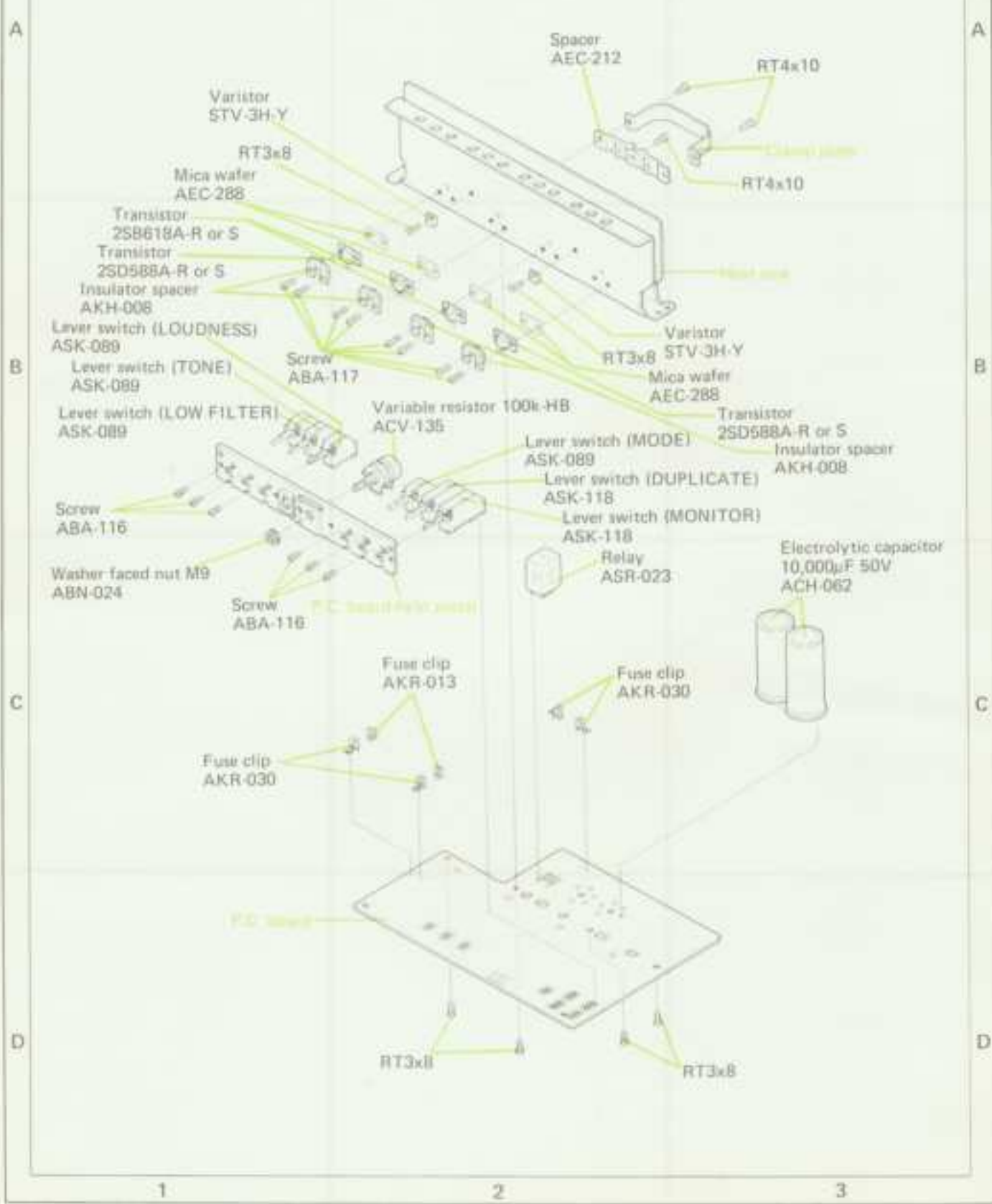
Parts indicated in green type cannot be supplied.



AF Amplifier Assembly (AWK-079)

NOTE:

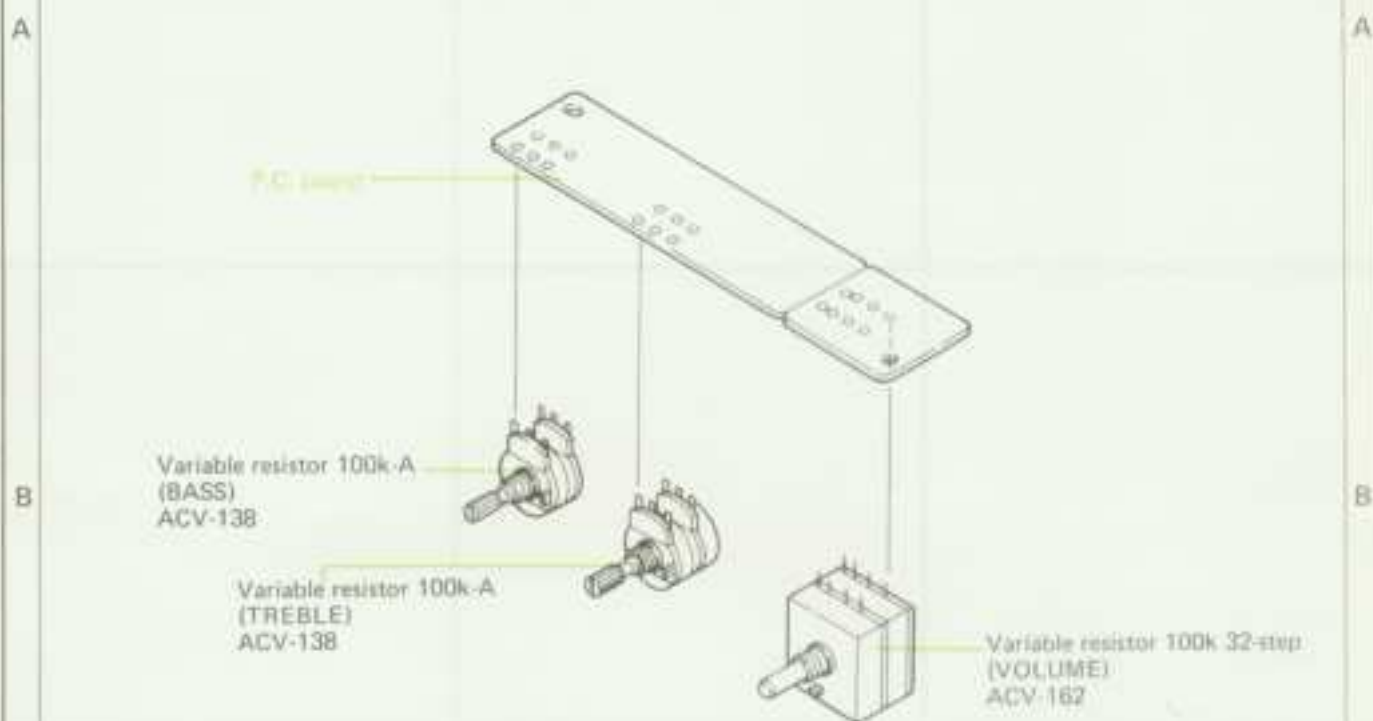
Parts indicated in green type cannot be supplied.



Control Amplifier Assembly (AWG-047)




NOTE:

Parts indicated in green type cannot be supplied.



NOMENCLATURE OF SCREWS

The following symbols stand for screws

Symbol	Description	Shape
RT	Brazier head tapping screw	
PT	Flat head tapping screw	
BT	Binding head tapping screw	

11. SCHEMATIC DIAGRAMS, P.C. BOARD PATTERNS, AND PARTS LIST

11.1 MISCELLANEA

NOTE:

- Capacitors: in μF unless otherwise noted $p.pF$
- Resistors: in Ω , $\%W$ unless otherwise noted $k:k\Omega$, $M:M\Omega$

Miscellaneous Parts List

SWITCHES

Symbol	Description	Part No.
S1	Rotary switch (FUNCTION)	ASB-050
S9	Rotary switch (SPEAKERS)	ASB-021
S10	Lever switch (POWER)	ASK-066

TRANSFORMER

Symbol	Description	Part No.
T1	Power transformer	ATT-389

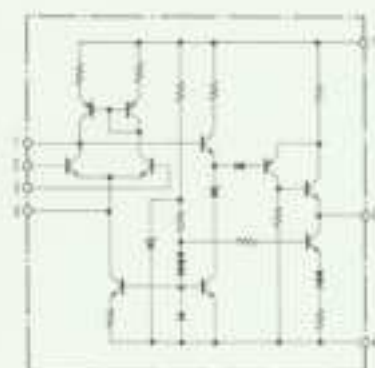
LAMP AND FUSES

Symbol	Description	Part No.
PL1	Lamp with leads 8V, 50mA	AEL-044
FU1	Fuse 5A	AEK-108
FU2	Fuse 1A	AEK-106
FU3	Fuse 1A	AEK-106

CAPACITORS

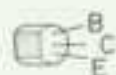
Symbol	Description	Part No.
C1	Ceramic 0.01 250V	ACG-001
C2	Ceramic 0.01 125V	ACG-003
C3	Ceramic 0.047 50V	CKDYF 4732 50
C4	Ceramic 0.047 50V	CKDYF 4732 50
C5	Ceramic 0.047 50V	CKDYF 4732 50
C6	Ceramic 0.047 50V	CKDYF 4732 50
C7	Ceramic 0.047 50V	CKDYF 4732 50

Circuit Diagram of IC (M5211L-P)

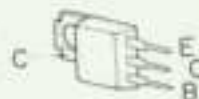


External Appearance of Transistors and IC

25A640
25A733
25A857
25C945A
25C1222
25C1438



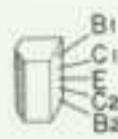
25B526
25B527
25D357



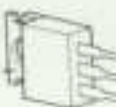
25B816A
25D686A



25A798



25D325



25C1166

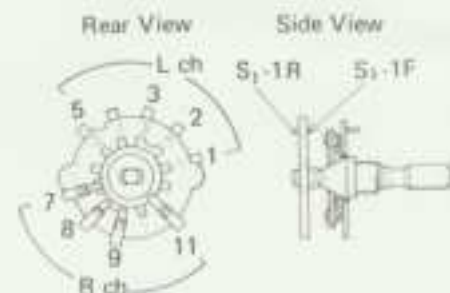


M5211L-P

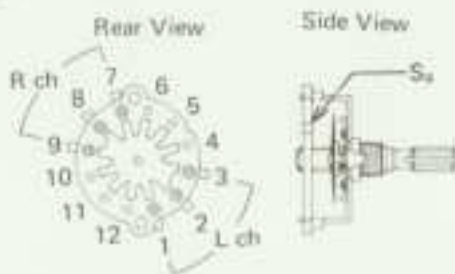


Diagram of Rotary Switches

S₁: FUNCTION switch

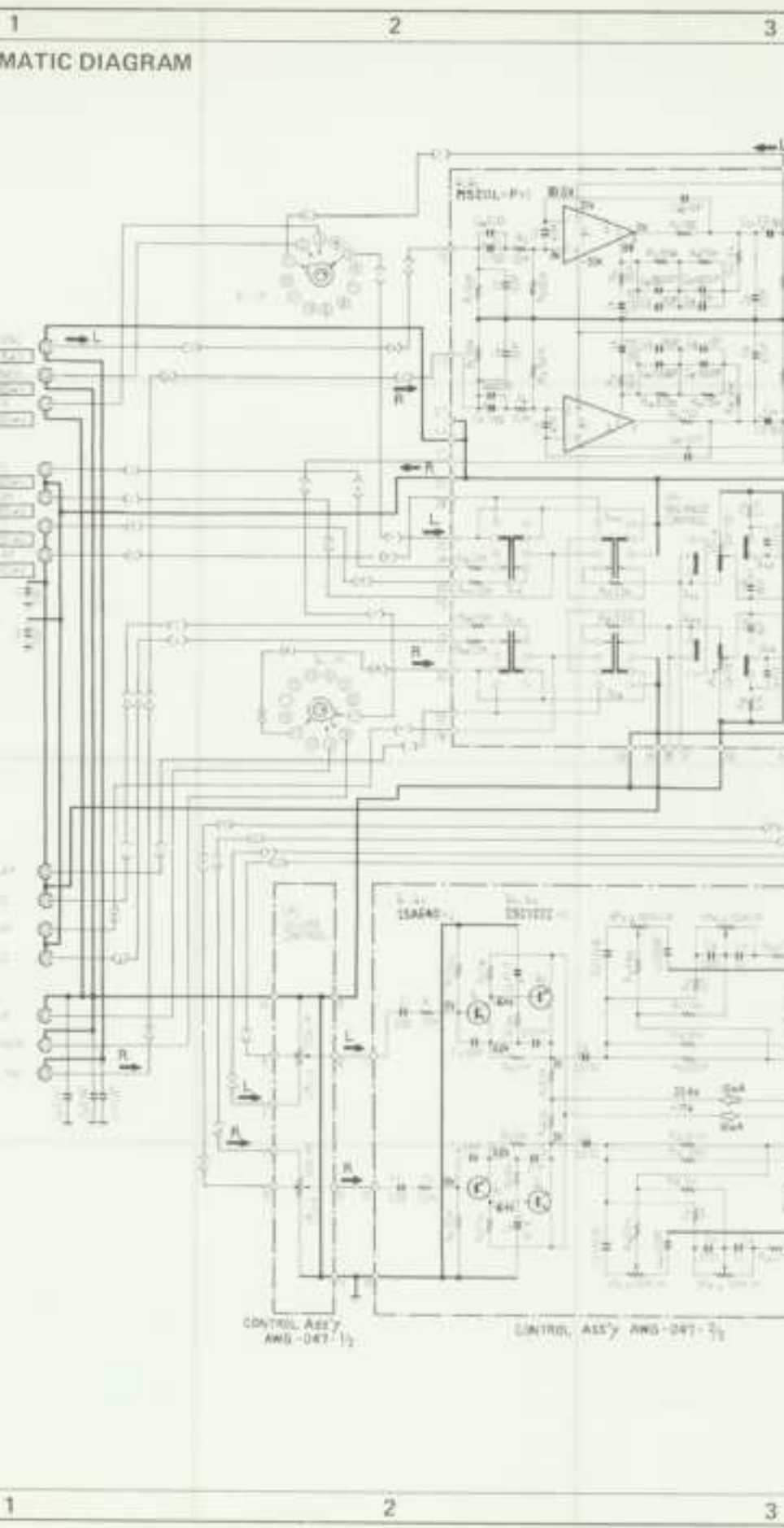


S₉: SPEAKERS switch



11.2 SCHEMATIC DIAGRAM

A
B
C
D



4

5

6

NOTE:

The indicated semiconductors are representative units only. Other alternative semiconductors may be used and are listed in the parts list.

SWITCHES:

1. FUNCTION
2. POWER
3. A/B

4. VAC RELAY
1 - 22 - 1 - 1

5. VAC RELAY
1 - 22 - 1 - 2

6. RELAY
1 - 22 - 1 - 1

7. RELAY
1 - 22 - 1 - 2

8. RELAY
1 - 22 - 1 - 3

9. RELAY
1 - 22 - 1 - 4

10. RELAY
1 - 22 - 1 - 5

11. RELAY
1 - 22 - 1 - 6

12. RELAY
1 - 22 - 1 - 7

13. RELAY
1 - 22 - 1 - 8

RESISTORS:

14. 100K 1/4W 1% TOL
15. 100K 1/4W 1% TOL

CAPACITORS:

16. 100K 1/4W 1% TOL
17. 100K 1/4W 1% TOL

NOTES:

1. 100K 1/4W 1% TOL

2. 100K 1/4W 1% TOL

3. 100K 1/4W 1% TOL

4. 100K 1/4W 1% TOL

5. 100K 1/4W 1% TOL

25A70B	25A70C	25A70D	25A70E	25A70F	25A70G	25A70H	25A70I	25A70J	25A70K	25A70L	25A70M	25A70N	25A70O	25A70P	25A70Q	25A70R	25A70S	25A70T	25A70U	25A70V	25A70W	25A70X	25A70Y	25A70Z
25A70B	25A70C	25A70D	25A70E	25A70F	25A70G	25A70H	25A70I	25A70J	25A70K	25A70L	25A70M	25A70N	25A70O	25A70P	25A70Q	25A70R	25A70S	25A70T	25A70U	25A70V	25A70W	25A70X	25A70Y	25A70Z

AF ASSY ANK-010

4

5

6

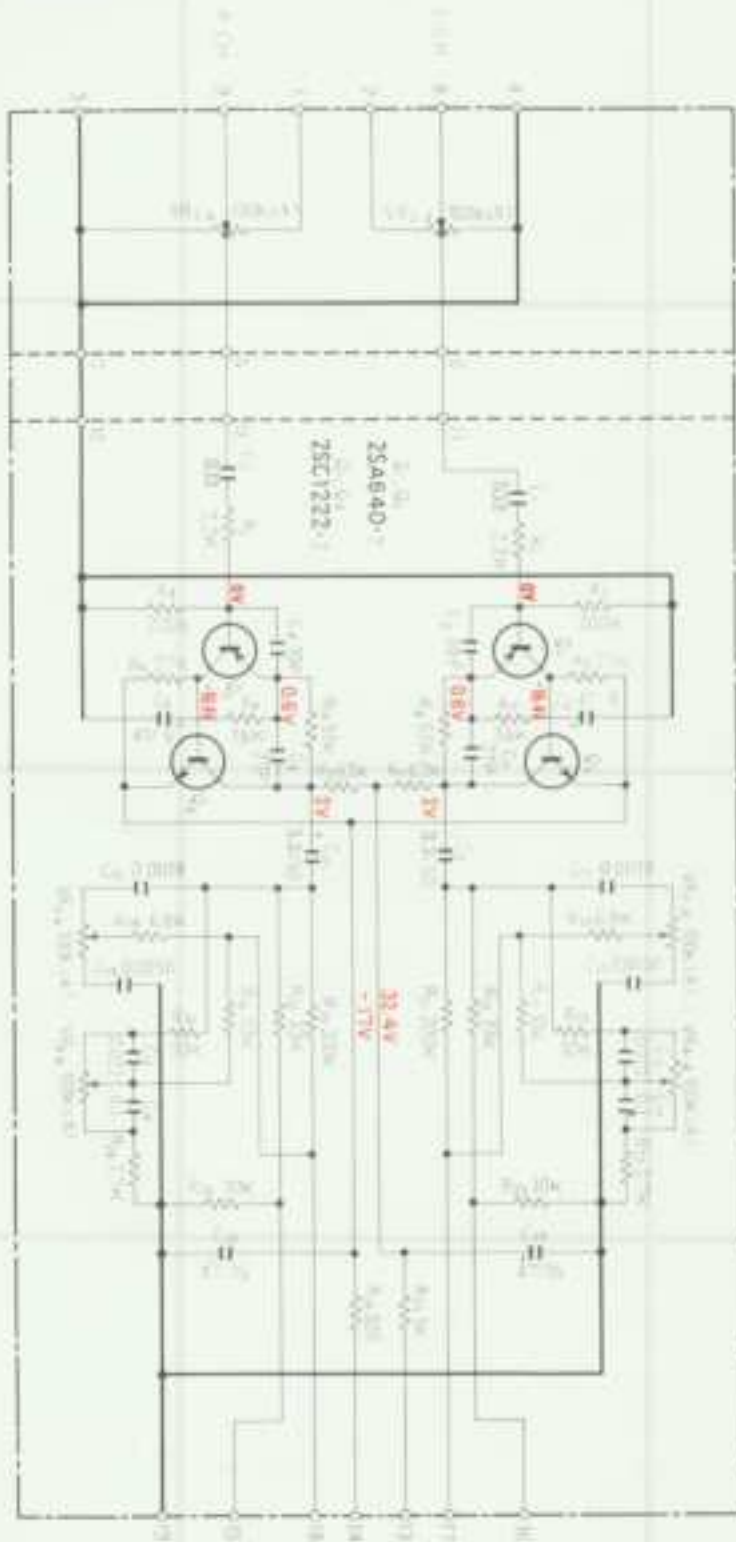
A

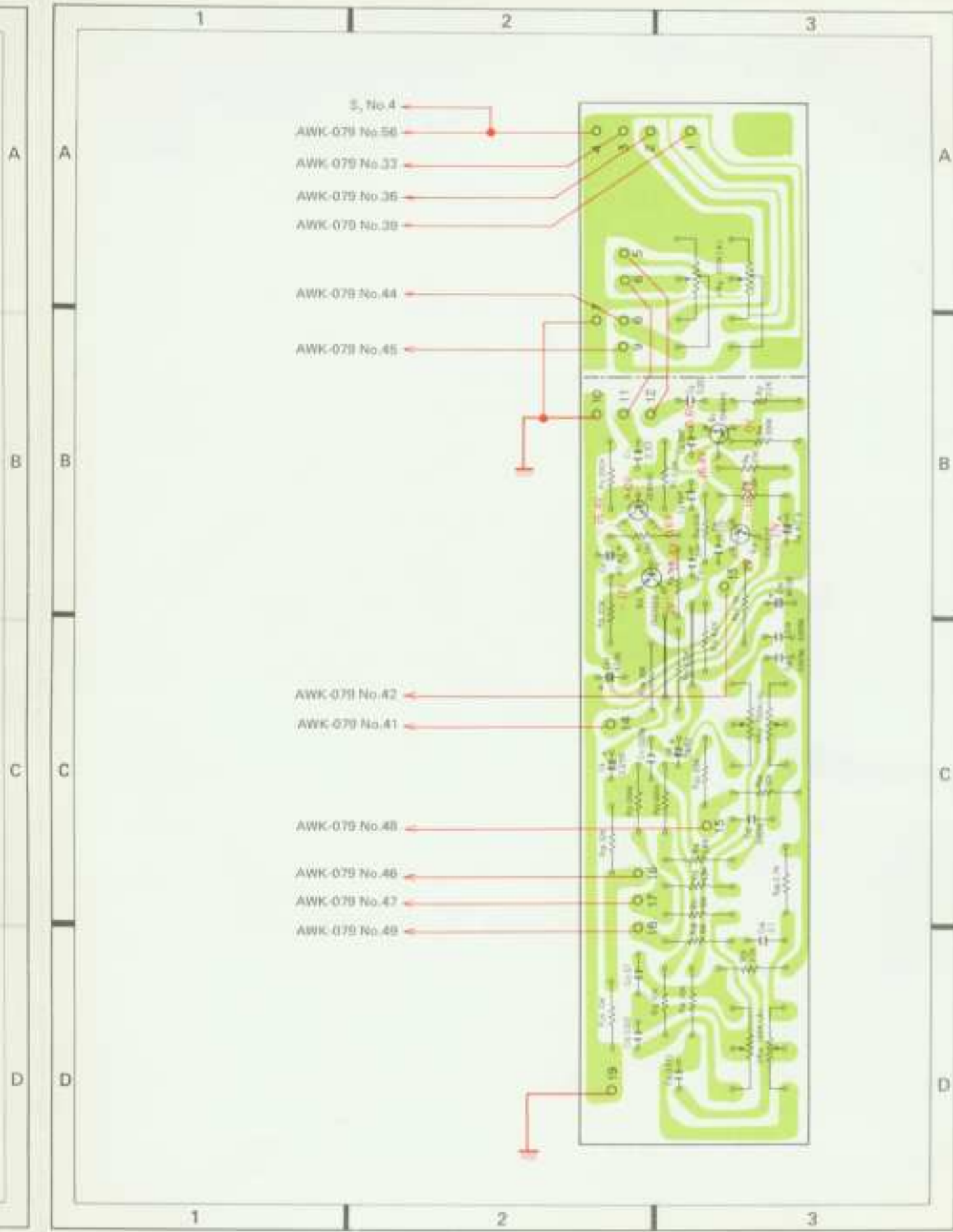
B

C

D

11.3 CONTROL AMPLIFIER ASSEMBLY (AWG-047)





S, No 4

AWK-079 No 38

AWK-079 No 33

AWK-079 No 36

AWK-079 No 39

AWK-079 No 44

AWK-079 No 45

AWK-079 No 42

AWK-079 No 41

AWK-079 No 48

AWK-079 No 46

AWK-079 No 47

AWK-079 No 49

Parts List of Control Amplifier Assembly (AWG-047)

SEMICONDUCTORS

Symbol	Description	Part No.
Q1	Transistor	2SA640-E or F
Q2	Transistor	2SA640-E or F
Q3	Transistor	2SC1222-E or F
Q4	Transistor	2SC1222-E or F

RESISTORS

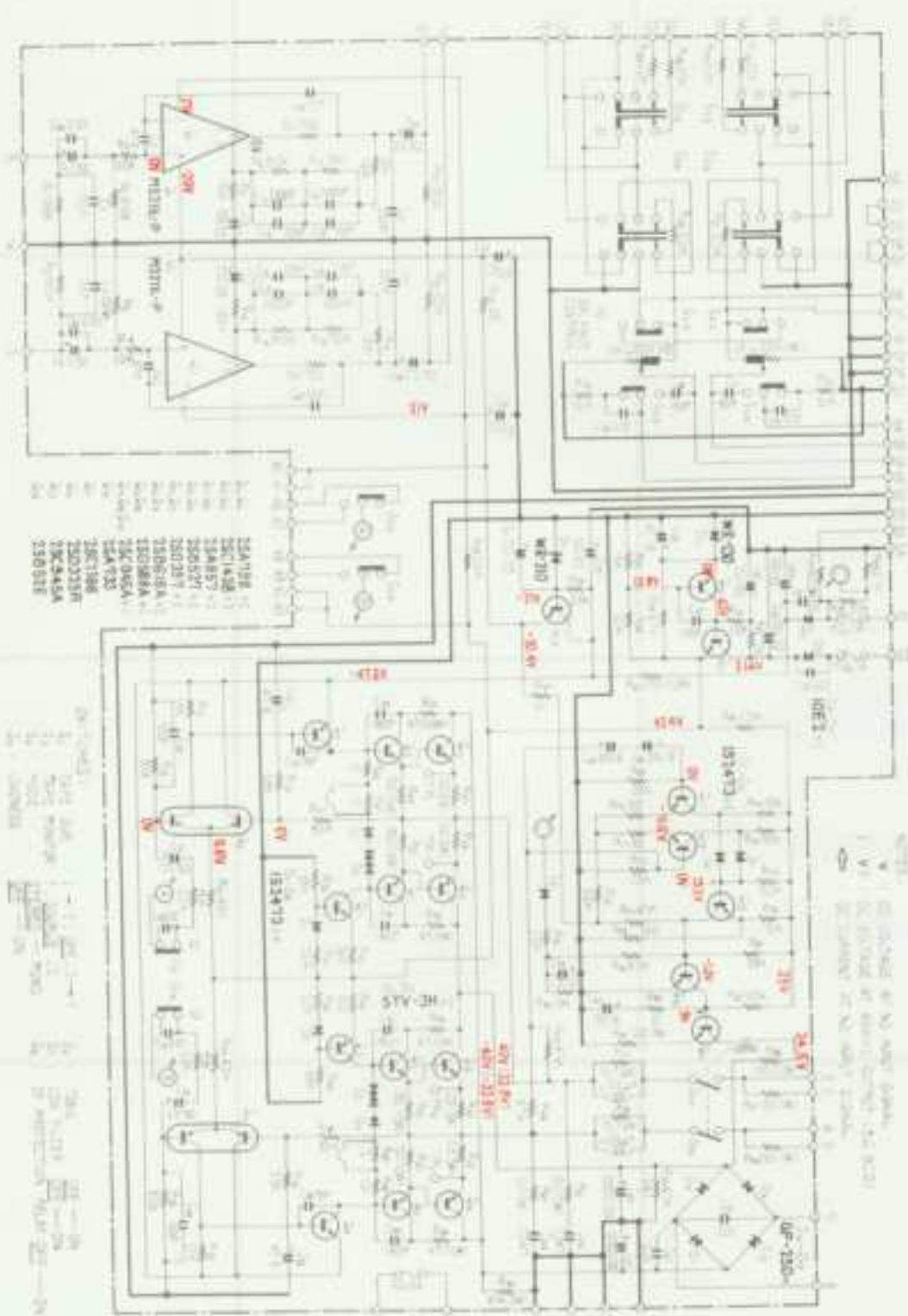
Symbol	Description	Part No.
VR2	Variable 100k 32-step (VOLUME)	ACV-162
VR3	Variable 100k-A (BASS)	ACV-138
VR4	Variable 100k-A (TREBLE)	ACV-138
R1	Carbon film 2.2k	RD1PS 222J
R2	Carbon film 2.2k	RD1PS 222J
R3	Carbon film 200k	RD1PS 204J NL
R4	Carbon film 200k	RD1PS 204J NL
R5	Carbon film 27k	RD1PS 273J
R6	Carbon film 27k	RD1PS 273J
R7	Carbon film 1.6k	RD1PS 162J
R8	Carbon film 1.6k	RD1PS 162J
R9	Carbon film 51k	RD1PS 513J NL
R10	Carbon film 51k	RD1PS 513J NL
R11	Carbon film 6.2k	RD1PS 622J
R12	Carbon film 6.2k	RD1PS 622J
R13	Carbon film 6.8k	RD1PS 682J
R14	Carbon film 6.8k	RD1PS 682J
R15	Carbon film 10k	RD1PS 103J
R16	Carbon film 10k	RD1PS 103J
R17	Carbon film 10k	RD1PS 103J
R18	Carbon film 10k	RD1PS 103J
R19	Carbon film 33k	RD1PS 333J
R20	Carbon film 33k	RD1PS 333J
R21	Carbon film 200k	RD1PS 204J
R22	Carbon film 200k	RD1PS 204J
R23	Carbon film 2.7k	RD1PS 272J
R24	Carbon film 2.7k	RD1PS 272J
R25	Carbon film 10k	RD1PS 103J
R26	Carbon film 10k	RD1PS 103J
R27	Carbon film 1k	RD1PS 102J
R28	Carbon film 300	RD1PS 301J

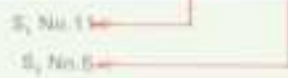
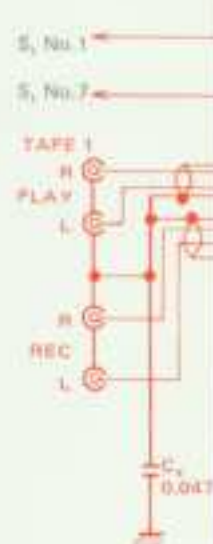
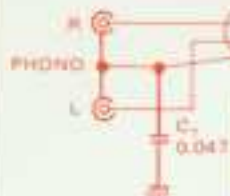
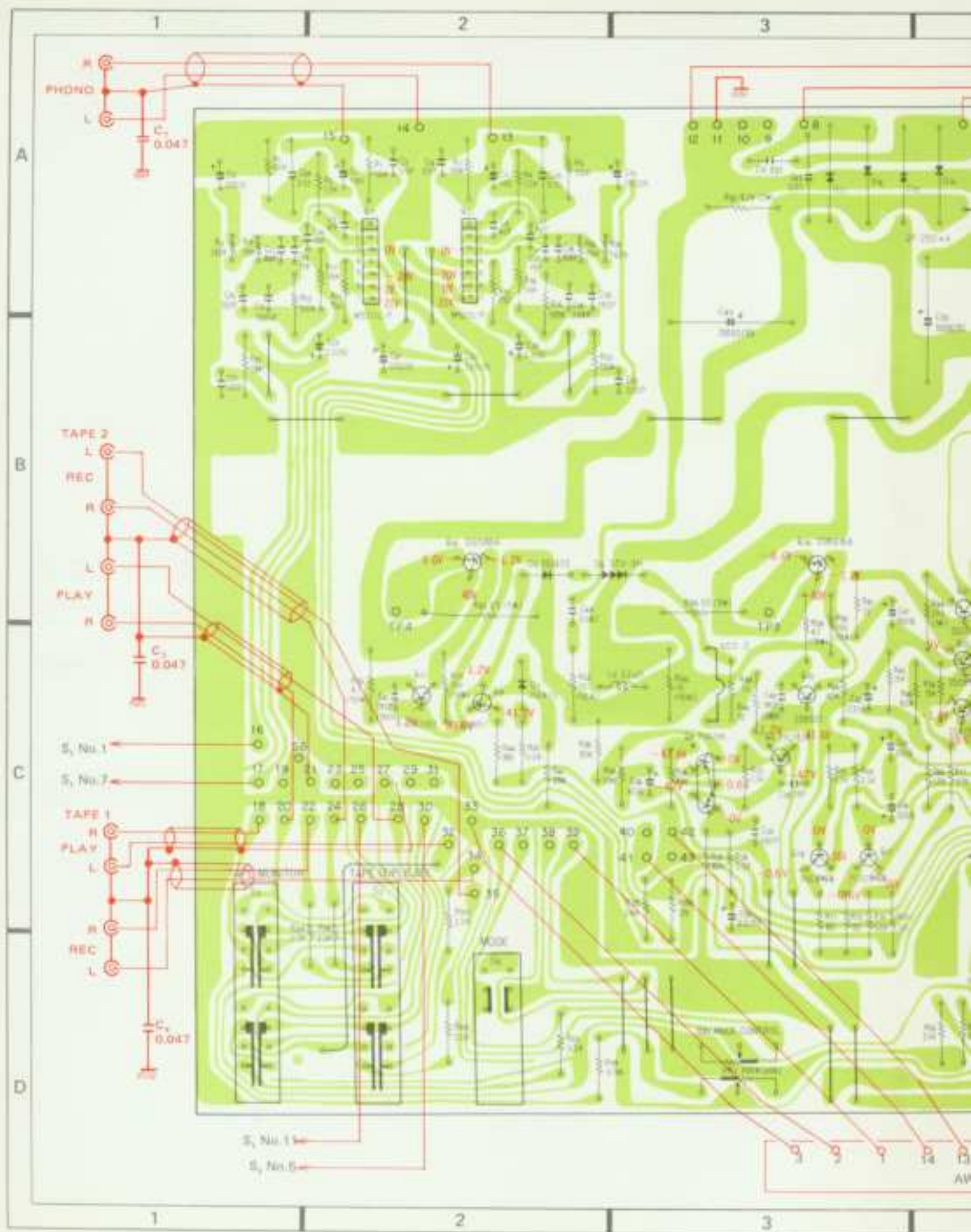
CAPACITORS

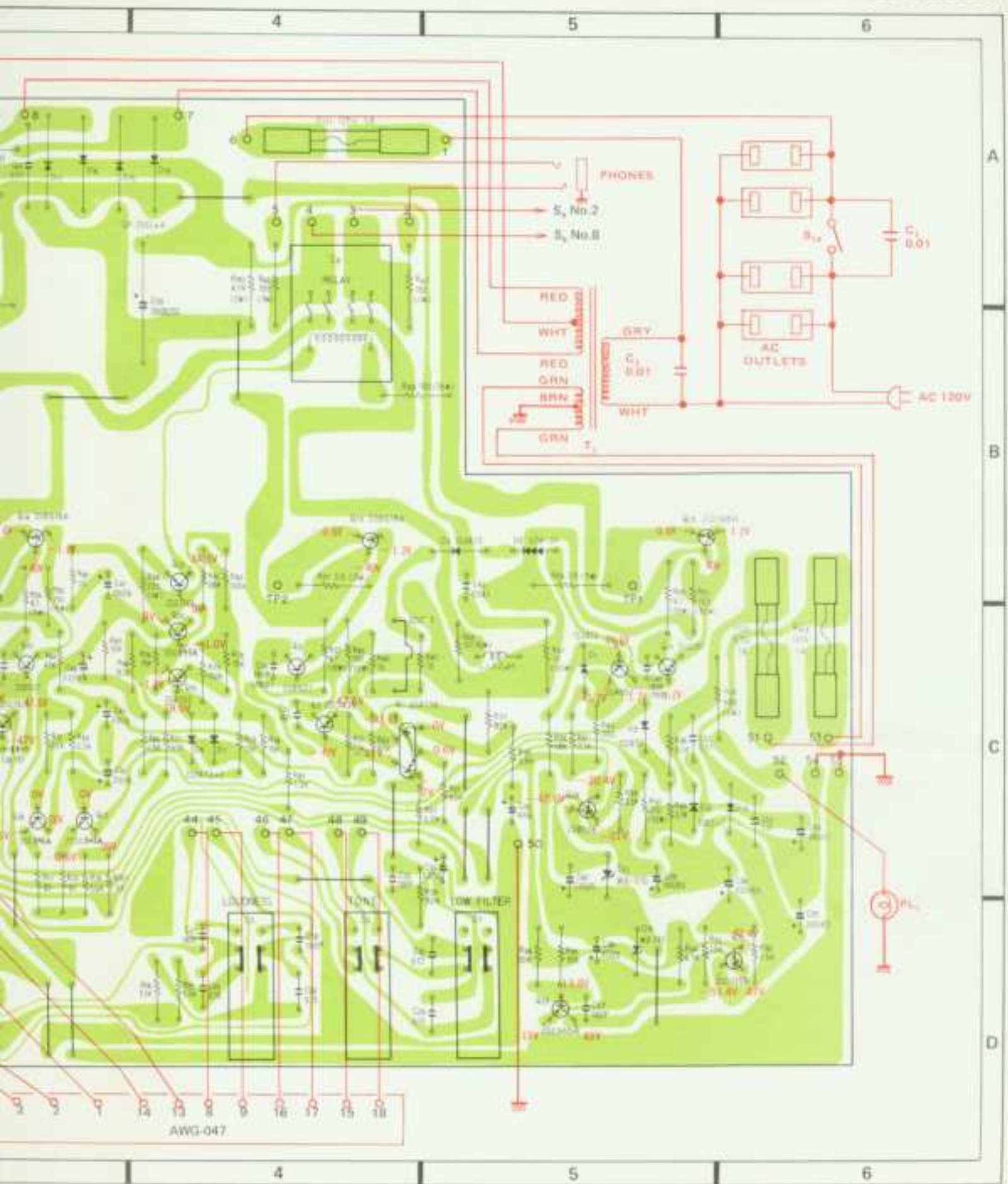
Symbol	Description	Part No.
C1	Metallized mylar 0.33 100V	ACE-009
C2	Metallized mylar 0.33 100V	ACE-009
C3	Ceramic 39p 50V	CC05L 390K 50
C4	Ceramic 39p 50V	CC05L 390K 50
C5	Electrolytic 47 6V	CEANL 470P 6

Symbol	Description	Part No.
C6	Electrolytic 47 6V	CEANL 470P 6
C7	Ceramic 27p 50V	CC05L 270K 50
C8	Ceramic 27p 50V	CC05L 270K 50
C9	Electrolytic 3.3 50V	CEANL 3R3P 50
C10	Electrolytic 3.3 50V	CEANL 3R3P 50
C11	Ceramic 1800p 50V	CKDYB 182K 50
C12	Ceramic 1800p 50V	CKDYB 182K 50
C13	Ceramic 5600p 50V	CKDYB 562K 50
C14	Ceramic 5600p 50V	CKDYB 562K 50
C15	Mylar 0.022 50V	COMA 222K 50
C16	Mylar 0.022 50V	COMA 222K 50
C17	Mylar 0.1 50V	COMA 104K 50
C18	Mylar 0.1 50V	COMA 104K 50
C19	Electrolytic 47 25V	CEA 470P 25
C20	Electrolytic 47 25V	CEA 470P 25

11.4 AF AMPLIFIER ASSEMBLY (AWK-079)







AWG-047

Parts List of AF Amplifier Assembly (AWK-079)

SEMICONDUCTORS

Symbol	Description	Part No.
Q1	IC	M5211L-P
Q2	IC	M5211L-P
Q3	Transistor	2SA798-F or G
Q4	Transistor	2SA798-F or G
Q5	Transistor	2SC1438-V or B
Q6	Transistor	2SC1438-V or B
Q7	Transistor	2SA857-V or B
Q8	Transistor	2SA857-V or B
Q9	Transistor	2SB527-D or C
Q10	Transistor	2SB527-D or C
Q11	Transistor	2SD357-D or C
Q12	Transistor	2SD357-D or C
Q13	Transistor	2SB618A-R or S
Q14	Transistor	2SB618A-R or S
Q15	Transistor	2SD589A-R or S
Q16	Transistor	2SD589A-R or S
Q17	Transistor	2SC945A-Q or R
Q18	Transistor	2SC945A-Q or R
Q19	Transistor	2SA733-Q or R
Q20	Transistor	2SC945A-Q or R
Q21	Transistor	2SC1166-Y or D 2SC1384-R or S
Q22	Transistor	2SD325R-D or E
Q23	Transistor	2SC945A-Q or R
Q24	Transistor	2SB526-C or D
D1	Diode	1S2473
D2	Diode	1S2473
D3	Diode	1S2473
D4	Diode	1S2473
D5	Varistor	STV-3H-Y
D6	Varistor	STV-3H-Y
D7	Diode	1S2473
D8	Diode	1S2473
D9	Diode	1S2473
D10	Zener diode	WZ-130
D11	Zener diode	WZ-210
D12	Diode	10E2 (1S1886) (S1801-02)
D13	Diode	10E2 (1S1886) (S1801-02)
D14	Diode	GP-25D (3002) (ERC01-02)
D15	Diode	GP-25D (3002) (ERC01-02)
D16	Diode	GP-25D (3002) (ERC01-02)

Symbol	Description	Part No.
D17	Diode	GP-25D (3002) (ERC01-02)

SWITCHES

Symbol	Description	Part No.
S2	Lever switch (TAPE MONITOR)	ASK-118
S3	Lever switch (TAPE DUPLICATOR)	ASK-118
S4	Lever switch (MODE)	ASK-089
S5	Lever switch (LOUDNESS)	ASK-089
S6	Lever switch (TONE)	ASK-089
S7	Lever switch (LOW FILTER)	ASK-089
S8	Relay	ASR-023

COILS

Symbol	Description	Part No.
L1	Choke coil 2.2 μ H	T63-009
L2	Choke coil 2.2 μ H	T63-009

RESISTORS

Symbol	Description	Part No.
VR1	Variable resistor 100k-HS (VOLUME)	ACV-135
R1	Carbon film 100k	RD%PS 104J NL
R2	Carbon film 100k	RD%PS 104J NL
R3	Carbon film 2.2k	RD%PS 222J
R4	Carbon film 2.2k	RD%PS 222J
R5	Carbon film 100k	RD%PS 104J NL
R6	Carbon film 100k	RD%PS 104J NL
R7	Vacancy
R8	Vacancy
R9	Metal film 1.62k 1/2W	RN%SQ 1621F
R10	Metal film 1.62k 1/2W	RN%SQ 1621F
R11	Carbon film 750	RD%PS 751J
R12	Carbon film 750	RD%PS 751J
R13	Metal film 910k 1/2W	RN%PT 9103F
R14	Metal film 910k 1/2W	RN%PT 9103F
R15	Metal film 75k 1/2W	RN%SQ 7502F
R16	Metal film 75k 1/2W	RN%SQ 7502F
R17	Carbon film 1.6k	RD%PS 162J
R18	Carbon film 1.6k	RD%PS 162J
R19	Vacancy
R20	Vacancy
R21	Carbon film 100k	RD%PS 104J
R22	Carbon film 100k	RD%PS 104J

Symbol	Description
R23	Carbon film
R24	Carbon film
R25	Carbon film
R26	Carbon film
R27	Carbon film
R28	Carbon film
R29	Carbon film
R30	Carbon film
R31	Carbon film
R32	Carbon film
R33	Carbon film
R34	Carbon film
R35	Carbon film
R36	Carbon film
R37	Carbon film
R38	Carbon film
R39	Carbon film
R40	Carbon film
R41	Carbon film
R42	Carbon film
R43	Carbon film
R44	Carbon film
R45	Carbon film
R46	Carbon film
R47	Carbon film
R48	Carbon film
R49	Carbon film
R50	Carbon film
R51	Carbon film
R52	Carbon film
R53	Carbon film
R54	Carbon film
R55	Carbon film
R56	Carbon film
R57	Wire
R58	Wire
R59	Wire
R60	Wire
R61	Carbon film
R62	Carbon film
R63	Carbon film
R64	Carbon film
R65	Carbon film
R66	Carbon film
R67	Metal film
R68	Metal film
R69	Carbon film
R70	Carbon film
R71	Carbon film
R72	Carbon film
R73	Carbon film

Symbol	Description	Part No.
R23	Carbon film 3.3k	RD%PS 332J
R24	Carbon film 3.3k	RD%PS 332J
R25	Carbon film 5.1k	RD%PS 512J
R26	Carbon film 5.1k	RD%PS 512J
R27	Carbon film 2.2k	RD%PS 222J
R28	Carbon film 2.2k	RD%PS 222J
R29	Carbon film 82k	RD%PS 823J
R30	Carbon film 82k	RD%PS 823J
R31	Carbon film 1.1k	RD%PS 112J
R32	Carbon film 1.1k	RD%PS 112J
R33	Carbon film 43k	RD%PS 433J
R34	Carbon film 43k	RD%PS 433J
R35	Carbon film 3.9k	RD%PS 392J
R36	Carbon film 3.9k	RD%PS 392J
R37	Carbon film 82k	RD%PS 823J
R38	Carbon film 82k	RD%PS 823J
R39	Carbon film 68k	RD%PS 683J
R40	Carbon film 68k	RD%PS 683J
R41	Carbon film 2.2k	RD%PS 222J
R42	Carbon film 2.2k	RD%PS 222J
R43	Carbon film 300	RD%PS 301J
R44	Carbon film 300	RD%PS 301J
R45	Carbon film 10	RD%PS 100J
R46	Carbon film 10	RD%PS 100J
R47	Carbon film 12	RD%PS 120J
R48	Carbon film 12	RD%PS 120J
R49	Carbon film 150 1/2W	RD%PS 151J
R50	Carbon film 150 1/2W	RD%PS 151J
R51	Carbon film 150 1/2W	RD%PS 151J
R52	Carbon film 150 1/2W	RD%PS 151J
R53	Carbon film 4.7 1/2W	RD%PSF 4R7J
R54	Carbon film 4.7 1/2W	RD%PSF 4R7J
R55	Carbon film 4.7 1/2W	RD%PSF 4R7J
R56	Carbon film 4.7 1/2W	RD%PSF 4R7J
R57	Wire wound 0.5 5W	RT58 0R5K
R58	Wire wound 0.5 5W	RT58 0R5K
R59	Wire wound 0.5 5W	RT58 0R5K
R60	Wire wound 0.5 5W	RT58 0R5K
R61	Carbon film 10 1/2W	RD%PSF 100J
R62	Carbon film 10 1/2W	RD%PSF 100J
R63	Carbon film 47k	RD%PS 473J
R64	Carbon film 47k	RD%PS 473J
R65	Carbon film 10 1/2W	RD%PSF 100J
R66	Carbon film 10 1/2W	RD%PSF 100J
R67	Metal oxide 150 1W	RS1P 151K
R68	Metal oxide 150 1W	RS1P 151K
R69	Carbon film 2.2k	RD%PS 222J
R70	Carbon film 82	RD%PS 820J
R71	Carbon film 82	RD%PS 820J
R72	Carbon film 2.2k	RD%PS 222J
R73	Carbon film 15k	RD%PS 153J

Symbol	Description	Part No.
R74	Carbon film 15k	RD%PS 153J
R75	Carbon film 150k	RD%PS 154J
R76	Carbon film 5.6k	RD%PS 562J
R77	Carbon film 4.7k	RD%PS 473J
R78	Carbon film 15k	RD%PS 153J
R79	Carbon film 15k	RD%PS 153J
R80	Carbon film 8.2k	RD%PS 822J
R81	Carbon film 68k	RD%PS 683J
R82	Carbon film 22	RD%PS 220J
R83	Carbon film 100k	RD%PS 104J
R84	Metal film 220 1W	RS1P 221J
R85	Carbon film 15k	RD%PS 153J
R86	Carbon film 1.5k	RD%PS 152J
R87	Carbon film 1.3k	RD%PS 132J
R88	Carbon film 100 1/2W	RD%PSF 101J
R89	Carbon film 2.7k	RD%PS 272J
R90	Carbon film 5.1k	RD%PS 512J
R91	Metal film 680 2W	RS2P 681J
R92	Carbon film 1.5k	RD%PS 153J
R93	Carbon film 1.5k	RD%PS 153J
R94	Carbon film 4.7k	RD%PS 472J
R95	Carbon film 15k	RD%PS 153J
R96	Carbon film 30k	RD%PS 303J
R97	Carbon film 270 1/2W	RD%PSF 271J
R98	Carbon film 3.9k	RD%PS 392J
R99	Carbon film 2.4k	RD%PS 242J
R100	Carbon film 39	RD%PS 390J
R101	Metal film 4.7k 2W	RS2P 472J
R102	Metal film 4.7k 2W	RS2P 472J
R103	Carbon film 2.2k	RD%PS 222J
R104	Carbon film 2.2k	RD%PS 222J
R105	Carbon film 2.2k	RD%PS 222J
R106	Carbon film 2.2k	RD%PS 222J
R107	Carbon film 3k	RD%PS 302J

CAPACITORS

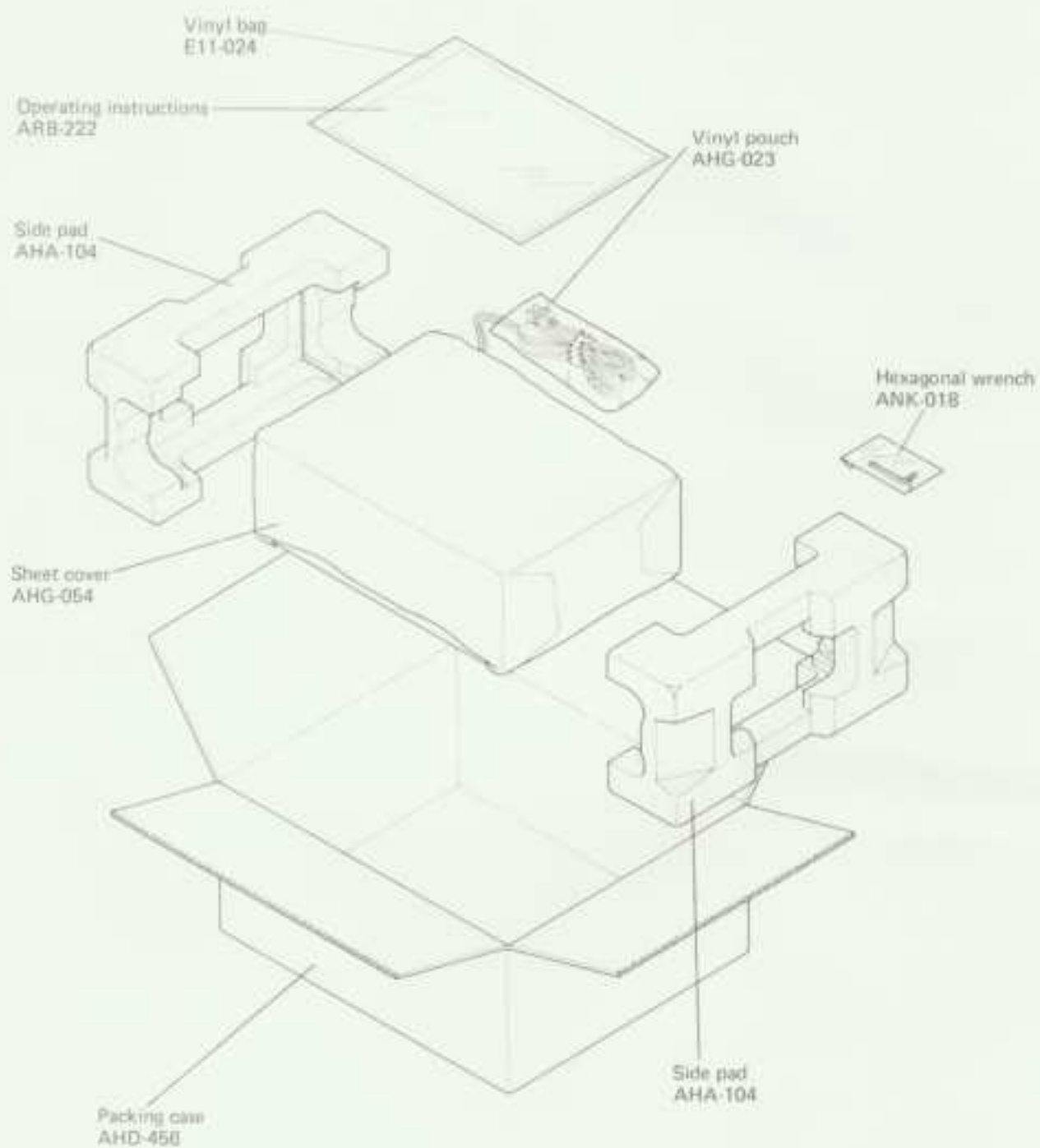
Symbol	Description	Part No.
C1	Electrolytic 1 50V	CEANL 010P 50
C2	Electrolytic 1 50V	CEANL 010P 50
C3	Ceramic 100p 50V	CCDSL 121K 50
C4	Ceramic 120p 50V	CCDSL 121K 50
C5	Ceramic 47p 50V	CCDSL 470K 50
C6	Ceramic 47p 50V	CCDSL 470K 50
C7	Vacancy
C8	Vacancy
C9	Electrolytic 220 25V	CEA 221P 25
C10	Electrolytic 220 25V	CEA 221P 25
C11	Vacancy
C12	Vacancy
C13	Polystyrene 3300p 50V	CO5A 3320 50

Symbol	Description	Part No.
C14	Polystyrene 3300p 50V	CQSA 332G 50
C15	Ceramic 150p 50V	CCDSL 151K 50
C16	Ceramic 150p 50V	CCDSL 151K 50
C17	Polystyrene 1000p 50V	CQSA 102G 50
C18	Polystyrene 1000p 50V	CQSA 102G 50
C19	Ceramic 15p 50V	CCDSL 150K 50
C20	Ceramic 15p 50V	CCDSL 150K 50
C21	Ceramic 220p 50V	CCDSL 221K 50
C22	Ceramic 220p 50V	CCDSL 221K 50
C23	Electrolytic 2.2 50V	CEANL 2R2P 50
C24	Electrolytic 2.2 50V	CEANL 2R2P 50
C25	Mylar 0.15 50V	QOMA 154K 50
C26	Mylar 0.15 50V	QOMA 154K 50
C27	Ceramic 180p 50V	CCDSL 181K 50
C28	Ceramic 180p 50V	CCDSL 181K 50
C29	Mylar 0.12 50V	QOMA 124K 50
C30	Mylar 0.12 50V	QOMA 124K 50
C31	Electrolytic 2.2 50V	CEANL 2R2P 50
C32	Electrolytic 2.2 50V	CEANL 2R2P 50
C33	Ceramic 100p 50V	CCDSL 101K 50
C34	Ceramic 100p 50V	CCDSL 101K 50
C35	Electrolytic 47 6V	CEA 470P 6
C36	Electrolytic 47 6V	CEA 470P 6
C37	Ceramic 18p 50V	CCDSL 180K 50
C38	Ceramic 18p 50V	CCDSL 180K 50
C39	Ceramic 180p 500V	CCDSL 181K 500
C40	Ceramic 180p 500V	CCDSL 181K 500
C41	Ceramic 180p 500V	CCDSL 181K 500
C42	Ceramic 180p 500V	CCDSL 181K 500
C43	Ceramic 0.047 50V	CKDYF 473Z 50
C44	Ceramic 0.047 50V	CKDYF 473Z 50
C45	Electrolytic 330 6V	CEA 331P 6
C46	Electrolytic 330 6V	CEA 331P 6
C47	Electrolytic 100 16V	CEA 101P 16
C48	Electrolytic 2.2 10V	ACH-317
C49	Electrolytic 10000 50V	ACH-062
C50	Electrolytic 10000 50V	ACH-062
C51	Ceramic 0.01 150V	ACG-004
C52	Ceramic 0.01 150V	ACG-004
C53	Ceramic 0.01 150V	ACG-004
C54	Electrolytic 330 63V	CEA 331P 63
C55	Electrolytic 330 63V	CEA 331P 63
C56	Electrolytic 220 63V	CEA 221P 63
C57	Ceramic 100p 50V	CCDSL 101K 50
C58	Electrolytic 47 25V	CEA 470P 25
C59	Electrolytic 100 63V	CEA 101P 63
C60	Electrolytic 220 25V	CEA 221P 25
C61	Electrolytic 220 25V	CEA 221P 25
C62	Electrolytic 220 25V	CEA 221P 25
C63	Ceramic 0.01 150V	ACG-004
C64	Metallized mylar 0.33 100V	ACE-009
C65	Metallized mylar 0.33 100V	ACE-009
C66	Ceramic 10p 50V	CCDSL 100F 50
C67	Ceramic 10p 50V	CCDSL 100F 50

OTHERS

Symbol	Description	Part No.
	Spacer	AEC-212
	Micro wafer	AEC-288
	Insulator spacer	AKH-008
	Fuse clip	AKR-013
	Fuse clip	AKR-030
	Screw 2.5x10	ASA-117
	Washer faced nut M8	ASN-024

12. PACKING



PIONEER ELECTRONIC CORPORATION

4-1, Meguro 1-Chome, Meguro-ku, Tokyo 153, Japan

U.S. PIONEER ELECTRONICS CORPORATION

75 Oxford Drive, Moonachie, New Jersey 07074, U.S.A.

PIONEER ELECTRONIC (EUROPE) N.V.

Luithagen-Haven 9, 2030 Antwerp, Belgium

PIONEER ELECTRONICS AUSTRALIA PTY. LTD.

178-184 Boundary Road, Braeside, Victoria, 3195, Australia