

CASSETTE TAPE DECK

CT-F950

OPERATING INSTRUCTIONS

KU
KC

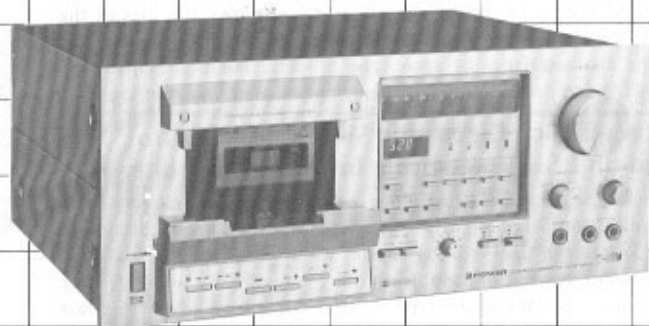

CONTENTS

Features	2
Connections	3
Precautions	3
Front Panel Facilities	4
Basic Operations	6
Recording	8
Microphone Recording	10
Playback	11
Operations with the Timer	12
Maintenance	12
The Dolby NR System	13
Cassette Tapes	14
Specifications	15
Troubleshooting	16
Schematic Diagram	Insertion
Leading brands of tapes	Insertion

IMPORTANT NOTICE

The serial number for this equipment is located on the opposite panel on the controls.

Please write this serial number on your enclosed warranty card and keep in a secure area. This is for your security.

WARNING: TO PREVENT FIRE OR SHOCK HAZARD, DO NOT EXPOSE THIS APPLIANCE TO RAIN OR MOISTURE.

FEATURES

Transport Section Engineered for Stable Tape Run

This deck features the closed loop dual capstan system whereby a capstan is stationed on either side of the heads. This system maintains a stable contact between the heads and the tape so that the tape travels at a constant tension all the time, and it also helps to suppress dropouts in the tape and fluctuations in the level. Another important point is that external vibration transmitted from the reel bases and tape guides to the tape is kept down to the minimum for a marked reduction in the modulation noise and both recording and playback which are faithful to the original sound.

The DC servo motor which provides a stable rotational speed is combined with the ultra-precision-engineered capstans and good dynamic balance flywheels to yield a truly superior tape transport performance, and a great improvement in the wow and flutter characteristics.

Yet another prime feature is the mechanical governor motor with its powerful rotation torque and less ripple. This is used for the take-up operations, and enables reliable fast forward and rewind operations.

Three-Head System with Recording/Playback Combination Head

This deck features a combination head—which is an amalgamation of a playback head and a recording head displaying outstanding phase characteristics, frequency response, signal-to-noise ratio and a host of other superior characteristics—in a single packaged case. In addition to the superb high-frequency response and wear-resistance, Pioneer's newly developed ferrite is used for the head and this overcomes the traditional weak point of ordinary ferrite which left something to be desired in their handling of high input signals. The result is a head which not only draws out the best in the performance of chrome tapes and ferrichrome tapes but also copes admirably with metal tapes which excel in dealing with high input signals. All this translates into high-quality recording and playback. Another big attraction is that the combination head allows the recording to be monitored virtually in real time when the monitor switch is selected.

Built-In Microprocessor Gives Digital Level Indication and Tape Counter

This deck contains a 'brain': a 4-bit parallel processing 1-chip microprocessor which is the secret behind the digital indication of the recording and playback levels on the fluorescent display tubes. The level meter extends to cover a range from -20dB up to +7dB. Indication between -4dB and +7dB is in 1dB steps which allows high-level signals movements to be grasped at a glance and the recording level to be set just as easily.

The level meter can serve to display normal VU readout, or it can be made to function as a peak meter to detect accurately pulse-like sound. Moreover, while the meter is working as a peak meter, the maximum level of the program source can be held on the display simply by depressing the peak hold switch. All these functions are made possible by three meter switches. If they are selected in accordance with the program source which is being recorded, you will be assured of faithful recordings which feature a good signal-to-noise ratio even with program sources with wide dynamic ranges.

The tape counter is another dramatic new feature. Instead of the usual mechanically rotating figures, it comes in the form of a 3-digit 'digitron' display tube which makes use of the built-in microprocessor and its counter function to detect the pulses generated as the reel bases rotate. These pulses are translated into digits which are then displayed. This electronic tape counter is extremely handy.

Equalizer Circuit and Bias Control Mechanism Aimed at Making the Most of the Tapes' Characteristics

The most is made of not only metal tapes but also chrome tapes, ferrichrome tapes and standard tapes with the tape selector which selects the equalizer and bias corresponding to the type of tape used, and also with the bias control which allows the bias of the tape to be finely adjusted. Adjustments can therefore be made to suit the characteristics of each type of tape. The bias control can also be used to produce the frequency response of your preference.

Feather-Touch Electronic Mechanical Control Based on LSI (Large-Scale Integrated Circuitry)

The tape transport selector mechanism employs electronic mechanical control based on a dual-in-line 24-pin C MOS LSI circuit. You can set the deck to any mode, whether playback, recording, fast forward, rewind or stop, from one mode directly with a feather touch operation. When the tape transport is changed over from fast forward to play or from fast forward to rewind by the commands from the LSI's program, the deck is put through the stop mode automatically. This means that the tape is never harmed in any way. Even when two mode buttons are depressed accidentally together, the deck is set to the stop mode first and so there is absolutely no fear of a breakdown of malfunction.

Microprocessor with Six Different Programs in Its Memory

The LSI accommodates six different programs: the MEMORY STOP which automatically rewinds the tape to the position where the tape counter was set to '000'; the MEMORY PLAY which commences playback again after the tape has been stopped; the REPEAT END which repeats tape playback automatically from the tape start point; the COUNTER REPEAT which repeats the tape playback from the start of the program where the tape counter was set during playback to '000' up to the end of the tape rewind; as well as the unattended recording and wake-up playback functions which can be employed when you hook up an optional timer to the deck.

VARIETY OF ACCESSORY MECHANISMS

Dolby* Noise Reduction System:

A newly developed low-distortion IC is used for the Dolby NR system. This serves to reduce greatly the irritating noise heard when you play back a tape, and it does this without impairing the sound quality of the original program source. This helps to increase the dynamic range, and it allows recordings and playback with a good signal-to-noise ratio.

Input Selector Switch:

This switch can be selected between the program source connected to the rear panel input jacks and the sound from a microphone.

Output Level Controls with a Click-stop Position for Easy Pinpointing of the Regular Playback Level:

The output (playback level) controls can be used to vary the output level continuously and they are also coupled to the level meter. This means that it is possible to check the output level on the meter, regardless of the strength of the recording level. When the controls are set to their click-stop position, the regular playback level can also be checked.

② *Manufactured under license from Dolby Laboratories.

*Dolby and  are trademarks of Dolby Laboratories.

CONNECTIONS

Connect the CT-F950's terminals (OUTPUT-INPUT) to the tape terminals on the receiver (or stereo amplifier) with the accessory cords.

The upper terminal is for the left channel and the lower for the right channel.

Connections for playback: connect the TAPE PLAY input terminals on the receiver to the CT-F950's OUTPUT (PLAY) terminals.

Connections for recording: connect the receiver's TAPE REC output terminals to the CT-F950's INPUT (REC) terminals.

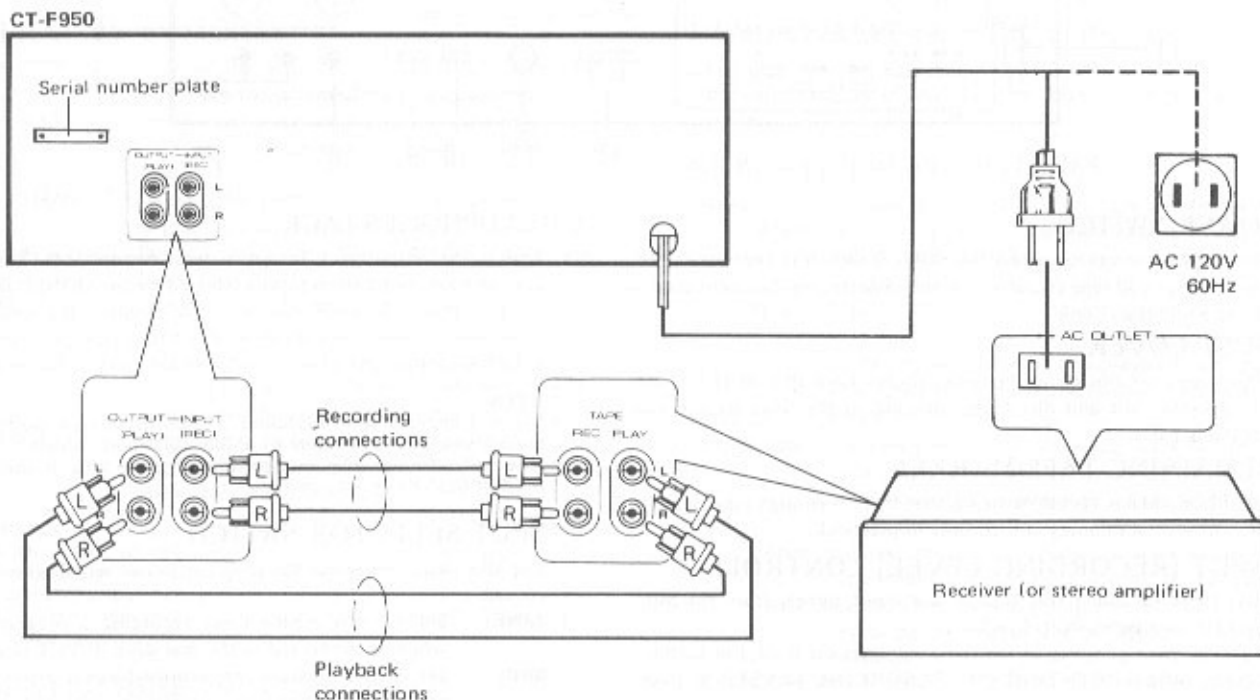

PRECAUTIONS

HANDLING THE POWER CORD

- Always take hold of the plug to unplug it from the power outlet; do not unplug it by pulling on the cord. The cord may be damaged if you keep pulling on it.
- Do not handle the power cord with wet hands. This is extremely dangerous because you may get an electric shock.

PRECAUTIONS FOR USE

- Under no circumstances should the bonnet be removed, and the internal parts touched or modified in any way. Pioneer will not be held responsible in the event of a deterioration in performance or a breakdown if the cassette deck is modified in any way.

- Do not bring screwdrivers and other metal objects or magnets near the heads since you may damage and magnetize them.

KEEP THE HEAD SECTION CLEAN

The heads, capstan and pinch roller get dirty very easily since they come in contact with the tape. For further details on cleaning the head section, refer to page 12 and the section on "MAINTENANCE."

Moisture forms in the operating sections of this model and the model's performance will be impaired if the model is brought from cool surroundings into a warm room or if the temperature of the room rises suddenly.

To prevent impairing performance, let the model stand in its new surroundings for about an hour before switching it on, or ensure that the room temperature rises gradually.

FRONT PANEL FACILITIES

Cassette compartment illumination

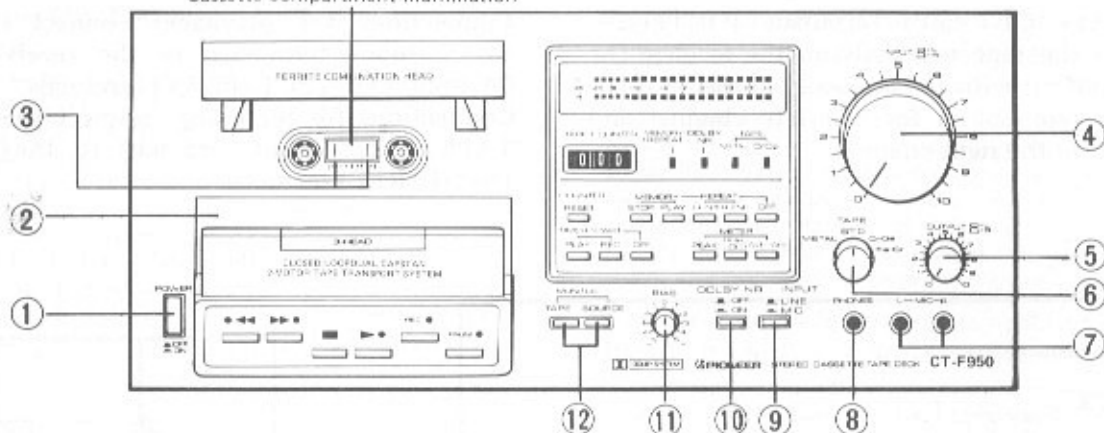

① POWER SWITCH

The power comes on when the POWER switch is depressed. The level meter and tape counter, and the cassette compartment illumination will then come on.

② DUST COVER

When you are not using the deck, always keep this cover in place to prevent dust and dirt from adhering to the head section and rotating parts.

③ REMAINING TAPE MARKER

If this marker is visible, it means that there is enough tape remaining for several minutes of recording or playback.

④ INPUT (RECORDING LEVEL) CONTROLS

Use these to adjust the level of the input signals from the MIC jacks or rear panel INPUT jacks.

Turning these controls to the right increases the level. For further details, refer to "SETTING THE RECORDING LEVEL" on page 9.

The controls are coupled to the left and right channels, but you can also use them to adjust the right channel (back) and the left channel (front) independently.

⑤ OUTPUT (PLAYBACK LEVEL) CONTROLS

Use these to adjust the output signal level during playback. Turning the controls to the right increases the level. The controls are coupled when turned but it is also possible to adjust the right channel (back) and the left channel (front) independently.

When playing back a reference tape (160 nwb/m), a reference playback level (0dB) is obtained with these controls set to the "6" click stop position.

⑥ TAPE SELECTOR

This selector allows the bias and equalizer characteristics to be selected during recording and the equalizer characteristics during playback in line with the type of tape you are using. For details, refer to "SETTING THE TAPE SELECTOR" on page 9.

METAL: For using metal tapes

STD: For using ordinary or LH tapes

CrO₂: For using chrome tapes

Fe-Cr: For using ferrichrome tapes

⑦ MIC JACKS

These are the input jacks for microphone recording. Plug the left channel microphone into the L jack and the right channel microphone into the R jack.

⑧ HEADPHONES JACK

This is the output jack for your stereo headphones. You will be able to hear sound from signals selected by the MONITOR switches. Use this jack when you want to monitor the quality of a recording or when you want to listen to a tape privately on the CT-F950. Adjust the output level with the OUTPUT controls.

NOTES:

- Use low-impedance headphones. If you use a high-impedance model, you will not be able to obtain sufficient volume.
- You will damage the microphone if you plug it into the HEADPHONES jack by mistake.

⑨ INPUT SELECTOR SWITCH

Use this switch to select the program source which you intend to record.

LINE: Set to this position for recording a program source which is connected to the rear panel INPUT jacks.

MIC: Set to this position for recording signals from a microphone, or microphones, connected to the MIC jacks.

NOTE:

You will be able to record signals from the INPUT jacks if the LINE switch is depressed even when the microphones are plugged into the MIC jacks.

⑩ DOLBY* NR SWITCH

Set this switch to ON for recording with the built-in Dolby noise reduction system and for the playback of tapes which have been recorded using the Dolby NR system.

⑪ BIAS CONTROL

Use this control to adjust the bias in accordance with the characteristics of the tape being used. It is set so that the center (click stop) position corresponds to the standard bias. For further details, refer to "ADJUSTING THE BIAS" on page 9.

⑫ MONITOR SWITCHES

You will be able to listen to the recorded signals (playback sound) if you depress the TAPE while you are recording a program. You will be able to listen to the signals (recording input) just before they are recorded if you depress the SOURCE. Use these switches to monitor your recording. Depress the TAPE during playback.



13 OPERATING SWITCHES

- ◀ (REW): Depress this switch to rewind the tape. (The tape will travel at high speed from right to left.)
- ▶▶ (FF): Depress this switch to send the tape forward at high speed. (The tape will travel from left to right.)
- (STOP): Depress this switch to stop the tape run and to release the operating switches.
- ▶ (PLAY): Depress this switch when playing back a tape. (The tape will travel from left to right.)
- REC: Depress this switch together with the PLAY switch for recording. This switch will not work when a cassette is not loaded or when the erasure prevention tabs of a loaded cassette have been broken off.
- PAUSE: Depress this switch to stop the tape temporarily during recording or playback. Depress it again to allow the tape to continue to travel as before.

NOTES:

- When any of the operating switches are depressed, the corresponding indicator (except STOP mode) will come on signifying that the deck is set to that respective mode.
- All the operating switches are released (OFF) to stop mode when the POWER switch is turned OFF.

14 COUNTER RESET BUTTON

Depress this button to reset the tape counter display to "000."

15 TAPE COUNTER

This indicates the position of the tape run. The counter reset to "000" when the power is switched on.

16 LEVEL METER

This indicates the input level during recording and the output level during playback. By operating the METER switches, it can be made to function as a peak meter, a peak hold meter or as a level meter. The input signal level is indicated when the MONITOR switch SOURCE has been depressed, and the playback output level is indicated when the MONITOR switch TAPE has been depressed.

17 DOLBY NR INDICATOR

This lights up when the DOLBY NR switch is set to ON and it indicates that a tape is being recorded or played back with the Dolby NR system.

18 TAPE INDICATORS

- METAL: This light comes on when the TAPE selector is set to METAL.
- CrO₂: This light comes on when the TAPE selector is set to CrO₂.

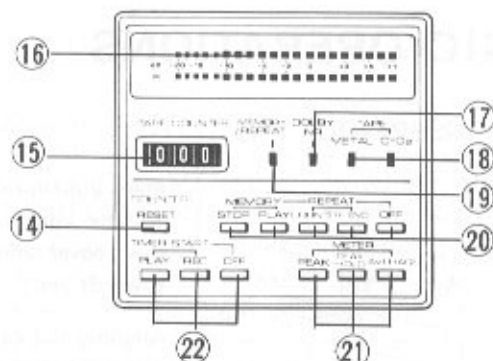

19 MEMORY/REPEAT INDICATOR

This indicator comes on when the MEMORY/REPEAT switches are depressed, signifying that the deck is set to the respective mode.

20 MEMORY/REPEAT SWITCHES

- MEMORY** : Depress this switch and the tape will be rewound to **STOP** that spot at which the tape counter was preset to "000" during rec/play, when the REW switch is depressed at any position you like.
- PLAY**: Depress this switch and the tape will be rewound to that spot at which the tape counter was preset to "000" during rec/play, and playback will start from that spot, when the REW switch is depressed at any position you like.
- REPEAT COUNTER**: Depress this switch when you want to play back a tape during playback or recording from the point at which the tape counter was set to "000" up to the end of the tape.
- END**: Depress this switch when you want to play back a tape from the beginning to the end of that tape.
- OFF**: Depress this switch during normal tape playback or recording to release the MEMORY and REPEAT switches.

For further details, refer to "REPEAT PLAYBACK FUNCTION."

21 METER SWITCHES

- PEAK**: The meter functions as a peak level meter when this switch is depressed.
 - PEAK HOLD**: The meter functions as a peak level meter and the highest level of the signals is indicated when this switch is depressed.
 - AVERAGE**: The meter functions as a level meter when this switch is depressed.
- For further details, refer to "SETTING THE RECORDING LEVEL" on page 9.

22 TIMER START SWITCHES

- Depress these switches when you are playing back or recording a tape with the use of a timer.
- REC**: When this switch is depressed, the deck will automatically be set to the recording mode at the preset timer time, and recording will begin. Use this switch for recording FM programs when you are out of the house or otherwise occupied.
 - PLAY**: When this switch is depressed, the deck will automatically be set to the playback mode at the preset timer time, and playback will begin. Use this switch for wake-up playback instead of an alarm clock.
 - OFF**: Always depress this switch when you do not intend to record or playback a tape using the timer. (This will release the REC and PLAY switches of TIMER START.)

BASIC OPERATIONS

TAPE INSERTION

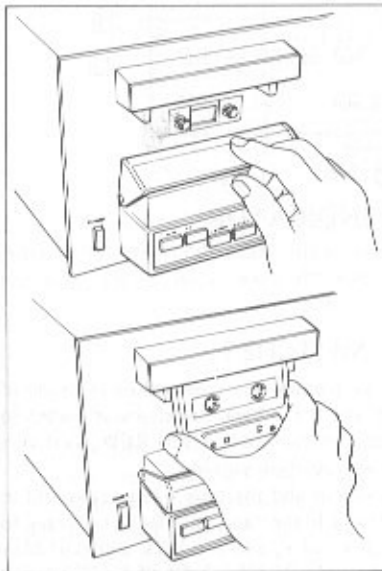

Place your forefinger on the edge of the dust cover and pull towards you.

Aligning the cassette tape with the guide, push upward and insert. When you want to remove the tape, pull it towards you.

NOTE:
Be sure not to take out cassette tape during tape running.

TAPE RUN

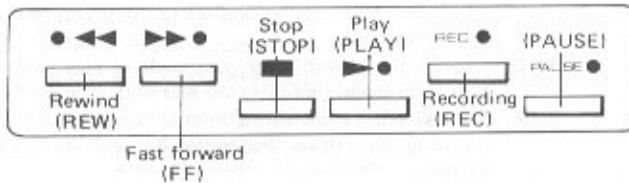

Play and record

1. Check that the tape is on the left reel.
2. The tape runs from left to right when the ► (PLAY) switch is depressed. If the REC switch is also depressed together with the PLAY switch, the deck will be set to the recording mode.

Fast forward

1. Check that the tape is on the left reel.
2. The tape runs from left to right at high speed when the ►► (FF) switch is depressed for a fast-forward operation.

Rewind

1. Check that the tape is on the right reel.
2. The tape runs from right to left at high speed when the ◀◀ (REW) switch is depressed, and the tape is rewound.

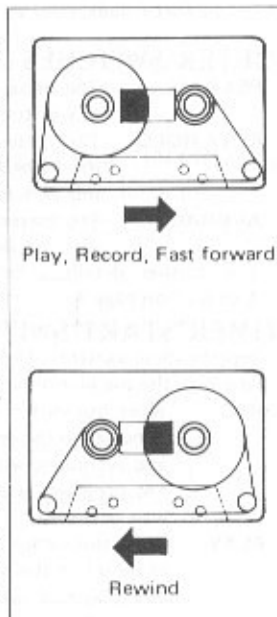

NOTES:

- You do not have to depress the STOP switch when selecting the next mode with the CT-F950.
- Do not depress more than one switch at a time except when recording and for PAUSE mode.

STOP OPERATION

Stopping the Tape

Depress the STOP switch to stop the tape travel. The operating switch indicators will go off, and this switch does not lock when depressed.

Using the Pause Switch

1. The tape will stop when the PAUSE switch is depressed while the tape is traveling (recording or playback), and the PAUSE indicator will come on.
2. When the PAUSE switch is depressed again, the tape will start traveling again (recording or playback).

NOTES:

1. When stopping the tape for a prolonged period of time, use the STOP switch.
2. When using a pre-recorded tape to re-record a program, bear in mind that the pre-recorded sound will sometimes not be erased at the place on the tape where you set the deck to the PAUSE mode.

The PAUSE switch comes in handy in the following instances:

- When the recording level is set.
- When you want to edit out some portions of a program during recording and then continue recording.

AUTO-STOP MECHANISM

The tape is automatically stopped by the auto-stop mechanism when the tape is completely wound onto one reel during each operating mode (Recording, Playback, Fast forward, Rewind) without the STOP switch having to be depressed. When this mechanism is actuated, the operating switch indicators will go off.

NOTE:

The auto-stop mechanism is actuated several seconds after the tape is fully rewound onto one reel.

Tape slack take-up mechanism

The CT-F950 employs two capstans and so any slack in the tape will impair the effectiveness of their performance.

To safeguard against this kind of malfunction, the deck is provided with a tape slack take-up mechanism which eliminates any slack. What happens is that when the cassette tape is loaded, it sets the deck to take up the slack.

If, however, there is a great deal of slack, use a pencil or similar object to take it up before you load the cassette tape (Refer to page 14).

REPEAT PLAYBACK FUNCTION

REPEAT SWITCHES

These switches enable you to listen repeatedly to tape playback.

REPEAT COUNTER SWITCH

1. Depress the REPEAT COUNTER switch to set it to on.
2. Depress the COUNTER RESET switch at the start of the program during playback or when recording which you want to hear repeatedly, and set the tape counter to "000."
3. When the tape is fully wound on to the right reel, it will automatically be rewound about two seconds later.
4. The tape will be rewound as far as "999" indication or thereabouts on the tape counter.
5. The tape will now automatically start to play back.

REPEAT END SWITCH

1. Depress the REPEAT END switch to set it to on.
2. The tape now plays back (or records).
3. The tape will be rewound automatically about two seconds after it has been wound onto the right reel.
4. The tape will be rewound to the starting point.
5. The tape will now start to play back automatically.
- The tape will continue to be played back repeatedly until the MEMORY REPEAT OFF switch is depressed.



OPERATING NOTES

- If you set the MEMORY PLAY and the REPEAT COUNTER switches to on and then set the deck to the rewind mode with the tape counter display indicating "999" or less, the deck will be automatically set to the repeat end mode (whereby the tape is played back automatically after it has been wound up) immediately after the tape has been wound up. This does not indicate a failure.

MEMORY SWITCHES

There are two MEMORY switches (MEMORY PLAY and MEMORY STOP). The MEMORY STOP switch serves to rewind a tape during playback or recording as far as the preset "999" indication or thereabout on the tape counter and to stop the tape run. The MEMORY PLAY switch serves to start the tape playback from the "999" indication or thereabouts on the tape counter automatically.

MEMORY STOP SWITCH

1. Depress the MEMORY STOP switch to set it to on.
2. Depress the COUNTER RESET switch at that place on the tape during playback or recording which you want to re-record or re-play again, and set the tape counter to "000."
3. Depress the REW switch once the playback or recording is completed.
4. The tape will be rewound and it will stop at the tape counter indication of "999" or thereabouts.

MEMORY PLAY SWITCH

1. Depress the MEMORY PLAY switch to set it to on.
2. Depress the COUNTER RESET switch at that place on the tape during playback or recording which you want to be played back again later, and set the tape counter to "000."
3. Depress the REW switch once the playback or recording is completed.
4. The tape will be rewound and it will stop at the tape counter indication of "999" or thereabouts.
5. The tape will automatically start playing back.

NOTE:

Always depress the MEMORY REPEAT OFF switch to release the MEMORY PLAY and MEMORY STOP functions.

When you set the deck to the stop mode upon completion of the rewind operation under these circumstances, set the MEMORY/REPEAT switch to off.

- During the repeat counter operation (whereby the tape is automatically set to the repeat playback mode) the portion of the tape with the start of the program will shift slightly forward. This is due to the inertia of the tape itself and is not a failure.

RECORDING

Follow the recording procedure below in numerical order. The step numbers are illustrated in the figure.

Set the switches and controls as follows before you switch the power on.

- Depress the MEMORY REPEAT OFF switch.
- Depress the TIMER START OFF switch.
- Depress the METER-AVERAGE switch.
- Set the INPUT controls to the leftmost position.
- Set the OUTPUT controls to the "6" click position.
- Inspect the head section for dirt. If dirty, clean. (Refer to page 12.)
- Set up the program source (records, FM broadcast, microphone performance, etc.) which you intend to record.

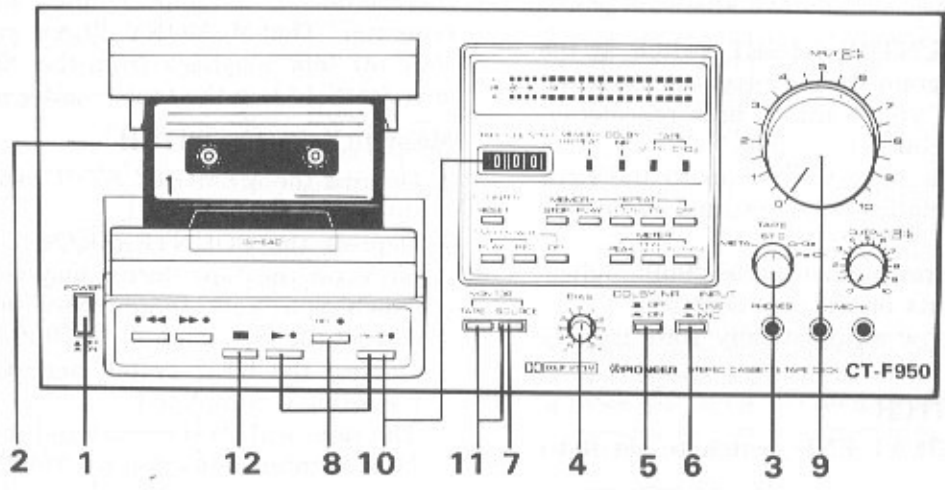

1. Set the POWER switch to ON.

2. Insert the cassette tape.

Check that the tape is on the left reel. Also check that the cassette tape's erasure prevention tabs (refer to page 14) have not been broken off and then insert (refer to page 6).

3. Select the TAPE selector position.

If you have loaded a metal tape into the deck, set this selector to METAL. Set to Fe-Cr for a ferrichrome tape, to STD for a standard tape and to CrO₂ for a chrome tape. For details, refer to the table which is inserted into the operating instructions.

4. Set the BIAS control.

Set the BIAS control to the center (click stop) position or to the setting that corresponds to the tape which you are using. For further details, refer to "ADJUSTING THE BIAS" on page 9.

5. Set the DOLBY NR switch.

Set this switch to ON for recording using the Dolby NR system. (Refer to page 13.)

6. Set the INPUT switch.

Set this switch to LINE if you are recording a program source which is connected to the INPUT terminals. Set it to MIC if you are recording signals from a microphone.

7. Depress the MONITOR SOURCE switch.

8. Stand by for recording.

Depress the PAUSE switch first, and then the ► (PLAY) and REC switches together. Depress the

PAUSE switch, allow the tape to run for about 5 seconds and then depress the PAUSE switch again if you want the leader tape to run free of the heads or if you want to record a blank (no signals) between programs.

9. Set the recording level.

Refer to "Setting the recording level" on page 9 and then set the INPUT controls.

10. Start recording.

First depress the COUNTER RESET switch and set the tape counter to "000."

Then release the PAUSE switch, start the performance of the program source, and start recording.

11. Monitoring the recording

You can monitor the recording level on the level meter or, depress the MONITOR switch TAPE and you will then be able to listen and compare the sound quality with that when the MONITOR switch SOURCE was depressed. If there is anything wrong with the sound when the MONITOR switch TAPE is depressed, it may be due to a deformed tape, dirt in the head section or the recording level or BIAS control and TAPE selector may be set incorrectly. Locate the fault and start recording again.

12. Complete recording.

When the recording is completed, depress the STOP switch and stop the tape. Depress the PAUSE switch to stop the tape temporarily. The auto-stop mechanism will be automatically actuated when the tape is fully wound onto the right reel during recording.

SETTING THE RECORDING LEVEL

If you record a program source at a recording level which is unsuitable, the signal-to-noise ratio of the playback sound will deteriorate and the distortion will increase. Set the level according to the following procedure and safeguard against poor recordings.

1. Depress the **METER-AVERAGE** switch.
 2. Adjust the **INPUT** recording level controls so that the meter display is contained within a -3dB to 0dB (This indication is 0 to $+3\text{dB}$ with metal tapes.) range when the program source has relatively high signal strengths.
 3. Now depress the **METER-PEAK** or **PEAK HOLD** switch.
 4. Re-adjust the **INPUT** recording level controls so that the meter display does not continuously exceed $+5\text{dB}$.
 5. Depress the **METER-AVERAGE** switch and check that the meter indication is less than 0dB . (This indication is $+3\text{dB}$ with metal tapes.).
- If you record a sound source when the meter indication exceeds full scale, the playback sound will be distorted. Conversely, if the meter indication is too low (-20dB to -10dB), the signal-to-noise ratio will deteriorate and you will hear a great deal of noise when you play your recording back.
 - If you adjust the recording level merely on the basis of the peak signal indication, the recording level will be set too low since you have adjusted it with the maximum input signal value. As a result, the signal-to-noise ratio will be downgraded.
 - The signal level will fluctuate widely according to the program source, and so keep observing the meter indication while you are recording.

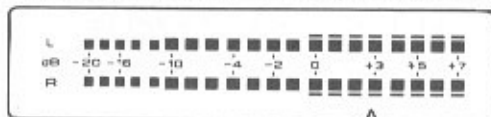

- The $+3$ mark indicates Dolby NR level.
- This position is the extent of the allowable range for the input level when you use a metal tape.

PEAK METER AND LEVEL METER

The peak meter can cope more sensitively with sudden peak inputs than the level meter can. The level meter serves almost to simulate your sense of hearing, and it indicates the average strength of the input signals. Naturally, the peak input signal which is recorded has a higher level than the average level and so the standard '0dB' level meter level is set lower than the saturation level of the tape.

The peak meter is constructed so that its very fast response speed indicates peaks even if pulse-like signals are included in the input signals. When performing live recordings or when recording sources with a great many peak portions, make use of the peak meter and you will then ensure that the sound will not be distorted at the peak level. The peak hold meter not only functions as a peak meter but it also holds the peak level to display it.

ADJUSTING THE BIAS

Your recordings will display the maximum sound quality with the minimum distortion if you select a bias which agrees with the characteristics of the tape you are using.

The center (click stop) position of the CT-F950's **BIAS** control is for the standard bias but you can also adjust the bias optimally in accordance with the tape being used.

1. Follow steps 1 to 9 in the recording procedure and set the cassette deck to the recording standby mode.
2. Depress the **MONITOR** switch **TAPE**.
3. Depress the **PAUSE** switch, then allow the tape to run and record the program source.
4. Monitor the playback sound through the speakers or headphones and at the same time set the **BIAS** control to the optimum position in accordance with the characteristics of the tape.
5. Depress the **MONITOR SOURCE** switch and rewind the tape as far as the point on the tape from which you want to start the recording.

NOTE:

Adjust the bias after you have mastered the recording procedure.



The optimum **BIAS** control position of leading brands of tape is listed in the accessory table.

SETTING THE TAPE SELECTOR

At the same time as you select the bias in accordance with the tape you are using, it is necessary to compensate for the high-end of the frequency range. Set the **TAPE** selector in accordance with the type of tape you are using. Recommended positions of the **TAPE** selector is listed on the table which is inserted into the operating instructions.

FOLLOW-ON RECORDING

You can record a new program source onto a pre-recorded tape which is playing in the deck if you depress the ► (PLAY) and REC switches together. This procedure is particularly effective for tape editing.

USING THE MONITOR SWITCHES

The CT-F950 adopts an independently aligned erase/recording/playback 3-head system. If you depress the MONITOR switch TAPE during recording, you can listen to the program which you have just recorded. If you depress the MONITOR switch SOURCE, you can listen in to the program which you are about to record. This means that by selecting the switches you can monitor the recording through your headphones. Set the stereo receiver's TAPE MONITOR switch to ON when monitoring a recording from a stereo receiver connected to the CT-F950.

ERASING RECORDED SOUND

- To completely erase a program which you have already recorded, turn the recording level (INPUT) controls to their leftmost position, and run the tape with the deck set to the recording mode.
- When recording a new program over a pre-recorded tape, the previous sound will be automatically erased and the new program will be recorded over it.

MICROPHONE RECORDING

STEREO RECORDING

As shown in under figure, use a stereo microphone or two identical microphones and connect the one for the left channel to the MIC L jack and the one for the right channel to the R MIC jack. For the actual recording, refer to "RECORDING" on page 8.

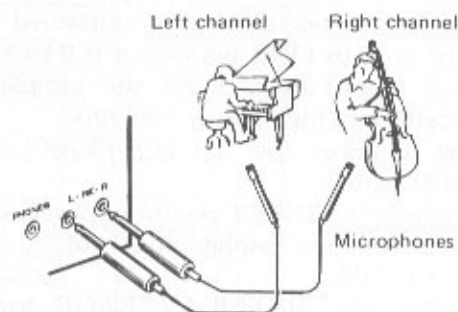

Points to bear in mind

- Use dynamic or electret microphones.
- Make sure that the connecting cord for a high-impedance microphone is less than 5 meters long.
- You will not have to worry about howl if you use your headphones to check the state of the recording.
- Monitoring the recording with the speakers very often gives rise to howl so use the microphones as far away as possible from the speakers. There will be no howl, however, with headphones.
- You may damage the microphone if you plug it into the HEADPHONES jack by mistake.

PLAYBACK

Follow the playback procedure below in numerical order. The step numbers are illustrated in the figure.

Set the switches and controls as follows before you switch the power on.

- Depress the MEMORY REPEAT OFF switch.
- Depress the TIMER START OFF switch.
- Depress the METER-AVERAGE switch.
- Depress the MONITOR TAPE switch.
- Set the OUTPUT controls to the "6" click position.
- Check that the head section is not dirty. If dirty, clean it.
- Set the stereo receiver's power switch and the TAPE MONITOR switch to ON to enable tape playback.

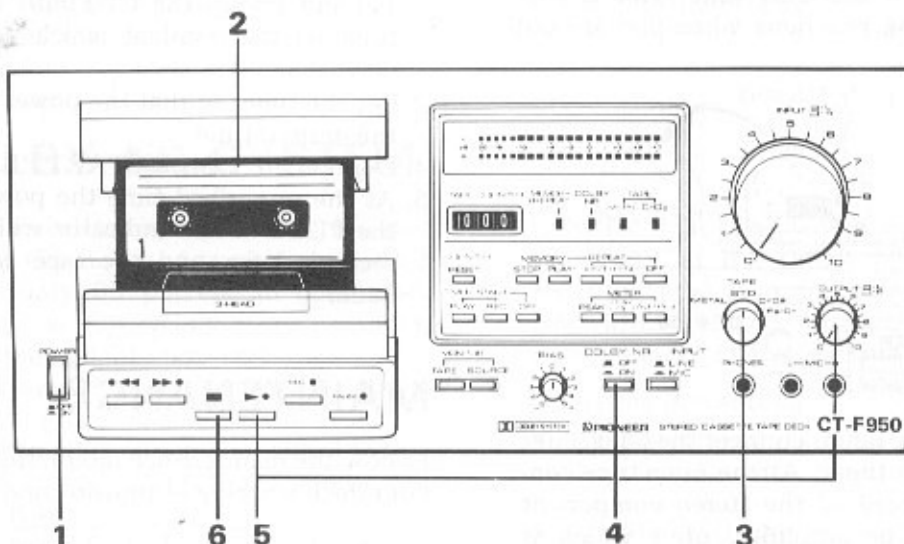

1. Set the POWER switch to ON.

2. Insert a cassette tape.

Check that the tape is on the left reel and then insert (Refer to page 6).

3. Select the TAPE selector position.

If you have loaded a metal tape into the deck, set this selector to METAL. Set to Fe-Cr for a ferrichrome tape, to STD for a standard tape and to CrO₂ for a chrome tape. For details, refer to the table which is inserted into the operating instructions.

4. Set the DOLBY NR switch.

Set this switch to ON when playing back a tape, which was recorded by the Dolby NR system. For further details on the Dolby NR system, refer to page 13.

5. Start playback.

Depress the PLAY switch and the tape will start to run. Adjust the volume to the preferred level by rotating the OUTPUT control on the CT-F950, and the volume control on the stereo receiver.

6. Complete playback.

The tape will stop when it has been wound onto the right reel, and the PLAY indicator will go off.

Depress the STOP switch when you want to stop the tape run during playback. Depress the PAUSE switch for a temporary stop.

NOTE:

The CT-F950 can be set up for automatic repeat tape playback. Refer to "REPEAT PLAYBACK FUNCTION" on page 7 for details.

OUTPUT (PLAYBACK LEVEL) CONTROLS

These controls are used to adjust the output signal level when a tape is being played back and also the volume level of headphones. Turning the controls to the right increases the level. The controls are coupled when turned but it is also possible to adjust the right channel (back) and the left channel (front) independently.

Since these controls are coupled to the level meter, it is possible to adjust the indication of the meter so that it corresponds with the recording level—whether high or low—when the pre-recorded tape is played back.

When these controls are set to their click-stop positions and a tape is played back, the regular playback level is indicated by a meter display of 0dB. This function allows you to check the difference in sensitivity between your various tapes and also to check the signal level especially when playing back or recording a tape with the Dolby NR switch at ON.

OPERATIONS WITH THE TIMER

UNATTENDED RECORDING

If you use an optional timer, you will be able to automatically record an FM broadcast or other program source at a specified time. This is convenient for recording programs when you are out or asleep.

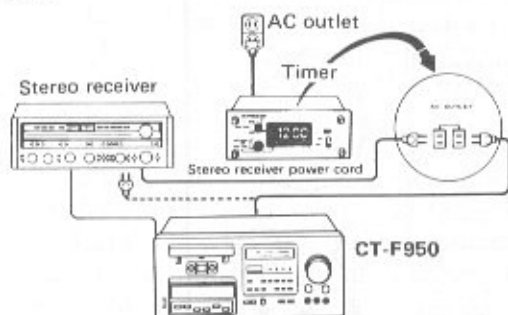

1. As shown in above figure, connect the CT-F950's power cord to the timer. At the same time connect the power cord of the stereo component (receiver, tuner, or amplifier, etc.) which is connected to the CT-F950 so that the power ON/OFF functions of that component are controlled by the timer.
 2. Set the power switches of the CT-F950 and stereo component to ON, and select the broadcasting station whose program you want to record.
 3. Follow steps 1 to 9 in the section on "RECORDING" on page 8 and set the recording level. Rewind the tape back to the point at which you want to start recording.
 4. Set the timer so that the power will come on at the prescribed time. The power to the other stereo components goes off.
 5. Depress the TIMER START REC switch.
 6. At the prescribed time the power will automatically go on, and the REC and PLAY switch indicators will light up about three seconds later. Recording will then commence. When the tape is completely wound onto the reel, the auto-stop mechanism is actuated and the tape is stopped. Next, the timer operates and switches the power to the CT-F950 and the stereo component off.
- Turn the receiver's volume control right down so that the sound is not heard through the speakers while you are out.
 - For more details on the connections, refer to the timer's instructions booklet.
 - Set the time on the timer so that the power to the CT-F950 and stereo component goes off after the tape is fully wound onto the right reel.

WAKE-UP PLAYBACK

You can have the CT-F950 play back a pre-recorded tape automatically at a desired time. You can set the timer so that the tape's music wakes you up instead of an alarm clock.

1. As shown in left figure, connect the CT-F950.
2. Follows steps 1 to 5 in "PLAYBACK" on page 11, and set up the CT-F950. Rewind the tape back to the point at which you want to start playback.
3. Set the timer so that the power is switched on at the desired time.
4. Depress the TIMER START PLAY switch.
5. At the prescribed time the power will come on, the PLAY switch indicator will light up about 3 seconds later, and the tape will start to play back.

MAINTENANCE

Follow the maintenance instructions below to keep your deck working in tip-top condition.

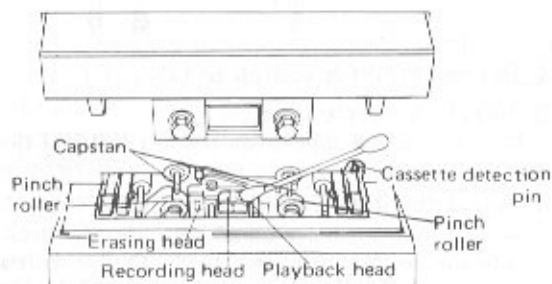

CLEANING THE HEAD SECTION

As shown in above figure that the head section is composed of the heads, capstan and pinch rollers, and with extended use these parts accumulate dust, dirt and grease easily as the tape runs.

If this assembly gets dirty, the contact between the tape and the surface of the heads is impaired and this downgrades the sound quality and stereo balance, and it also leads to unstable operation. To prevent this, clean the head section and the surrounding parts regularly with the accessory cleaning swabs or with a soft cloth dipped in the cleaning fluid.

You will find that it is easier to clean the pinch roller if you depress the cassette detection pin and the PLAY switch, since this operation will cause the pinch roller to rotate.

NOTE:

When the cassette detection pin is depressed, the tape slack take-up mechanism will be actuated. This does not indicate a failure so continue to clean the pinch roller.

DEMAGNETIZING THE HEADS

The recording head becomes magnetized when you use the tape deck for prolonged periods of time. This results in noise being generated and the treble dropping off during recording and playback. The recording head should therefore be regularly demagnetized with the head eraser, which is sold separately. For further details, refer to the head eraser's instructions booklet.

CLEANING THE FRONT PANEL, DUST COVER

Use a soft cloth to wipe off dust and grease from the front panel and dust cover. When these parts are very dirty, dip the soft cloth in a small amount of neutral cleanser, remove the dirt and wipe dry with a dry cloth. Never use volatile sprits like thinners, benzine or alcohol because they will damage the panel's finish.

THE DOLBY NR SYSTEM

A cassette tape travels at one quarter of the speed of an open-reel (19cm/sec, 4-track) tape, and its track width is only 60 percent in comparison. The cassette tape is thus clearly at a disadvantage with respect to the signal-to-noise ratio.

The Dolby NR system is designed to reduce the noise called hiss which is inherent in tapes, and it is effective in upgrading the signal-to-noise ratio. It is so effective, in fact, that it is now indispensable to cassette decks.

The basic principle of the Dolby NR system is as follows: when signals with a relatively low level are recorded, the Dolby NR circuitry enhances the signals in the high-frequency range which has most of the hiss components, and these signals are then recorded. When they are played back, the circuitry attenuates only those components which were enhanced during recording. This returns the signal components to the normal level, and the hiss is reduced (by a maximum of 10dB) during playback

only for that level which was attenuated. In the same way, if the Dolby NR system is used for recording, the recording level can be set relatively low which enables almost distortion-free good sound quality tape recordings.

Operating precautions

- The adjustment of the recording level is basically the same as when the Dolby NR system is not used.
- In order to make the most of the effect of the Dolby system, choose a program source with as little noise as possible.
- If you have used the Dolby NR system to record a program, make sure that you use it when playing the same program back.
- Playing back a normally recorded tape with the Dolby NR system and playing back normally a tape which was recorded by the Dolby NR system will result in an unnatural reproduction of the sound on the tape.

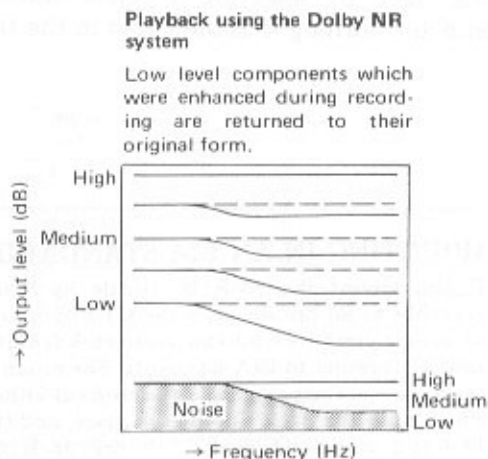
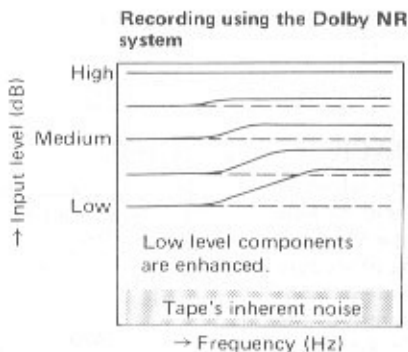
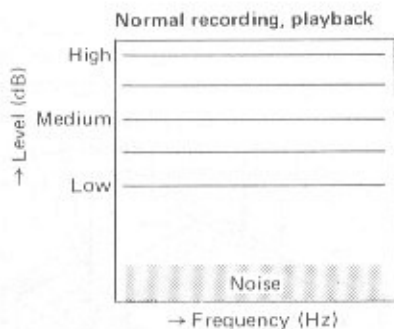

CASSETTE TAPES

Cassette tapes are manufactured according to international standards governing their construction, and they are generally classified according to their tape performance and recording time.

Performance classifications

Standard type ^a	Low-noise type	High-performance type
<ul style="list-style-type: none"> • Standard tape • Dynamic tape 	<ul style="list-style-type: none"> • Low-noise tape • Low-noise, high-output tape 	<ul style="list-style-type: none"> • Chrome tape • Ferrichrome tape • Metal tape

Recording time classifications

Cassette tape designation	Recording time (minutes)	
	One side	Both sides
C-30	15	30
C-46	23	46
C-60	30	60
C-90	45	90
C-120	60	120

The size of the cassette tapes is the same but their playing (and recording) times differ according to the tape thickness (length).

The C-60 and C-90 tapes are most commonly used. The C-120 tapes are not recommended because their mechanical and electrical specifications vary.

CHECK CASSETTE BEFORE USE

Slack or protruding tapes

If the tape protrudes from the cassette as shown in right above figure or is slack, the tape may run without passing through between the capstan and the pinch roller and so may be damaged. Take up the slack by inserting a pencil through the reel hub and turning it as indicated in the figure.

Some tapes provide a tape stopper to prevent tape slack. Make sure that you remove the tape stopper before inserting the tape into the deck.

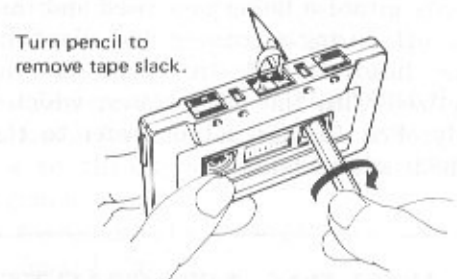

Erasure prevention tabs

Cassette tapes are provided with erasure prevention tabs, as shown below, which act as a protection device to prevent the accidental erasure of a recording which you want to keep. If you remove the tabs, as shown below, with a screwdriver you will be able to prevent erasure if you accidentally set the CT-F950 to the recording mode by depressing the REC switch.

To re-record, cover the tab opening with a double layer of adhesive tape.

NOTE:

Cassette tapes are provided with two tabs (A or 1 and B or 2) so you can protect the recordings on both sides.

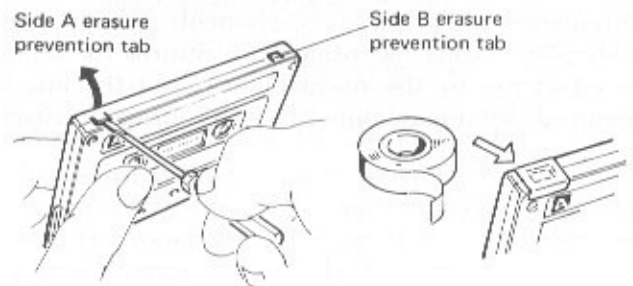

MOUNTING IN AN EIA STANDARD RACK

If you mount the JA-R102 (made by Pioneer) which is available as an option onto the CT-F950, you will be able to mount your deck into an audio rack featuring a 4U pitch and conforming to EIA standards. The mounting procedure is simple: just remove the two screws at either side in front which hold the deck's bonnet in place, and then mount the JA-R102 onto the deck with the JA-R102's accessory screws. For further details, refer to the JA-R102's instructions booklet.

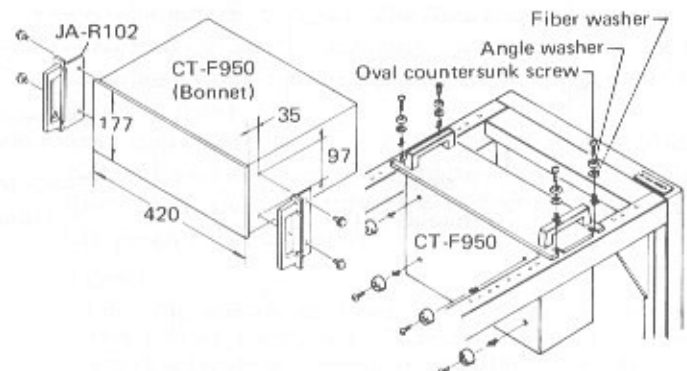

SPECIFICATIONS

- Systems Compact cassette, 2-channel stereo
- Motors Capstan drive; DC servo motor x 1
Reel drive; DC high torque motor x 1
- Heads Ferrite recording/
playback combination type head x 1
erasing head x 1
- Fast Winding Time Approximately 85 seconds
(C-60 tape)
- Wow and Flutter No more than 0.04% (WRMS)
- Frequency Response
-20dB Recording
Standard, LH tapes 20 to 17,000Hz
(25 to 15,000Hz ± 3dB)
Ferrichrome tape 20 to 19,000Hz
(25 to 17,000Hz ± 3dB)
Chromium dioxide tape 20 to 19,000Hz
(25 to 17,000Hz ± 3dB)
Metal tape 20 to 19,000Hz
(25 to 18,000Hz ± 3dB)
- 0dB Recording
Chromium dioxide tape 20 to 11,000Hz
Metal tape 20 to 14,000Hz
- Signal-to-Noise Ratio . . . Dolby NR OFF; More than 59dB
Dolby NR ON; More than 69dB
(over 5kHz)
- Harmonic Distortion No more than 1.2% (0dB)
- Inputs (Sensitivity/Maximum allowable input/Impedance)
MIC (L, R); 0.3mV/100mV/30kilohms, 6mm diam.
jack (Reference MIC impedance; 250 ohms to 30 kilohms)
LINE x 2; (60mV/25V/100 kilohms) Pin jack
- Outputs (Reference level/Maximum level/Load impedance)
LINE x 2; (450mV/640mV/50 kilohms) Pin jack
HEADPHONES x 1; 63mV/90mV/8 ohms, 6mm diam.
jack
- Semiconductors Transistors x 76
Diodes x 84, Photo interrupter x 1
- Subfunctions ICs x 13
 - Dolby NR system (ON-OFF) with LED indicator lamp
 - Fluorescence tube level meter (-20 to +7dB)
{Peak/Peakhold/average selector}
 - Fluorescence tape counter
 - Bias fine adjusting control knob
 - Memory stop/Memory play
 - Counter repeat/End repeat
 - Input selector
 - Automatic tape slack canceller
 - Cassette compartment illumination
 - Standby mechanism with unattended recording
 - Tape Selector 4 position.
 - Click Stop. Output VR.

- Power Requirements AC 120V 60Hz
- Power Consumption 54 watts
- Dimensions 420(W) x 187(H) x 368.5(D)mm Max.
16-9/16 x 7-3/8 x 14-1/2 in.
- Weight 10.1kg (22lb 4oz.)
- Furnished parts Stereo connecting cords with
pin plugs x 2
Head cleaning swabs x 3
Operating instructions x 1

NOTE:

Specifications and the design subject to possible modification without notice due to improvements.

NOTES:

1. Reference Tapes: Standard & LH: DIN 45513/BLATT6 or equiv.
: CrO₂: DIN 45513/BLATT7(CrO₂) or equiv.
2. Reference Recording Level: Meter 0dB indicating level (160 nwb/m magnetic level = Philips cassette reference level)
3. Reference Signal: 333Hz
4. Wow & Flutter: • JIS [3kHz, with acoustic compensation (weighted), rms value]
5. Frequency Response: • Measured at -20dB level, DOLBY NR OFF, level deviation is ±6dB without indication.
6. Signal to Noise Ratio: • Measured at the third harmonic distortion 3% level, weighted.
7. Sensitivity: Input level (mV) required for reference recording level with input (REC) controls set to maximum.
8. Maximum Allowable Input: While decreasing settings of input (REC) level controls and increasing level at input jacks, this is the maximum input level (mV) at the point where recording amplifier output waveform becomes clipped.
9. Reference Output Level: Playback output level when meter indicates 0dB.
10. Maximum Output Level: Playback output level with respect to reference recording level when output (PLAY) level controls are set to maximum.

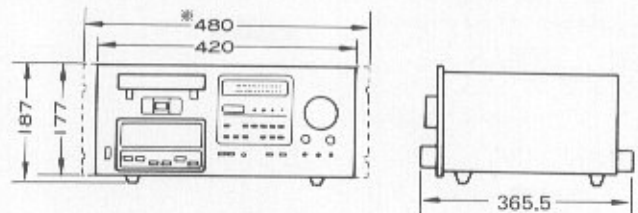

420(W) x 187(H) x 365.5(D)mm Max.

* with rackmount adaptor JA-R102

* 480(W) x 187(H) x 380(D) mm Max.

Unit: mm

TROUBLESHOOTING

Although some failures and breakdowns can be traced to legitimate mechanical faults, some are in fact the results of improper maintenance, tape defects or lack of experience in operating the tape deck. If you think that there is a failure, refer first to the following checklist.

Symptom	Cause	Remedy
Tape does not run.	<ol style="list-style-type: none"> 1. AC cord is not plugged in. 2. Tape has run out. 3. PAUSE switch is set to ON. 4. Cassette is inserted improperly. 	<ol style="list-style-type: none"> 1. Plug cord correctly. 2. Rewind tape. 3. Depress PAUSE switch to OFF. 4. Remove tape and insert properly.
High frequencies are weak.	<ol style="list-style-type: none"> 1. Heads are dirty. 2. BIAS control and TAPE selector are not set in accordance with tape during recording or playback. 3. A recorded tape without using the Dolby NR system is being played back with DOLBY NR switch set to ON. 	<ol style="list-style-type: none"> 1. Clean heads. 2. Set BIAS control and TAPE selector correctly in accordance with tape. 3. Depress DOLBY NR switch to OFF.
No playback sound.	<ol style="list-style-type: none"> 1. OUTPUT controls are set to leftmost positions. 2. MONITOR switch is set to SOURCE. 	<ol style="list-style-type: none"> 1. Turn controls to suitable position. 2. Depress MONITOR switch to TAPE.
Playback sound is distorted.	<ol style="list-style-type: none"> 1. Playback level is too high. 2. Distortion is recorded on tape. 	<ol style="list-style-type: none"> 1. Reduce playback level. 2. Replace cassette tape.
Sound is unsteady.	<ol style="list-style-type: none"> 1. Dirty capstan. 2. Irregular cassette tape winding. 	<ol style="list-style-type: none"> 1. Clean capstan. 2. Replace tape.
Excessive noise.	<ol style="list-style-type: none"> 1. Tape is old. 2. Recorded tape using the Dolby NR system is being played back with DOLBY NR switch set to OFF. 	<ol style="list-style-type: none"> 1. Replace tape. 2. Depress DOLBY NR switch to ON.
Cannot record.	Cassette's erasure prevention tabs have been broken off.	Replace tape or cover tab openings with adhesive tape.
Recorded sound is distorted.	<ol style="list-style-type: none"> 1. Input level is too high. 2. Dirty heads. 	<ol style="list-style-type: none"> 1. Reduce input level. 2. Clean heads.
Auto-stop mechanism is actuated before tape wound up.	MEMORY/REPEAT STOP switch is set to ON.	Depress MEMORY/REPEAT OFF switch to release.
Auto-stop mechanism does not act even if tape wound up.	MEMORY/REPEAT STOP or PLAY switch is set to ON.	Depress MEMORY/REPEAT OFF switch to release.

PIONEER ELECTRONIC CORPORATION

4-1, Meguro 1-Chome, Meguro-ku, Tokyo 153, Japan

U.S. PIONEER ELECTRONICS CORPORATION

85 Oxford Drive, Moonachie, New Jersey 07074, U.S.A.

PIONEER ELECTRONIC (EUROPE) N.V.

Luithagen-Haven 9, 2030 Antwerp, Belgium

PIONEER ELECTRONICS AUSTRALIA PTY. LTD.

178-184 Boundary Road, Braeside, Victoria 3185, Australia

Printed in Japan