

McIntosh

MULTIPATH/ TUNING INDICATOR

MI-2

TABLE OF CONTENTS

| | |
|---|----|
| GENERAL DESCRIPTION | 1 |
| TECHNICAL DESCRIPTION | 3 |
| Specifications | 3 |
| FRONT PANEL INFORMATION | 4 |
| BACK PANEL INFORMATION | 5 |
| INSTALLATION | 6 |
| CONNECTING | 8 |
| Connecting to McIntosh MR67 Tuner | 8 |
| Connecting to McIntosh MX110 Tuner-Pre-amplifier with Z or X Serial Numbers | 8 |
| Connecting to McIntosh MX110 Tuner-Pre-amplifier with M Serial Numbers | 10 |
| Connecting to McIntosh MR65B Tuner | 10 |
| Connecting to McIntosh MR65 and MR65A Tuner | 10 |
| Connecting to McIntosh MR66 Tuner | 10 |
| Connecting to McIntosh MR55A Tuner | 10 |
| Connecting to McIntosh MR55 Tuner | 10 |
| Connecting to All Other Tuners | 11 |
| OPERATING INSTRUCTIONS | 12 |
| GUARANTEE | 16 |
| 3-YEAR FACTORY SERVICE CONTRACT | 16 |



OWNER'S MANUAL

MI-2 MULTIPATH/TUNING INDICATOR

GENERAL DESCRIPTION

The McIntosh MI-2 Multipath/Tuning Indicator is designed to be used with an FM tuner to detect and display multipath reception. Multipath reception is the result of a reflected signal arriving at the tuner antenna slightly later than the direct signal. By rotating or repositioning your FM antenna it is possible to reduce the multipath reception. The MI-2 Multipath/Tuning Indicator makes it easy to know when the FM antenna is oriented for the best reception of any station.

Multipath reception degrades FM tuner performance in several ways:

- 1) Usually there is an increase in background noise level.
- 2) Distortion is often heard in the program signal.
- 3) Stereo separation may be reduced.
- 4) The stereo effect may be completely lost.
- 5) Stereo indicators may fail to function, or function erratically.

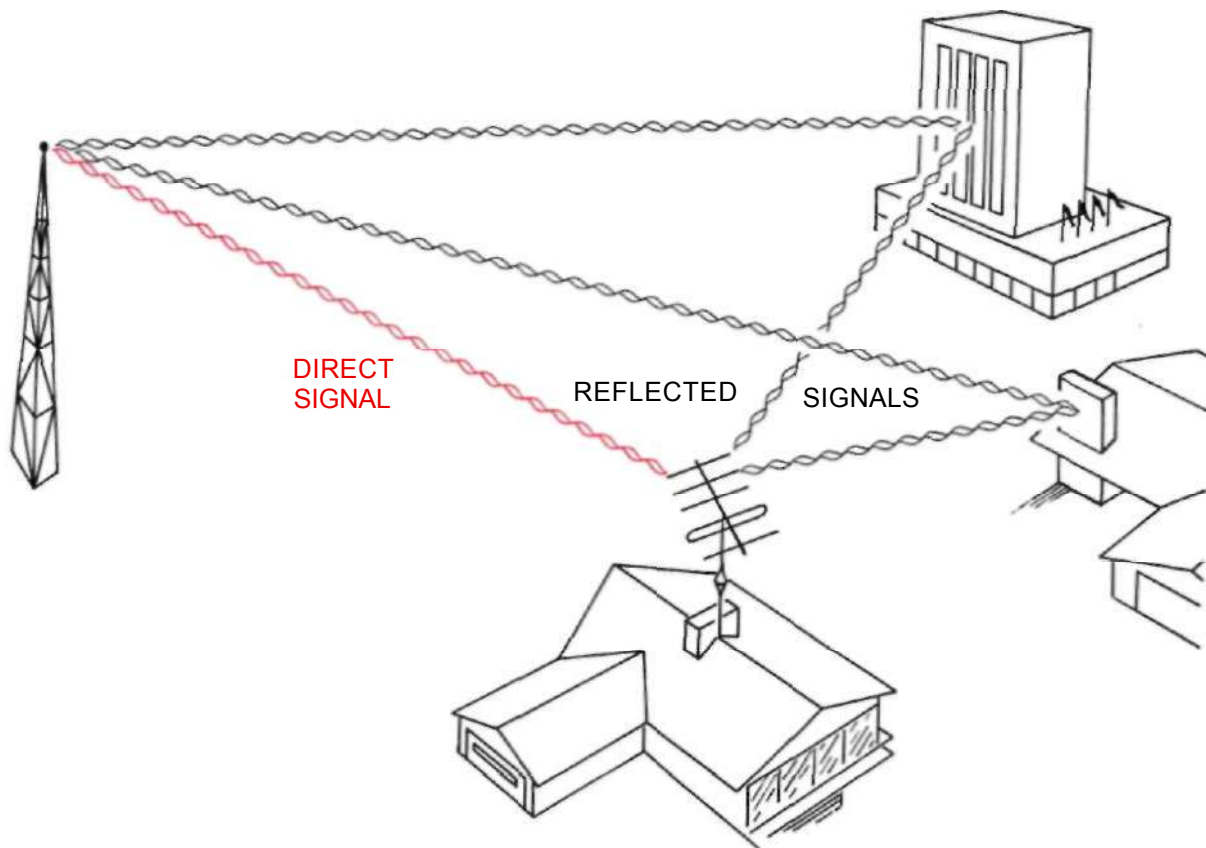
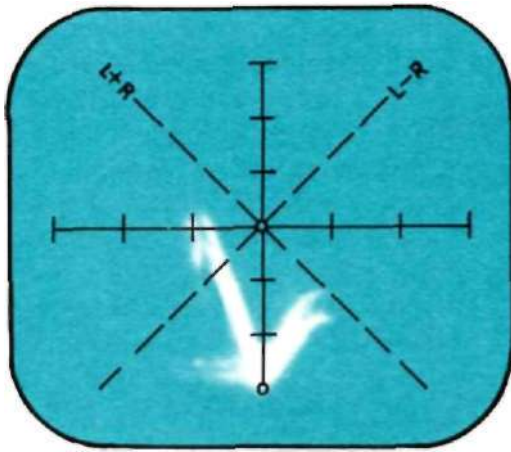

Figure 1. FM Tuner Antenna Receiving Direct and Reflected Signals

To show multipath reception the MI-2 displays instantaneous signal strength versus frequency deviation. Signal strength is shown as vertical deflection of the indicator display beam. Frequency deviation is shown as horizontal deflection. Multipath reception appears as a peak or a valley in the MI-2 display. See Figure 2.

To overcome multipath reception it is usually necessary to orient the tuner antenna to receive the FM signal by only one predominant path. Rotating a directional antenna is very effective at correcting multipath reception. In a metropolitan area where a simple antenna such as a dipole is used repositioning the antenna will achieve the same result.



(2a)

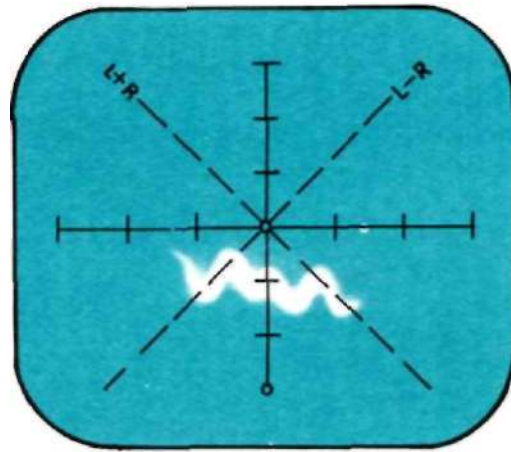

(2b)

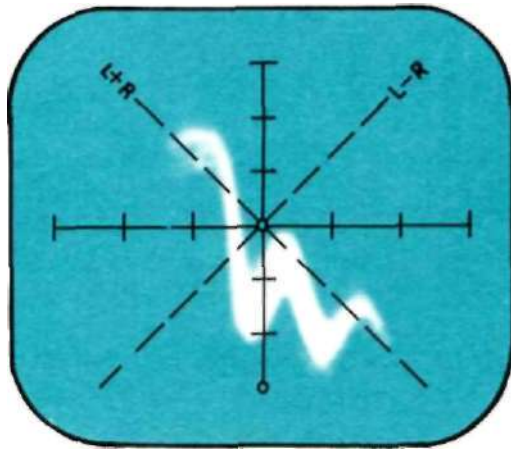

(2c)

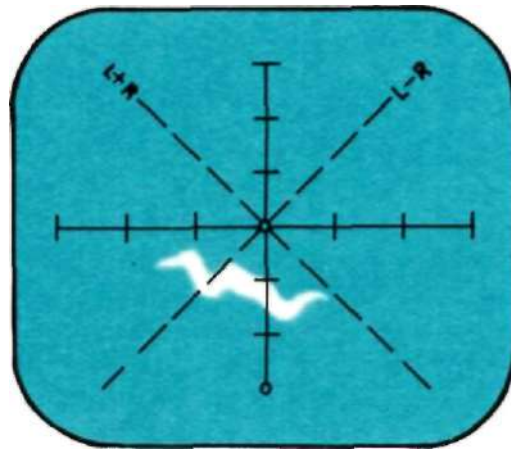

(2d)

Figure 2. Various Forms of Multipath Reception
As They Appear on the MI-2 Display Screen.

Such a change may be as little as a fraction of a foot or as much as several feet.

The MI-2 is also a very effective tuning indicator:

- 1) Signal strength is shown by the vertical position of the display trace. The higher the position of the trace the greater is the signal strength.
- 2) Correct tuning occurs when the display trace is centered horizontally on the screen. Since the display trace effectively follows the tuner I.F. response curve, centering the trace tunes the detector to the center of the I.F. curve.

The McIntosh MI-2 Multipath/Tuning Indicator is a versatile instrument. Its usefulness has been extended to show other signal voltages. By turning the SCOPE TEST switch to the L & R AUDIO position the MI-2 shows the stereo or monaural character of the audio signals).

- 1) A trace display along the L+R line will occur with a monaural program source.
- 2) A trace display along the L-R line will occur with a monaural program source if the phase of one channel is reversed.
- 3) A vertical trace indicates that the program is being delivered to the left channel only.
- 4) A horizontal trace indicates that the program is being delivered to the right channel only.
- 5) Operating the balance control on your tuner-preamplifier or system preamplifier can change the slope angle of the L+R or L-R display.
- 6) A stereo program will be a complex and varying circular or elliptical display of irregular outline that depends on channel separation or on the phase amplitude relation of the Left and Right channel.

TECHNICAL DESCRIPTION

The MI-2 Multipath/Tuning Indicator is essentially an oscilloscope using a three inch cathode-ray tube. Adequate brightness is assured by using a 1350 volt accelerating voltage. To provide a sharp and well defined trace, the MI-2 uses separate focus and astigmatism controls.

Two identical direct coupled push-pull amplifiers are used in the horizontal and vertical deflection circuits. Phase shift in each amplifier is held to within a few degrees from D.C. throughout the operating frequency range. Phase differences between vertical and horizontal amplifiers are also held to within a few degrees.

The high-voltage power supply uses a 6W4 tube rectifier. Two low-voltage supplies use selenium rectifiers, two gas filled regulator tubes and an electronic voltage regulator. The operating voltages from these supplies are carefully regulated over a wide range of power line variations. This design feature assures a steady indicator trace despite changing line voltage.

For Multipath display the horizontal deflection voltage is obtained from the tuner discriminator output ahead of the de-emphasis network. This voltage is proportional to the frequency deviation of the FM transmission. The maximum width of the indicator screen is designed to correspond to approximately plus and minus 75 kilocycle deviation of the FM transmitter.

The horizontal multipath input is connected through the Deviation Input jack and

the Deviation (horizontal) calibration control.

For multipath display the vertical deflection voltage is obtained from the tuner Automatic Gain Control circuit at the input to the first limiter. This voltage is proportional to FM station's instantaneous signal strength. However the average proportionality is exponential. Because of the exponential characteristic, a weak station will produce adequate vertical deflection. A powerful local station should position the center of the indicator trace about half to three quarters of an inch below the top of the vertical scale.

The vertical Multipath Input is connected through the Signal Strength Input and the Signal Strength (vertical) Calibration Input Control.

For L & R Audio display the horizontal deflection voltage is obtained from the right channel output of a tuner, a preamplifier or even a power amplifier. This deflection voltage is connected through the Right Audio Input and the Right Gain Control.

For L & R Audio display the vertical deflection voltage is obtained from the left channel output of a tuner, a preamplifier or a power amplifier. This deflection voltage is connected through the Left Audio Input and the Left Gain Control.

With a normal loudness monaural signal both audio input controls are adjusted for equal deflection of the display trace. At this point the trace will lie on the L+R line if the two signals are in phase or the L-R line if they are 180° out of phase.

MI-2 SPECIFICATIONS

Sensitivity

| | |
|----------------------------------|--------------------|
| Signal Strength (Vertical) Input | 0.37 Volts per Cm. |
| Left Gain (Vertical) Input | 0.37 Volts per Cm. |
| Deviation (Horizontal) Input | 0.27 Volts per Cm. |
| Right Gain (Horizontal) Input | 0.27 Volts per Cm. |

Dimensions

Front panel 15⁵/₈ inches x 5¹/₈ inches; overall depth of chassis behind front panel, 11¹/₂ inches; clearance in front of mounting panel including knobs, 1 inch.

Tube and Semiconductor Complement

| |
|--|
| 1—3RP1, 3 inch Cathode Ray tube. |
| 4—6U8, Horizontal and Vertical Deflection amplifiers |
| 1—6U8, Electronic Voltage Regulator. |
| 1-6W4, High Voltage Rectifier. |
| 2-OB2, Voltage Regulators. |
| 6—Selenium Rectifiers, low-voltage supply. |

Weight

Chassis only, 22 pounds.
In shipping carton, 29 pounds.

Finish

Anodized gold and black glass front panel.

Power Consumption

50 watts, 105 to 125 volts.
50 to 60 cycles.

Fuse

1 Ampere SLO BLO

FRONT PANEL INFORMATION

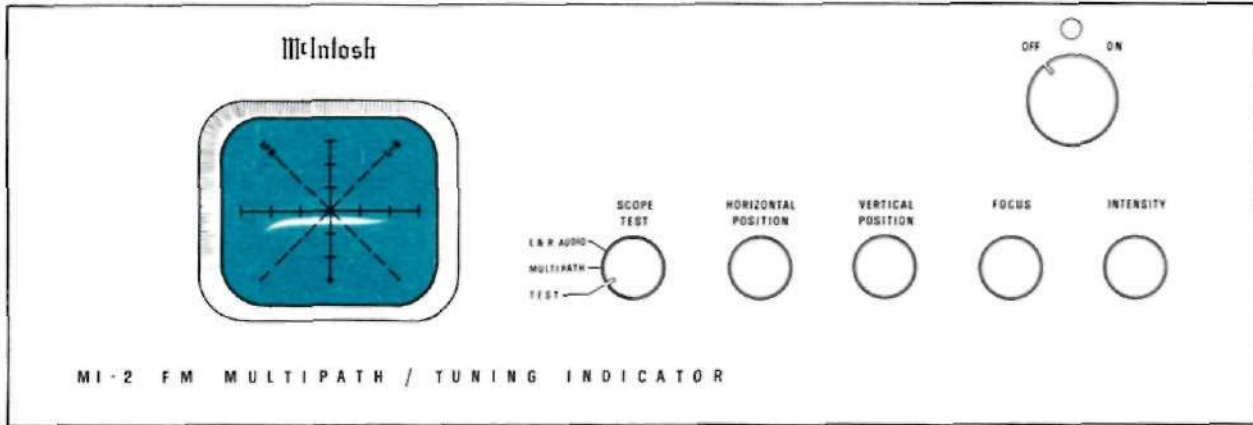

Figure 3. MI-2 FM MULTIPATH/TUNING INDICATOR Front Panel.

INDICATOR SCREEN

The screen is the face of a cathode ray tube. Calibration marks are provided to allow correct positioning of the indicator trace.

A correctly tuned station free of multipath distortion will appear as a smooth curve centered on the indicator screen vertical scale. The vertical line is marked to show the relative strength of the FM signal. A strong local signal should position the display about 1/2 to 3/4 inch from the top of the vertical scale. The horizontal line is marked to show deviation.

The two 45° sloped lines show L + R and L - R information.

SCOPE TEST

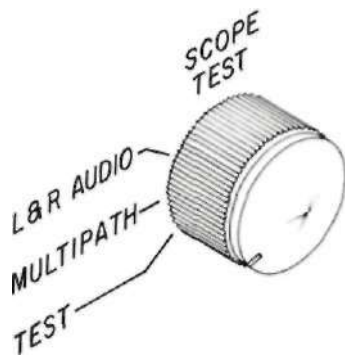

Figure 4. SCOPE TEST Control.

This control switches the indicator circuits to show Multipath, Left and Right audio signals or Test. The TEST position switches the indicator trace to a single dot for adjustment of trace position, focus and intensity. Different trace reference positions are necessary for multipath and L & R Audio.

HORIZONTAL POSITION



Figure 5. HORIZONTAL POSITION Control.

This control moves the indicator trace to the left or right. With the Scope Test switch in TEST position, the trace dot can easily be centered on the indicator screen.

VERTICAL POSITION

This control moves the indicator trace up or down. With the Scope Test switch in TEST

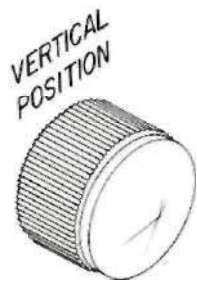

Figure 6. VERTICAL POSITION Control.

position the indicator trace can be easily moved to the correct vertical position. For Multipath display the trace is positioned at the bottom reference point (point A). For audio indications the trace is positioned at the center reference point (point B). This shift in position occurs automatically as the Scope Test Control is turned. An internal adjustment labeled "L & R position" is factory preset but can be readjusted if needed.

INTENSITY



Figure 7. INTENSITY Control.

This control adjusts the brightness of the indicator trace. After the Intensity control has been turned, the Focus control may have to be readjusted for the best possible indicator trace.

FOCUS



Figure 8. FOCUS Control

This control adjusts the sharpness and clarity of the indicator trace. Focus is easiest with the Scope Test switch in TEST position.

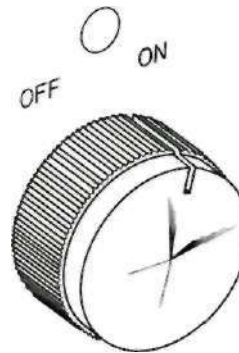

Figure 9. ON-OFF SWITCH PILOT LIGHT

BACK PANEL INFORMATION

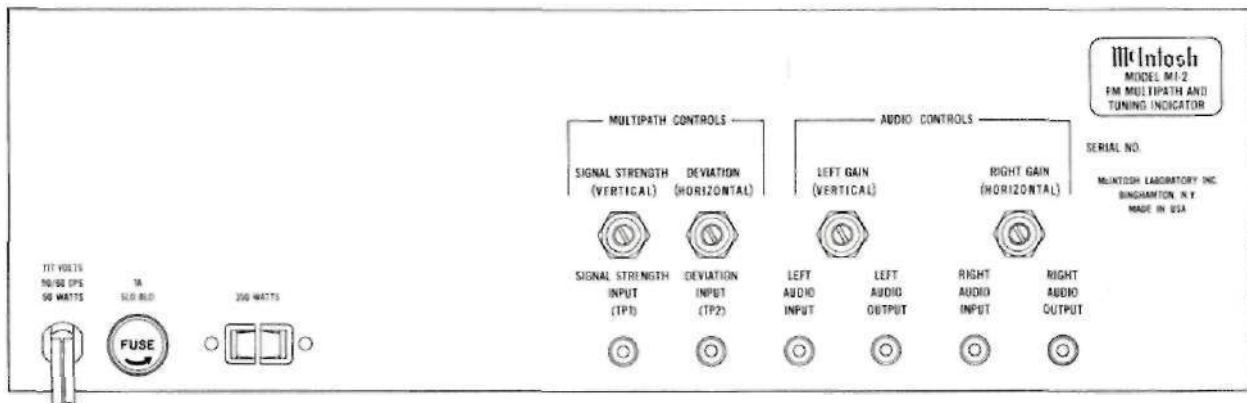

Figure 10. MI-2 FM MULTIPATH/TUNING INDICATOR Back Panel.

SIGNAL STRENGTH (VERTICAL) MULTIPATH CONTROL

This Control adjusts the position of the Multipath trace display along the vertical scale of the indicator screen.

DEVIATION (HORIZONTAL) MULTIPATH CONTROL

This control adjusts the maximum width of the multipath trace display along the horizontal scale of the indicator screen.

LEFT GAIN (VERTICAL) AUDIO CONTROL

This control adjusts the maximum vertical indicator trace deflection from a left channel audio signal.

RIGHT GAIN (HORIZONTAL) AUDIO CONTROL

This control adjusts the maximum horizontal indicator trace deflection from a right channel audio signal.

SIGNAL STRENGTH INPUT (TP 1)

This input connects to a McIntosh tuner Test Point 1, which supplies a voltage proportional to Signal Strength for vertical deflection of the indicator trace.

DEVIATION INPUT (TP 2)

This input connects to a McIntosh tuner Test Point 2, which supplies a voltage proportional to deviation of the FM transmission for horizontal deflection of the indicator trace.

LEFT AUDIO INPUT

This input connects to the left output of a tuner, preamplifier or power amplifier. The left channel audio signal voltage causes ver-

tical deflection of the indicator trace. This input jack is in parallel with the left audio output jack.

LEFT AUDIO OUTPUT

This output jack is in parallel with the left Audio input jack. This parallel connection makes it convenient for connecting a preamplifier or tuner output to both the MI-2 and the power amplifier.

RIGHT AUDIO INPUT

This input connects to the Right output of a tuner, preamplifier or power amplifier. The right channel audio signal voltage causes a horizontal deflection of the indicator trace. This input jack is in parallel with the right audio output jack.

RIGHT AUDIO OUTPUT

This output jack is in parallel with the Right audio input jack. This parallel connection makes it convenient for connecting a preamplifier or tuner output to both the MI-2 and the power amplifier.

1A SLO BLO

A 1 ampere SLO-BLO fuse protects the MI-2 indicator circuits. This fuse does not protect additional equipment connected to the back panel AC outlet.

350 WATTS AC OUTLET

A 117 volt AC outlet is provided for extra equipment drawing as much as 350 watts power. The outlet is not fused and is on whenever the MI-2 power cord is connected to an AC outlet.

INSTALLATION

The McIntosh MI-2 Indicator may be installed on a table, on a shelf, in a custom built-in cabinet, or in a professional equipment rack. The MI-2 may be mounted directly above a tuner or at either side, whichever is more convenient. For best appearance in an open installation, it is suggested that you mount the MI-2 in the attractive McIntosh Model L10W and L10W0 finished wood cabinet.

The MI-2 may be mounted in panels up to 1 inch in thickness. If the panel is at least ¼ inch or more in thickness, the indicator will be adequately supported by the four front panel mounting screws. In cases where the front panel may be thin or flexible, a shelf is necessary to support the weight of the indicator. A shelf should not be required when the MI-2 is mounted in a metal rack panel.

An MI-2 cabinet installation should provide at least 13¾ inches behind the mounting panel for clearance of leads and connectors. Allow inside dimensions of at least 16½ inches in width and 5 inches in height for adequate air circulation. The back panel of the MI-2 cabinet should be left as open as possible for best ventilation. Avoid mounting the indicator directly over a power amplifier. Adequate ventilation will insure your indicator a long and trouble-free life.



Figure 11. Positioning the Mounting Template Over Proposed Area to be Cutout.

1a. Position the MI-2 mounting template over the area to be cut out for the installation.

NOTE

The design of the mounting template allows you to position or locate the cutout either from the front or the back of the panel to which the MI-2 is to be mounted. If the MI-2 is to rest on a shelf it is necessary to locate the cutout from the back of the panel.

1b. If the MI-2 is to be located from the back of the panel, the following steps will help you.

Scribe a vertical centerline through the exact center of the cutout area on the back of the panel.

Place the template against the back of the panel and match the template centerline with the scribed cutout centerline.

If the MI-2 is to rest on a shelf then make sure the bottom of the mounting template is touching the shelf.

1c. Before marking the two locating holes ("c" holes on the mounting template) take special note that there are two small diameter "c" holes and two 3/16" diameter larger

holes. In order to have the MI-2 rest on the shelf follow these instructions carefully.

Mark with a pointed instrument the two small diameter holes.

Drill these two holes through with a 3/16" diameter drill making sure they are perpendicular to the panel.

Now position the template on the front of the panel by aligning the 3/16" diameter "c" holes of the template with the drilled holes.

Proceed to Step 2 now.



Figure 12. Marking the Cutout Indications.

2. Mark the "A" and "B" drill holes and the four corners.

Join the corners using the edge of the template as a straight edge.

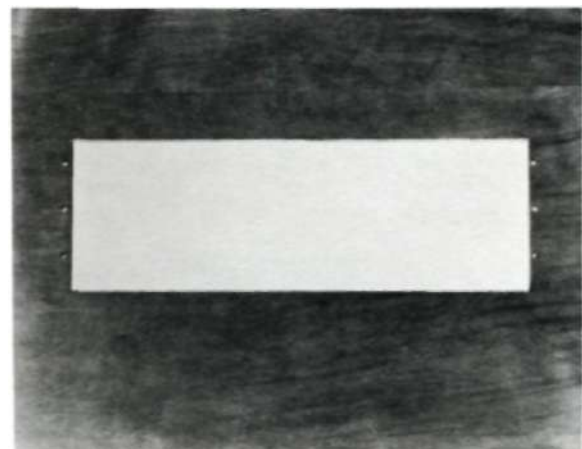

Figure 13. MI-2 Installation Cutout.

3. Drill the mounting holes and cut out the rectangular hole.

4. Secure the mounting strips to the panel using two of the four flat head screws provided.

In the hardware package are 4 flat head screws and 8 fillister-head screws for varying

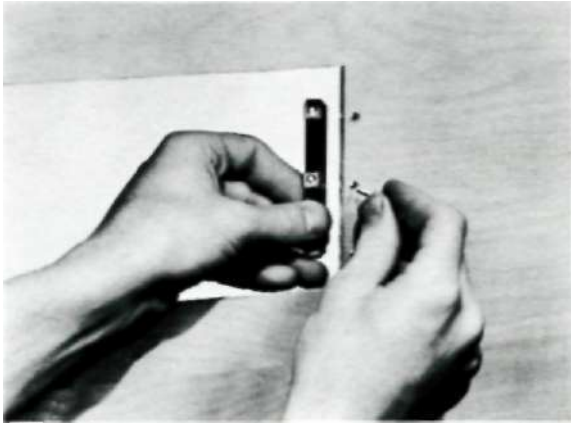

Figure 14. Securing Mounting Strips To Installation Cutout.

panel thicknesses.

Insert a screw in the center holes ("B" holes). Tighten so that the screw pulls into the wood.

5. Prepare the equipment by: (A) removing the shipping skid attached to the chassis, (B) removing the four plastic feet fastened under the chassis, and (C) removing the two metal panel end caps from the front panel by pulling them sidewise away from the panel.

Note, the metal end caps may have been packed separate, already removed from the front panel: if this is the case, disregard this last instruction.)

6. Insert the power cord through the opening. Slide the unit fully into the cabinet.

7. Secure the MI-2 to the panel using 4 of the fillister head machine screws. These screws should pass through the MI-2 flange,

through the wood panel, and into the fastening strip attached to the inside of the panel. The screws should be moderately tightened.

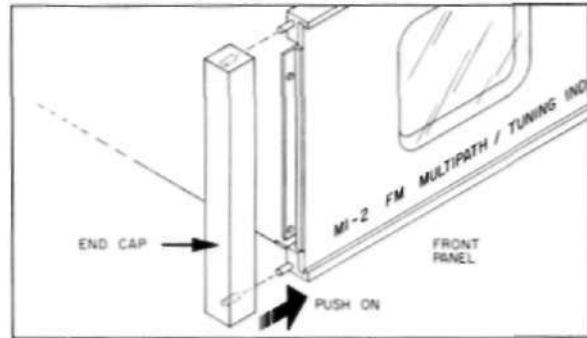

Figure 15. Fitting the End Caps to the Panel.

Finally attach the end caps to the MI-2 panel by sliding them onto the pins projecting from the panel ends. Spring tension will hold the end caps in position.

MOUNTING IN THE L10W AND L10W0 CABINET

The McIntosh L10W and L10W0 cabinets are supplied with complete instructions and all necessary hardware for installing the MI-2 Indicator.

The dimensions of the L10W and L10W0 cabinets are 17 inches wide by $6\frac{5}{8}$ inches high, including mounting feet, by $14\frac{3}{8}$ inches deep including tuner front panel and control knobs.

CONNECTING

TWO PAIRS OF 3 FOOT LONG LOW-LOSS SHIELDED CABLES ARE SUPPLIED WITH THE MI-2. USE THESE CABLES TO CONNECT THE MI-2 TO A TUNER FOR MULTIPATH INDICATION. A PAIR OF 6 FOOT LONG SHIELDED CABLES ARE SUPPLIED FOR CONNECTING THE MI-2 IN AUDIO CIRCUITS.

CONNECTING TO McINTOSH MR67 TUNER

Connect a 3 foot low-loss shielded cable from the MR67 TP1 (Test Point 1 jack on top of the tuner chassis) to the Signal Strength (vertical) Input on the MI-2.

Connect a second 3 foot low-loss shielded

cable from the MR67 TP2 (Test Point 2 jack on top of the tuner chassis) to the Deviation (horizontal) Input on the MI-2.

CONNECTING TO McINTOSH MX110 TUNER-PREAMPLIFIER WITH Z OR X SERIAL NUMBERS

Connect a 3 foot low-loss shielded cable from the MX110 TP1 (Test Point 1 jack on top of the tuner chassis) to the Signal Strength (vertical) Input on the MI-2.

Connect a second 3 foot low-loss shielded cable from the MX110 TP2 (Test Point 2 jack on top of the tuner chassis) to the Deviation (horizontal) Input on the MI-2.

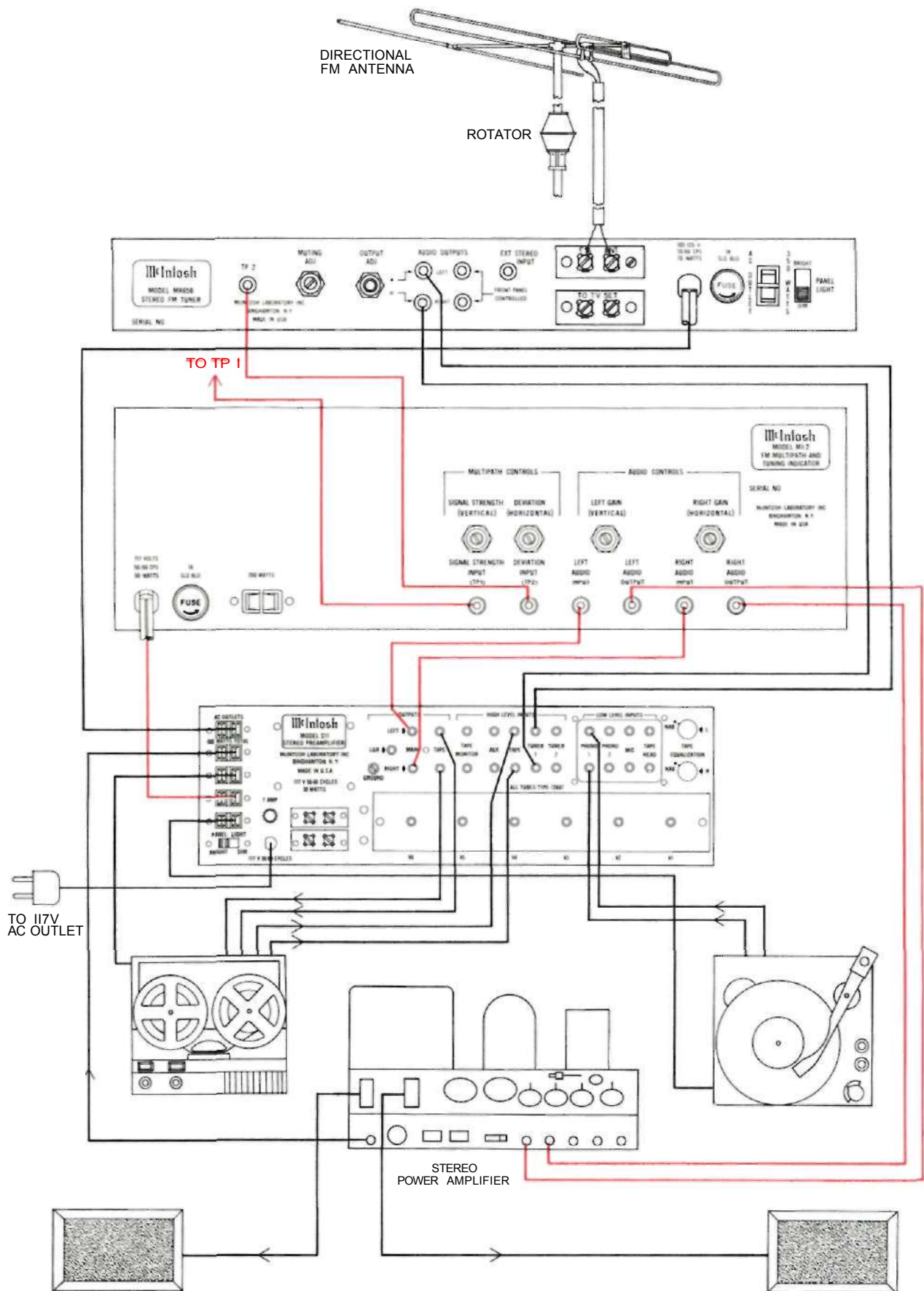

Figure 16. MI-2 Typical Hook-Up.

CONNECTING TO McINTOSH MX110 TUNER-PREAMPLIFIER WITH M SERIAL NUMBERS

Remove capacitor C130 (.005 MF) connected between the test point and ground.

Solder the center lead of a 1 foot low-loss shielded cable to the junction point of R139 (10K) and C125 (.1 MFD). Solder the outer shield of the cable to the tuner chassis ground. Use one of the 1 foot long low-loss shielded cables, stripped and tinned on one end, (female jacks on the other end) supplied with the MI-2.

Use a connector with male plugs to connect the soldered in cable from the tuner to the Deviation (horizontal) Input on the MI-2.

Connect a 3 foot low-loss shielded cable from the test point (on top of tuner chassis) to the Signal Strength (vertical) Input on the MI-2.

CONNECTING TO McINTOSH MR65B TUNER

Remove capacitor C27 (.005 MFD) connected between TP1 and chassis ground. MR65B tuners serial numbers 300U0 and above do not have this capacitor.

Connect a 3 foot low-loss shielded cable from the MR65B TP1 (Test Point 1 on tuner back panel) to the Signal Strength (vertical) Input on MI-2.

Connect a 3 foot long low-loss shielded cable from the MR65B TP2 (Test Point 2 on top of tuner chassis) to the Deviation (horizontal) Input on the MI-2.

CONNECTING TO McINTOSH MR65 and 65A

Remove capacitor C31 (.005 MFD) connected between the test point and ground.

Connect a 3 foot low-loss shielded cable from the MR65A Test Point (jack on top of tuner chassis) to the Signal Strength (vertical) input on the MI-2.

Connect a 3 foot low-loss shielded cable from the MR65A MPX out jack on the tuner back panel to the Deviation (horizontal) Input on the MI-2.

If an external multiplex adapter is being used with the MR65, a "Y" connector will be needed in the MPX output jack. This allows both the MPX adapter and the lead to the MI-2 to be connected.

CONNECTING TO McINTOSH MR66 TUNER

Remove capacitor C125 (.005 MFD) connected between the test point and ground.

Connect a 3 foot low-loss shielded cable from the TEST POINT (on top of tuner chassis) to the Signal Strength (vertical) Input on the MI-2.

Connect a 3 foot low-loss shielded cable from the FM Multiplex output jack on the tuner back panel to the Deviation (horizontal) Input on the MI-2.

CONNECTING TO McINTOSH MR55A TUNER

Remove the feed-through capacitor L43 (1000 MMF) connected to TP-1. This capacitor can best be removed by unsoldering.

Solder the center lead of a 1 foot low-loss shielded cable to the Test Point end of R27 (100K resistor). Solder the outer shield of the cable to the chassis where the feed-through capacitor was soldered. The cable can feed through the hole in the chassis where the capacitor was soldered. Use one of the 1 foot long low-loss shielded cables, stripped and tinned on one end, (female jacks on the other end) supplied with the MI-2.

Use a connector with male plugs to connect the soldered-in cable to the Signal Strength (vertical) Input on the MI-2.

Connect a 3 foot low-loss shielded cable from the multi-out (multiplex output) jack on the tuner to the Deviation (horizontal) Input.

If a multiplex adapter is being used with the MR55A, a "Y" connector will be needed in the MULTI-OUT Jack. This allows both the multiplex adapter and the lead to the MI-2 to be connected.

CONNECTING TO McINTOSH MR55 TUNER

Solder a wire across resistor R62 (1 meg) connected to the test point on the tuner chassis.

Connect a 3 foot low-loss shielded cable from the test point on top of the tuner chassis to the Signal Strength (vertical) Input on the MI-2.

Connect a 3 foot low-loss shielded cable from the MULTIPLEX OUTPUT jack on the tuner to the Deviation (horizontal) Input on the MI-2.

CONNECTING TO ALL OTHER TUNERS

Connect a low-loss shielded cable from the input to the first FM limiter through a 100 K resistor, to the Signal Strength (vertical) Input on the MI-2.

Connect a low-loss shielded cable from the discriminator output (ahead of the de-emphasis network) to the Deviation (horizontal) Input on the MI-2.

OPERATING INSTRUCTIONS

MULTIPATH AND TUNING INDICATION

1. Turn the MI-2 power switch to ON.
2. Turn the SCOPE TEST switch to TEST.
3. Adjust the HORIZONTAL POSITION front panel control until the trace dot is centered horizontally on the indicator screen. Calibration lines are provided on the indicator face for centering purposes.
4. Adjust the VERTICAL POSITION front panel control until the trace dot is positioned at the bottom center of the vertical scale (See Figure 17.)

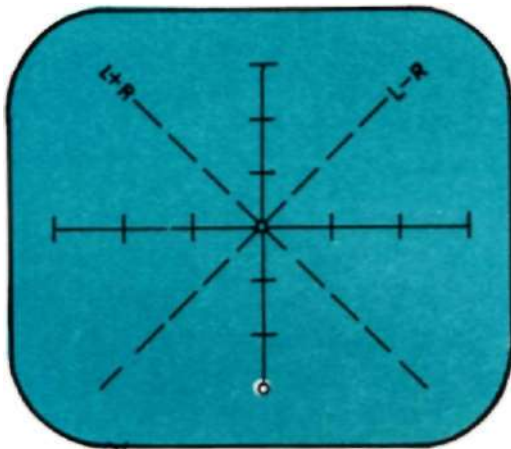

Figure 17. Trace Dot Positioned at Bottom Center of Vertical Scale.

5. Adjust the INTENSITY and FOCUS controls for a sharp and clear trace dot.
6. Turn the SCOPE TEST switch to MULTIPATH position.
7. Turn the tuner tuning dial to the desired FM station, either stereo or monophonic.
8. Observe the trace pattern on the MI-2 Indicator screen. If the pattern is uniform and relatively smooth, little or no multipath is present. If the pattern is irregular with vertical traces, multipath is present.

The average height of the trace above the base line indicates the relative signal strength of the station being received.

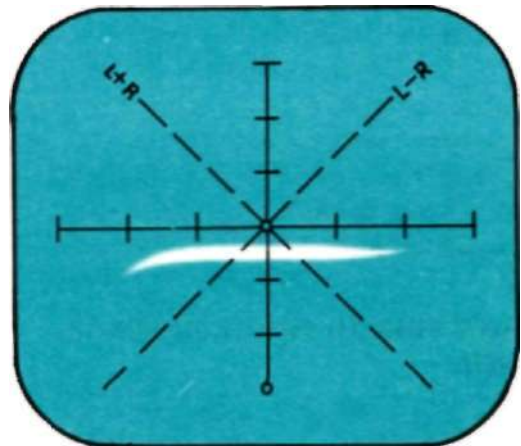

Figure 18. Uniform and Relatively Smooth Trace With Little or No Multipath Present (80% Modulation).

9. Rotate the tuner antenna, while watching the MI-2 Indicator screen. Stop the antenna in the position where the trace is the smoothest curve. In this position there is the least multipath.

TYPICAL INDICATIONS

The 19KC carrier from a station broadcasting multiplex stereo will keep the Indicator trace from closing down to a dot with no station modulation.

You may notice that Multipath is almost independent of the strength of the incoming signal. Strong local stations can be as critical as distant stations with respect to Multipath.

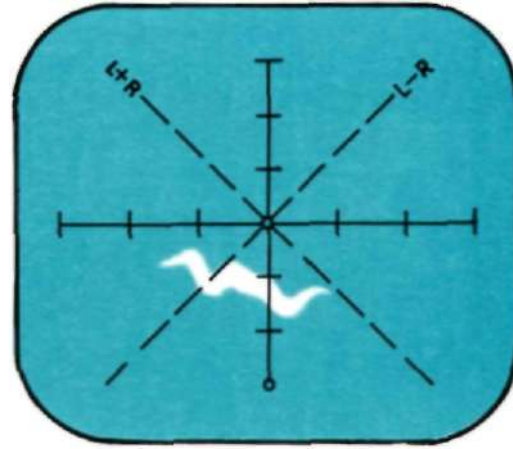
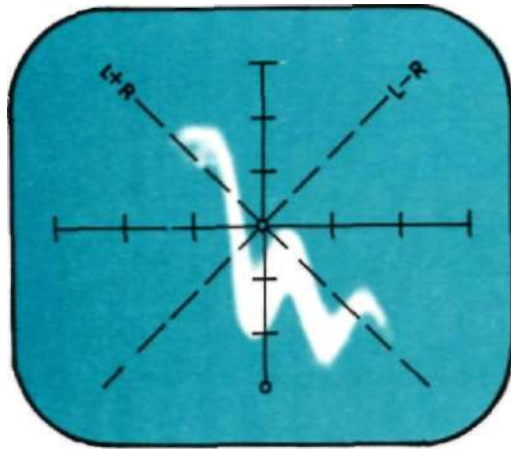
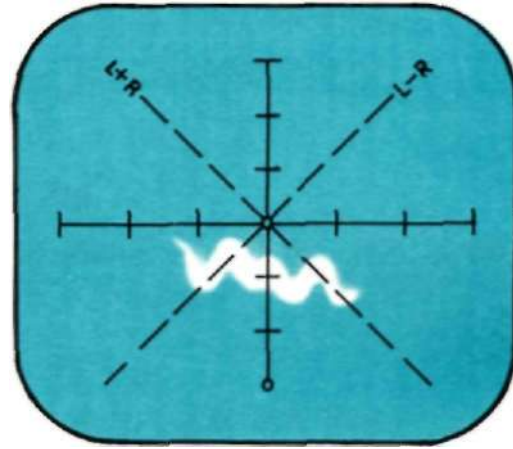
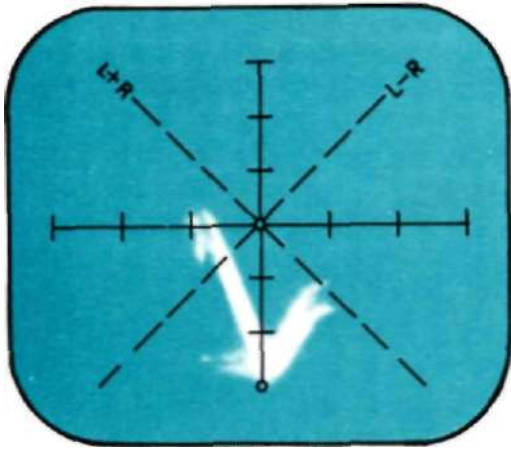
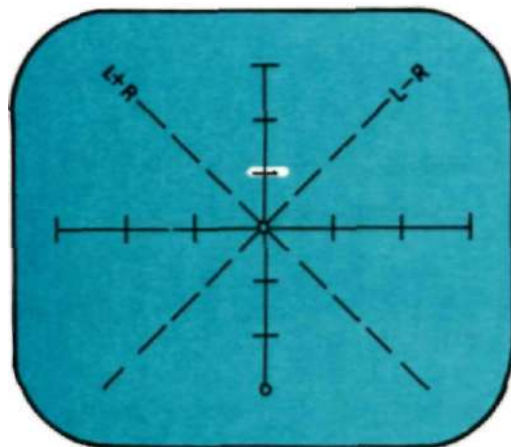

Figure 19. Irregular Pattern With Vertical Traces
Indicating The Presence of Multipath.



The 19KC carrier from a station broadcasting multiplex stereo will keep the Indicator trace from closing down to a dot with no station modulation.

Figure 20. 19KC Pilot.

SIGNAL STRENGTH MULTIPATH CONTROL

1. Tune in a relatively strong local signal with the antenna positioned for minimum multipath.

2. Adjust the SIGNAL STRENGTH (vertical. Multipath control on the back panel until the pattern on the indicator screen is about $\frac{3}{4}$ inch from the top of the vertical scale.

DEVIATION MULTIPATH CONTROL

1. Tune in a relatively strong local signal with the antenna positioned for maximum multipath.
2. Adjust the DEVIATION (horizontal) Multipath control until the horizontal pattern (loudest signal from the station does not extend over the ends of the horizontal scale of the indicator screen.

L & R AUDIO INDICATIONS

1. Turn the MI-2 Power switch to ON.
2. Turn the SCOPE TEST switch to TEST.
3. Adjust the HORIZONTAL POSITION front panel control until the trace dot is cen-

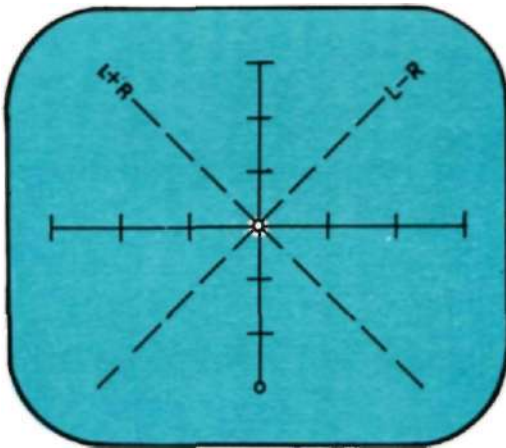
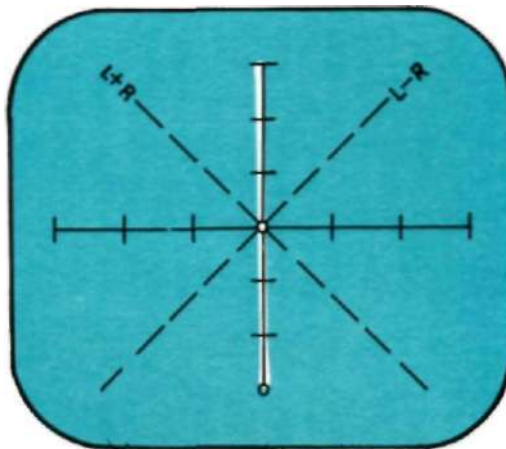

Figure 21. Trace Dot Positioned at Center of Screen.

tered horizontally on the Indicator screen. Calibration lines are provided on the Indicator face for centering purposes.

4. Adjust the vertical position control until the trace dot is positioned at the bottom of the center vertical scale.
5. Adjust the INTENSITY and FOCUS controls for a sharp and clear trace dot.
6. Turn the SCOPE TEST switch to L & R Audio.
7. Set the tuner to an FM Station broadcasting a monophonic program.
8. Adjust the LEFT GAIN and RIGHT GAIN controls on the MI-2 until the incoming program causes the Indicator trace to align directly over the L + R Line.



LEFT CHANNEL ONLY
(22a)

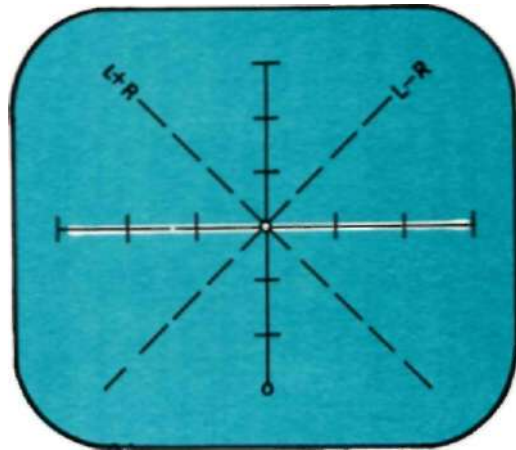

RIGHT CHANNEL ONLY
(22b)

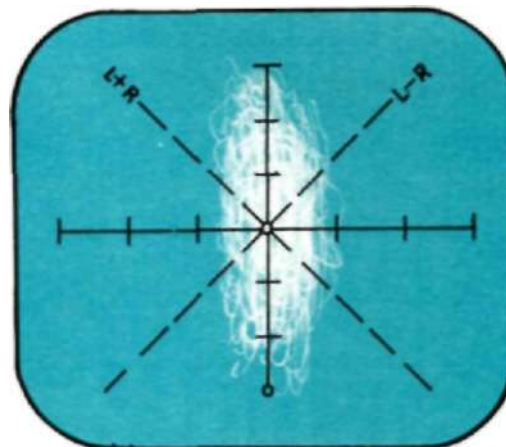

STEREO-LEFT CHANNEL
NOT EQUAL TO RIGHT
CHANNEL
(22c)

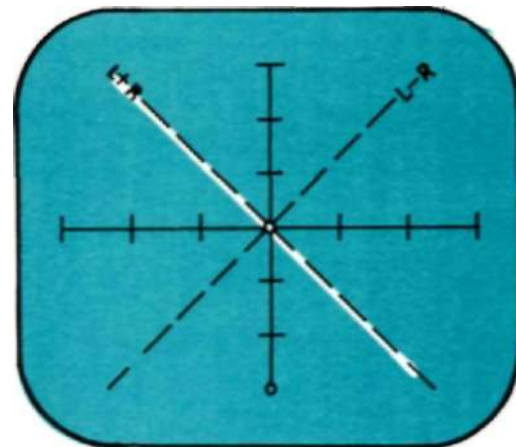

STEREO-LEFT CHANNEL EQUAL TO
RIGHT CHANNEL
(22d)

Figure 22. Audio Presentations.

Your MI-2 will give you many years of pleasant and satisfactory performance. If you have any questions concerning the operation or maintenance of this tuner please contact:

Customer Service
McIntosh Laboratory Inc.
2 Chambers Street
Binghamton, New York

Our telephone number is 723-5491.
The direct dial area code is 607.

GUARANTEE

McIntosh Laboratory Incorporated guarantees this equipment to perform as advertised. We also guarantee the mechanical and electrical workmanship and components of this equipment to be free of defects for a

period of 90 days from date of purchase. This guarantee does not extend to components damaged by improper use nor does it extend to transportation to and from the factory.

3-YEAR FACTORY SERVICE CONTRACT

An application for a FREE 3-YEAR FACTORY SERVICE CONTRACT is included in the pocket in the back cover of this manual. The FREE 3-YEAR FACTORY SERVICE CONTRACT will be issued by McIntosh Laboratory upon receipt of the completely filled out application form. If the application is not

mailed to McIntosh Laboratory, only the services offered under the standard 90-day guarantee will apply on this equipment. TAKE ADVANTAGE OF 3 YEARS OF FREE FACTORY SERVICE BY FILLING IN THE APPLICATION NOW.

In Canada: manufactured under license by:

McCurdy Radio Industries, Ltd.
22 Front Street West
Toronto, Canada

Design subject to change without notice

McIntosh LABORATORY INC.

2 CHAMBERS STREET, BINGHAMTON, N. Y.

Made in U.S.A.

Phone-Area Code 607-723-5491