

Bang & Olufsen

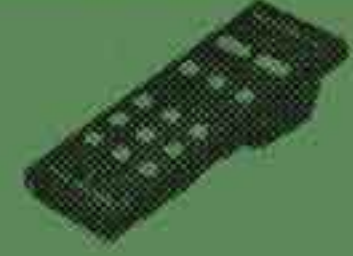

Beocenter 7000
Type 1801

**INFORMATION TECHNIQUE
DES PRODUITS**



SERVICE APRES VENTE
 (mesures éventuelles)
 Mesure à effectuer sur un
 amplificateur de sortie
 effectués

Emplacement de la lampe
 du cadran

S'il y a un défaut dans un amplificateur de sortie, et qu'il se produit un courant continu à la sortie du haut-parleur, le circuit du fault switch (interrupteur met l'appareil en position STAND-BY. Débrancher ensuite les haut-parleurs, mettre l'appareil en marche et effectuer les mesures, à moins qu'il s'agisse de court-circuits directs dans les amplificateurs de sorties.

Enlever l'ensemble AM. Pousser le boîtier du cadran dans le sens de la flèche (A) Le capot (B) peut maintenant s'ouvrir et la lampe peut être remplacée.

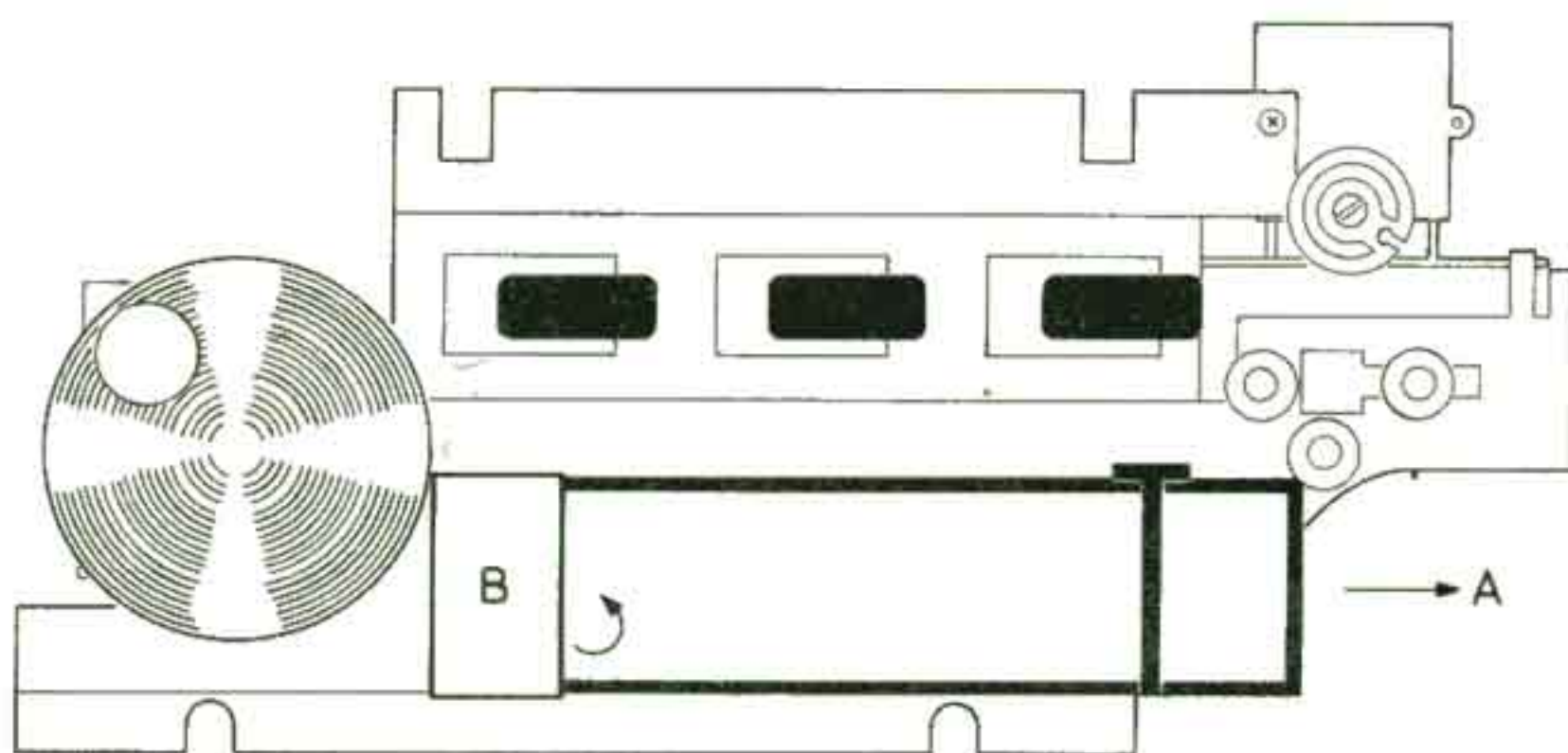

Après le remplacement de la lampe, il faut remettre le boîtier à sa place d'origine.

Enlèvement des charnières

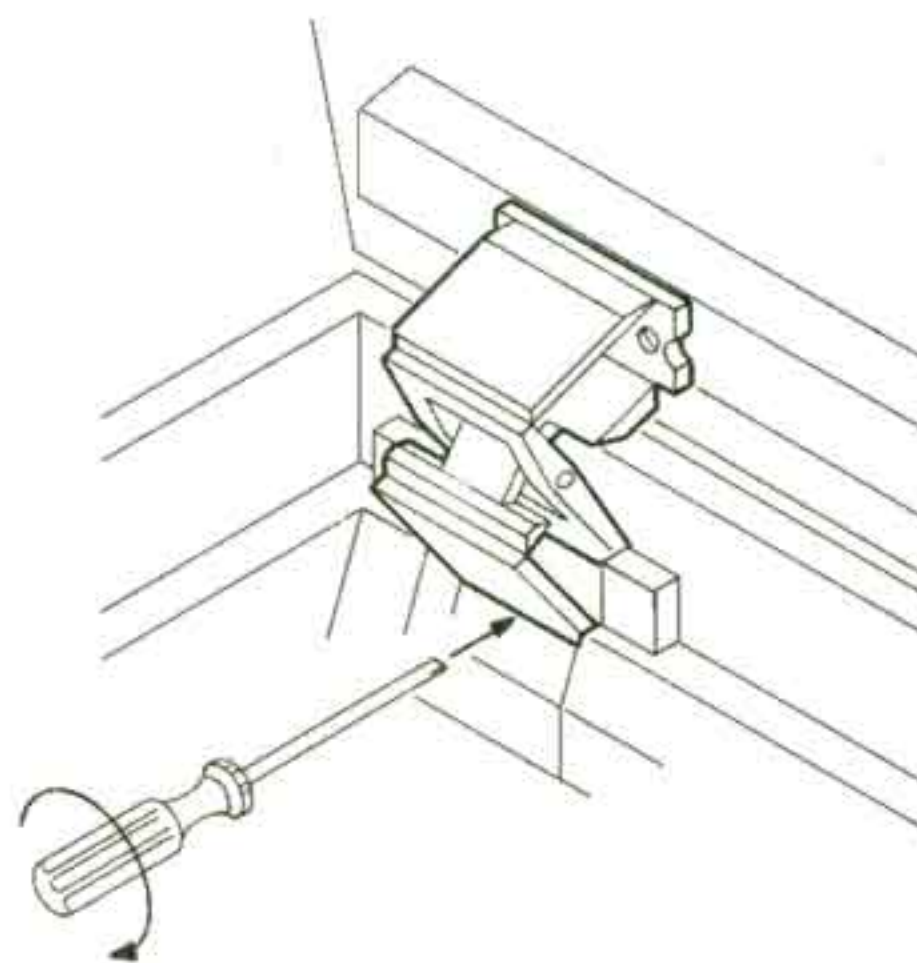

Si on désire enlever la partie de l'ensemble des commandes ou celle de la platine, les charnières peuvent être enlevées par une torsion sous la charnière à l'aide d'un tournevis à lame large et solide.

Entraînement de l'index

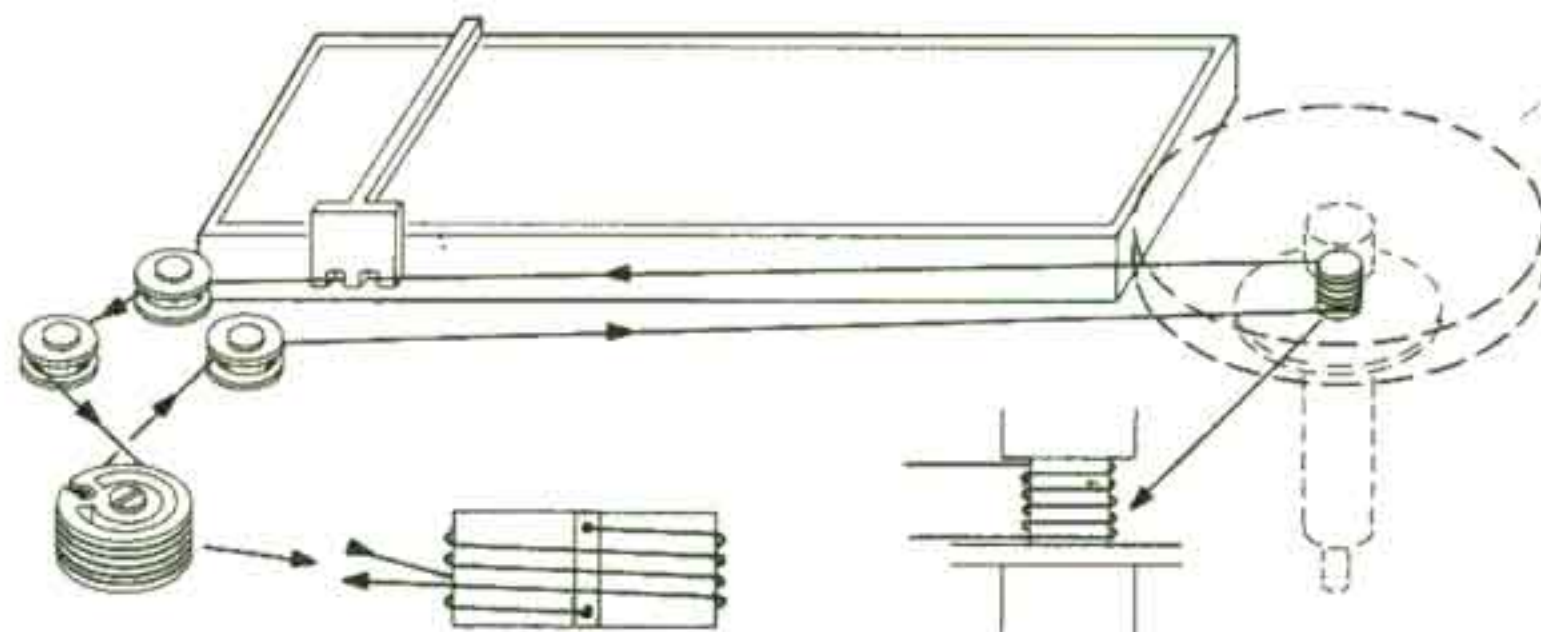

La cordelette de l'index (n° de référence 3955016) doit être coupée sur une longueur d'environ 65 cm.
 Nouer les extrémités de telle manière qu'il y ait 60 cm entre chaque noeud.
 Tourner le condensateur variable vers la droite, puis monter ensuite la cordelette comme il est indiqué sur le schéma

DIAGRAM 1

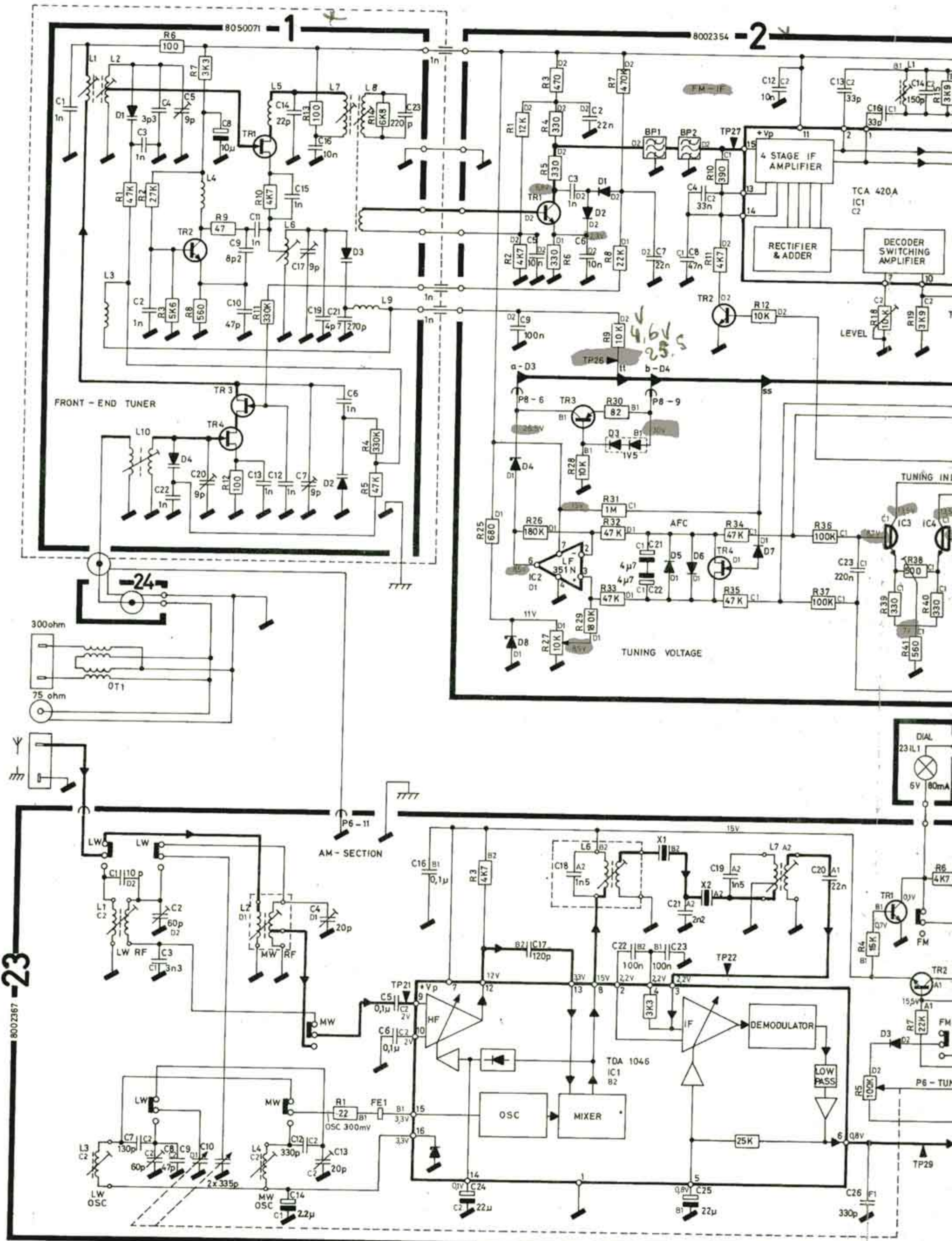

8002367 -23

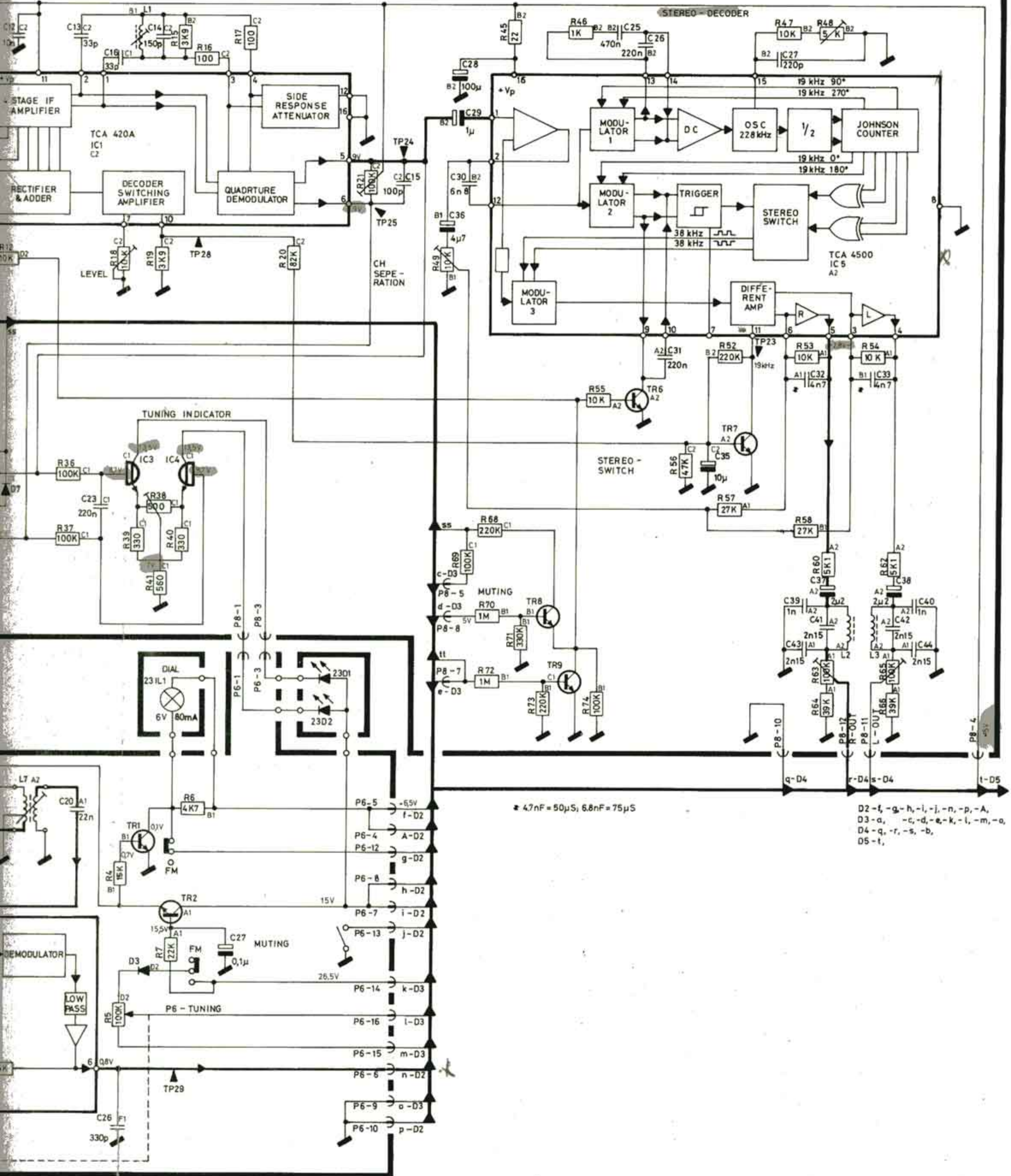
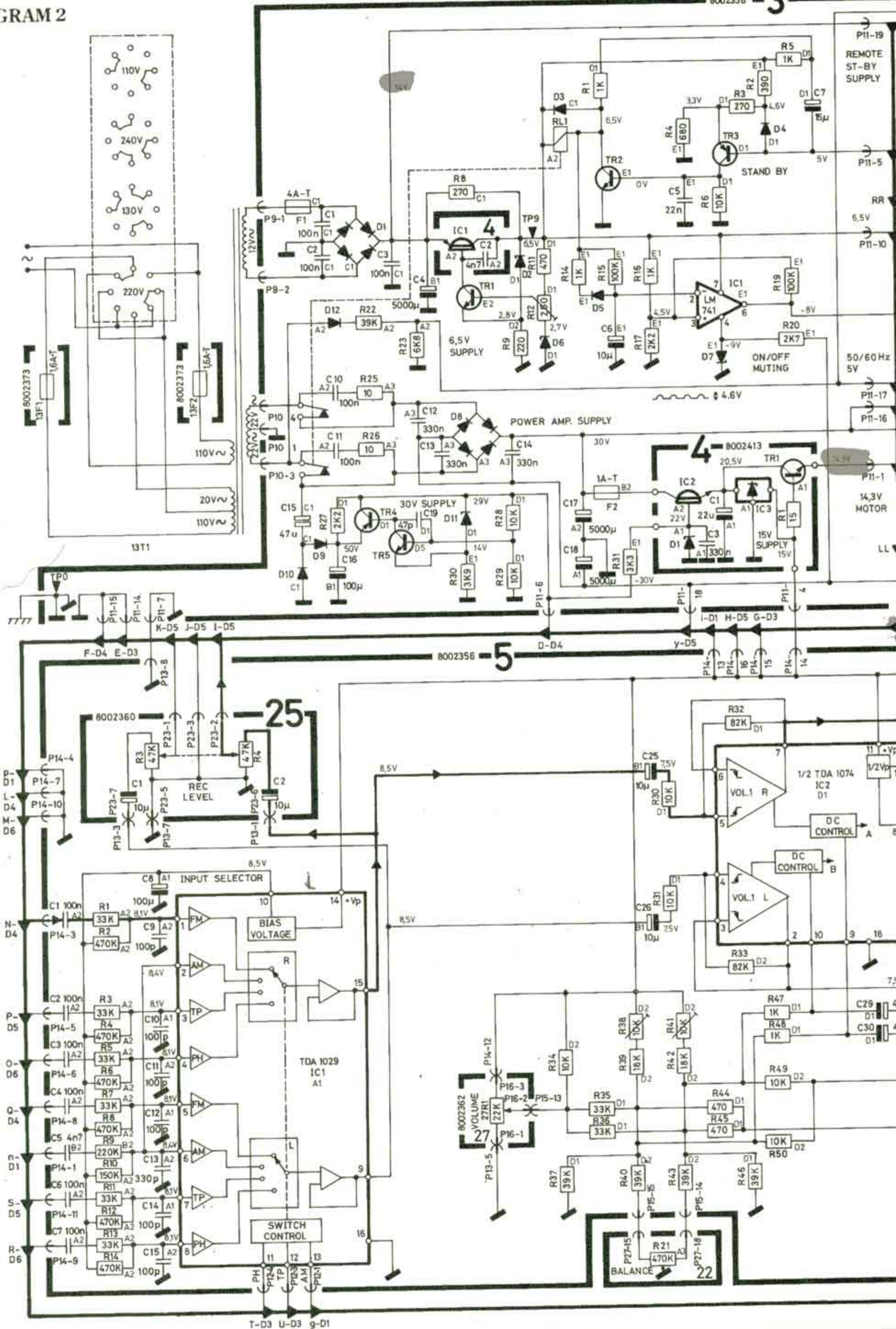
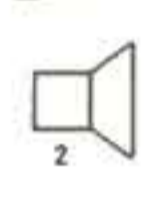
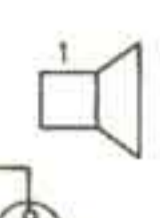
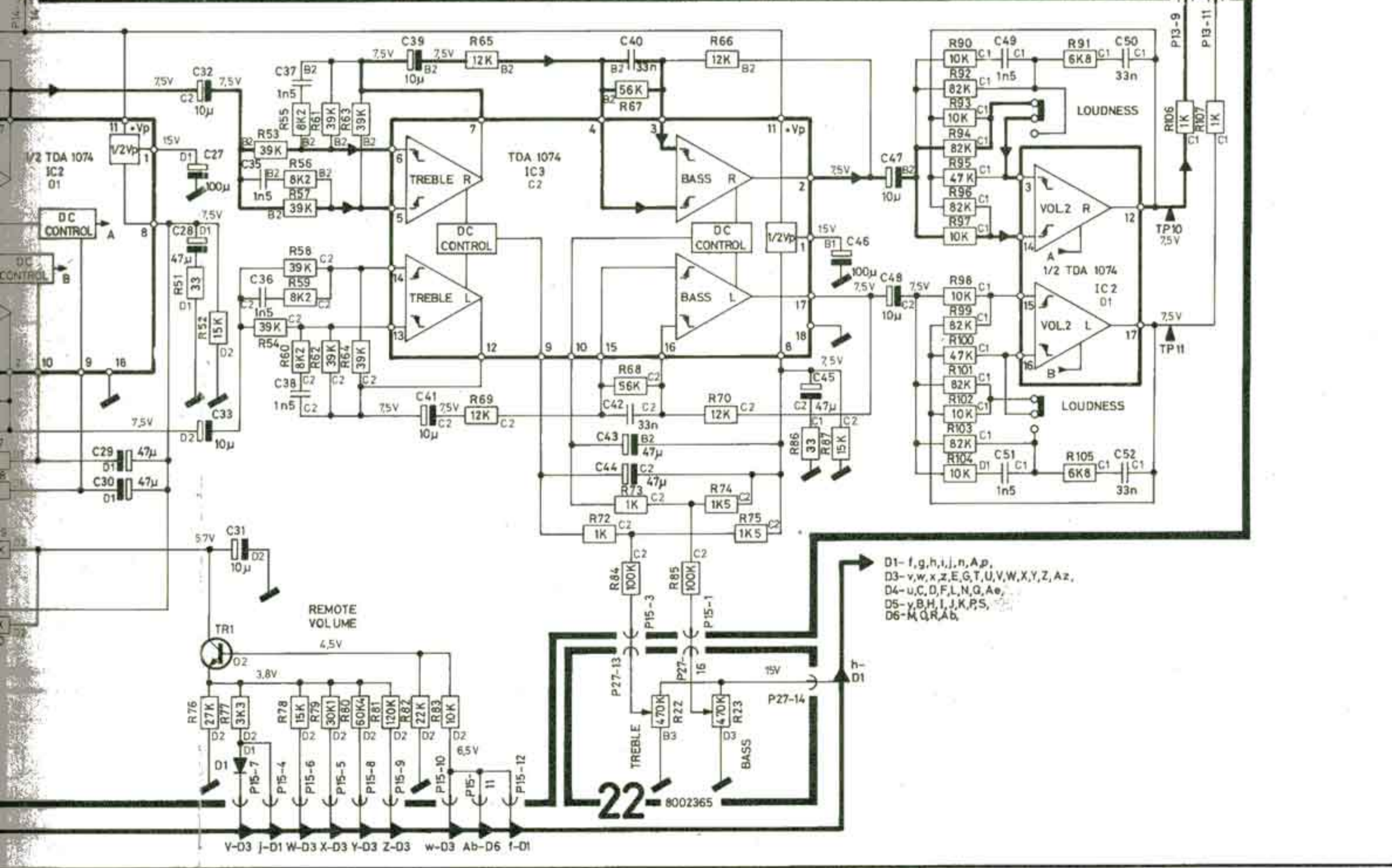
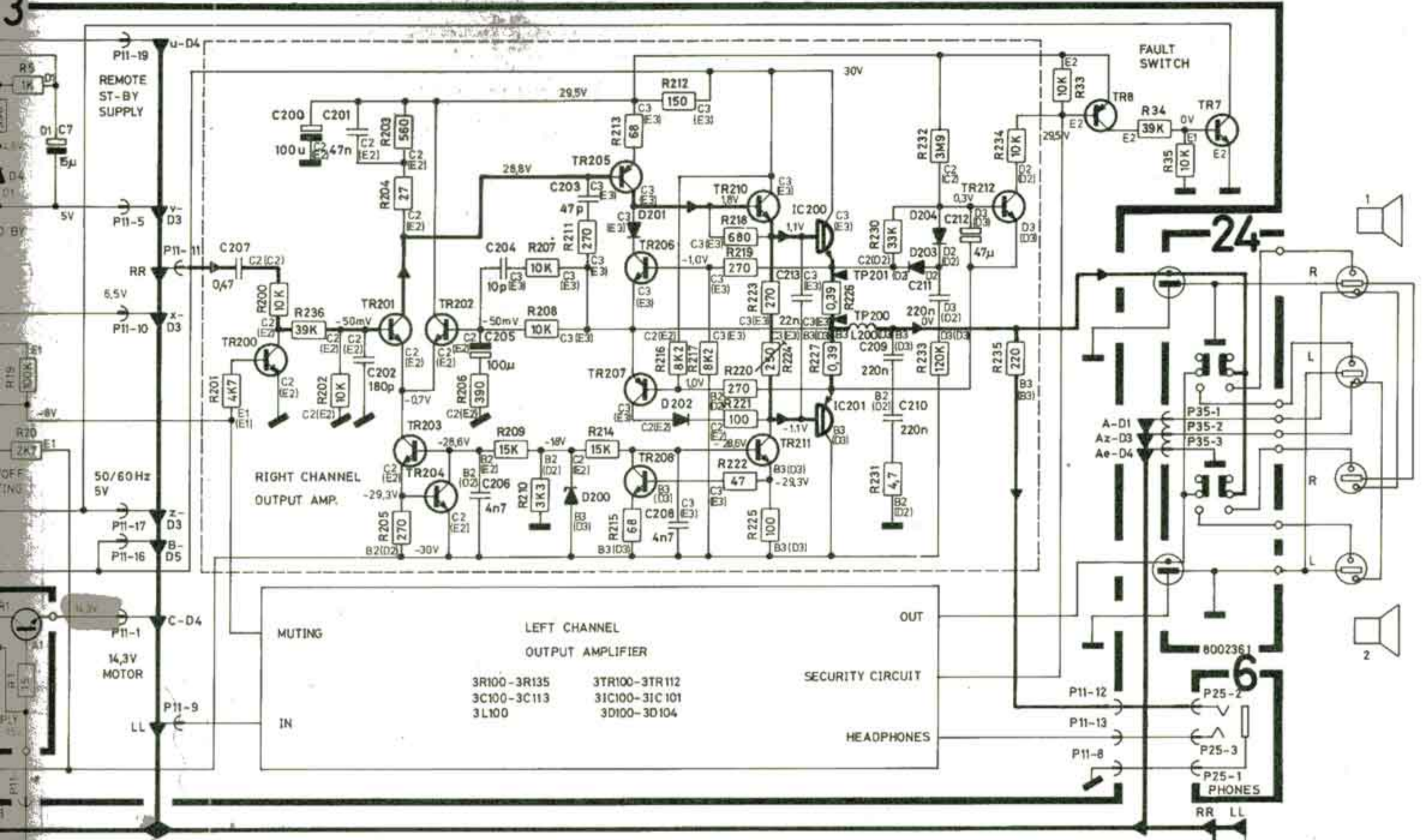

DIAGRAM 2



3



24

6

22

V-D3 J-D1 W-D3 X-D3 Y-D3 Z-D3 w-D3 Ab-D6 f-D1

DIAGRAM 3

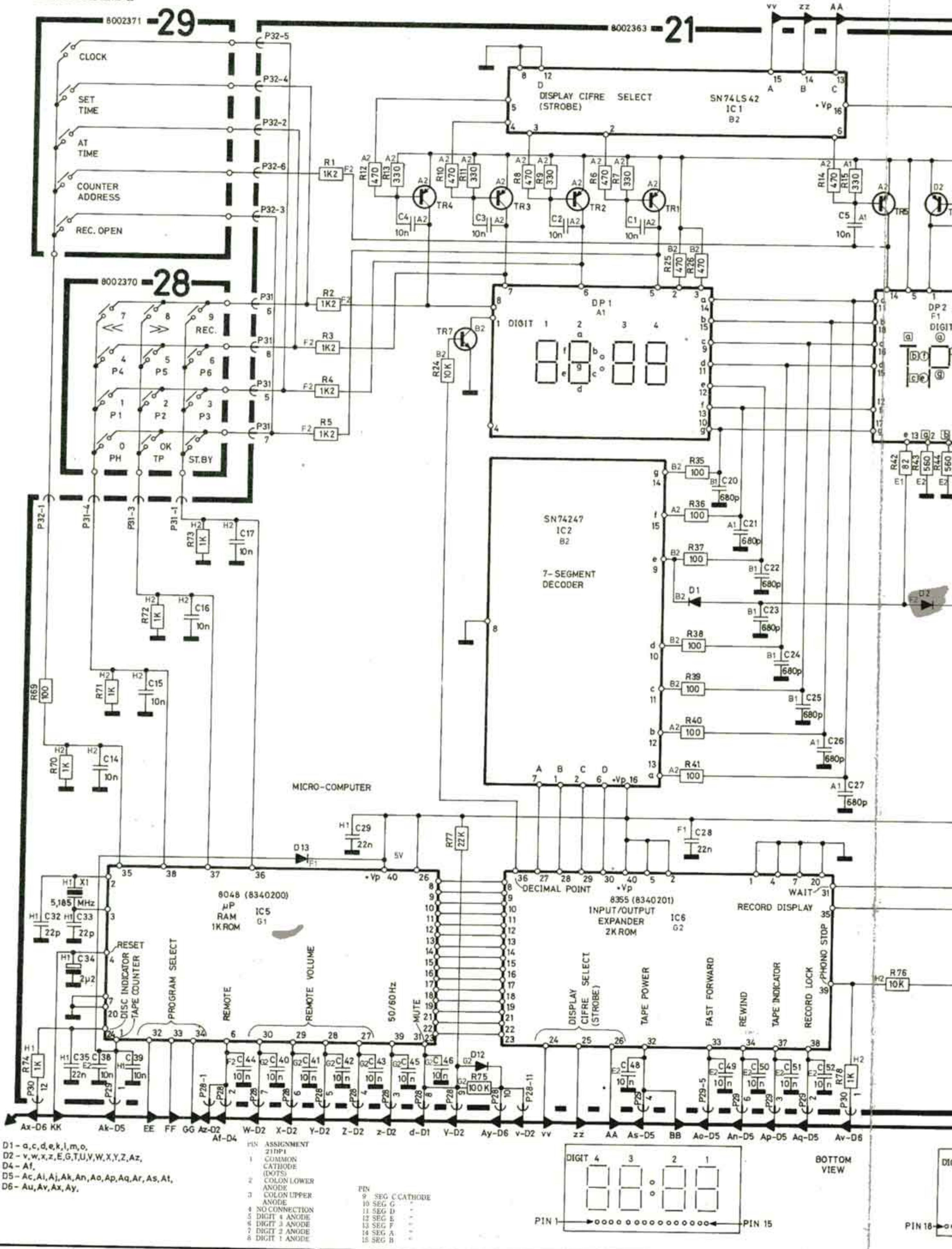

D1 - a, c, d, e, k, l, m, o,
 D2 - v, w, x, z, E, G, T, U, V, W, X, Y, Z, Az,
 D4 - Af,
 D5 - Ac, Ai, Aj, Ak, An, Ao, Ap, Aq, Ar, As, At,
 D6 - Au, Av, Ax, Ay,

PIN ASSIGNMENT
 1 COMMON CATHODE (DOTS)
 2 COLON LOWER ANODE
 3 COLON UPPER ANODE
 4 NO CONNECTION
 5 DIGIT 4 ANODE
 6 DIGIT 3 ANODE
 7 DIGIT 2 ANODE
 8 DIGIT 1 ANODE

PIN
 9 SEG C CATHODE
 10 SEG G
 11 SEG D
 12 SEG E
 13 SEG F
 14 SEG A
 15 SEG B

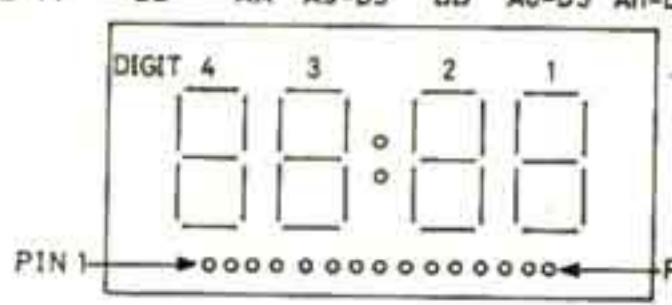

BOTTOM VIEW

PIN 16

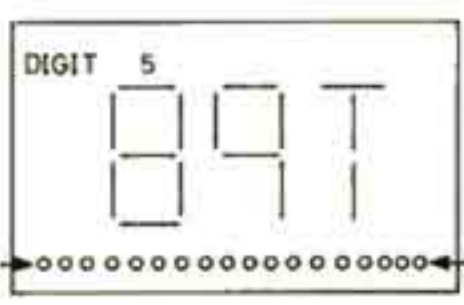
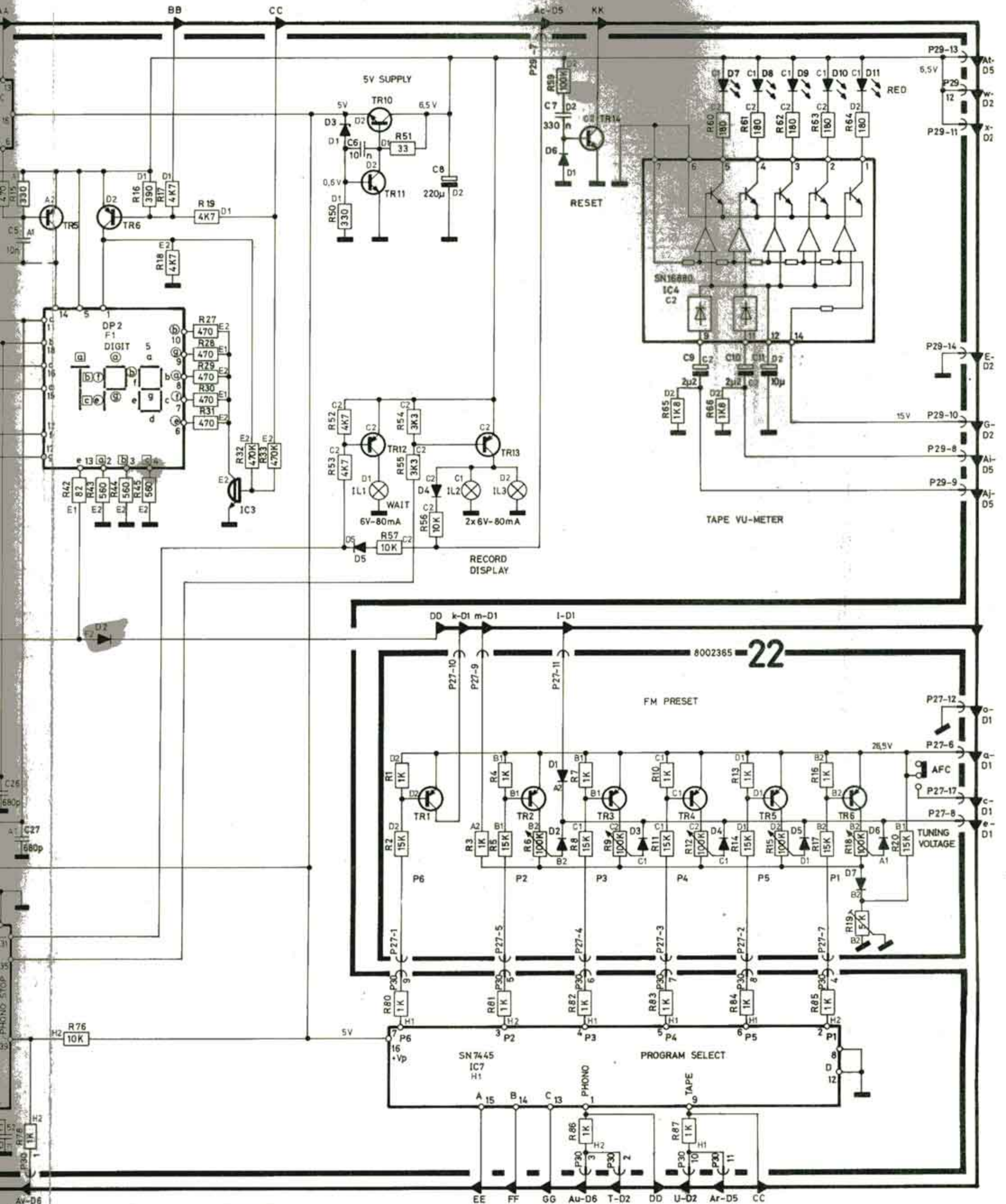

- PIN ASSIGNMENT**
- | | | | | | | |
|-----------------|--------|---------|------------------|---------|------------------|---------|
| 21 DP2 | COMMON | DIGIT F | 6 SEG E CATHODE | DIGIT P | 12 SEG F CATHODE | DIGIT 5 |
| 1 COMMON | ANODE | DIGIT T | 7 SEG F CATHODE | ... | 13 SEG E CATHODE | ... |
| 2 SEG A CATHODE | ... | ... | 8 SEG A CATHODE | ... | 14 COMMON ANODE | ... |
| 3 SEG B CATHODE | ... | ... | 9 SEG G CATHODE | ... | 15 SEG D CATHODE | ... |
| 4 SEG C CATHODE | ... | ... | 10 SEG B CATHODE | DIGIT 5 | 16 SEG C CATHODE | ... |
| 5 COMMON ANODE | ... | ... | 11 SEG A CATHODE | ... | 17 SEG G CATHODE | ... |
| | | | | | 18 SEG B CATHODE | ... |

Bang & Olufsen

DIAGRAM 4

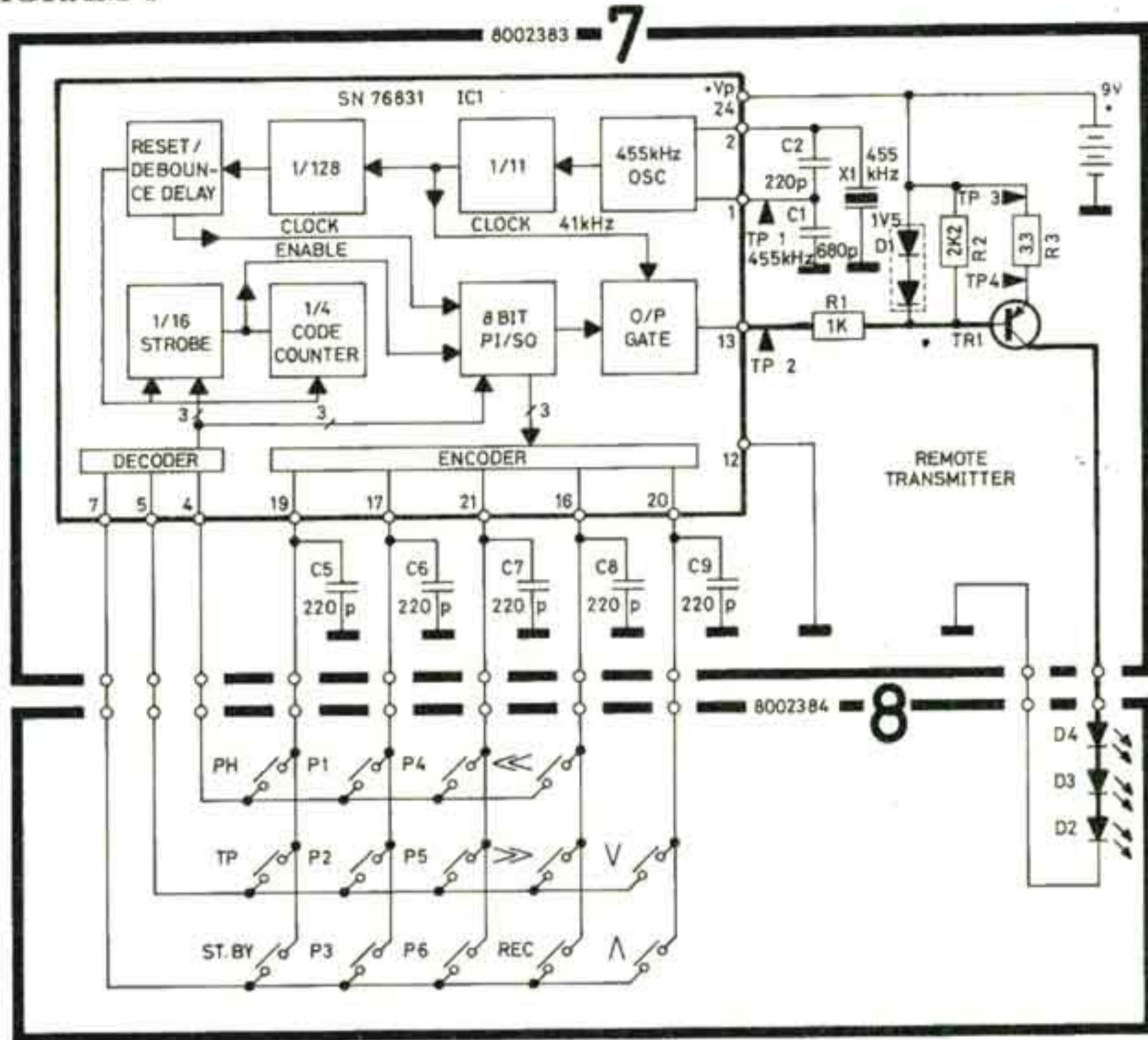

CONTROL MODULE	PINS SHORTED ON 71C1						OUTPUT CODE FROM 71C1									
	4	5	7	16	17	19	20	21	START							
V		X						X	1	1	0	1	0	1	0	0
Λ			X					X	1	1	0	1	0	0	1	0
<<	X			X					1	1	0	0	1	0	0	0
>>		X		X					1	1	0	0	0	1	0	0
REC.			X	X					1	1	0	0	0	0	1	0
P4	X							X	1	0	1	1	1	0	0	0
P5		X						X	1	0	1	1	0	1	0	0
P6			X					X	1	0	1	1	0	0	1	0
P1	X				X				1	0	1	0	1	0	0	0
P2		X			X				1	0	1	0	0	1	0	0
P3			X		X				1	0	1	0	0	0	1	0
PH	X					X			1	0	0	1	1	0	0	0
TP		X				X			1	0	0	1	0	1	0	0
ST-BY			X			X			1	0	0	1	0	0	1	0

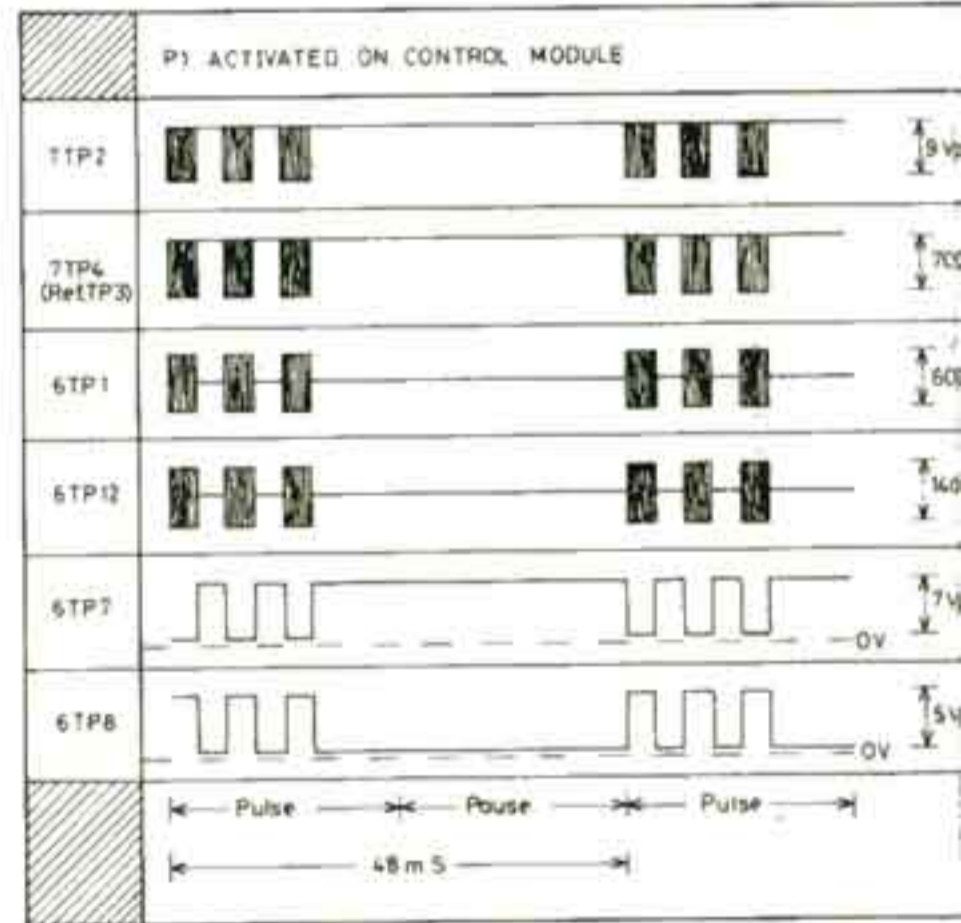

FUNCTION TABLE FOR DIAGRAM 3

FUNCTION TABLE MICRO-COMPUTER																
CONDITIONS	FUNCTION	RESULTS														
		211C5						211C6								
PIN	211C5	211C6	211C6	27	28	29	30	31	32	33	34	32	33	34	35	39
0	PHONO							1	0	0	0	1	1	1	1	0
	P1							1	1	0	0	1	1	1	1	1
	P2							1	0	1	0	1	1	1	1	1
	P3							1	1	1	0	1	1	1	1	1
	P4							1	0	0	1	1	1	1	1	1
	P5							1	1	0	1	1	1	1	1	1
	P6							1	0	1	1	1	1	1	1	1
1	TAPE							1	1	1	1	0	0	0	1	1
	STAND BY							0	1	1	1	1	1	1	1	1
1	REC. OPEN											0	1	1		
1	COUNTER ADDR.											0	1	1		
	P1-REC. PAUSE							1	1	0	0	0	1	1	1	1
	P1-REC.							1	1	0	0	0	0	0	0	1
1	>>											0	0	1	1	
1	<<											0	1	0	1	
	MIN. VOL. (Remote)	0	0	0	0											
	MAX. VOL. (Remote)	1	1	1	1											

FUNCTION TABLE 211C7 (SN 7445)												
FUNCTION	INPUTS				OUTPUT AT PINS							
	D	C	B	A	1	2	3	4	5	6	7	9
PHONO	0	0	0	0	0	1	1	1	1	1	1	1
P1	0	0	0	1	1	0	1	1	1	1	1	1
P2	0	0	1	0	1	1	0	1	1	1	1	1
P3	0	0	1	1	1	1	1	0	1	1	1	1
P4	0	1	0	0	1	1	1	1	0	1	1	1
P5	0	1	0	1	1	1	1	1	1	0	1	1
P6	0	1	1	0	1	1	1	1	1	1	0	1
TAPE	0	1	1	1	1	1	1	1	1	1	1	0
ST-BY	0	1	1	1	1	1	1	1	1	1	1	1

FUNCTION TABLE 211C2 (SN 7442)									
DECIMAL ON DISPLAY	INPUTS				OUTPUTS				
	D	C	B	A	a	b	c	d	e
0	0	0	0	0	0	0	0	0	0
1	0	0	0	1	1	0	0	1	1
2	0	0	1	0	0	0	1	0	0
3	0	0	1	1	0	0	0	0	1
4	0	1	0	0	1	0	0	1	1
5	0	1	0	1	0	1	0	0	1
6	0	1	1	0	0	1	0	0	0
7	0	1	1	1	0	0	0	1	1
8	1	0	0	0	0	0	0	0	0
9	1	0	0	1	0	0	0	0	1

FUNCTION TABLE 211C1 (SN 74LS42)							
INPUTS			OUTPUT AT PINS				
D	C	A	2	3	4	5	6
0	0	0	1	0	1	1	1
0	0	1	0	1	1	1	1
0	1	0	1	0	1	1	1
0	1	1	1	1	0	1	1
0	1	0	0	1	1	1	0
0	1	0	1	1	1	1	0

8002352-6

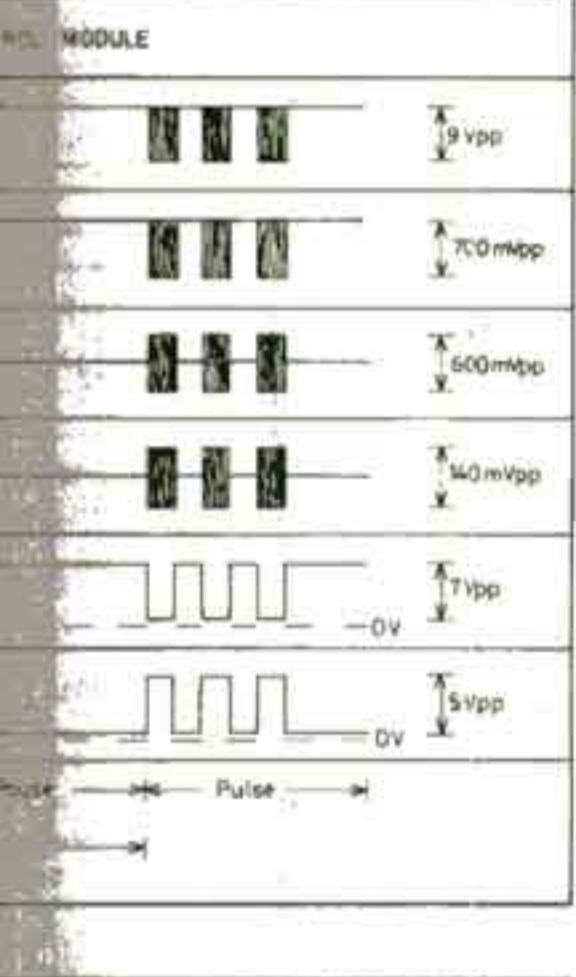
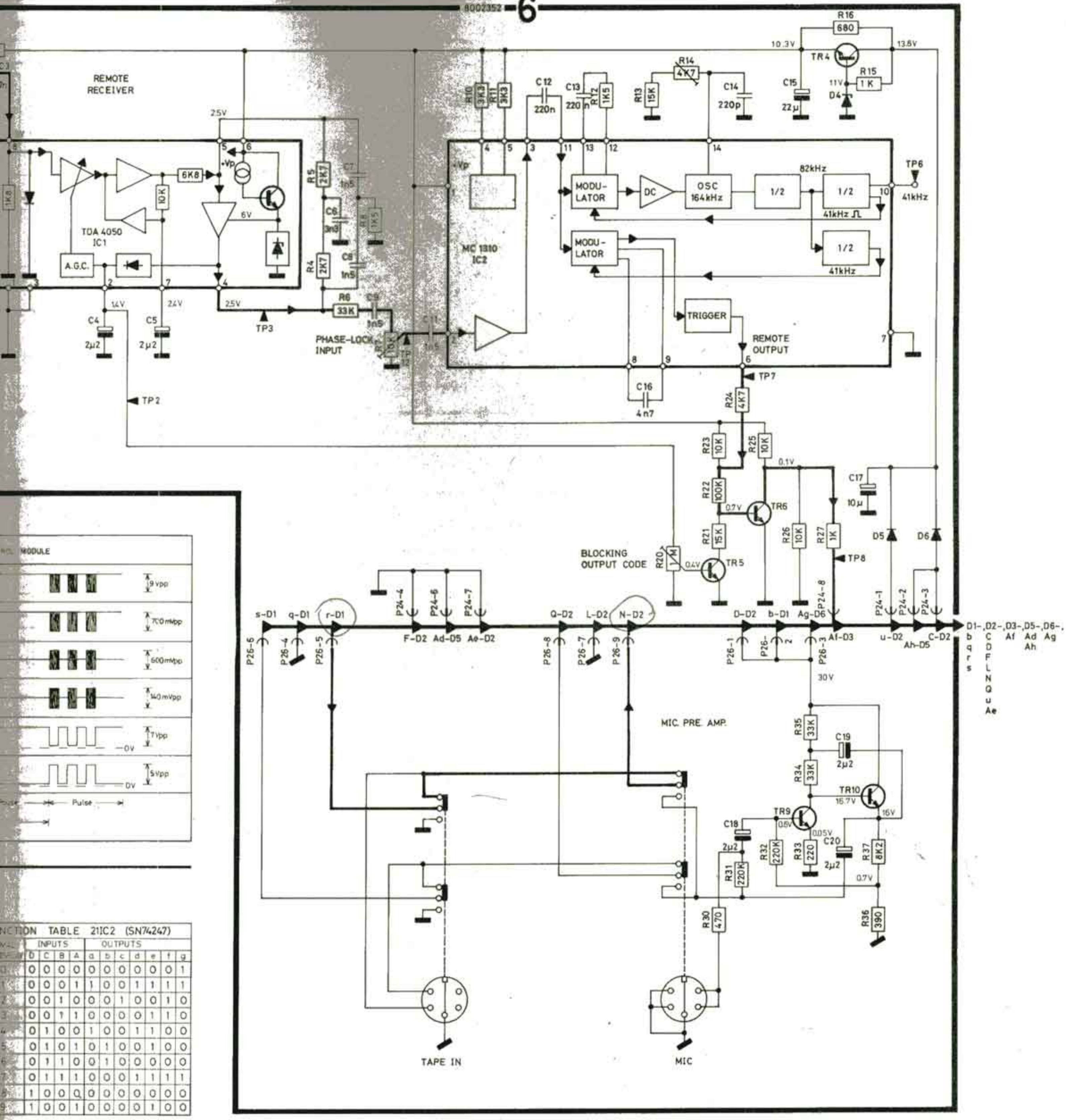

FUNCTION TABLE 21IC2 (SN74247)

A	INPUTS				OUTPUTS					
	B	C	D	A	d	b	c	e	f	g
0	0	0	0	0	0	0	0	0	0	1
0	0	0	1	1	0	0	1	1	1	1
0	0	1	0	0	0	1	0	0	1	0
0	0	1	1	0	0	0	0	1	1	0
0	1	0	0	1	0	0	1	1	0	0
0	1	0	1	0	1	0	0	1	0	0
0	1	1	0	0	1	0	0	0	0	0
0	1	1	1	0	0	0	1	1	1	1
1	0	0	0	0	0	0	0	0	0	0
1	0	0	1	0	0	0	0	1	0	0

DIAGRAM 5

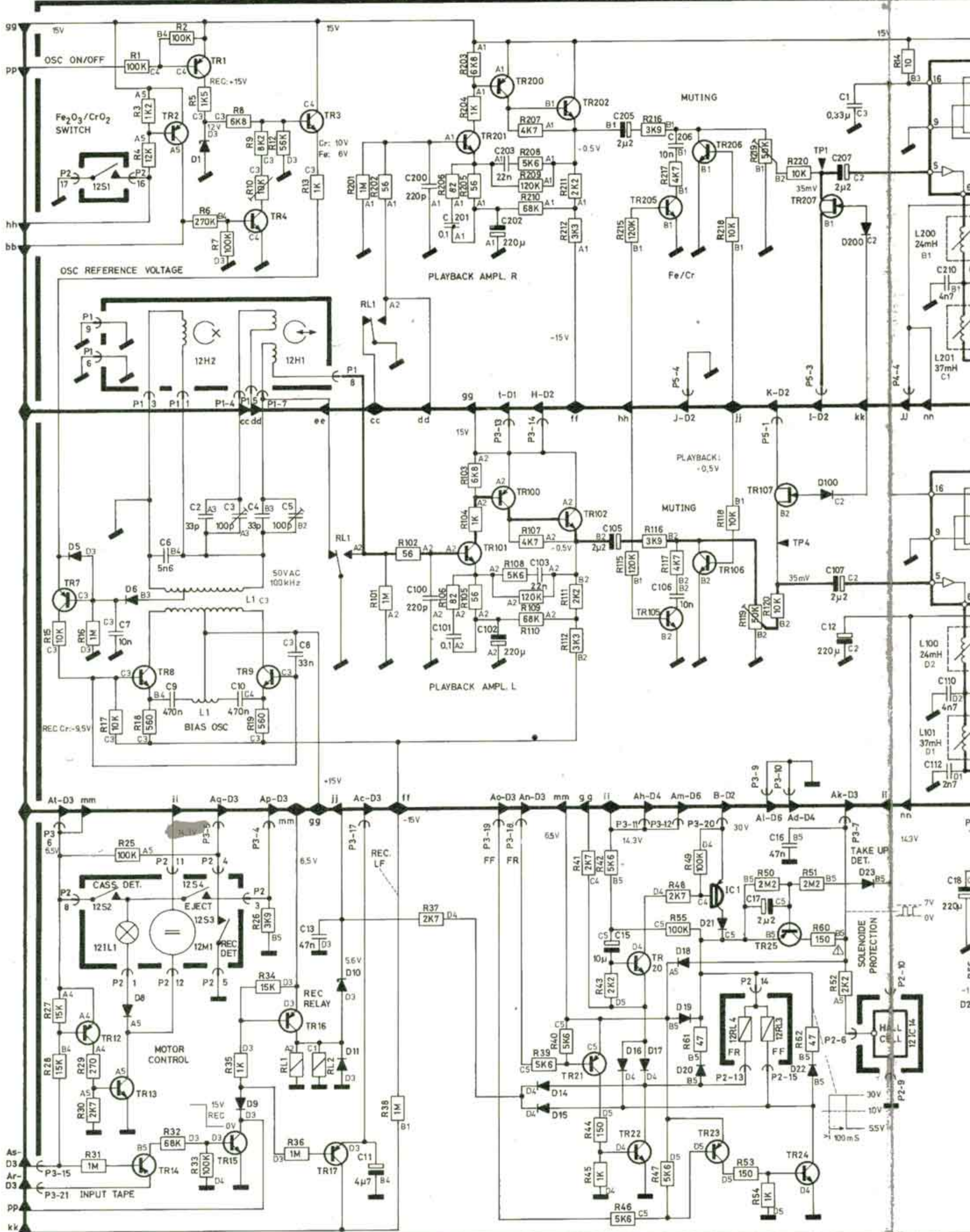

8004210 -11-

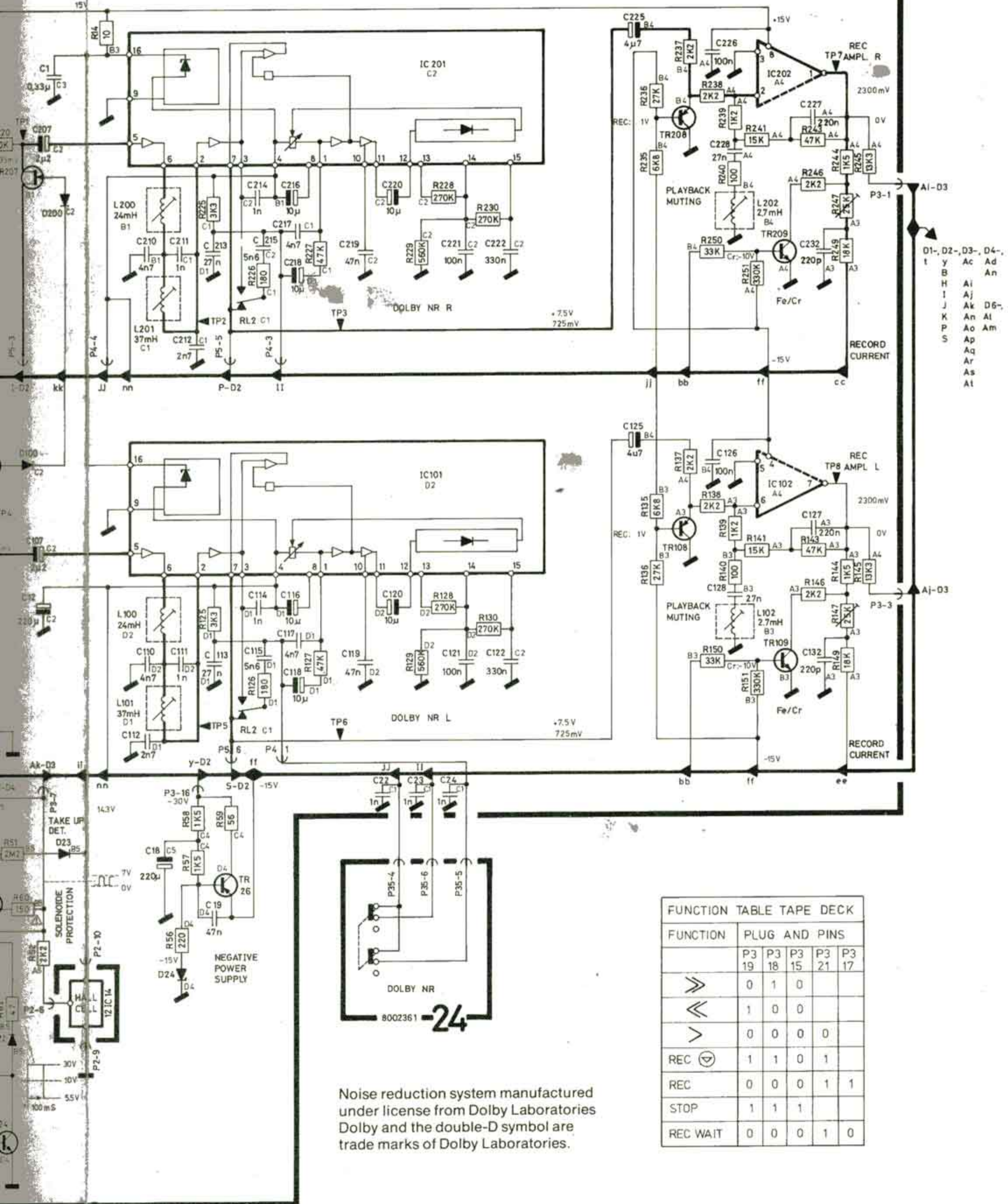

- D1-, D2-, D3-, D4-, t
- y B Ac Ad
- H Ai An
- I Aj D6-
- K Ak Al
- P An Am
- S Ap
- Aq
- Ar
- As
- At

FUNCTION TABLE TAPE DECK

FUNCTION	PLUG AND PINS
	P3 19 P3 18 P3 15 P3 21 P3 17
⏩	0 1 0
⏪	1 0 0
>	0 0 0 0
REC Ⓞ	1 1 0 1
REC	0 0 0 1 1
STOP	1 1 1
REC WAIT	0 0 0 1 0

Noise reduction system manufactured under license from Dolby Laboratories. Dolby and the double-D symbol are trade marks of Dolby Laboratories.

DIAGRAM 6

