

52



C/P

SERVICE MANUAL **2270**



**marantz**

model 2270

*Stereophonic Receiver*

**TABLE OF CONTENTS**

	<b>PAGE</b>
Introduction .....	1
Service Notes .....	1
AM Tuner .....	1
FM Tuner .....	2
Phono and Tone Amplifiers .....	4
Power Amplifier .....	4
Power Protection Circuit .....	5
Speaker Protection Relay Circuit .....	5
Suggestion for Trouble Shooting of Power Amplifier .....	5
Voltage Conversion .....	6
Test Equipment Required for Servicing .....	8
AM Alignment Procedure .....	9
FM Alignment Procedure .....	9
Stereo Separation Alignment .....	9
Muting Circuit Alignment .....	10
Audio Adjustment .....	10
Parts List .....	23
Specifications .....	33

**LIST OF ILLUSTRATIONS**

<b>FIGURE NO</b>	<b>PAGE</b>
1. Remove the Terminal Cover .....	6
2. Voltage Conversion Chart .....	7
3. Lissajou Figure on Oscilloscope .....	11
4. Dial Stringing .....	11
5. Front Panel Adjustment and Component Locations .....	12
6. Main Chassis Component Locations (Top View) .....	12
7. Rear Panel Adjustment and Component Locations .....	13
8. Main Chassis Component Locations (Bottom View) .....	13
9. FM Front End Assembly P100 Component Locations .....	14
10. FM IF Amplifier Assembly P200 Component Locations .....	14
11. FM Detector Assembly P500 Component Locations .....	15
12. MPX Stereo Decoding Amplifier Assembly P300 Component Locations .....	15
13. Muting Control Amplifier Assembly P550 Component Locations .....	16
14. AM Tuner Unit Assembly P150 Component Locations .....	16
15. Phono Amplifier Assembly P700 Component Locations .....	17
16. Tone Amplifier Assembly P400 Component Locations .....	17
17. Tone Control Unit Assembly P450 Component Locations .....	18
18. Power Amplifier Assembly P750 Component Locations .....	19
19. Regulated Power Supply and Protection Relay Circuit Assembly P800 Component Locations .....	20
20. Mono, High and Low Filter Switch Unit Assembly P600 Component Locations .....	21
21. Loudness, Muting and Speakers Switch Assembly P650 Component Locations .....	21
22. Schematic Diagram .....	22

## INTRODUCTION

This service manual was prepared for use by Authorized Warranty Stations and contains service information for Marantz Model 2270 Stereophonic Receiver.

Service information and voltage data included in this manual are intended for use by the knowledgeable and experienced technician only. All instructions should be read carefully. No attempt should be made to proceed without a good understanding of the operation in the receiver.

The parts list furnishes information by which replacement parts may be ordered from the Marantz Company. A simple description is included for parts which can usually be obtained through local suppliers.

### 1. Service Notes

As can be seen from the circuit diagram the chassis of Model 2270 consists of the following units. Each unit mounted on a printed circuit board is described within the square enclosed by a bold dotted line on the circuit diagram.

- |  |                            |
|--|----------------------------|
| 1. FM Front End.....   | mounted on P.C. Board P100 |
| 2. FM IF Amplifier.....                                      | mounted on P.C. Board P200 |
| 3. FM Detector.....  | mounted on P.C. Board P500 |
| 4. MPX Stereo Decoding Amplifier.....                        | mounted on P.C. Board P300 |
| 5. Muting Control Amplifier.....                             | mounted on P.C. Board P550 |
| 6. AM Tuner Unit.....  | mounted on P.C. Board P150 |
| 7. Phono Amplifier.....                                      | mounted on P.C. Board P700 |
| 8. Tone Amplifier.....                                       | mounted on P.C. Board P400 |
| 9. Tone Control Unit.....                                    | mounted on P.C. Board P450 |
| 10. Power Amplifier.....                                     | mounted on P.C. Board P750 |
| 11. Regulated Power Supply and Protection Relay Circuit..... | mounted on P.C. Board P800 |
| 12. Mono, High and Low Filter Switch unit.....               | mounted on P.C. Board P600 |
| 13. Loudness, Muting and Speakers Switch unit.....           | mounted on P.C. Board P650 |

### 2. AM Tuner

All components except Tuning capacitor and ferrite bar antenna are mounted on a printed circuit board P150.

The AM signals induced in a ferrite bar antenna are applied to the base of RF amplifier transistor H151 through a capacitor of C151 and amplified to the level required for overcoming the conversion noises, thus giving good S/N performance. The tuned circuits inserted in both out-and-in put circuit of the RF amplifier assure very high image and spurious rejection performance. Thus amplified and selected AM signals are then applied to the base of converter transistor H152 through a coupling capacitor C156. While the local oscillator voltage is injected to the emitter of H152 through a capacitor C157. Both AM signals and oscillating voltage are mixed at the base-emitter junction and converted into 455KHz intermediate frequency. The resulting IF signal is applied to the first IF transformer L153 consisting of one ceramic filter and two tuned circuits.

The output of L153 is led to the transistor H153 which in turn apply its output to the transistor of next stage H154. The fully amplified IF output is then applied to the diode H157 to detect audible signal through the detector transformer L154. The detected audio signal is filtered and amplified and the final audio output is obtained from the collector of H155 and applied: one to the tape out jacks through monitor switch on the front panel and the other to the function rotary switch.

The DC component of the detected IF signal is used as a AGC voltage to control emitter current of H153 which in turn control the bias current of the RF amplifier through the resistor R179 and R151. A part of IF signal output is also applied to the diode H158 through a capacitor C167 and rectified to obtain DC current for energizing the AM signal strength meter M001.

## 2.2 Suggestions for AM Tuner trouble shooting

Check for broken AM bar antenna, next try to tune station by rotating fly-wheel tuning knob slowly and observe the AM signal strength meter whether it deflects or not. If the signal strength meter gives a deflection at several frequencies received, no failure may exist in the stages at least preceding final IF transformer L154. Next connect a oscilloscope to the pin terminal J162 or J157 and check for audio signals with the tuning meter deflected. If the signal strength meter does not deflect, check the local oscillator circuit. Normal oscillating voltage at the hot end of the oscillator tuning capacitor is about 2 or 3 volts, varying with tuning capacitor position. When measuring oscillating voltage use a RF VTVM, no circuit tester gives correct indication. If the local oscillator voltage is normal, check all voltage distribution in the AM circuits by using a DC VTVM and compare the measured values with those given in the schematic diagram.

## 3. FM TUNER

The FM Tuner section of Model 2270 is divided into five functional blocks: FM Front End, IF Amplifier, Detector, Muting Control and MPX Stereo Decoding Circuit.

FM signals induced by a FM antenna are led to FM antenna coil L101 through an attenuator switch and a balun coil. These signals are then applied to the FET RF amplifier which in turn applies its output to the next FET Mixer H102 through the triple tuned high selective circuits. The FET Mixer convert its input signal into 10.7MHz intermediate frequency and amplifies it at the same time. The H103 is a local oscillator and its output is injected into the source of the FET Mixer, the injection voltage is about 700mV. The 10.7MHz front end output is led to the next IF amplifier unit through a coaxial cable.

The IF amplifier unit consists of six stages of IF amplifier, one stage of AGC amplifier and two stages of multipath signal amplifiers. Eight pieces of ceramic filters are also used to obtain high selectivity three stages of symmetrical diode limiters are also employed for the best limiting characteristics, improved capture ratio and good AM suppression.

A part of FM Front End output is applied to the AGC amplifier H207 and rectified its output is fed back to the gate of FET RF amplifier to decrease the gain with increased signal strength.

The signals required for multipath indication are obtained from the three stages of IF amplifiers through coupling capacitors C234, C236 and C238 respectively and rectified by three pair of full wave diode circuits. Thus obtained AM components of the FM signal is amplified by the transistor H208 and H209 and its output is again rectified to obtain DC current required for actuating the Multipath indication meter.

The IF signal sufficiently amplified through every stage of IF amplifier is finally applied to the IC limiter on the Detector Unit. The detected audio output is led to the buffer amplifier H502 and its buffered output is led to; (a) noise amplifier H551 through resistor R551 and capacitor C551, (b) Quad Radial Jacks on the rear panel through resistor R564, (c) MPX stereo decoding circuit through R563.

The DC current caused at the third windings of the discriminator transformer is directly applied to the FM center tuning meter.

### Audio Muting and Stereo mode auto-selecting circuit

The muting circuit consisting of all solid-state electrical switching has been incorporated in the Model 2270. Three inputs control the muting function. The first is related to signal strength, the second to the noise condition at the detector and the third is derived from the DC component of the detector output. These inputs are properly matrixed and gated to provide muting free from noise and transients.

The first input of DC voltage obtained by rectifying a part of IF output signal from the H206 is applied to the base of H306 and turns on it, if the IF output is greater than predetermined level (muting threshold level). When the H306 is turned on the H307 is turned off, allowing the emitter-collector resistance increasing and the collector voltage rises about 9.7V. The increased

collector voltage increases the gate bias voltage and turns on the switching FET H308, decreasing the source-drain resistance to near zero ohm and allowing the audio signal applied to the source to flow to the center of 38KHz switching transformer through the source-drain path.

When the input signal is lower than predetermined level, the DC output obtained is small and can not turn on the H306, thus the H306 keeps its turn-off state and this makes H307 turn on, decreasing the collector voltage and turning off H308. Thus no audio signals can pass through the FET. This is the fundamental principle of the muting operation but for more elaborate muting operation the second and the third inputs are necessary.

The second input is used to protect the muting operation and MPX stereo beacon lamps from misoperation due to undesirable noises. The high frequency noises included in the detected audio signals are separated by a small capacitor C551 and amplified by the noise amplifier transistor H551 and its output is rectified by the two diodes. The rectified DC output is proportional to the noise components in the audio signals.

When there are excessive noises in the audio signals such as obtained with a station incorrectly tuned in, the rectified DC output turns on the transistor H522, decreasing the emitter-collector resistance to zero. This means the collector of H307 is short-circuited to the ground, therefore the H308 is turned off and any audio signals having excessive high frequency noises can not go through the FET's sourcedrain path.

The transistor H303 connected in series with the 19KHz pilot signal amplifier transistor H302 is also turned off (when the transistor H522 or H307 are turned on.) and no current flows in the H302, resulting in turning off the stereo beacon lamps. Thus misoperation due to undesirable noises is also avoided.

The third input is obtained from the FM discriminator circuit. The DC output so called "S" curve is applied to the gate of H558 through a resistor R523 and dividing network (R565 & R566). The DC output is zero with a station correctly tuned in, but will vary from negative to positive values or vice versa when the tuning point is deviated toward either plus or minus frequency from the correct tuning frequency.

When the DC output is increased to a greater level than that of predetermined, the increased source potential of H558 makes the transistor H561 turn on, and this makes the H306 turn off,....H307 turn on, .... H308 turn off, .... H303 turn off (this means no 19KHz pilot signal is amplified and no stereo beacon is turned on.) When the DC output is increased to the negative predetermined level, the decreased source potential turns off the H559 which in turn makes the H560 turn on and the H306 is turned off. The subsequent changes are exactly the same as that just described above.

Thus when the tuning is shifted or deviated to the certain frequencies in which undesirable noisy side-audio signals are produced, both muting and 19KHz switching transistors are operated automatically and open the circuits.

With the station correctly tuned in, the bias current of the FET H558 is adjusted so that both transistor H560 and H561 are not turned on, giving no effect on the transistor H306.

### **MPX Stereo Decoding Circuit**

The buffered and non-equalized audio signals are applied to the first amplifier H301 which serve as a tuned amplifier for the pilot signal in the composite signals and as a buffer amplifier for the audio signals. The amplified 19KHz pilot signal is led to the second 19KHz amplifier H302 and further amplified if switching transistor H303 is turned on by the controlling DC signal as described in the preceding chapter. The final 19KHz pilot signal is rectified by the doubler circuit consisting of the H315 and H316 to obtain synchronized 38KHz amplifier driving signal.

The H304 is the 38KHz tuned amplifier and supplies its output to the switching matrix circuit consisting of four diodes. While the composite signals are applied to the center tap of switching transformer 1/2 L302. The right and left stereo signals decoded by the switching circuit are led to the crosstalk cancelling amplifier which utilizes complementary configuration with NPN and PNP

transistors through de-emphasis network consisting of C315 and R335, and C316 and R336. L305 is a low-pass filter networks having very sharp cut off characteristics and eliminates undesirable residual switching signals. Transistors H313 and H314 are buffer amplifiers and their outputs are led to the function switch.

### **3.2 Suggestion for Trouble Shooting of FM Tuner**

#### **3.2.1 Symptom: No FM Reception**

First turn on the power switch and try to tune FM stations. Rotate the fly-wheel tuning knob slowly and observe the FM signal strength meter and FM center tuning meter. If the center tuning meter deflect at several frequencies received, the tuner circuits preceding the discriminator circuit may have no failure. If the signal strength meter deflect but no deflection is obtained on the center meter, there may be some defects around the detecting circuit consisting H501, L501, H503, H504, etc. When no reading is obtained in both meters, check FM local oscillator circuit, using a RF VTVM. The normal local oscillator voltage is one or two volts (rms) at the tuning capacitor, depending on the tuning capacitor position. If the local oscillator voltage is normal, next check all voltage distribution in the FM Front End and IF amplifier unit and compare them with those shown in the circuit diagram. When both meters deflect but no sound is obtained, check audio circuits, using high sensitive oscilloscope.

#### **3.2.2 Symptom: No Stereo Separation**

First check the "MONO" switches are in normal out. position. Connect a FM RF signal generator output modulated by a stereo modulator to the rear FM antenna terminals, and check the stereo beacon is turned on or not. If not turned on, check for 19KHz pilot signal and 38KHz switching signal, using an oscilloscope.

### **4. Phono and Tone Amplifiers**

Program source signals from the PHONO jacks on the rear panel are supplied to the input circuit of the Phono Amplifier through the selector switch and the output of the Phono Amplifier is applied to another section of the selector switch. This amplifier provides a gain of 40dB.

All signals selected by the function switch (S002-3F, 4F) are led to the balance and volume controls through the MONO(L,R) and Hi-Blend switches.

Signals properly attenuated by the volume control are applied to the tone amplifier and subjected to the tone control networks such as bass, mid, treble control and high and low cut filters.

Thus controlled audio signals are then led to the PRE OUT jacks on the rear panel.

### **5. Power Amplifier**

The signal from the tone amplifier is applied to the differential amplifier (base of H751) through the coupling capacitor C751. The differential amplifier provides very high input impedance and its collector output (H752) is applied to the base of H753 which in turn applies its output to the next stage; to the H756 through the network R766, C762 and R771, and to the H757 through the network R776, C763 and R772. The outputs of H756 and H757 are applied to the H758 and H757 respectively. H001 and H002 are power transistors used in complementary symmetry configuration and mounted on the heat sink.

To maintain overall amplifier stability and linearity, degenerative feed back is utilized throughout the amplifier. This feed back is also necessary to reduce distortion to within specified limit. The RC network R775 and C756 condition the feed back signal for the audio signals. R759 and C755 are also a feed back loop provided to obtain a stable zero DC off set voltage at the speaker output terminals. The R762 is a trimming resistor to adjust the DC offset voltage.

Dynamic bias is applied to the base of driver transistors H758 and H757. This dynamic bias circuit is comprised of H761, H760 and R763. This provides a variable base bias for driver

transistors that automatically maintains the proper base voltage with temperature change. The temperature sensitive biasing components of the dynamic circuit are thermally coupled through a heatsink to the power amplifier transistors.

#### **6. Power Protection Circuit**

Protection circuit for the amplifier is provided by sensing resistor networks and two switching transistors. When the output transistors are over-driven, the current increase through the power output transistor causes an increased current flow through R789 (or R788) and the potential across the R789 will be increased. This increased voltage potential is applied to the base of H755 through the resistor R783 and turns on the H755. Since the collector of H755 is directly connected to the base of H757, this means that the base of H757 is by-passed to the ground through emitter-collector path of H755. Thus the input signal to the H757 is restricted to the value which maintains the operation of power transistor within the safety area. A resistor network R777 and R781 also works as a sensing network. When the center voltage (collector voltage of power transistors) is excessively increased to a positive value by certain troubles, the voltage applied to the base of H755 makes the H755 turn on, making bypass circuit, and protects the power transistor. For the other half cycle of driving signal, the same operating principle is applied provided.

#### **7. Speaker Protector Relay circuit**

The speaker protection circuit, consisting of H808, H809, H810, etc protects the speaker systems against any loud "pop" sound developed. This circuit is so designed that no sound is heard for the first three or five seconds after the power switch is turned on by the time constant circuit consisting of C807 and R816. This circuit also protects the speaker systems against some troubles due to DC off balance between the speaker system terminals by instantly operating the relay and cut off the speaker systems from the circuit. When DC off balance voltage (positive) is developed between speaker terminals by possible defects such as broken power transistor, short-circuits, or broken potentiometer R762, as the base of H808 is connected to the speaker terminal, the transistor H808 is turned on by this offset voltage developed and this makes the transistor H809 and H810 turn off, thus cutting off the relay and disconnecting the speaker from the output circuit. When negative offset voltage is developed, this voltage directly turns off the H809 and H810, thus speaker is cut off from the circuit and protected.

The circuit also protects the speaker systems from the possible damage when the amplifier is over-driven by very low frequencies such as 7 or lower cycles.

#### **8. Suggestions for Trouble Shooting of Power Amplifier**

##### **8.1 Excessive line consumption**

- a. Check for shorted rectifiers H005; also check C007 and C008.
- b. Check for shorted transistors H758 and H759, H001 and H002, or check H760. Check for open control R763, and bias diode H761. Check L004 for short.

**CAUTION: BECAUSE THE DRIVER AND OUTPUT STAGES ARE DIRECT COUPLED COMPONENTS MAY FAIL AS A DIRECT RESULT OF AN INITIAL COMPONENT FAILURE. IF A SHORTED TRANSISTOR OR ZENER DIODE IS FOUND, OR CONTROL OR BIAS DIODE, BE SURE TO CHECK THE REMAINING DRIVER AND OUTPUT COMPONENTS FOR SHORT OR OPEN CIRCUIT BEFORE RE-ENERGIZING THE AMPLIFIER.**

##### **8.2 No Line Consumption or Zero Bias**

- a. Check line cord, fuse, transistors H760, H001, H002, H003 and H004, bias diode H761.
- b. Check for open rectifier H005, or open L004.

**8.3 No DC Balance**

- a. Check R762 and Zener diodes H762 and H763.

**9. Voltage Conversion**

This model is equipped with a universal power transformer to permit operation at 100, 120, 220 and 240 V AC 50 to 60Hz.

To convert the Model 2270 to the required voltage perform the following steps:

- (1) Remove the top cover.
- (2) Remove the Transformer Wire Connection Terminal Cover, loosen two Cover mounting screws on the rear panel, see Fig. 1
- (3) Change the jumper wires as illustrated in Fig. 2 for the required AC voltage and replace the fuse as instructed.

**CAUTION: DISCONNECT POWER SUPPLY CORD FROM AC OUTLET BEFORE CONVERTING VOLTAGE.**

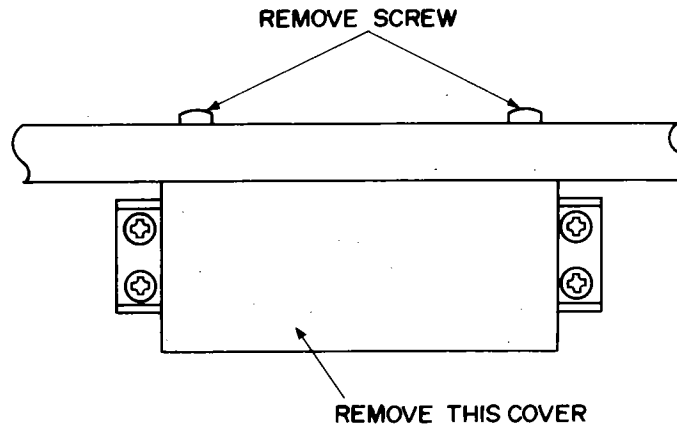

Figure 1 Remove the Terminal Cover



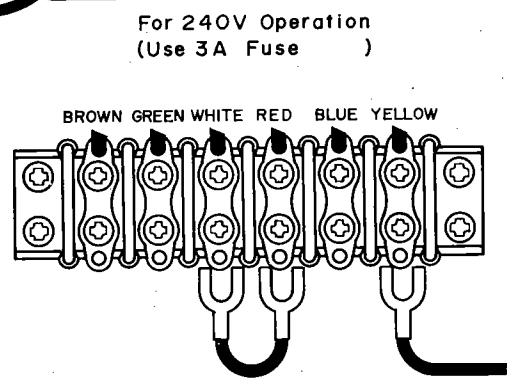
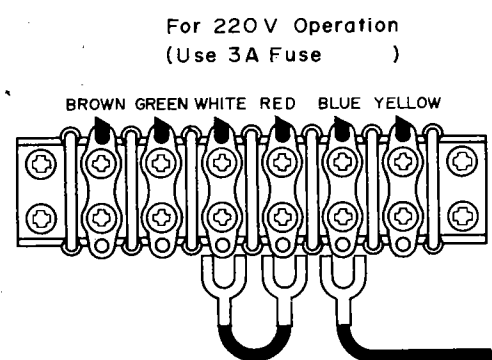
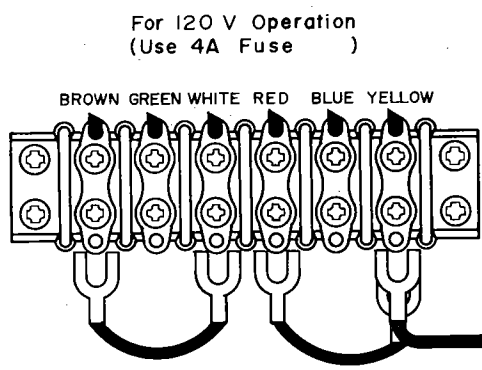
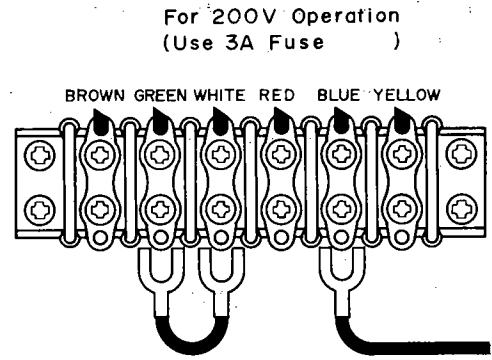
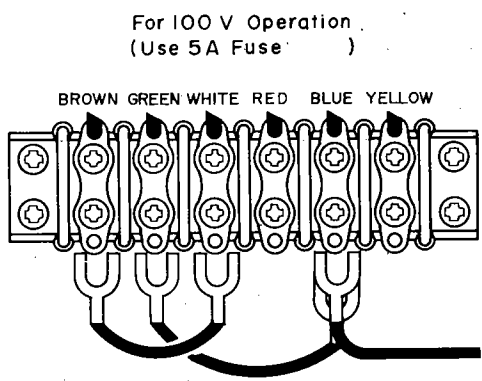

Figure 2 Voltage Conversion Chart

**10. Test Equipment Required for Servicing**

Table 1 lists the test equipment required for servicing the Model 2270 Receiver.

Item	Manufacturer and Model No.	Use
AM Signal Generator		Signal source for AM alignment
Test Loop		Used with AM Signal generator
FM Signal Generator	Less than 0.3% distortion	Signal source for FM alignment
Stereo Modulator	Less than 0.3% distortion	Stereo separation alignment and trouble shooting
Audio Oscillator	Weston Model CVO-100P, less than 0.02% residual distortion is required.	Sinewave and squarewave signal source.
Oscilloscope	High sensitivity with DC horizontal and vertical amplifiers.	Waveform analysis and trouble shooting, and ASO alignment.
VTVM	With AC, DC, RF range	Voltage measurements.
Circuit Tester		Trouble Shooting
AC Wattmeter	Simpson, Model 390	Monitors primary power to Amplifier.
AC Ammeter	Commercial Grade (1-10A)	Monitors amplifier output under short circuit condition.
Line Voltmeter	Commercial Grade (0-150VAC)	Monitors potential of primary power to amplifier.
Variable Autotransformer (0-140VAC, 10 amps.)	Powerstat, Model 116B	Adjusts level of primary power to amplifier.
Shorting Plug	Use phono plug with 600 ohm across center pin and shell.	Shorts amplifier input to eliminate noise pickup.
Output Load (8 ohms, 0.5%, 100W)	Commercial Grade	Provides 8-ohm load for amplifier output termination.
Output Load (4 ohms, 0.5%, 100W)	Commercial Grade	Provides 4-ohm load for amplifier output termination.

## 11 AM Alignment Procedure

### AM IF Alignment

1. Connect a sweep generator to the J151 and an alignment scope to the J162.
2. Rotate each core of IF transformer L153 and L154 for maximum height and flat top symmetrical response.

### AM Frequency Range and Tracking Alignment

1. Set AM signal generator to 525 KHz. Turn the tuning capacitor fully closed (place the tuning pointer at the low end.) and adjust the oscillator coil L152 for maximum audio output.
2. Set the signal generator to 1650 KHz. Place the tuning pointer in the high frequency end and adjust the oscillator trimmer on the oscillator tuning capacitor for maximum audio output.
3. Repeat the Step 1 and 2 until no further adjustment is necessary.
4. Set the generator to 600 KHz and tune the receiver to the same frequency and adjust a slug core of AM ferrite rod antenna and RF coil L151 for maximum output.
5. Set the generator to 1400 KHz and tune the receiver to the same frequency and adjust both trimming capacitors of Antenna and RF tuned circuit for maximum output.
6. Repeat the step 4 and 5 until no further adjustment is necessary.

Note: During tracking alignment reduce the signal generator output as necessary to avoid AGC action.

## 12 FM Alignment Procedure

1. Connect a FM signal generator to the FM antenna terminals and a oscilloscope and an audio distortion analyzer to the tape output jacks on the rear panel.
2. Set the FM SG to 87.5 MHz and provide about 3 to 5  $\mu\text{V}$ . Place the tuning pointer at the low frequency end by rotating the tuning knob and adjust the core of oscillator coil L105 to obtain maximum audio output.
3. Set the FM SG to 108.5 MHz and provide about 3 to 5  $\mu\text{V}$  output. Rotate the tuning knob and place the tuning pointer at the high frequency end and adjust the trimming capacitor C106 for maximum output.
4. Repeat the step 2 and 3 until no further adjustment is necessary.
5. Set the FM SG to 90 MHz and tune the receiver to the same frequency. Decrease signal generator output until the audio output level decreases with the decreasing generator output. Adjust the antenna coil L101, RF coil L102, L103 and L104 and IF transformer L106 for minimum audio distortion.
6. Set the FM SG to 106 MHz and tune the receiver to the same frequency. Adjust the trimming capacitor C102, C103, C104 and C105 for minimum distortion.
7. Adjust the secondary core (black) of discriminator transformer L501 so that the center tuning meter pointer indicates its center at no signal applied. Set the FM SG to 98 MHz and increase its output level to 1K $\mu\text{V}$  and tune the receiver to the same frequency so that the center tuning meter pointer indicates its center. Adjust the primary core (pink) of L501 for minimum distortion.

## 13 STEREO Separation Alignment

1. Set the FM SG to provide 1  $\mu\text{V}$  at 98 MHz. Tune the receiver to the same frequency so that the center tuning meter pointer indicates its center.
2. Modulate the FM SG with stereo composite signal consisting of only subchannel signal (of course a pilot signal must be included). Adjust the core of L301 for maximum audio output, then, modulate the signal generator with a stereo composite signal consisting of only L channel signal and again adjust the core of L301 for maximum audio output.
3. Adjust the trimming resistor R365 for maximum and same separation in both channels.

#### 14. Muting Circuit Alignment

1. Connect a VTVM across the resistor R022 and adjust the resistor R022 until the meter reads 0.75 V DC at no signal.
2. Set the FM SG to provide 1 K $\mu$ V at 98 MHz and tune the receiver to the same frequency correctly.
3. Turn on MUTING pushswitch. Shift the FM signal generator frequency to plus and minus and note both plus and minus shifted frequencies at which undesirable audio side responses are muted out. Adjust the R022 so that the same shifted frequencies mute the undesirable side response.

#### 15 Audio Adjustment

1. Voltage adjustment  
Connect a DC voltmeter between pin terminal J802 and J803, and adjust the trimming resistor R809 for 35V DC.
2. Main Amplifier DC off-set alignment  
Connect a DC voltmeter with 0.5 or 1 V range between the speaker terminals and adjust the trimming resistor R762 for "zero" DC output on the meter.  
Repeat the same procedure for the other channel.  
Note: During this alignment no load should be connected to the speaker terminals.
3. Idle-current adjustment  
Connect a VTVM between pin terminals J753 and J754. Next, rotate the trimming resistor R763 fully counterclockwise, then rotate it clockwise again until the VTVM reads 5 mV DC.  
Repeat the same procedure for the other channel.  
Note: During this alignment no load should be connected to the speaker terminals.
4. Check DC off-set voltage aligned in the procedure 2 and if any DC output is observed on the DC voltmeter, adjust the R762 again for "zero" output.
5. Phono-amplifier adjustment  
Connect a oscilloscope to the TAPE OUT jacks and an audio signal generator to the PHONO jacks. Place the selector switch in the PHONO position. Increase 1 KHz audio signal gradually until a slight clipping on top of the sine-wave is observed on the oscilloscope. Adjust the trimming resistor R708 for equal clipping level.  
For the other channel adjust R709.
6. Main Amplifier ASO adjustment  
For this alignment two DC oscilloscopes are necessary.
  - 6.1 First, make calibration on each oscilloscope gain for;  
Vertical Sensitivity 0.2 V/cm  
Horizontal Sensitivity 10 V/cm
  - 6.2 Connect pin J753 to the scope vertical input terminal. Connect pin J754 to the scope ground terminal. Connect pin J756 to the scope horizontal input terminal. Adjust the horizontal and vertical position knobs so that a "spot" on the scope is placed on the lower right corner.
  - 6.3 Connect pin J760 to the scope vertical input terminal. Connect pin J761 to the scope ground terminal. Connect pin J756 to the scope horizontal input terminal. Adjust the horizontal and vertical position knobs so that a "spot" on the scope is placed on the lower left corner.
  - 6.4 Remove two jumper plugs connected between the PRE OUT and MAIN IN jacks on the rear panel. Connect a low-loss oil paper capacitor of 6 $\mu$ F (or equivalent) to the speaker terminals being adjusted.
  - 6.5 Connect an audio signal generator to the MAIN IN jack. Increase the audio signal (1 KHz) input level until the Lissajou Figures as shown below are obtained on the scopes. Adjust the trimming resistors R782 and R783 for the height of 2.0cm.
  - 6.6 Change the audio input frequency from 1 KHz to 20 Hz and check whether the speaker

protection relay has been operated or not. (When the relay has been operated, no signal is provided to the speaker terminals.) If there is no signal at the speaker terminals, turn off the system power of the amplifier for about one minutes, then again turn on the power and adjust the R782 and R783 for a slight increased height of A and B.

6.7 For the another Main Amplifier, repeat the procedures 6.2 to 6.6.

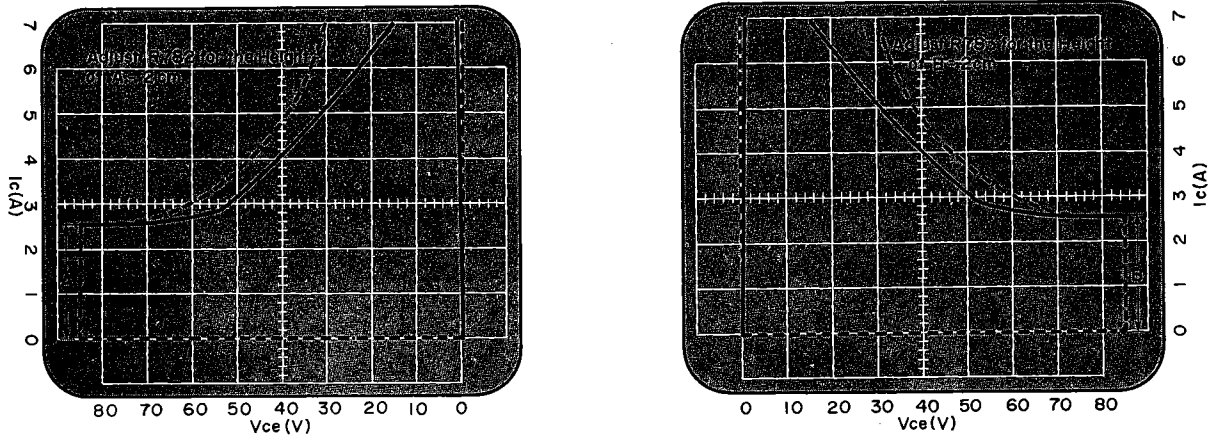

Figure 3 Lissajou Figure on Oscilloscope

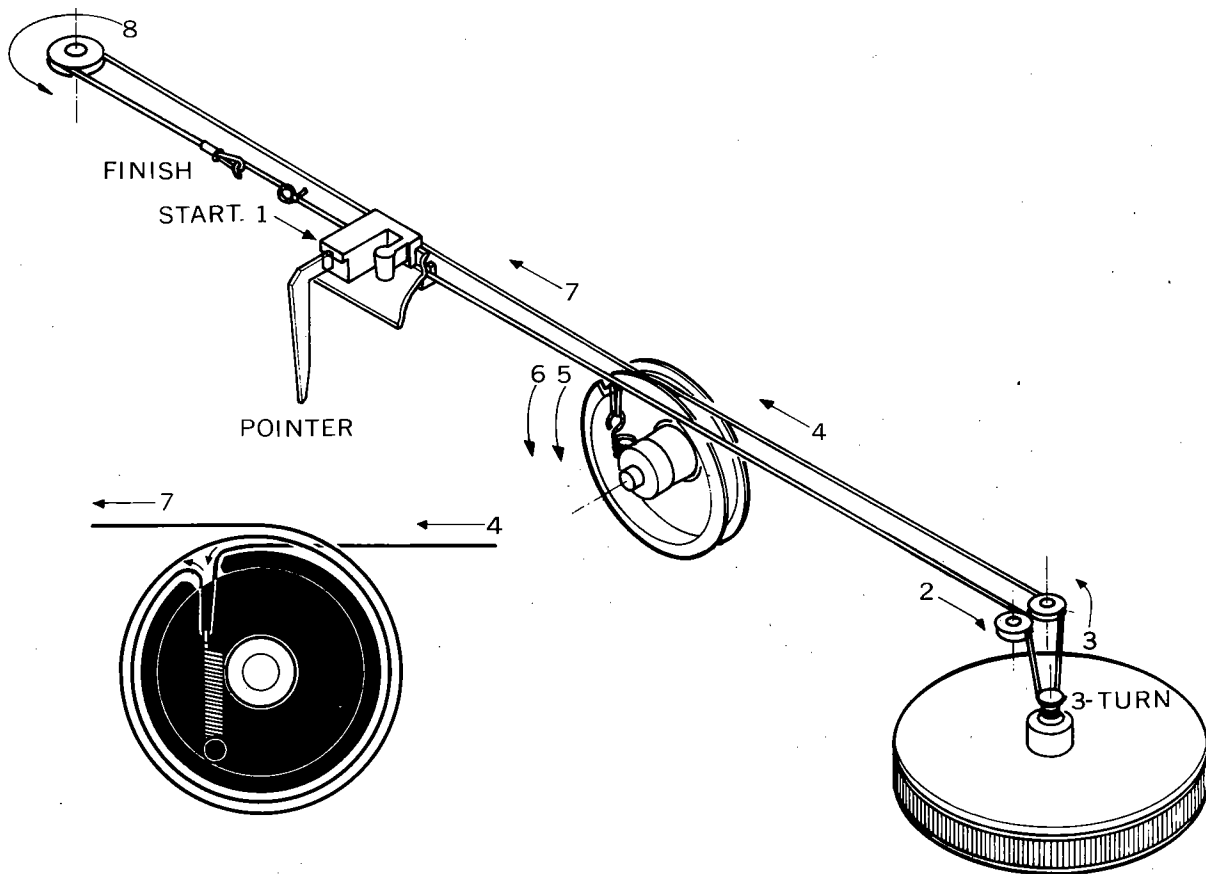

Figure 4 Dial Stringing

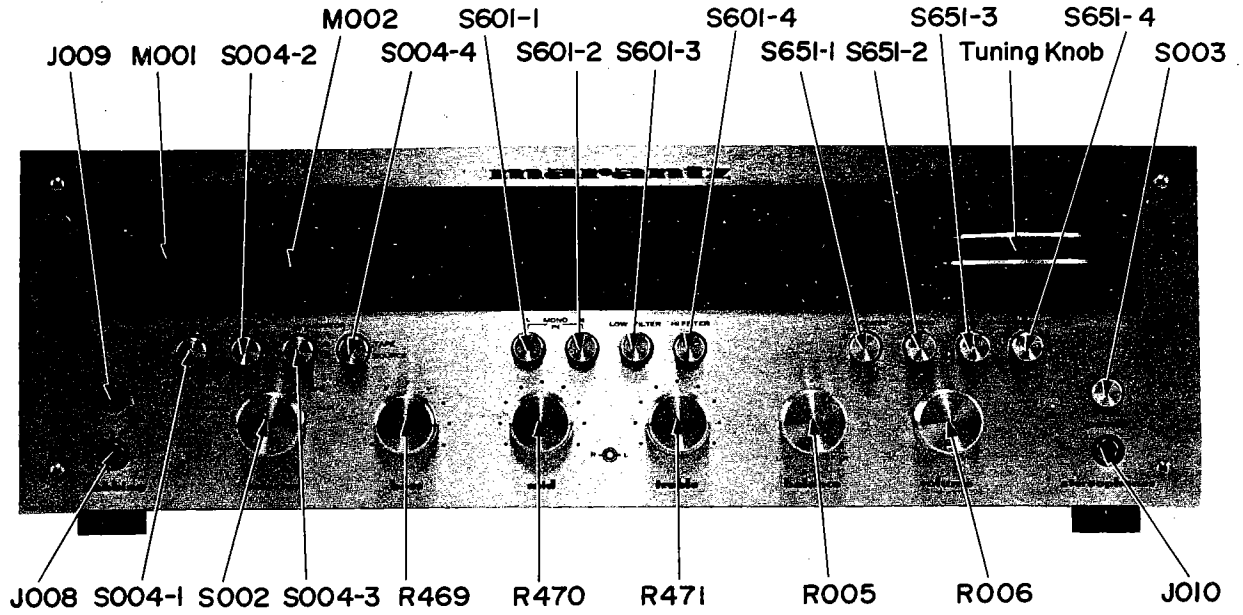

Figure 5 Front Panel Adjustment and Component Locations

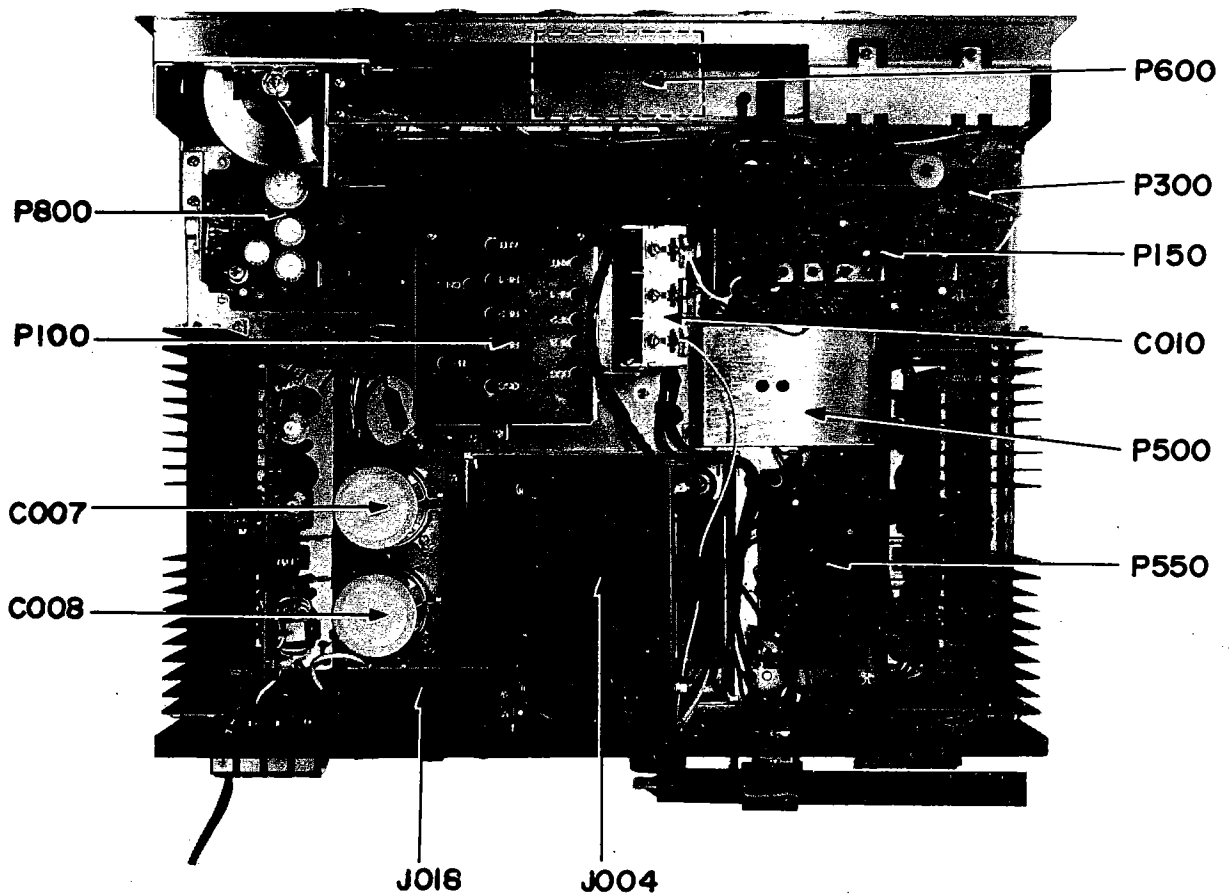

Figure 6 Main Chassis Component Locations (Top View)

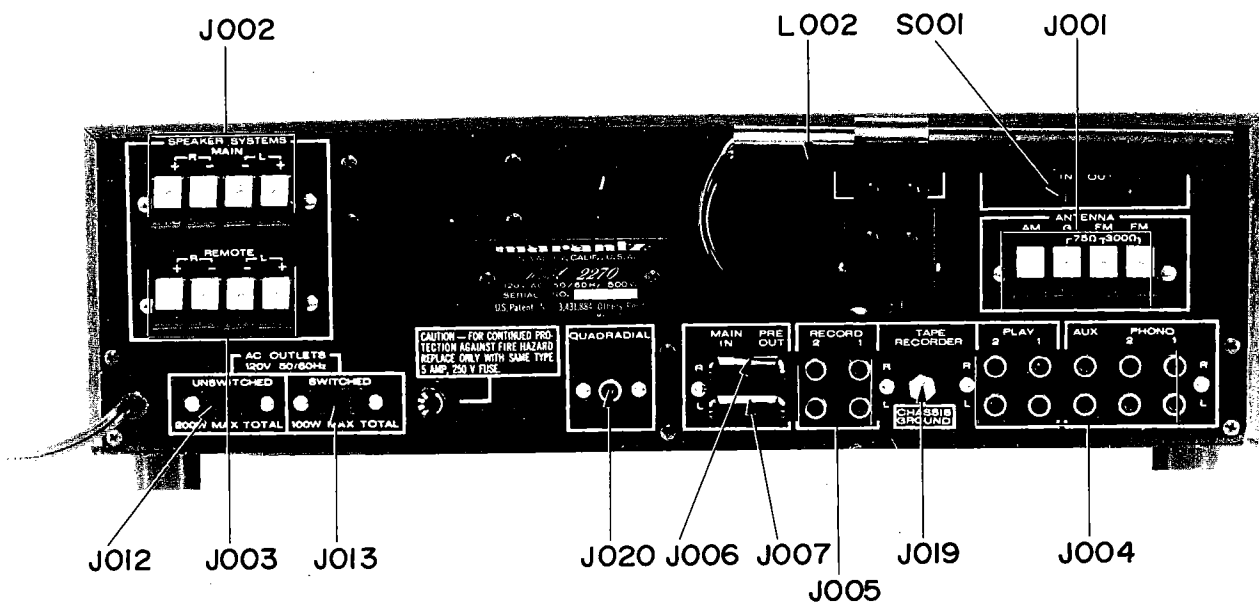

Figure 7 Rear Panel Adjustment and Component Locations

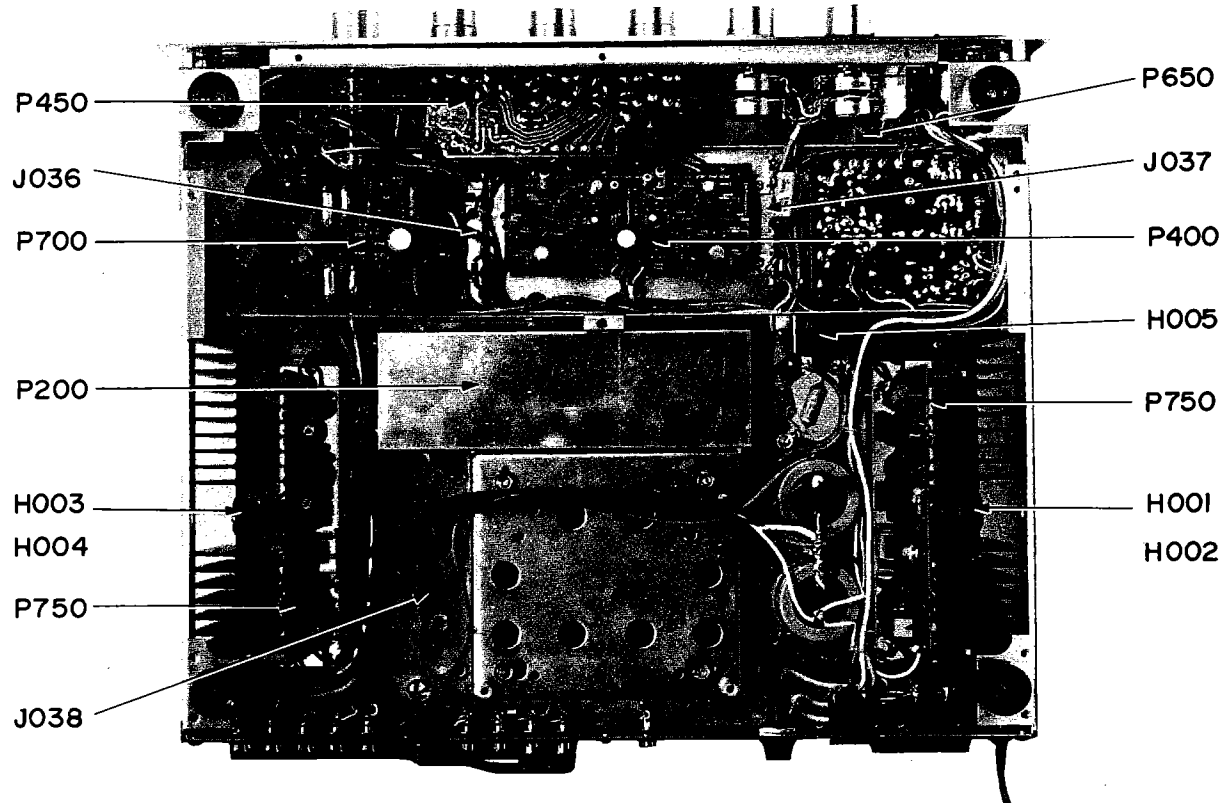

Figure 8 Main Chassis Component Locations (Bottom View)

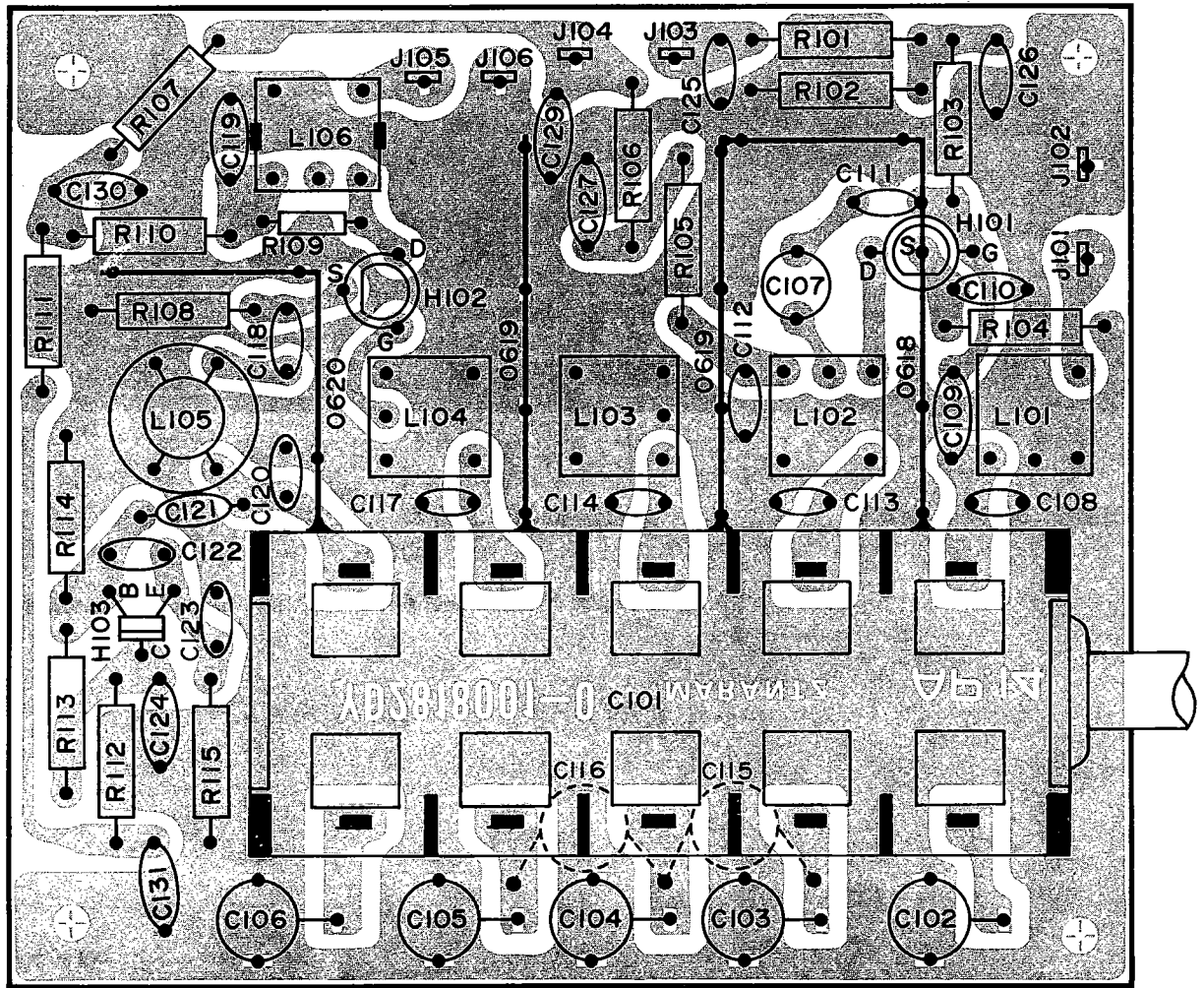

Figure 9 FM Front End Assembly P100 Component Locations

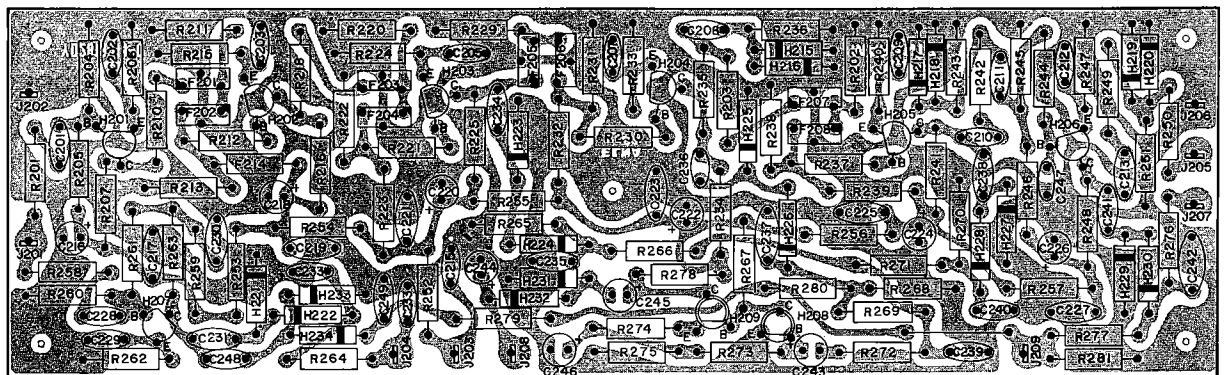

Figure 10 FM IF Amplifier Assembly P200 Component Locations



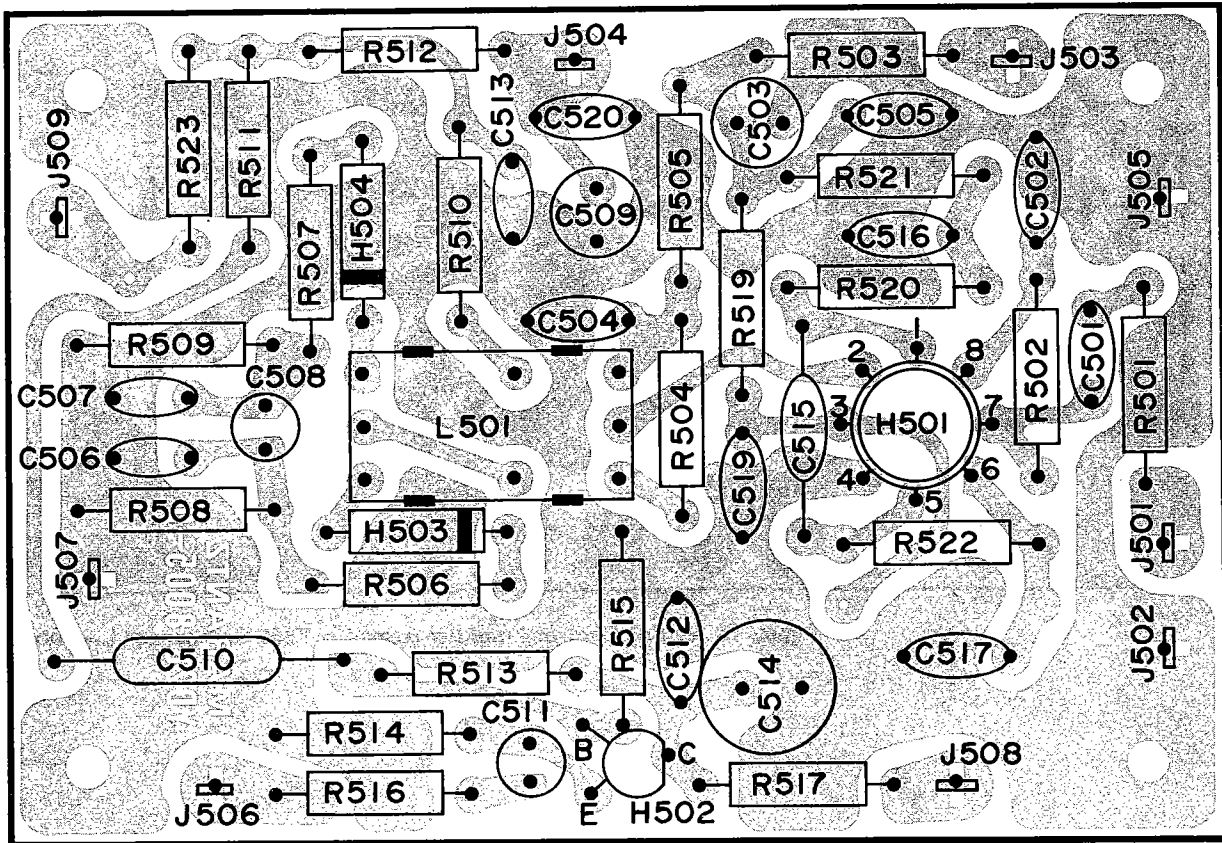

Figure 11 FM Detector Assembly P500 Component Locations

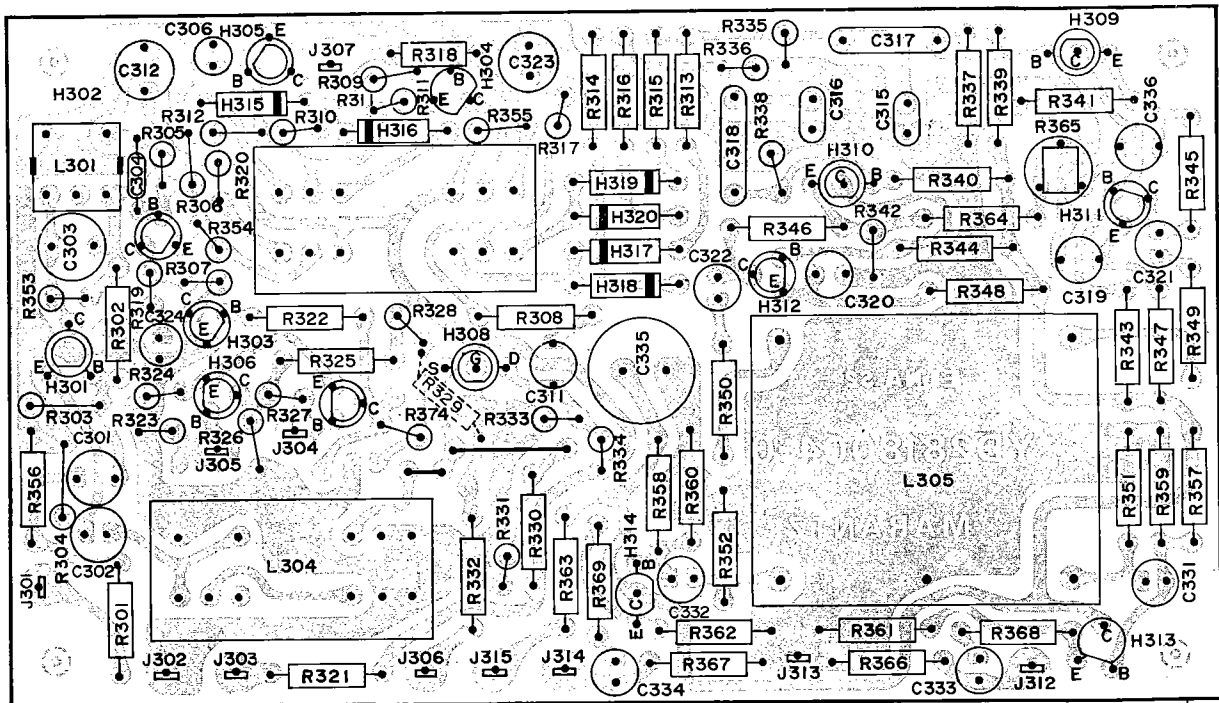

Figure 12 MPX Stereo Decoding Amplifier Assembly P300 Component Locations

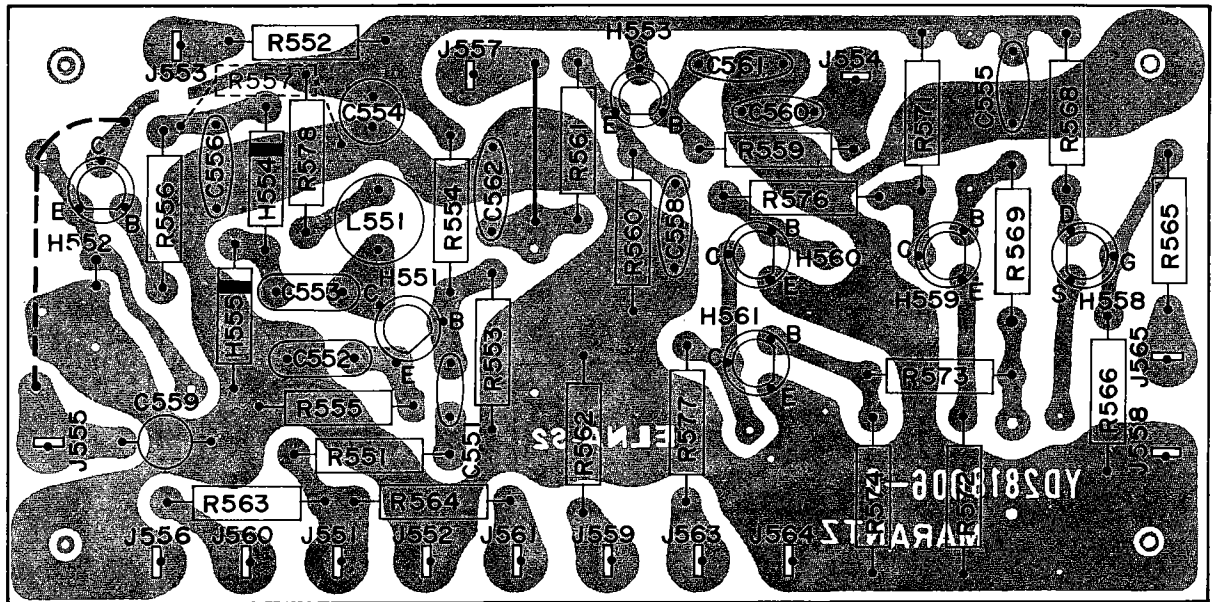

Figure 13 Muting Control Amplifier Assembly P550 Component Locations

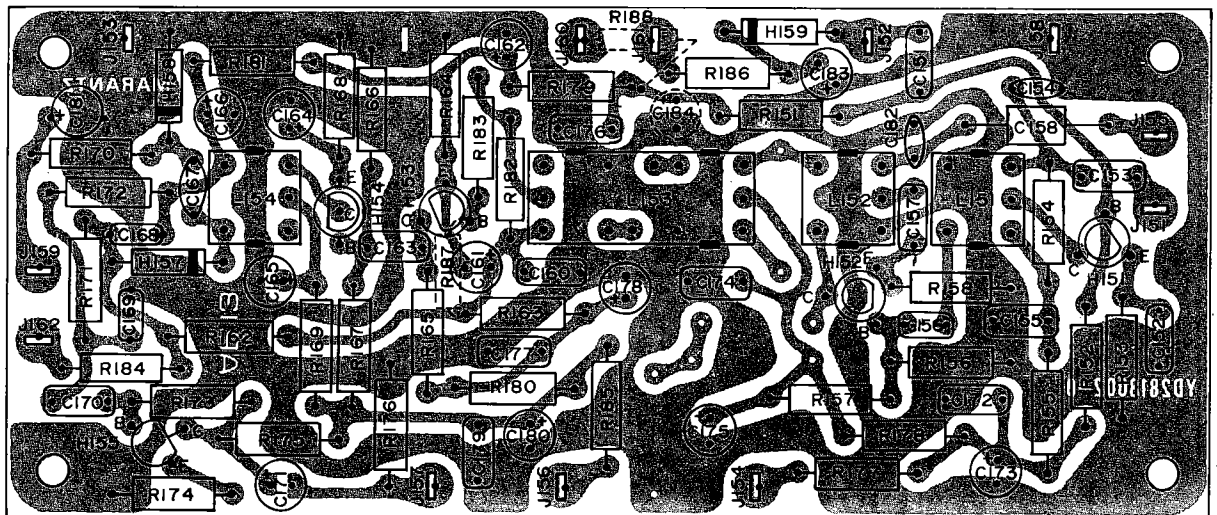

Figure 14 AM Tuner Unit Assembly P150 Component Locations

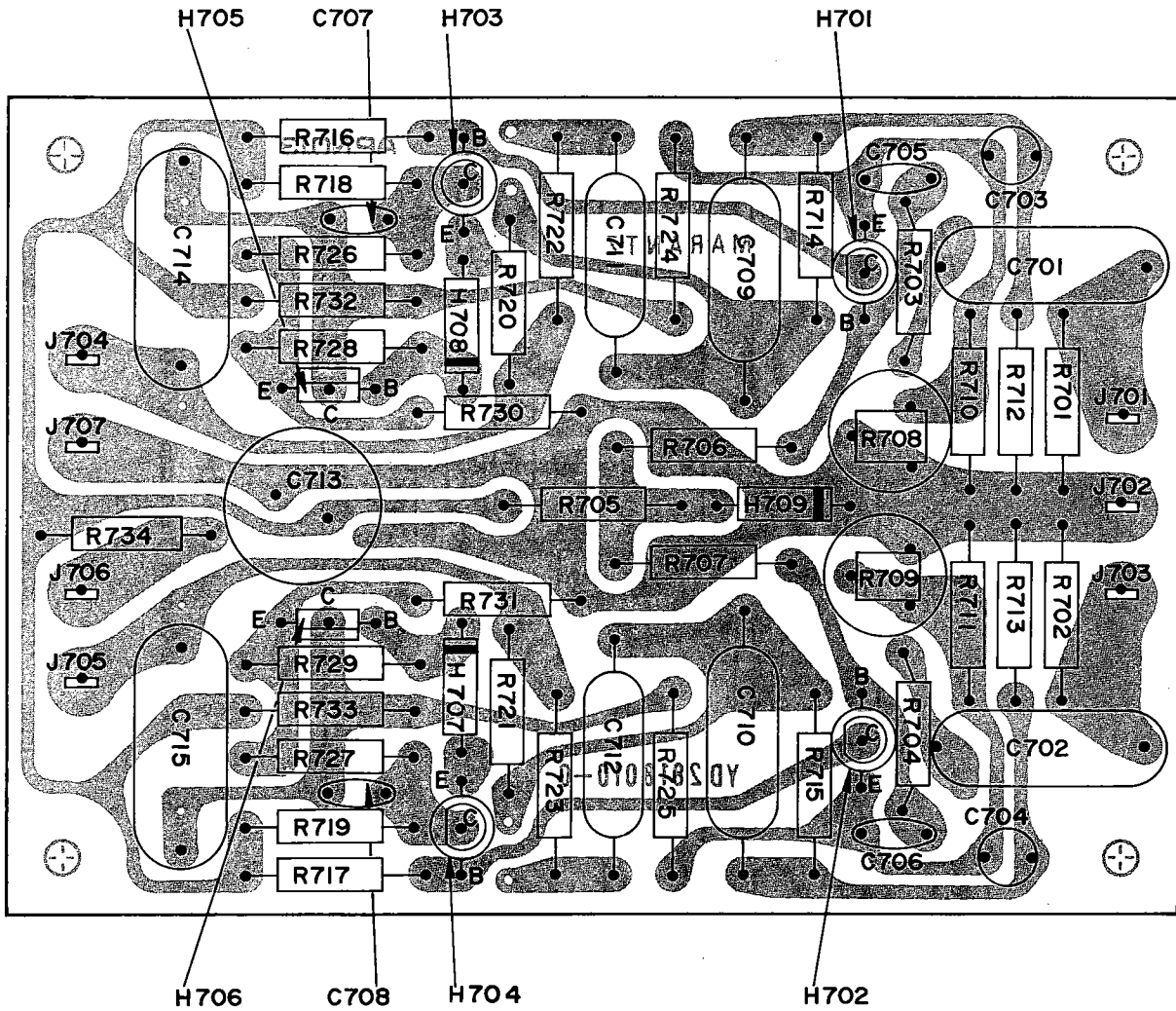

Figure 15 Phono Amplifier Assembly P700 Component Locations

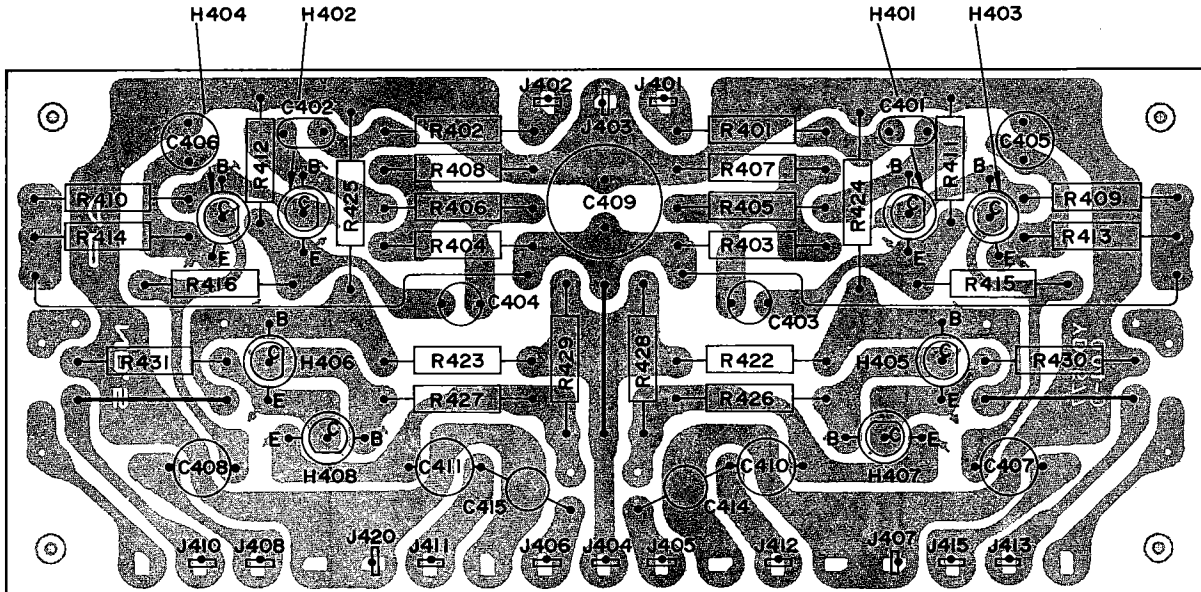

Figure 16 Tone Amplifier Assembly P400 Component Locations

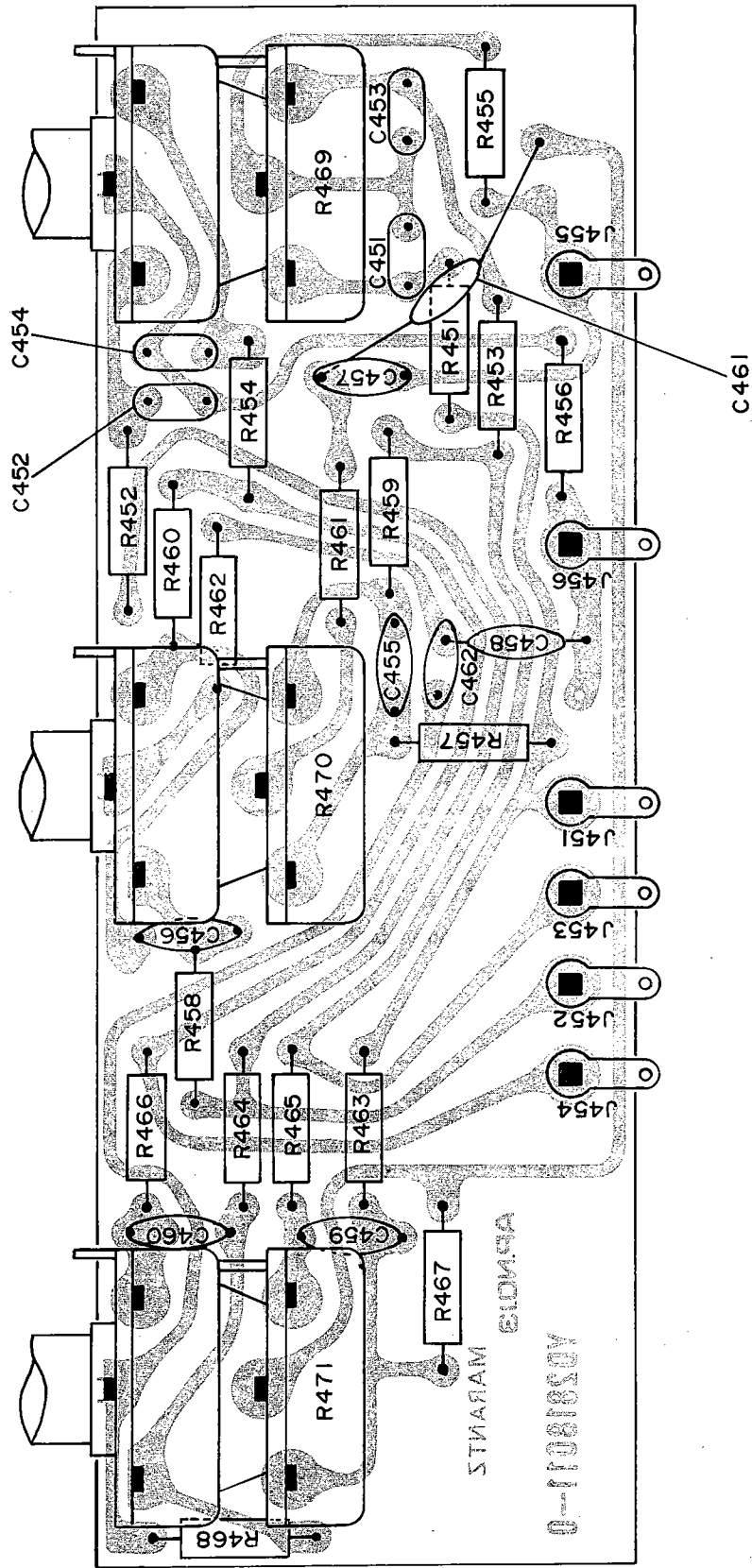

Figure 17 Tone Control Unit Assembly P450 Component Locations



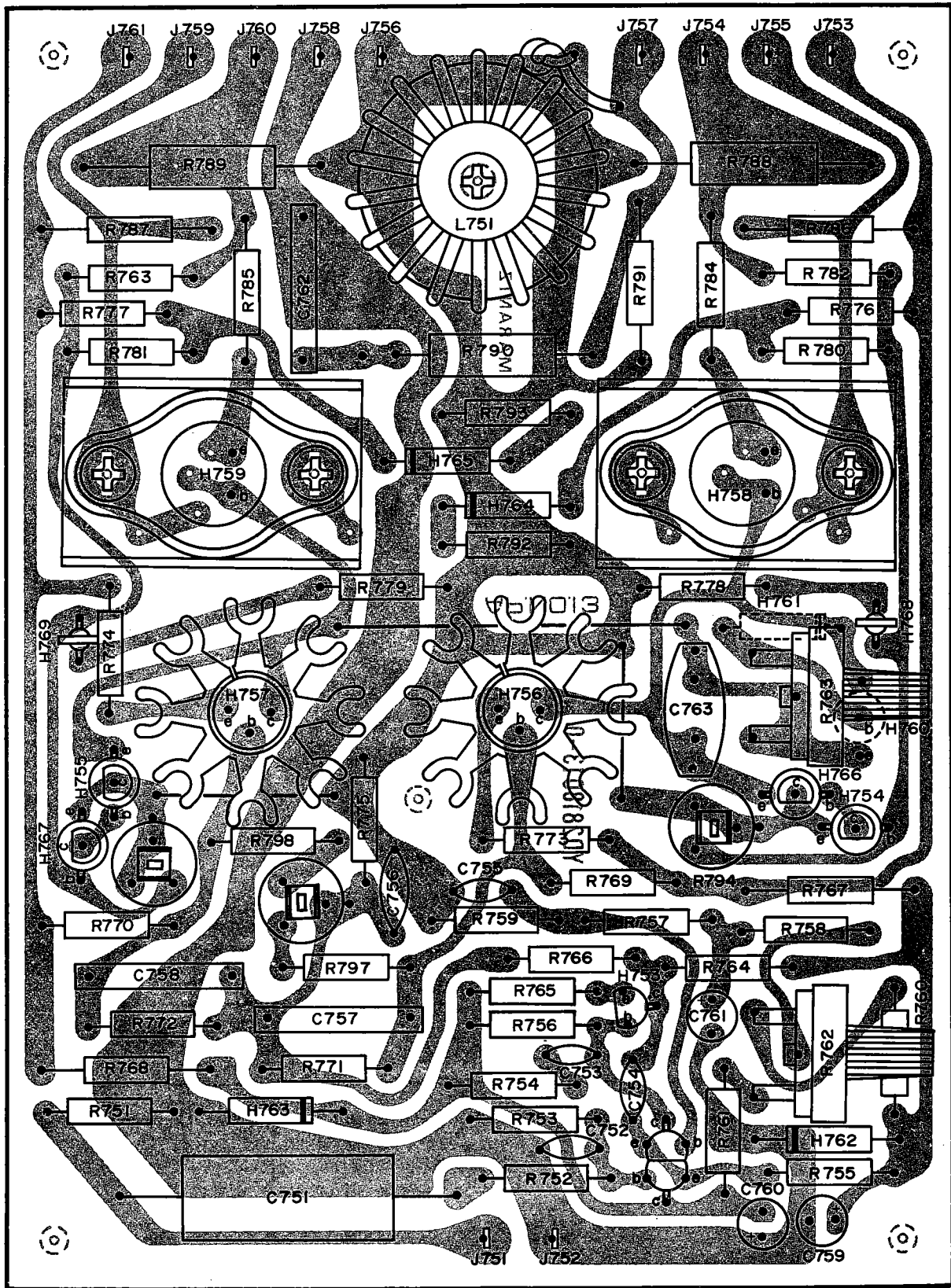

Figure 18 Power Amplifier Assembly P750 Component Locations

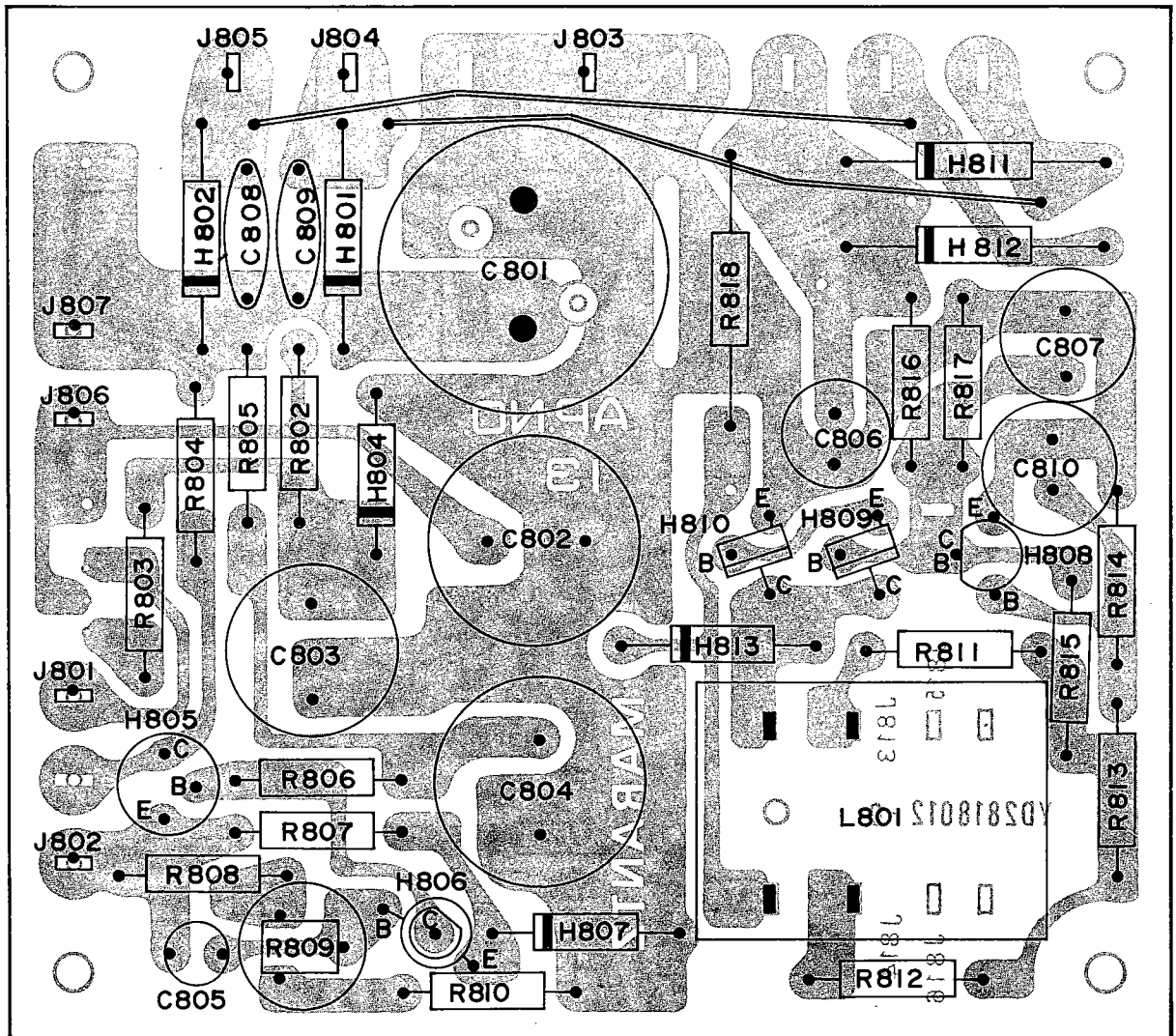

Figure 19 Regulated Power Supply and Protection Relay Circuit Assembly P800 Component Locations

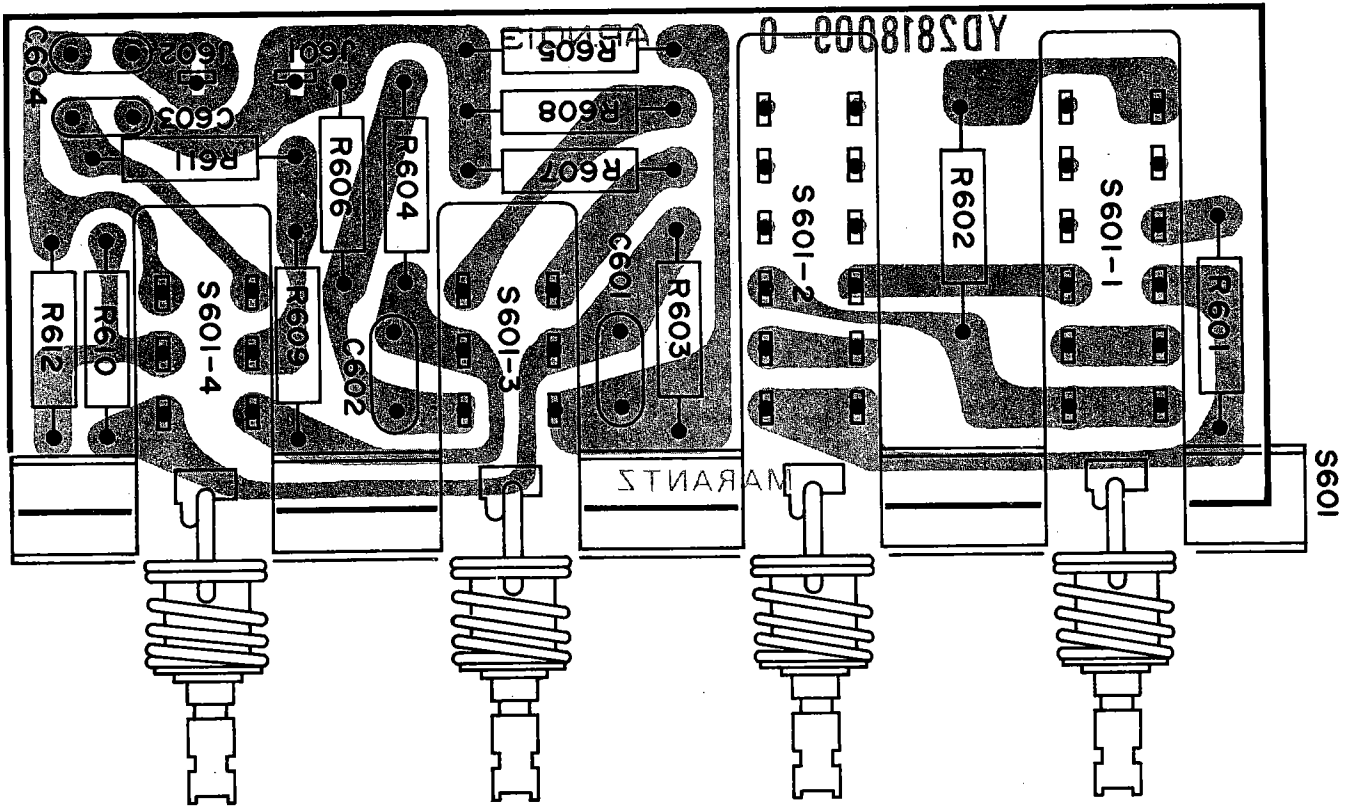

Figure 20 Mono, High and Low Filter Switch Unit Assembly P600 Component Locations

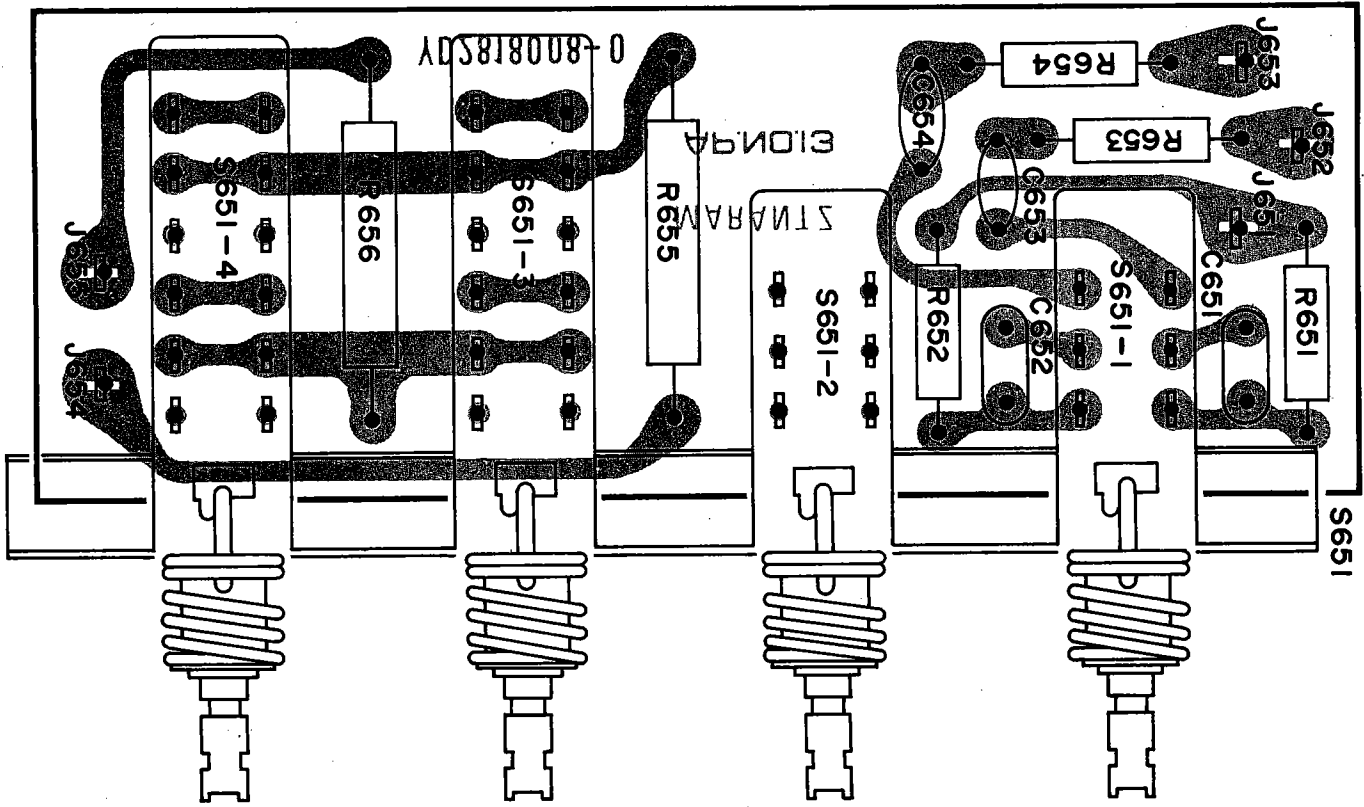

Figure 21 Loudness, Muting and Speakers Switch Assembly P650 Component Locations

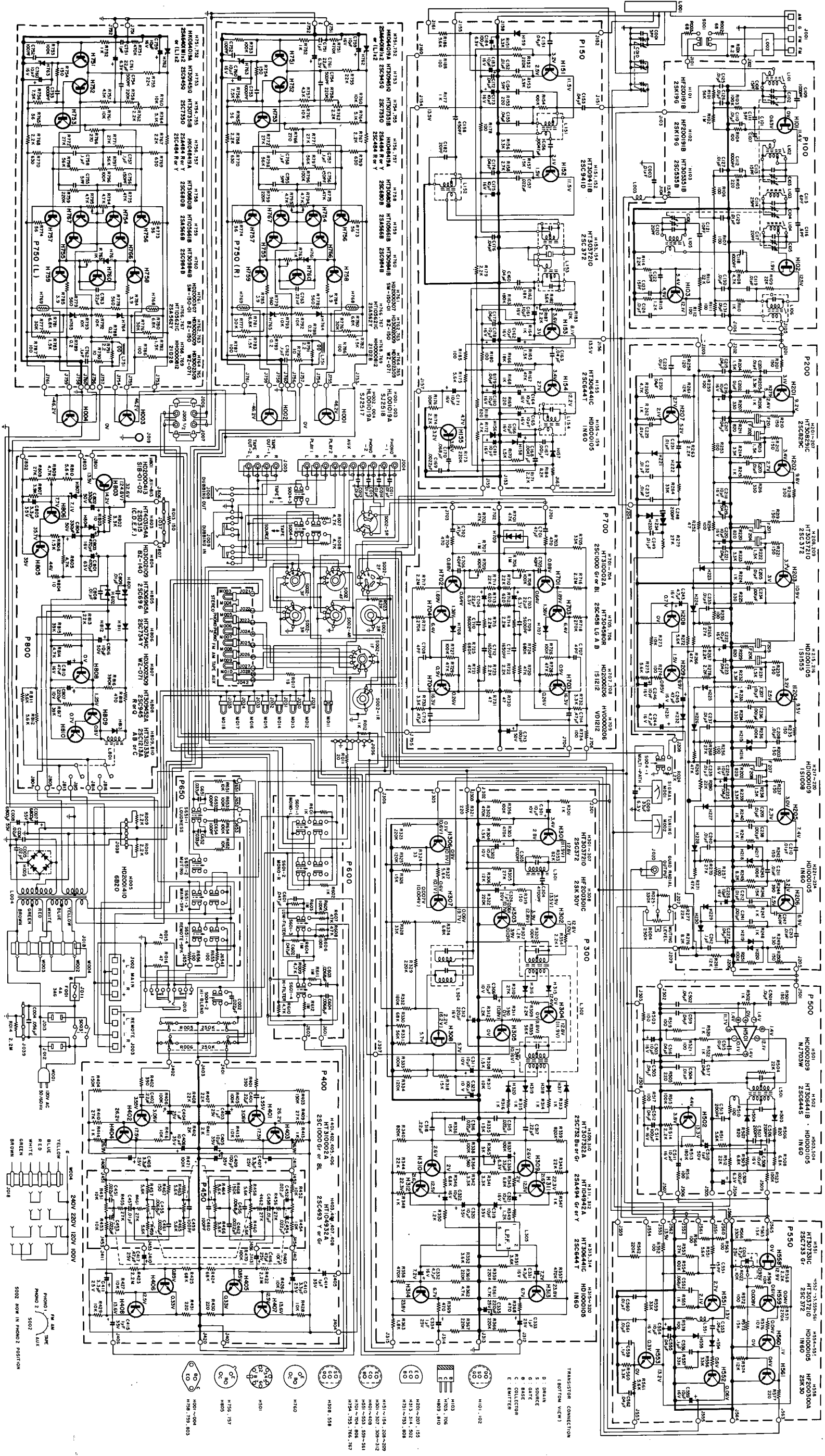

Figure 22 Schematic Diagram



REF. DESIG.	MARANTZ PART NO.	DESCRIPTION
A	281840140	Frame Assembly
0102	281806301	Escutcheon
0202	281840101	Frame
0204	281815801	Window
0215	273125901	Bush
0219	281805302	Cover
0226	281825905	Bush x 13
B	281815440	Knob Assembly
0111	281815404	Knob
0112	71400149Q	Spring
C	281815441	Knob Assembly
0114	281815405	Knob
0115	71400159Q	Spring
D	281816040	Front Bracket Assembly
0313	281816001	Bracket
0206	281811801	Spacer
E	281816041	Back Bracket Assembly
0313	281816002	Bracket
0902	51100308S	B.H.M. Screw x 12
0903	53110303E	Hexagon Nut x 12
0905	55060307F	T.R. Rivet x 4
0906	54050300R	T.L. Washer OR x 4
J012-J013	YJ0400018	Jack x 2
J020	YT0201006	Terminal
J004	YT0210002	Terminal
J005	YT0208002	Terminal
J001-J003	YT0304003	Terminal x 3
0104	281815401	Knob x 12
0106	281815402	Knob
0108	281815403	Knob x 3
0117	281825701	Lid
0118	281825702	Lid
0121	257706302	Escutcheon
0122	257706303	Escutcheon
0123	257727301	Fly Wheel
0126	281826501	Indicator
0208	281810701	Sheet
0210	281810301	Pointer
0211	281810302	Pointer
0212	281805301	Cover
0217	275905701	Leg x 4
0221	281830201	Dial
0302	281810550	Chassis K
0308	273010401	Retainer x 2
0315	281816003	Bracket
0316	281816004	Bracket
0321	281805501	Collar x 5
0323	281810102	Support x 2
0324	281810103	Support x 2
0326	281827401	Reflector

REF. DESIG.	MARANTZ PART NO.	DESCRIPTION
0327	281827402	Reflector
0329	281827101	Holder
0330	281927106	Holder
0331	281827103	Holder
0332	281927107	Holder
0401	281805101	Guide
0403	281816005	Bracket
0406	281810650	Bearing K
0410	257811202	Shaft
0412	281826250	Pulley K
0417	281826251	Pulley K
0422	257912001	Insulator
0423	281812001	Insulator
0425	141511801	Spacer
0426	257710602	Bearing
0501	257816052	Bracket K
0506	145525901	Bush x 2
0508	53228059E	Nut
0510	281816006	Bracket
0516	281826701	Heat Sink x 2
0518	281810104	Support x 8
0520	281816007	Bracket x 4
0522	257711802	Spacer x 4
0524-0245	257711806	Spacer x 5
0526	273026702	Heat-Sink x 4
0528	273026704	Heat-Sink x 4
0530	281926705	Heat-Sink x 2
0532	257700501	Clamper x 2
0533	59110339H	Washer x 2
0535	281910101	Support x 2
0601	281800450	Table K
0604	281910902	Shield
0605	282210903	Shield
0607	281912001	Insulator x 2
0608	281910901	Shield
0609	281912002	Insulator x 2
0611	281810950	Shield K
0615	281816008	Bracket x 2
0616	281811201	Shaft
0617	281810902	Shield
0618	281810903	Shield
0619	281810904	Shield x 2
0620	281810905	Shield
0623	281810107	Support x 4
0624	281816009	Bracket x 2
0626	281810906	Shield
0627	281810907	Shield
0629	281826901	Protector
0630	282126902	Protector
0631	282112001	Insulator
0632	281810908	Shield
0633	114325901	Bush x 2

REF. DESIG.	MARANTZ PART NO.	DESCRIPTION
0634	114325902	Bush x 2
0701	282815901	Drum
0703	71101569M	Spring
0705	281805850	Gear K x 2
0710	71101669Q	Spring x 2
0711	120225801	Hook
0716	273025901	Bush x 3
0718	138200503	Clamper x 15
0722	72081604A	String x 12
0725	257711803	Spacer x 4
0727	281910701	Sheet
0729	282111801	Spacer
0732	282100501	Clamper x 2
0734	281927103	Holder
0735	281805102	Guide
0802	51570305B	P.H.Tapt Screw x 8
0804	51570306B	P.H.Tapt Screw x 7
0806	51570312B	P.H.Tapt Screw x 5
0808	51570306B	P.H.Tapt Screw x 2
0809	51040306A	F.H.M. Screw x 2
0810	51640412D	Set Screw C.P.
0811	54040402A	Spring Washer
0812	53110403E	Hexagon Nut
0814	51570408B	P.H.Tapt Screw x 2
0815	51570306B	P.H.Tapt Screw x 4
0816	51570306B	P.H.Tapt Screw x 6
0818	51042606S	F.H.M. Screw x 6
0820	51570306B	P.H.Tapt Screw x 3
0821	51570306B	P.H.Tapt Screw x 6
0822	51570306B	P.H.Tapt Screw x 2
0823	51570306B	P.H.Tapt Screw x 3
0824	51570306B	P.H.Tapt Screw x 2
0831	53110603A	Hexagon Nut
0832	54020603A	Spring Washer
0834	51040308A	F.H.M. Screw x 2
0835	51570305B	P.H.Tapt Screw x 2
0906	54050300R	T.L. Washer OR x 4
0909	51100306S	B.H.Tapt Screw x 6
0910	51100306S	B.H.Tapt Screw x 3
0911	51100306S	B.H.Tapt Screw x 2
0912	51100306S	B.H.Tapt Screw x 2
0913	51100306S	B.H.Tapt Screw x 2
0914	51570312B	P.H.Tapt Screw x 4
0917	51100304S	B.H.M. Screw x 2
0919	51100308S	B.H.M. Screw x 2
0920	54050300R	T.L. Washer OR x 2
0921	53110303E	Hexagon Nut x 2
0923	54050400R	T.L. Washer OR
0926	51122608E	T.H.M. Screw x 4
0928	51100406S	B.H.M. Screw x 10
0930	51100406S	B.H.M. Screw x 4
0931	54020401S	Flat Washer P x 4

REF. DESIG.	MARANTZ PART NO.	DESCRIPTION
0933	51570410B	P.H.Tapt Screw x 4
0934	54020401E	Flat Washer D x 4
0935	54040402N	Spring Washer x 4
1002	51570306B	P.H.Tapt Screw x 12
1003	51570306B	P.H.Tapt Screw x 8
1005	51040314E	F.H.M. Screw x 8
1008	51100314E	B.H.M. Screw x 8
1009	54050300R	T.L. Washer OR x 16
1010	53110301E	Hexagon Nut x 8
1011	53110303E	Hexagon Nut x 8
1013	51100306S	B.H.M. Screw x 10
1015	51102608E	B.H.M. Screw x 2
1017	51060425E	P.H.M. Screw x 2
1018	54050400R	T.L. Washer OR x 2
1019	54040402N	Spring Washer x 2
1020	53110403E	Hexagon Nut x 2
1022	53110403E	Hexagon Nut
1023	54040402N	Spring Washer
1026	51570408B	P.H.Tapt Screw x 4
1027	53110403A	Hexagon Nut x 4
1028	54020401A	Flat Washer P x 4
1030	54040502A	Spring Washer x 4
1031	51060512A	P.H.M. Screw x 4
1032	53110501A	Hexagon Nut x 4
1033	54020501A	Flat Washer P x 8
1034	62031650W	Lug x 5
1035	54050300R	T.L. Washer OR x 15
1102	51100306S	B.H.M. Screw x 4
1103	51100306S	B.H.M. Screw x 4
1104	51100306S	B.H.M. Screw x 4
1105	51100306S	B.H.M. Screw x 4
1106	51100306S	B.H.M. Screw x 5
1107	51100306S	B.H.M. Screw x 4
1108	51100306S	B.H.M. Screw x 4
1109	51100306S	B.H.M. Screw x 4
1110	51100306S	B.H.M. Screw x 4
1113	51570306B	P.H.Tapt Screw x 3
1114	62031650W	Lug x 6
1115	54020301E	Flat Washer P x 2
1121	51570306B	P.H.Tapt Screw x 4
1122	51570306B	P.H.Tapt Screw x 4
1123	51570306B	P.H.Tapt Screw x 3
1124	51570306B	P.H.Tapt Screw x 8
1125	51570306B	P.H.Tapt Screw x 2
1126	51570306B	P.H.Tapt Screw x 4
1127	51570312R	P.H.Tapt Screw x 2
1128	51570306B	P.H.Tapt Screw x 4
1129	51570306B	P.H.Tapt Screw x 15
1130	51570306B	P.H.Tapt Screw x 6
1202	51650304D	Set Screw H.P. x 4
1204	64000400R	RG Ring E
1206	51100304E	B.H.M. Screw x 3

REF. DESIG.	MARANTZ PART NO.	DESCRIPTION
1212	56382540G	Eyelet x 3
1216	51100310S	B.H.M. Screw x 2
1217	53110303E	Hexagon Nut x 2
1218	54050300R	T.L. Washer OR x 2
1221	53112603E	Hexagon Nut
1222	54052600R	T.L. Washer OR
1223	59030810P	Fiber Washer
1224	54060300R	T.L. Washer 1R x 5
1225	51060305E	P.H.M. Screw x 3
1227	51570306B	P.H.Tapt Screw x 2
1229	51570306B	P.H.Tapt Screw x 2
1231	54040302N	Spring Washer x 4

REF. DESIG.	MARANTZ PART NO.	DESCRIPTION
P100	YD2818001 (ZZ2818001)	P.C. Board for Tuner P.C. Board Assembly
RESISTORS		
R101	RT1056314	Carbon, 56K $\Omega$ , $\pm 10\%$ , 1/4W
R102	RT1010514	Carbon, 1M $\Omega$ , $\pm 10\%$ , 1/4W
R103	RT1010414	Carbon, 100K $\Omega$ , $\pm 10\%$ , 1/4W
R104	RT1010114	Carbon, 100 $\Omega$ , $\pm 10\%$ , 1/4W
R105	RT1022114	Carbon, 200 $\Omega$ , $\pm 10\%$ , 1/4W
R106-R107	RT1010114	Carbon, 100 $\Omega$ , $\pm 10\%$ , 1/4W
R108	RT1047214	Carbon, 4.7K $\Omega$ , $\pm 10\%$ , 1/4W
R109	RT1022314	Carbon, 22K $\Omega$ , $\pm 10\%$ , 1/4W
R110	RT1010214	Carbon, 1K $\Omega$ , $\pm 10\%$ , 1/4W
R111-R112	RT1010114	Carbon, 100 $\Omega$ , $\pm 10\%$ , 1/4W
R113-R114	RT1022314	Carbon, 22K $\Omega$ , $\pm 10\%$ , 1/4W
R115	RT1012214	Carbon, 1.2K $\Omega$ , $\pm 10\%$ , 1/4W
CAPACITORS		
C101	CA5000001	Variable, FM 5 Gang
C102-C106	CT1100001	Trimmer, 1.5-11. 5pF
C107	CT1100002	Trimmer, 1.5-11. 5pF
C108	DD1615001	Ceramic, 15pF $\pm 10\%$ , 50V
C109	DK1710201	Ceramic, 1000pF, $\pm 10\%$ , 50V
C110	DK1710301	Ceramic, 0.01pF, $\pm 20\%$ , 50V
C111	DD1105001	Ceramic, 5pF, $\pm 0.5pF$ , SL
C112	DK1710201	Ceramic, 1000pF, $\pm 20\%$ , YY
C113	DD1615001	Ceramic, 15pF, $\pm 10\%$ , SL
C114	DD1625001	Ceramic, 25pF, $\pm 10\%$ , SL
C115-C116	DD1600601	Ceramic, 0.6pF, $\pm 10\%$ , AX
C117	DD1620001	Ceramic, 20pF, $\pm 20\%$ , SL
C118	DK1710201	Ceramic, 1000pF, $\pm 20\%$ , YY
C119	DK1710301	Ceramic, 0.01 $\mu F$ , $\pm 20\%$ , YY
C120	DD1620003	Ceramic, 20pF, $\pm 10\%$ , SH
C121	DD1210006	Ceramic, 10pF, $\pm 10\%$ , CH
C122-C123	DD1615003	Ceramic, 15pF, $\pm 10\%$ , CH
C124-C127	DK1710301	Ceramic, 0.01 $\mu F$ , $\pm 20\%$ , YY
C129-C131	DK1710301	Ceramic, 0.01 $\mu F$ , $\pm 20\%$ , YY
TRANSFORMERS		
L101	LA1027801	Ant. Coil
L102	LA1027802	RF Coil
L103	LA1027803	RF Coil
L104	LA1027804	RF Coil
L105	LQ1202604	OSC Coil
L106	LI1001601	IFT
SEMICONDUCTORS		
H101-H102	HF200191B	Transistor, 2SK19G
H103	HT305351B	Transistor, 2SC535B
MISCELLANEOUS		
J101-J106	YP1000094	Plug

REF. DESIG.	MARANTZ PART NO.	DESCRIPTION
P150	YD2818002 (ZZ2818002)	P.C. Board for AM IF P.C. Board Assembly
RESISTORS		
R151	RT1033214	Carbon, 3.3K $\Omega$ , $\pm$ 10%, 1/4W
R152	RT1022414	Carbon, 220K $\Omega$ , $\pm$ 10%, 1/4W
R153	RT1039214	Carbon, 3.9K $\Omega$ , $\pm$ 10%, 1/4W
R154	RT1010414	Carbon, 100K $\Omega$ , $\pm$ 10%, 1/4W
R155	RT1022114	Carbon, 220 $\Omega$ , $\pm$ 10%, 1/4W
R156	RT1033214	Carbon, 3.3K $\Omega$ , $\pm$ 10%, 1/4W
R157	RT1015314	Carbon, 15K $\Omega$ , $\pm$ 10%, 1/4W
R158	RT1027214	Carbon, 2.7K $\Omega$ , $\pm$ 10%, 1/4W
R162	RT1018314	Carbon, 18K $\Omega$ , $\pm$ 10%, 1/4W
R163	RT1018414	Carbon, 180K $\Omega$ , $\pm$ 10%, 1/4W
R164	RT1010214	Carbon, 1K $\Omega$ , $\pm$ 10%, 1/4W
R165	RT1015214	Carbon, 1.5K $\Omega$ , $\pm$ 10%, 1/4W
R166	RT1018314	Carbon, 18K $\Omega$ , $\pm$ 10%, 1/4W
R167	RT1047314	Carbon, 47K $\Omega$ , $\pm$ 10%, 1/4W
R168	RT1010214	Carbon, 1K $\Omega$ , $\pm$ 10%, 1/4W
R169	RT1022114	Carbon, 220 $\Omega$ , $\pm$ 10%, 1/4W
R170	RT1015214	Carbon, 1.5K $\Omega$ , $\pm$ 10%, 1/4W
R171	RT1022214	Carbon, 2.2K $\Omega$ , $\pm$ 10%, 1/4W
R172	RT1047214	Carbon, 4.7K $\Omega$ , $\pm$ 10%, 1/4W
R173	RT1022414	Carbon, 220K $\Omega$ , $\pm$ 10%, 1/4W
R174	RT1022214	Carbon, 2.2K $\Omega$ , $\pm$ 10%, 1/4W
R175	RT1056214	Carbon, 5.6K $\Omega$ , $\pm$ 10%, 1/4W
R176	RT1010414	Carbon, 100K $\Omega$ , $\pm$ 10%, 1/4W
R177	RT1010214	Carbon, 1K $\Omega$ , $\pm$ 10%, 1/4W
R178	RT1010114	Carbon, 100 $\Omega$ , $\pm$ 10%, 1/4W
R179	RT1022214	Carbon, 2.2K $\Omega$ , $\pm$ 10%, 1/4W
R180	RT1010114	Carbon, 100 $\Omega$ , $\pm$ 10%, 1/4W
R181	RT1082114	Carbon, 820 $\Omega$ , $\pm$ 10%, 1/4W
R182	RT1056214	Carbon, 5.6K $\Omega$ , $\pm$ 10%, 1/4W
R183	RT1012314	Carbon, 12K $\Omega$ , $\pm$ 10%, 1/4W
R184	RT1082214	Carbon, 8.2K $\Omega$ , $\pm$ 10%, 1/4W
R185	RT1010114	Carbon, 100 $\Omega$ , $\pm$ 10%, 1/4W
R186	RT1056214	Carbon, 5.6K $\Omega$ , $\pm$ 10%, 1/4W
R187	RT1022214	Carbon, 2.2K $\Omega$ , $\pm$ 10%, 1/4W
R188	RT1010114	Carbon, 100 $\Omega$ , $\pm$ 10%, 1/4W
CAPACITORS		
C151	DF1740301	Mylar, 0.04 $\mu$ F, $\pm$ 20%
C152	DF1710301	Mylar, 0.01 $\mu$ F, $\pm$ 20%
C153	DF1740301	Mylar, 0.04 $\mu$ F, $\pm$ 20%
C154	DD1105001	Ceramic, 5pF, $\pm$ 0.25pF
C155	DF1740301	Mylar, 0.04 $\mu$ F, $\pm$ 20%
C156	DF1747201	Mylar, 0.0047 $\mu$ F, $\pm$ 20%
C157	DF1722301	Mylar, 0.022 $\mu$ F, $\pm$ 20%
C158	DF6545101	Mylar, 450pF, $\pm$ 5%
C160	DF1740301	Mylar, 0.04 $\mu$ F, $\pm$ 20%
C161-C162	EA1060169	Elect., 10 $\mu$ F, 16V
C163	DF1740301	Mylar, 0.04 $\mu$ F, $\pm$ 20%
C164-C166	EA1060169	Elect., 10 $\mu$ F, 16V

REF. DESIG.	MARANTZ PART NO.	DESCRIPTION
C167	DK1710201	Ceramic, 0.001 $\mu$ F, $\pm$ 20%
C168	DF1747201	Mylar, 0.0047 $\mu$ F, $\pm$ 20%
C169	DF1722201	Mylar, 0.0022 $\mu$ F, $\pm$ 20%
C170	DF1668301	Mylar, 0.068 $\mu$ F, $\pm$ 10%
C171	EA1060169	Elect., 10 $\mu$ F, 16V
C172	DF1740301	Mylar, 0.04 $\mu$ F, $\pm$ 20%
C173	EA1060169	Elect., 10 $\mu$ F, 16V
C174	DF1740301	Mylar, 0.04 $\mu$ F, $\pm$ 20%
C175	EA1060169	Elect., 10 $\mu$ F, 16V
C176-C177	DF1740301	Mylar, 0.04 $\mu$ F, $\pm$ 20%
C178	EA1060169	Elect., 10 $\mu$ F, 16V
C179	DF1740301	Mylar, 0.04 $\mu$ F, $\pm$ 20%
C180-C181	EA1060169	Elect., 10 $\mu$ F, 16V
C182	DD1620001	Ceramic, 20pF, $\pm$ 10%
C183	EA1060169	Elect., 10 $\mu$ F, 16V
C184	EA1070109	Elect., 100 $\mu$ F, 10V
TRANSFORMERS		
L151	LA1001017	RF Coil, 200 $\mu$ H
L152	LO1001042	OSC Coil, 120 $\mu$ H
L153	LI1028002	IFT
L154	LI1001048	IFT
SEMICONDUCTORS		
H151-H152	HT309411B	Transistor, 2SC941 (O)
H153-H154	HT3037210	Transistor, 2SC372
H155	HT306441C	Transistor, 2SC644 (T)
H156-H159	HD1000105	Diode, 1N60
MISCELLANEOUS		
J151-J162	YP1000094	Plug
P200	YD2818014 (ZZ2818014)	P.C. Board for FM IF P.C. Board Assembly
RESISTORS		
R201	RT1015114	Carbon, 150 $\Omega$ , $\pm$ 10%, 1/4W
R202	RT1082114	Carbon, 820 $\Omega$ , $\pm$ 10%, 1/4W
R203	RT1015114	Carbon, 150 $\Omega$ , $\pm$ 10%, 1/4W
R204	RT1015214	Carbon, 1.5K $\Omega$ , $\pm$ 10%, 1/4W
R205	RT1033214	Carbon, 3.3K $\Omega$ , $\pm$ 10%, 1/4W
R206	RT1010214	Carbon, 1K $\Omega$ , $\pm$ 10%, 1/4W
R207	RT1033114	Carbon, 330 $\Omega$ , $\pm$ 10%, 1/4W
R210	RT1015114	Carbon, 150 $\Omega$ , $\pm$ 10%, 1/4W
R211	RT1082114	Carbon, 820 $\Omega$ , $\pm$ 10%, 1/4W
R212	RT1015114	Carbon, 150 $\Omega$ , $\pm$ 10%, 1/4W
R213	RT1015214	Carbon, 1.5K $\Omega$ , $\pm$ 10%, 1/4W
R214	RT1033214	Carbon, 3.3K $\Omega$ , $\pm$ 10%, 1/4W
R215	RT1010214	Carbon, 1K $\Omega$ , $\pm$ 10%, 1/4W
R216	RT1033114	Carbon, 330 $\Omega$ , $\pm$ 10%, 1/4W
R218	RT0530114	Carbon, 300 $\Omega$ , $\pm$ 5%
R220	RT1082114	Carbon, 820 $\Omega$ , $\pm$ 10%, 1/4W
R221	RT1015114	Carbon, 150 $\Omega$ , $\pm$ 10%, 1/4W
R222	RT1015214	Carbon, 1.5K $\Omega$ , $\pm$ 10%, 1/4W
R223	RT1033214	Carbon, 3.3K $\Omega$ , $\pm$ 10%, 1/4W

REF. DESIG.	MARANTZ PART NO.	DESCRIPTION		
R224	RT1010214	Carbon, 1K $\Omega$ ,	$\pm 10\%$ ,	1/4W
R225	RT1033114	Carbon, 330 $\Omega$ ,	$\pm 10\%$ ,	1/4W
R229	RT1082114	Carbon, 820 $\Omega$ ,	$\pm 10\%$ ,	1/4W
R230	RT1015114	Carbon, 150 $\Omega$ ,	$\pm 10\%$ ,	1/4W
R232	RT1033214	Carbon, 3.3K $\Omega$ ,	$\pm 10\%$ ,	1/4W
R233	RT1010214	Carbon, 1K $\Omega$ ,	$\pm 10\%$ ,	1/4W
R234	RT1033114	Carbon, 330 $\Omega$ ,	$\pm 10\%$ ,	1/4W
R235	RT1015114	Carbon, 150 $\Omega$ ,	$\pm 10\%$ ,	1/4W
R236	RT1010414	Carbon, 100K $\Omega$ ,	$\pm 10\%$ ,	1/4W
R237	RT1015114	Carbon, 150 $\Omega$ ,	$\pm 10\%$ ,	1/4W
R238	RT1015214	Carbon, 1.5K $\Omega$ ,	$\pm 10\%$ ,	1/4W
R239	RT1033214	Carbon, 3.3K $\Omega$ ,	$\pm 10\%$ ,	1/4W
R240-R241	RT1010214	Carbon, 1K $\Omega$ ,	$\pm 10\%$ ,	1/4W
R242	RT1015114	Carbon, 150 $\Omega$ ,	$\pm 10\%$ ,	1/4W
R243	RT1010414	Carbon, 100K $\Omega$ ,	$\pm 10\%$ ,	1/4W
R244	RT1039114	Carbon, 390 $\Omega$ ,	$\pm 10\%$ ,	1/4W
R245	RT1082214	Carbon, 8.2K $\Omega$ ,	$\pm 10\%$ ,	1/4W
R231	RT1015214	Carbon, 1.5K $\Omega$ ,	$\pm 10\%$ ,	1/4W
R246	RT1015314	Carbon, 15K $\Omega$ ,	$\pm 10\%$ ,	1/4W
R247-R248	RT1010214	Carbon, 1K $\Omega$ ,	$\pm 10\%$ ,	1/4W
R249	RT1033114	Carbon, 330 $\Omega$ ,	$\pm 10\%$ ,	1/4W
R250	RT1015114	Carbon, 150 $\Omega$ ,	$\pm 10\%$ ,	1/4W
R251	RT1010414	Carbon, 100K $\Omega$ ,	$\pm 10\%$ ,	1/4W
R252	RT1047014	Carbon, 47 $\Omega$ ,	$\pm 10\%$ ,	1/4W
R253-R257	RT1010114	Carbon, 100 $\Omega$ ,	$\pm 10\%$ ,	1/4W
R258	RT1012114	Carbon, 120 $\Omega$ ,	$\pm 10\%$ ,	1/4W
R259	RT1010114	Carbon, 100 $\Omega$ ,	$\pm 10\%$ ,	1/4W
R260	RT1047214	Carbon, 4.7K $\Omega$ ,	$\pm 10\%$ ,	1/4W
R261	RT1012314	Carbon, 12K $\Omega$ ,	$\pm 10\%$ ,	1/4W
R262	RT1010214	Carbon, 1K $\Omega$ ,	$\pm 10\%$ ,	1/4W
R263	RT1022214	Carbon, 2.2K $\Omega$ ,	$\pm 10\%$ ,	1/4W
R264	RT1033314	Carbon, 33K $\Omega$ ,	$\pm 10\%$ ,	1/4W
R265	RT1027314	Carbon, 27K $\Omega$ ,	$\pm 10\%$ ,	1/4W
R266	RT1047314	Carbon, 47K $\Omega$ ,	$\pm 10\%$ ,	1/4W
R267	RT1022214	Carbon, 2.2K $\Omega$ ,	$\pm 10\%$ ,	1/4W
R268	RT1027314	Carbon, 27K $\Omega$ ,	$\pm 10\%$ ,	1/4W
R269	RT1047314	Carbon, 47K $\Omega$ ,	$\pm 10\%$ ,	1/4W
R270	RT1027314	Carbon, 27K $\Omega$ ,	$\pm 10\%$ ,	1/4W
R271	RT1047314	Carbon, 47K $\Omega$ ,	$\pm 10\%$ ,	1/4W
R272	RT1056214	Carbon, 5.6K $\Omega$ ,	$\pm 10\%$ ,	1/4W
R273	RT1010314	Carbon, 10K $\Omega$ ,	$\pm 10\%$ ,	1/4W
R274	RT1010114	Carbon, 100 $\Omega$ ,	$\pm 10\%$ ,	1/4W
R275	RT1056214	Carbon, 5.6K $\Omega$ ,	$\pm 10\%$ ,	1/4W
R276	RT1023314	Carbon, 22K $\Omega$ ,	$\pm 10\%$ ,	1/4W
R277	RT1082214	Carbon, 8.2K $\Omega$ ,	$\pm 10\%$ ,	1/4W
R278	RT1022214	Carbon, 2.2K $\Omega$ ,	$\pm 10\%$ ,	1/4W
R279	RT1027314	Carbon, 27K $\Omega$ ,	$\pm 10\%$ ,	1/4W
R280	RT1022314	Carbon, 22K $\Omega$ ,	$\pm 10\%$ ,	1/4W
R281	RT1012314	Carbon, 12K $\Omega$ ,	$\pm 10\%$ ,	1/4W
		CAPACITORS		
C201-C203	DK1710301	Ceramic, 0.01 $\mu$ F,	$\pm 20\%$ ,	

REF. DESIG.	MARANTZ PART NO.	DESCRIPTION		
C205	DK1710301	Ceramic, 0.01 $\mu$ F,	$\pm 20\%$	
C207-C213	DK1710301	Ceramic, 0.01 $\mu$ F,	$\pm 20\%$	
C215	DK1840302	Ceramic, 0.04 $\mu$ F,	+100%, -0%	
C216	EA1060169	Elect., 10 $\mu$ F,	16V	
C217	DK1840302	Ceramic, 0.04 $\mu$ F,	+100%, -0%	
C218	EA1060169	Elect., 10 $\mu$ F,	16V	
C219	DK1840302	Ceramic, 0.04 $\mu$ F,	+100%, -0%	
C220	EA1060169	Elect., 10 $\mu$ F,	16V	
C221	DK1840302	Ceramic, 0.04 $\mu$ F,	+100%, -0%	
C222	EA1060169	Elect., 10 $\mu$ F,	16V	
C223	DK1840302	Ceramic, 0.04 $\mu$ F,	+100%, -0%	
C224	EA1060169	Elect., 10 $\mu$ F,	16V	
C225	DK1840302	Ceramic, 0.04 $\mu$ F,	+100%, -0%	
C226	EA1060169	Elect., 10 $\mu$ F,	16V	
C227	DK1840302	Ceramic, 0.04 $\mu$ F,	+100%, -0%	
C228-C229,	DK1710301	Ceramic, 0.01 $\mu$ F,	$\pm 20\%$	
C230	DK1840302	Ceramic, 0.04 $\mu$ F,	+100%, -0%	
C231-C233	DK1710301	Ceramic, 0.01 $\mu$ F,	$\pm 20\%$	
C234	DK1710201	Ceramic, 0.001 $\mu$ F,	$\pm 20\%$	
C235	DK1710301	Ceramic, 0.01 $\mu$ F,	$\pm 20\%$	
C236	DK1710201	Ceramic, 0.001 $\mu$ F,	$\pm 20\%$	
C237	DK1710301	Ceramic, 0.01 $\mu$ F,	$\pm 20\%$	
C238	DK1710201	Ceramic, 0.001 $\mu$ F,	$\pm 20\%$	
C239-C240	DK1710301	Ceramic, 0.01 $\mu$ F,	$\pm 20\%$	
C241	DK1710201	Ceramic, 0.001 $\mu$ F,	$\pm 20\%$	
C242	DK1810402	Ceramic, 0.1 $\mu$ F,	+100%, -0%	
C243-C245	EA4750359	Elect., 4.7 $\mu$ F,	35V	
C246	EA1060169	Elect., 10 $\mu$ F,	16V	
C247	DD1540001	Ceramic, 40pF,	$\pm 5\%$	
C248	DD1620101	Ceramic, 200pF,	$\pm 10\%$	
C249	DK1710301	Ceramic, 0.01 $\mu$ F,	$\pm 20\%$	
		SEMICONDUCTORS		
H201-H207	HT308291C	Transistor, 2SC829C		
H208-H209	HT3037210	Transistor, 2SC372		
H215-H216	HD2001105	Diode, 1S1555		
H217-H220	HD1000109	Diode, 1S1008		
H221-H234	HD1000105	Diode, 1N60		
		MISCELLANEOUS		
F201-F208	FF1107003	Ceramic Filter, SFA 10.7MHz		
J201-J209	YP1000094	Plug,		
P300	YD2818004 (ZZ2818004)	P.C. Board for M.P.X P.C. Board Assembly		
		RESISTORS		
R301	RT1010214	Carbon, 1K $\Omega$ ,	$\pm 10\%$ ,	1/4W
R302-R303	RT1047414	Carbon, 470K $\Omega$ ,	$\pm 10\%$ ,	1/4W
R304	RT1015214	Carbon, 1.5K $\Omega$ ,	$\pm 10\%$ ,	1/4W
R305	RT1027314	Carbon, 27K $\Omega$ ,	$\pm 10\%$ ,	1/4W
R306	RT1012314	Carbon, 12K $\Omega$ ,	$\pm 10\%$ ,	1/4W
R307	RT1012214	Carbon, 1.2K $\Omega$ ,	$\pm 10\%$ ,	1/4W

REF. DESIG.	MARANTZ PART NO.	DESCRIPTION		
R308	RT1015214	Carbon, 1.5K $\Omega$ ,	$\pm 10\%$ ,	1/4W
R309	RT1022214	Carbon, 2.2K $\Omega$ ,	$\pm 10\%$ ,	1/4W
R310	RT1027314	Carbon, 27K $\Omega$ ,	$\pm 10\%$ ,	1/4W
R311	RT1039114	Carbon, 390 $\Omega$ ,	$\pm 10\%$ ,	1/4W
R312	RT1012214	Carbon, 1.2K $\Omega$ ,	$\pm 10\%$ ,	1/4W
R313-R316	RT0510214	Carbon, 1K $\Omega$ ,	$\pm 5\%$ ,	1/4W
R317	RT1010314	Carbon, 10K $\Omega$ ,	$\pm 10\%$ ,	1/4W
R318	RT1015314	Carbon, 15K $\Omega$ ,	$\pm 10\%$ ,	1/4W
R319	RT1015114	Carbon, 150 $\Omega$ ,	$\pm 10\%$ ,	1/4W
R320	RT1010414	Carbon, 100K $\Omega$ ,	$\pm 10\%$ ,	1/4W
R321	RT1022214	Carbon, 2.2K $\Omega$ ,	$\pm 10\%$ ,	1/4W
R322-R323	RT1022414	Carbon, 220K $\Omega$ ,	$\pm 10\%$ ,	1/4W
R324	RT1033014	Carbon, 330 $\Omega$ ,	$\pm 10\%$ ,	1/4W
R325	RT1012414	Carbon, 120K $\Omega$ ,	$\pm 10\%$ ,	1/4W
R326	RT1015314	Carbon, 15K $\Omega$ ,	$\pm 10\%$ ,	1/4W
R327	RT1056214	Carbon, 5.6K $\Omega$ ,	$\pm 10\%$ ,	1/4W
R328	RT1033314	Carbon, 33K $\Omega$ ,	$\pm 10\%$ ,	1/4W
R329	RT1022414	Carbon, 220K $\Omega$ ,	$\pm 10\%$ ,	1/4W
R330	RT1068314	Carbon, 68K $\Omega$ ,	$\pm 10\%$ ,	1/4W
R331	RT1056314	Carbon, 56K $\Omega$ ,	$\pm 10\%$ ,	1/4W
R332	RT0518414	Carbon, 180K $\Omega$ ,	$\pm 5\%$ ,	1/4W
R333	RT1010414	Carbon, 100K $\Omega$ ,	$\pm 10\%$ ,	1/4W
R334	RT1012414	Carbon, 120K $\Omega$ ,	$\pm 10\%$ ,	1/4W
R335-R336	RT0515314	Carbon, 15K $\Omega$ ,	$\pm 5\%$ ,	1/4W
R337-R338	RT0510414	Carbon, 100K $\Omega$ ,	$\pm 5\%$ ,	1/4W
R339-R340	RN0582414	Carbon, 820K $\Omega$ ,	$\pm 5\%$ ,	1/4W
R341-R342	RT0512214	Carbon, 1.2K $\Omega$ ,	$\pm 5\%$ ,	1/4W
R343-R344	RN0522314	Carbon, 22K $\Omega$ ,	$\pm 5\%$ ,	1/4W
R345-R346	RT0568214	Carbon, 6.8K $\Omega$ ,	$\pm 5\%$ ,	1/4W
R347-R348	RT0510214	Carbon, 1K $\Omega$ ,	$\pm 5\%$ ,	1/4W
R349-R350	RT0512214	Carbon, 1.2K $\Omega$ ,	$\pm 5\%$ ,	1/4W
R351-R352	RT0536214	Carbon, 3.6K $\Omega$ ,	$\pm 5\%$ ,	1/4W
R353	RT1082314	Carbon, 82K $\Omega$ ,	$\pm 10\%$ ,	1/4W
R354	RT1022214	Carbon, 2.2K $\Omega$ ,	$\pm 10\%$ ,	1/4W
R355	RT1056314	Carbon, 56K $\Omega$ ,	$\pm 10\%$ ,	1/4W
R356	RT1010414	Carbon, 100K $\Omega$ ,	$\pm 10\%$ ,	1/4W
R357-R358	RN1047414	Carbon, 470K $\Omega$ ,	$\pm 10\%$ ,	1/4W
R359-R360	RN1022414	Carbon, 220K $\Omega$ ,	$\pm 10\%$ ,	1/4W
R361-R362	RT1047214	Carbon, 4.7K $\Omega$ ,	$\pm 10\%$ ,	1/4W
R363	RT1018214	Carbon, 1.8K $\Omega$ ,	$\pm 10\%$ ,	1/4W
R364	RT1056114	Carbon, 560K $\Omega$ ,	$\pm 10\%$ ,	1/4W
R365	RA0502013	Trimmer, 5K $\Omega$ , (B)		
R366-R367	RT1022414	Carbon, 220K $\Omega$ ,	$\pm 10\%$ ,	1/4W
R368-R369	RT1047114	Carbon, 470 $\Omega$ ,	$\pm 10\%$ ,	1/4W
R374	RT1068214	Carbon, 6.8K $\Omega$ ,	$\pm 10\%$ ,	1/4W
		CAPACITORS		
C301-C302	EA1060169	Elect., 10 $\mu$ F,	16V	
C303	DF5547203	Mylar, 4700pF,	$\pm 5\%$	
C304	DF1647201	Mylar, 4700pF,	$\pm 10\%$	
C306	EA1060169	Elect., 10 $\mu$ F,	16V	
C311	EA1060169	Elect., 10 $\mu$ F,	16V	

REF. DESIG.	MARANTZ PART NO.	DESCRIPTION		
C312	EA2270169	Elect., 220 $\mu$ F,	16V	
C315-C316	DF1522301	Mylar, 0.022 $\mu$ F,	$\pm 5\%$	
C317-C318	DF1722401	Mylar, 0.22 $\mu$ F,	$\pm 20\%$	
C319-C320	EA1060359	Elect., 10 $\mu$ F,	35V	
C321-C322	EA1060169	Elect., 10 $\mu$ F,	16V	
C323	EA1070109	Elect., 100 $\mu$ F,	10V	
C324	EM1040201	Elect., 0.1 $\mu$ F,	20V	
C331-C332	EA4750359	Elect., 4.7 $\mu$ F,	45V	
C333-C334	EV1050251	Elect., 1 $\mu$ F,	25V	
C335	EA2270259	Elect., 220 $\mu$ F,	25V	
C336	EA3360109	Elect., 33 $\mu$ F,	10V	
		TRANSFORMERS		
L301	LS1001007	M.P.X Coil, 19KHz Amp.		
L302	LS1503002	M.P.X Coil, 19KHz, 38KHz Block		
L304	LS1503001	M.P.X Coil, 19KHz, 67KHz Trap.		
L305	LS3501002	M.P.X Coil, L.P. Filter		
		SEMICONDUCTORS		
H301-H307	HT3037210	Transistor, 2SC372		
H308	HF200301C	Transistor, 2SK30Y		
H309-H310	HT307322A	Transistor, 2SC732, Bu or Gr		
H311-H312	HT104942A	Transistor, 2SA494, Gr or Y		
H313-H314	HT306441C	Transistor, 2SC644T,		
H351-H320	HD1000105	Diode, 1N60		
		MISCELLANEOUS		
J301-J303	YP1000094	Plug		
J305-J307	YP1000094	Plug		
J312-J315	YP1000094	Plug		
P500	YD2818005 (ZZ2818005)	P.C. Board for Ratio Detector		
		P.C. Board Assembly		
		RESISTORS		
R501	RT1015114	Carbon, 150 $\Omega$ ,	$\pm 10\%$ ,	1/4W
R502	RT1010214	Carbon, 1K $\Omega$ ,	$\pm 10\%$ ,	1/4W
R503	RT1010114	Carbon, 100 $\Omega$ ,	$\pm 10\%$ ,	1/4W
R504	RT1022314	Carbon, 22K $\Omega$ ,	$\pm 10\%$ ,	1/4W
R505	RT1010114	Carbon, 100 $\Omega$ ,	$\pm 10\%$ ,	1/4W
R506-R507	RT0582114	Carbon, 820 $\Omega$ ,	$\pm 5\%$ ,	1/4W
R508-R509	RT0568214	Carbon, 6.8K $\Omega$ ,	$\pm 5\%$ ,	1/4W
R510	RT1010114	Carbon, 100 $\Omega$ ,	$\pm 10\%$ ,	1/4W
R511	RT1027214	Carbon, 2.7K $\Omega$ ,	$\pm 10\%$ ,	1/4W
R512	RT1022314	Carbon, 22K $\Omega$ ,	$\pm 10\%$ ,	1/4W
R513	RN1018414	Carbon, 180K $\Omega$ ,	$\pm 10\%$ ,	1/4W
R514	RT1022214	Carbon, 2.2K $\Omega$ ,	$\pm 10\%$ ,	1/4W
R515	RN1010414	Carbon, 100K $\Omega$ ,	$\pm 10\%$ ,	1/4W
R516-R517	RT1010114	Carbon, 100 $\Omega$ ,	$\pm 10\%$ ,	1/4W
R519	RT1010114	Carbon, 100 $\Omega$ ,	$\pm 10\%$ ,	1/4W
R520	RT1010214	Carbon, 1K $\Omega$ ,	$\pm 10\%$ ,	1/4W
R521	RT1010114	Carbon, 100 $\Omega$ ,	$\pm 10\%$ ,	1/4W
R522	RT1010214	Carbon, 1K $\Omega$ ,	$\pm 10\%$ ,	1/4W
R523	RT1010414	Carbon, 100K $\Omega$ ,	$\pm 10\%$ ,	1/4W

REF. DESIG.	MARANTZ PART NO.	DESCRIPTION
C501	DK1710301	Ceramic, 0.01 $\mu$ F, $\pm$ 20%, YY
C502	DK1840302	Ceramic, 0.04 $\mu$ F, +100%, -0%
C503	EA1060169	Elect., 10 $\mu$ F, 16V
C504-C505	DK1840302	Ceramic, 0.04 $\mu$ F, +100%, -0%
C506-C507	DD1620101	Ceramic, 200pF, $\pm$ 10%, SL
C508	EA1060169	Elect., 10 $\mu$ F, 16V
C509	EA1070109	Elect., 100 $\mu$ F, 10V
C510	ED1050501	Elect., 1 $\mu$ F, 50V
C511	EA1060169	Elect., 10 $\mu$ F, 16V
C512	DK1840302	Ceramic, 0.04 $\mu$ F, +100%, -0%
C513	DD1620101	Ceramic, 200pF, $\pm$ 10%
C514	EA1070169	Elect., 100 $\mu$ F, 16V
C515	DK1710301	Ceramic, 0.01 $\mu$ F, $\pm$ 20%
C516-C517	DK1840301	Ceramic, 0.04 $\mu$ F, +100%, -0%
C519	DK1840301	Ceramic, 0.04 $\mu$ F, +100%, -0%
C520	DK1840302	Ceramic, 0.04 $\mu$ F, +100%, -0%
SEMICONDUCTORS		
H501	HC1000209	IC, NJ703W
H502	HT306441B	Transistor, 2SC644S
H503-H504	HD1000105	Diode, 1N60
MISCELLANEOUS		
J501-J509	YP1000094	Plug
L501	LI1018801	IFT, FM Det.
P550	YD2818006 (ZZ2818006)	P.C. Board for Noise DC Amp. P.C. Board Assembly
RESISTORS		
R551	RT1056214	Carbon, 5.6K $\Omega$ , $\pm$ 10%, 1/4W
R552	RT1010114	Carbon, 100 $\Omega$ , $\pm$ 10%, 1/4W
R553	RT1027314	Carbon, 27K $\Omega$ , $\pm$ 10%, 1/4W
R554	RT1010414	Carbon, 100K $\Omega$ , $\pm$ 10%, 1/4W
R555	RT1010214	Carbon, 1K $\Omega$ , $\pm$ 10%, 1/4W
R556-R557	RT1033314	Carbon, 33K $\Omega$ , $\pm$ 10%, 1/4W
R559	RT1033314	Carbon, 33K $\Omega$ , $\pm$ 10%, 1/4W
R560-R561	RT1033214	Carbon, 3.3K $\Omega$ , $\pm$ 10%, 1/4W
R562	RT1018414	Carbon, 180K $\Omega$ , $\pm$ 10%, 1/4W
R563-R564	RT1010114	Carbon, 100 $\Omega$ , $\pm$ 10%, 1/4W
R565	RT1015314	Carbon, 15K $\Omega$ , $\pm$ 10%, 1/4W
R566	RT0533414	Carbon, 330K $\Omega$ , $\pm$ 5%, 1/4W
R568	RT1022214	Carbon, 2.2K $\Omega$ , $\pm$ 10%, 1/4W
R569	RT0510314	Carbon, 10K $\Omega$ , $\pm$ 5%, 1/4W
R571	RT0527414	Carbon, 270K $\Omega$ , $\pm$ 5%, 1/4W
R572	RT1010114	Carbon, 100 $\Omega$ , $\pm$ 10%, 1/4W
R573	RT0515314	Carbon, 15K $\Omega$ , $\pm$ 5%, 1/4W
R574	RT0512314	Carbon, 12K $\Omega$ , $\pm$ 5%, 1/4W
R576	RT0510314	Carbon, 10K $\Omega$ , $\pm$ 5%, 1/4W
R577	RT1022114	Carbon, 220K $\Omega$ , $\pm$ 10%, 1/4W
R578	RT1010114	Carbon, 100 $\Omega$ , $\pm$ 10%, 1/4W

REF. DESIG.	MARANTZ PART NO.	DESCRIPTION
CAPACITORS		
C551	DD1615001	Ceramic, 15pF, $\pm$ 10%, SL
C552	DF1668301	Ceramic, 0.068 $\mu$ F, $\pm$ 10%
C553	DF1740301	Mylar, 0.04 $\mu$ F, $\pm$ 20%
C554	EA1060162	Elect., 10 $\mu$ F, 16V
C555	DK1840302	Ceramic, 0.04 $\mu$ F, +100%, -0%
C556-C558	DK1810402	Ceramic, 0.1 $\mu$ F, +100%, -0%
C560-C561	DK1710301	Ceramic, 0.01 $\mu$ F, $\pm$ 20%
C562	DK1840302	Ceramic, 0.04 $\mu$ F, +30%, -20%
C559	EA1060162	Elect., 10 $\mu$ F, 16V
SEMICONDUCTORS		
H551	HT307331C	Transistor, 2SC733GR
H552-H553	HT3037210	Transistor, 2SC372
H554-H555	HD1000105	Diode, 1N60
H557	HD1000105	Diode, 1N60
H558	HF200300A	FET, 2SK30, GR
H559-H561	HT3037210	Transistor, 2SC372
MISCELLANEOUS		
L551	LC2105001	Choke Coil, 1mH
J551-J555	YP1000094	Plug
J557	YP1000094	Plug
J559-J566	YP1000094	Plug
P400	YD2577004 (ZZ2577004)	P.C. Board for Pre and Tone Amp. P.C. Board Assembly
RESISTORS		
R401-R402	RT1039114	Carbon, 390 $\Omega$ , $\pm$ 10%, 1/4W
R403-R404	RN1015414	Carbon, 150K $\Omega$ , $\pm$ 10%, 1/4W
R450-R406	RN1010414	Carbon, 100K $\Omega$ , $\pm$ 10%, 1/4W
R407-R408	RN1022314	Carbon, 22K $\Omega$ , $\pm$ 10%, 1/4W
R409-R410	RN1027314	Carbon, 27K $\Omega$ , $\pm$ 10%, 1/4W
R411-R412	RT0520214	Carbon, 2K $\Omega$ , $\pm$ 5%, 1/4W
R413-R414	RT1010214	Carbon, 1K $\Omega$ , $\pm$ 10%, 1/4W
R415-R416	RT0510314	Carbon, 10K $\Omega$ , $\pm$ 5%, 1/4W
R422-R423	RN1022514	Carbon, 2.2M $\Omega$ , $\pm$ 10%, 1/4W
R424-R425	RN1068314	Carbon, 68K $\Omega$ , $\pm$ 10%, 1/4W
R426-R429	RN1010314	Carbon, 10K $\Omega$ , $\pm$ 10%, 1/4W
R430-R431	RT0522114	Carbon, 220 $\Omega$ , $\pm$ 5%, 1/4W
CAPACITORS		
C401-C402	DF1722402	Mylar, 0.22 $\mu$ F, 50V, $\pm$ 20%
C403-C404	EV1050251	Elect., 1 $\mu$ F, 25V, +40%, -20%
C405-C406	EA1060359	Elect., 10 $\mu$ F, 35V, +100%, -0%
C407-C408	EV3350251	Elect., 3.3 $\mu$ F, 25V, +40%, -20%
C409	EA1070359	Elect., 100 $\mu$ F, 35V, +100%, -0%
C410-C411	EV3350251	Elect., 3.3 $\mu$ F, 25V, +40%, -20%
C414-C415	EV1050351	Elect., 1 $\mu$ F, 35V, +40%, -20%
SEMICONDUCTORS		
H401-H402	HT310002A	Transistor, 2SC1000 Gr or B1
H403-H404	HT104932A	Transistor, 2SA493 Y or Gr
H405-H406	HT310002A	Transistor, 2SC1000 Gr or B1

REF. DESIG.	MARANTZ PART NO	DESCRIPTION
H407-H408	HT104932A	Transistor, 2SA493 Y or Gr
MISCELLANEOUS		
J401-J403	YP1000036	Plug
J405-J407	YP1000036	Plug
J420	YP1000036	Plug
W401	YW2818002	Wire Material
P450	YD2818011 (ZZ2818011)	P.C. Board for Tone P.C. Board
RESISTORS		
R451-R454	RT0510314	Carbon, 10K $\Omega$ , $\pm$ 5%, 1/4W
R455-R456	RT0527314	Carbon, 27K $\Omega$ , $\pm$ 5%, 1/4W
R457-R460	RT0556214	Carbon, 5.6K $\Omega$ , $\pm$ 5%, 1/4W
R461-R462	RT0527314	Carbon, 27K $\Omega$ , $\pm$ 5%, 1/4W
R463-R466	RT0556214	Carbon, 5.6K $\Omega$ , $\pm$ 5%, 1/4W
R467-R468	RT0515414	Carbon, 150K $\Omega$ , $\pm$ 5%, 1/4W
R469-R471	RD0104005	Variable, 100K $\Omega$ , (B)
CAPACITORS		
C451-C454	DF1622301	Mylar, 0.022 $\mu$ F, $\pm$ 10%
C455-C456	DF1668201	Mylar, 0.006 $\mu$ F, 50V
C457-C458	DK1610301	Ceramic, 0.01 $\mu$ F, $\pm$ 10%
C459-C460	DD1510101	Ceramic, 100pF, $\pm$ 5%
C461-C462	DK1622201	Ceramic, 0.0022 $\mu$ F, $\pm$ 10%
MISCELLANEOUS		
J451-J456	5721952W	Lug Eyelet
P600	YD2818009 (ZZ2818009)	P.C. Board for Filter P.C. Board Assembly
RESISTORS		
R601-R602	RT1010214	Carbon, 1K $\Omega$ , $\pm$ 10%, 1/4W
R603-R604	RT0510514	Carbon, 1M $\Omega$ , $\pm$ 5%, 1/4W
R605-R606	RN1010414	Carbon, 100K $\Omega$ , $\pm$ 10%, 1/4W
R607-R608	RT0547314	Carbon, 47K $\Omega$ , $\pm$ 5%, 1/4W
R609-R610	RT0547214	Carbon, 4.7K $\Omega$ , $\pm$ 5%, 1/4W
R611-R612	RT0510514	Carbon, 1M $\Omega$ , $\pm$ 5%, 1/4W
CAPACITORS		
C601-C602	DF1647301	Mylar, 0.047 $\mu$ F, $\pm$ 10%, 50V
C603-C604	DF1668201	Mylar, 0.0068 $\mu$ F, $\pm$ 10%, 50V
MISCELLANEOUS		
S601	SP0404002	Push Switch, Mode, Hi/Low Filter
J601-J602	YP1000094	Plug
P650	YD2818008 (ZZ2818008)	P.C. Board for Loudness/Speaker Mode P.C. Board Assembly
RESISTORS		
R651-R652	RT0510304	Carbon, 10K $\Omega$ , $\pm$ 5%, 1/4W

REF. DESIG.	MARANTZ PART NO.	DESCRIPTION
R653-R654	RT1010414	Carbon, 100K $\Omega$ , $\pm$ 10%, 1/4W
R655-R656	GS1010103	Wire Wound, 100 $\Omega$ , $\pm$ 10%, 3W
CAPACITORS		
C651-C652	DF1733301	Mylar, 0.033 $\mu$ F, $\pm$ 20%
C653-C654	DD1510101	Ceramic, 100pF, $\pm$ 5%
MISCELLANEOUS		
S651	SP0404003	Push Switch
J651-J655	YP1000094	Plug
P700	YD2818010 (ZZ2818010)	P.C. Board for Phono Amp. P.C. Board Assembly
RESISTORS		
R701-R702	RT0547314	Carbon, 47K $\Omega$ , $\pm$ 5%, 1/4W
R703-R704	RT1047114	Carbon, 470 $\Omega$ , $\pm$ 10%, 1/4W
R705	RN1033314	Carbon, 33K $\Omega$ , $\pm$ 10%, 1/4W
R706-R707	RN1010514	Carbon, 1M $\Omega$ , $\pm$ 10%, 1/4W
R708-R709	RA0104012	Trimmer, 100K $\Omega$ , (B)
R710-R711	RN1027314	Carbon, 27K $\Omega$ , $\pm$ 10%, 1/4W
R712-R713	GT0562112	Carbon, 620 $\Omega$ , $\pm$ 5%, 1/2W
R714-R715	RT0522514	Carbon, 2.2M $\Omega$ , $\pm$ 5%, 1/4W
R716-R717	RN1022514	Carbon, 2.2M $\Omega$ , $\pm$ 10%, 1/4W
R718-R719	RN1027414	Carbon, 270K $\Omega$ , $\pm$ 10%, 1/4W
R720-R721	GT0547312	Carbon, 47K $\Omega$ , $\pm$ 5%, 1/2W
R722-R723	GT0522212	Carbon, 2.2K $\Omega$ , $\pm$ 5%, 1/2W
R724-R725	GT0568412	Carbon, 680K $\Omega$ , $\pm$ 5%, 1/2W
R726-R727	RN1010414	Carbon, 100K $\Omega$ , $\pm$ 10%, 1/4W
R728-R729	RN1047314	Carbon, 47K $\Omega$ , $\pm$ 10%, 1/4W
R730-R731	RT1047014	Carbon, 47 $\Omega$ , $\pm$ 10%, 1/4W
R732-R733	RN1033214	Carbon, 3.3K $\Omega$ , $\pm$ 10%, 1/4W
R734	RT1010114	Carbon, 100 $\Omega$ , $\pm$ 10%, 1/4W
CAPACITORS		
C701-C702	DF1747401	Mylar, 0.47 $\mu$ F, 50V, $\pm$ 20%
C703-C704	EV2260061	Elect, 22 $\mu$ F, 6.3V, +40%, -20%
C705-C706	DD1540004	Ceramic, 40pF, 50V, $\pm$ 5%
C707-C708	DD1104001	Ceramic, 4pF, 50V, $\pm$ 0.5pF
C709-C710	DF6456201	Ceramic, 5600pF, 50V, $\pm$ 2%
C711-C712	DF6416201	Mylar, 1650pF, 50V, $\pm$ 2%
C713	EA1070509	Elect., 100 $\mu$ F, 50V, +100%, -0%
C714-C715	DF1747401	Mylar, 0.47 $\mu$ F, 50V, $\pm$ 20%
SEMICONDUCTORS		
H701-H704	HT310002A	Transistor, 2SC1000, Gr or B1
H705-H706	HT304580R	Transistor, 2SC458LG A (B)
H707-H708	HD2000206	Diode, 1S1212
H709	HV0000206	Varistor, VD1212
MISCELLANEOUS		
J701-J706	YP1000091	Plug



REF. DESIG.	MARANTZ PART NO.	DESCRIPTION
R750	YD2818013 (ZZ2818013)	P.C. Board for Power Amp. P.C. Board Assembly
RESISTORS		
R751	RT0547414	Carbon, 470K $\Omega$ , $\pm$ 5%, 1/4W x 2
R752	RT1010214	Carbon, 1K $\Omega$ , $\pm$ 10%, 1/4W x 2
R753	GT0510412	Carbon, 100K $\Omega$ , $\pm$ 5%, 1/2W x 2
R754	RT1015114	Carbon, 150 $\Omega$ , $\pm$ 10%, 1/4W x 2
R755	GT0522312	Carbon, 22K $\Omega$ , $\pm$ 5%, 1/2W x 2
R756	RT0575214	Carbon, 7.5K $\Omega$ , $\pm$ 5%, 1/4W x 2
R757	RT0543214	Carbon, 4.3K $\Omega$ , $\pm$ 5%, 1/4W x 2
R758	GT0522412	Carbon, 220K $\Omega$ , $\pm$ 5%, 1/2W x 2
R759	GT0510412	Carbon, 100K $\Omega$ , $\pm$ 5%, 1/2W x 2
R760-R761	GT0510312	Carbon, 10K $\Omega$ , $\pm$ 5%, 1/2W x 2
R762	RA0222004	Trimmer, 2.2K $\Omega$ , (B) 0.3W
R763	RA0102013	Trimmer, 1K $\Omega$ , (B) 0.3W x 2
R764	RT0551214	Carbon, 5.1K $\Omega$ , $\pm$ 5%, 1/4W x 2
R765	RT0556014	Carbon, 56 $\Omega$ , $\pm$ 5%, 1/4W x 2
R766	RT0527114	Carbon, 270 $\Omega$ , $\pm$ 5%, 1/4W x 2
R767-R768	GT0522201	Carbon, 2.2K $\Omega$ , $\pm$ 5%, 1W x 2
R769-R770	RT0568114	Carbon, 680 $\Omega$ , $\pm$ 5%, 1/4W x 2
R771-R772	RT0527314	Carbon, 27K $\Omega$ , $\pm$ 5%, 1/4W x 2
R773-R774	RT0556014	Carbon, 56 $\Omega$ , $\pm$ 5%, 1/4W x 2
R775	RT0547314	Carbon, 47K $\Omega$ , $\pm$ 5%, 1/4W x 2
R776-R777	GT0530312	Carbon, 30K $\Omega$ , $\pm$ 5%, 1/2W x 2
R778-R779	RT0556114	Carbon, 560 $\Omega$ , $\pm$ 5%, 1/4W x 2
R780-R781	RT0568214	Carbon, 6.8K $\Omega$ , $\pm$ 5%, 1/4W x 2
R782-R783	RT0515214	Carbon, 1.5K $\Omega$ , $\pm$ 5%, 1/4W x 2
R784-R785	RJ1003901	Carbon, 3.9 $\Omega$ , $\pm$ 10%, 1W x 2
R786-R787	RJ1010101	Carbon, 100 $\Omega$ , $\pm$ 10%, 1W x 2
R788-R789	GW1020205	Wire Wound, 0.2 $\Omega$ , $\pm$ 10%, 5W x 2
R790	GT0510002	Carbon, 10 $\Omega$ , $\pm$ 5%, 2W x 2
R791	RJ1002201	Carbon, 2.2 $\Omega$ , $\pm$ 10%, 1W x 2
R792-R793	RT0510314	Carbon, 10K $\Omega$ , $\pm$ 5%, 1/4W x 2
R794-R795	RA0502013	Trimmer, 4.7K $\Omega$ , (B) 0.15W x 2
R796	RA0104012	Trimmer, 100K $\Omega$ , (B) 0.15W x 2
R797-R798	RT0556314	Carbon, 56K $\Omega$ , $\pm$ 5%, 1/4W x 2
CAPACITORS		
C751	DF2710550	Mylar, 1 $\mu$ F, 100V, $\pm$ 20% x 2
C752	DD1510101	Ceramic, 100pF, 50V, $\pm$ 5%, x 2
C753	DK1610251	Ceramic, 1000pF, 500V, $\pm$ 10% x 2
C754	DK1650150	Ceramic, 500pF, 500V, $\pm$ 10% x 2
C755	DD1510050	Ceramic, 10pF, 500V, $\pm$ 5% x 2
C756	DD1515150	Ceramic, 150pF, 500V, $\pm$ 5% x 2
C757-C758	DF1710452	Mylar, 0.1 $\mu$ F, 200V, $\pm$ 20% x 2
C759-C760	EA1060169	Elect., 10 $\mu$ F, 16V, x 2
C761	EV2260061	Elect., 22 $\mu$ F, 6.3V, +40%, -20% x 2
C762	DF1710452	Mylar, 0.1 $\mu$ F, 200V, $\pm$ 20% x 2
C763	DF1722452	Mylar, 0.22 $\mu$ F, 100V, $\pm$ 20% x 2
SEMICONDUCTORS		
H751	HK064019A	Transistor, 2SA640 (M) or (L) x 2
H753	HT309451Q	Transistor, 2SC945 (Q) x 2

REF. DESIG.	MARANTZ PART NO.	DESCRIPTION
H754-H755	HT307351B	Transistor, 2SC735 (O) x 2
H756	HK048419A	Transistor, 2SA484, 2SC484 R or Y x 2
H758	HT306801B	Transistor, 2SC680 (B) x 2
H759	HT105661B	Transistor, 2SA566 (B) x 2
H760	HT309841B	Transistor, 2SC984 (B) x 2
H761	HD2000307	Diode, SM-150-01 x 2
H762-H763	HD3002009	Diode, BZ-150 x 2
H764-H765	HD3002309	Diode, WZ-071 x 2
H766-H767	HT105621C	Transistor, 2SA562 (Y) x 2
H768-H769	HH0000812	Thermistor, 21D28 150 $\Omega$ , $\pm$ 15% x 2
MISCELLANEOUS		
L751	LC2102001	Choke Coil, 2 $\mu$ H x 2
J751-J761	YP1000091	Plug x 2
P800	YD2818012 (ZZ2818012)	P.C. Board for Power Supply P.C. Board Assembly
RESISTORS		
R802	RC1033212	Solid, 3.3K $\Omega$ , $\pm$ 10%, 1/2W
R803-R804	RC1010012	Solid, 10 $\Omega$ , $\pm$ 10%, 1/2W
R805	RT1047214	Carbon, 4.7K $\Omega$ , $\pm$ 10%, 1/4W
R806	RT1015214	Carbon, 1.5K $\Omega$ , $\pm$ 10%, 1/4W
R807	RC1039212	Solid, 3.9K $\Omega$ , $\pm$ 10%, 1/2W
R808	RT1027314	Carbon, 27K $\Omega$ , $\pm$ 10%, 1/4W
R809	RA0502013	Trimmer, 4.7K $\Omega$ , (B)
R810	RT1056214	Carbon, 5.6K $\Omega$ , $\pm$ 10%, 1/4W
R811-R812	RC1056212	Solid, 5.6K $\Omega$ , $\pm$ 10%, 1/2W
R813	RT1022314	Carbon, 22K $\Omega$ , $\pm$ 10%, 1/4W
R814	RT1047214	Carbon, 4.7K $\Omega$ , $\pm$ 10%, 1/4W
R815	RT1039314	Carbon, 39K $\Omega$ , $\pm$ 10%, 1/4W
R816	RT1039414	Carbon, 390K $\Omega$ , $\pm$ 10%, 1/4W
R817	RT1039314	Carbon, 39K $\Omega$ , $\pm$ 10%, 1/4W
R818	RJ1047102	Carbon, 470 $\Omega$ , $\pm$ 10%, 2W
CAPACITORS		
C801	EB4770631	Elect., 470 $\mu$ F, 63V, +100%, -10%
C802	EA3370509	Elect., 330 $\mu$ F, 50V, +100%, -10%
C803	EA4770169	Elect., 470 $\mu$ F, 16V, +100%, -10%
C804	EA3370509	Elect., 330 $\mu$ F, 50V, +100%, -10%
C805	EA3350359	Elect., 3.3 $\mu$ F, 35V, +100%, -10%
C806	EA1060509	Elect., 10 $\mu$ F, 50V, +100%, -10%
C807	EA2270109	Elect., 220 $\mu$ F, 10V, +100%, -10%
C808-C809	DK1810351	Ceramic, 0.01 $\mu$ F, +100%, -10%
C810	EA4760169	Elect., 47 $\mu$ F, 16V, +100%, -10%
SEMICONDUCTORS		
H801-H802	HD2000413	Diode, SIB-01-02
H803	HT403154A	Transistor, 2SD315 (C, D, E, F)
H804	HD3002109	Diode, BZ-140 (14V 1W)
H805	HT306965A	Transistor, 2SC696
H806	HT307341C	Transistor, 2SC734 (Y)
H807	HD3002309	Diode, WZ-071 (0.5W 7.1V+0.4)
H808	HT309452A	Transistor, 2SC945 R or Q
H809-H810	HT312133A	Transistor, 2SC1213A (A, B or C)
H811-H813	HD2000413	Diode, SIB-01-02

REF. DESIG.	MARANTZ PART NO.	DESCRIPTION
J801-J805 J811-J812	YP1000091 YP1000091	Plug Plug
		SEMICONDUCTORS
H005	HD2001410	Diode, 6B20
		TRANSFORMERS
L001	LF1120023	AM Ant. Coil
L002	LB3007525	Balun Coil, FM 300Ω → 750Ω
L003	LC1302001	Choke Coil, 3μH
L004	TS6140101	Power Transf.
		MISCELLANEOUS
M001	IM1104201	AM/FM Signal Meter
M002	IM1104202	FM Tuning Meter
M003-M004	IN1006301	Stereo Lamp, 6.3V, 0.04A
M005-M010	IN1006301	Function Illumination Lamp, 6.3V, 0.04A
M011	IN1008018	Dial Pointer Illumination Lamp 8V, 0.006A
M012-M016	IN1008007	Dial Lamp, 8V, 0.2A
M017-M018	IN1008007	Metre Lamp, 8V, 0.2A
S001	SS0202017	FM Ant. Attenuator Switch
S002	SR1206002	Function Switch
S003	SP0201007	Power Supply Push Switch
S004	SP0404004	Multipath, Hi Blend, Tape1, 2, Tape Moni, Push Switch
J006-J007	YP1000097	Plug, Main-In Pre-Out
J008	YJ0100065	Dubbing Out Jack
J009	YJ0100055	Dubbing In Jack
J010	YJ0100055	Headphone Jack
J011	YJ0800012	Fuse Holder Socket
J014-J017	YJ0500013	Power Transistor Socket
J018	YL0106004	Terminal for AC Line Voltage Select
J019	YT0101003	Ground Terminal
J021-J028	YP1000094	Plug
J029-J033	YJ0800013	Dial Illumination Socket
J034-J035	YJ0800013	Meter Illumination Socket
J036-J037	YL0107001	7P Terminal
J038	YL0107005	7P Terminal
J039	YL1014001	4P Terminal
J040	YL0102003	2P Terminal
J041	YJ0500017	Transistor (T0-66) Socket
J042	YP1000094	Plug
J043	YL0102003	2P Terminal
J044-J047	YJ0800009	Socket
F001-F002	FS1040004	Fuse

REF. DESIG.	MARANTZ PART NO.	DESCRIPTION
W001	YC0240006	AC Cord
W002-W003	YB0007001	Connective Cord
W004	YB0027001	Connective Cord
W005	YW2818001	Wire Material
W006	YX2818001	Wire Material
		RESISTORS
R001	RC1008212	Solid, 8.2Ω, ±10%, 1/2W
R002-R003	RC1068012	Solid, 68Ω, ±10%, 1/2W
R004	RK0254002	Variable, 250KΩ, (B)
R005	RM0254020	Variable, 250KΩ, (MN)
R006	RM0254021	Variable, 250KΩ, (A)
R007-R008	RT1047214	Carbon, 4.7KΩ, ±10%, 1/4W
R009-R010	RJ1022202	Carbon, 2.2KΩ, ±10%, 2W
R011	RC1020012	Solid, 20Ω, ±10%, 1/2W
R012	RC1010212	Solid, 1KΩ, ±10%, 1/2W
R013	GS1015105	Wire Wound, 150Ω, ±10%, 5W
R014	GT0522501	Carbon, 2.2MΩ, ±10%, 1W
R015-R016	RJ1047002	Carbon, 47Ω, ±10%, 2W
R017	RC1018012	Solid, 18Ω, ±10%, 1/2W
R022	RA0103018	Trimmer, 10KΩ, B
R023	RT1082214	Carbon, 8.2KΩ, ±10%, 1/4W
R024	RT1012214	Carbon, 1.2KΩ, ±10%, 1/4W
		CAPACITORS
C001	DD1105001	Ceramic, 5pF, 50V, ±0.25pF
C002	DF1722301	Mylar, 0.022μF, 50V, ±20%
C003	DK1710301	Ceramic, 0.01μF, 50V, ±20%
C004	DO0756380	Oil Paper, 0.056μF, 800V, AC, ±20%
C005-C006	DO0720350	Oil Paper, 0.02μF, 600V DC, ±20%
C007-C008	EC9080551	Elect., 9000μF, 55V
C009	EA3360109	Elect., 33μF, 10V
C010	CA0330002	Variable, AM 3Gang
C011-C012	DK1710301	Ceramic, 0.01μF, 50V, ±20%
C013	EA4750359	Elect., 4.7μF, 35V
C014-C015	DK1710301	Ceramic, 0.01μF, 50V, ±20%

## SPECIFICATIONS

### AUDIO CIRCUITS:

Rated continuous (RMS) power output per channel, both channels operating simultaneously, 20Hz to 20,000Hz. ....	70 Watts at 4 and 8 ohms 40 Watts at 16 ohms
Comparable Total Music Power (IHF) .....	210 Watts at 8 ohms
High-level hum and noise (ref. 40W at 8 ohms) .....	-80 dB
Phono hum and noise .....	1.5 $\mu$ V equivalent input
Dynamic range (phono input to tape recording output) .....	96 dB
I. M. Distortion (SMPTE), at rated power .....	0.3%
Distortion decreases as output is lowered	
Total Harmonic Distortion, at rated Power .....	0.3% Maximum
Distortion decreases as output is lowered	
Power Bandwidth (IHF) for 0.3% THD .....	7Hz to 50,000Hz
Damping Factor (ref. 8 ohms) .....	Greater than 45
Frequency Response	
Through phono .....	$\pm 1$ dB
Input Sensitivity (for 40W at 8 ohms)	
High-level .....	180 mV
Phono (1,000 Hz) .....	1.8 mV
Input Impedance	
High-level .....	100,000 ohms
Phono .....	47,000 ohms
Channel Separation 20 Hz to 20,000 Hz .....	35 dB Minimum

### FM SECTIONS:

IHF Usable Sensitivity .....	2.3 $\mu$ V
Selectivity .....	80 dB
Noise Quieting .....	-55 dB at 5 $\mu$ V -60 dB at 10 $\mu$ V -65 dB at 50 $\mu$ V
Total Harmonic Distortion, 400 Hz, 100% Mod. ....	(Mono) 0.2% (Stereo) 0.4%
Frequency Response (ref. 75 $\mu$ sec. de-emphasis) .....	$\pm 1$ dB 50 Hz to 15 KHz
Stereo Separation .....	1,000 Hz 40 dB
Sub-Carrier (38 KHz) Suppression .....	60dB

### GENERAL:

Power Requirements .....	100/120/200/220/240V AC 50 to 60 Hz
At rated output, both channels operating .....	500 Watts
Idling Power (Volume Control at zero) .....	38 Watts
Dimensions	
Panel Width .....	17 <sup>21</sup> / <sub>64</sub> Inches
Panel Height .....	5 <sup>25</sup> / <sub>64</sub> Inches
Depth .....	14 Inches
Weight	
Unit alone .....	38.5lbs
Packed for shipment .....	49.5lbs

\* These specifications and exterior designs may be changed for improvement without advance notice.



**marantz**

**MARANTZ CO., INC. • P.O. BOX 99 • SUN VALLEY, CALIFORNIA • 91352**

**A WHOLLY-OWNED SUBSIDIARY OF SUPERSCOPE INC., SUN VALLEY, CALIFORNIA 91352**

*the crowning touch of perfection*



**marantz**

## MODEL 2270 SERVICE MANUAL

This Service Manual is the first revised edition for model 2270 (Applied to production serial No. from 1001 to 4900).

Included in this service manual are schematic diagram, individual parts list and P.C. Board-Component Assembly Diagram.

On the circuit description alignment method and repairing hints, refer to the original service manual.

### TABLE OF CONTENTS

Parts List .....	1
Schematic Diagram .....	3
P.C. Board-Component Assembly Diagram .....	5

**marantz**

REF. DESIG.	MARANTZ PART NO.	DESCRIPTION		
P200	YD2818003 (ZZ2818003)	P.C. Board P.C. Board Assembly		
		RESISTORS		
R201	RT1015114	Carbon, 150 $\Omega$ ,	$\pm 10\%$ ,	1/4W
R202	RT1082114	Carbon, 820 $\Omega$ ,	$\pm 10\%$ ,	1/4W
R203	RT1015114	Carbon, 150 $\Omega$ ,	$\pm 10\%$ ,	1/4W
R204	RT1015214	Carbon, 1.5K $\Omega$ ,	$\pm 10\%$ ,	1/4W
R205	RT1033214	Carbon, 3.3K $\Omega$ ,	$\pm 10\%$ ,	1/4W
R206	RT1010214	Carbon, 1K $\Omega$ ,	$\pm 10\%$ ,	1/4W
R207	RT1033114	Carbon, 330 $\Omega$ ,	$\pm 10\%$ ,	1/4W
R211	RT1082114	Carbon, 820 $\Omega$ ,	$\pm 10\%$ ,	1/4W
R212	RT1015114	Carbon, 150 $\Omega$ ,	$\pm 10\%$ ,	1/4W
R213	RT1015214	Carbon, 1.5K $\Omega$ ,	$\pm 10\%$ ,	1/4W
R214	RT1033214	Carbon, 3.3K $\Omega$ ,	$\pm 10\%$ ,	1/4W
R215	RT1010214	Carbon, 1K $\Omega$ ,	$\pm 10\%$ ,	1/4W
R216	RT1033114	Carbon, 330 $\Omega$ ,	$\pm 10\%$ ,	1/4W
R218-R219	RT1015114	Carbon, 150 $\Omega$ ,	$\pm 10\%$ ,	1/4W
R220	RT1082114	Carbon, 820 $\Omega$ ,	$\pm 10\%$ ,	1/4W
R221	RT1015114	Carbon, 150 $\Omega$ ,	$\pm 10\%$ ,	1/4W
R222	RT1015214	Carbon, 1.5K $\Omega$ ,	$\pm 10\%$ ,	1/4W
R223	RT1033214	Carbon, 3.3K $\Omega$ ,	$\pm 10\%$ ,	1/4W
R224	RT1010214	Carbon, 1K $\Omega$ ,	$\pm 10\%$ ,	1/4W
R225	RT1033114	Carbon, 330 $\Omega$ ,	$\pm 10\%$ ,	1/4W
R229	RT1082114	Carbon, 820 $\Omega$ ,	$\pm 10\%$ ,	1/4W
R230	RT1015114	Carbon, 150 $\Omega$ ,	$\pm 10\%$ ,	1/4W
R232	RT1033214	Carbon, 3.3K $\Omega$ ,	$\pm 10\%$ ,	1/4W
R233	RT1010214	Carbon, 1K $\Omega$ ,	$\pm 10\%$ ,	1/4W
R234	RT1033114	Carbon, 330 $\Omega$ ,	$\pm 10\%$ ,	1/4W
R235	RT1015114	Carbon, 150 $\Omega$ ,	$\pm 10\%$ ,	1/4W
R236	RT1010414	Carbon, 100K $\Omega$ ,	$\pm 10\%$ ,	1/4W
R237	RT1015114	Carbon, 150 $\Omega$ ,	$\pm 10\%$ ,	1/4W
R238	RT1015214	Carbon, 1.5K $\Omega$ ,	$\pm 10\%$ ,	1/4W
R239	RT1033214	Carbon, 3.3K $\Omega$ ,	$\pm 10\%$ ,	1/4W
R240-R241	RT1010214	Carbon, 1K $\Omega$ ,	$\pm 10\%$ ,	1/4W
R242	RT1015114	Carbon, 150 $\Omega$ ,	$\pm 10\%$ ,	1/4W
R243	RT1010414	Carbon, 100K $\Omega$ ,	$\pm 10\%$ ,	1/4W
R244	RT1039114	Carbon, 390 $\Omega$ ,	$\pm 10\%$ ,	1/4W
R245	RT1082214	Carbon, 8.2K $\Omega$ ,	$\pm 10\%$ ,	1/4W
R231	RT1015214	Carbon, 1.5K $\Omega$ ,	$\pm 10\%$ ,	1/4W
R246	RT1015314	Carbon, 15K $\Omega$ ,	$\pm 10\%$ ,	1/4W
R247-R248	RT1010214	Carbon, 1K $\Omega$ ,	$\pm 10\%$ ,	1/4W
R249	RT1033114	Carbon, 330 $\Omega$ ,	$\pm 10\%$ ,	1/4W
R250	RT1015114	Carbon, 150 $\Omega$ ,	$\pm 10\%$ ,	1/4W
R251	RT1010414	Carbon, 100K $\Omega$ ,	$\pm 10\%$ ,	1/4W
R252	RT1047014	Carbon, 47 $\Omega$ ,	$\pm 10\%$ ,	1/4W
R253-R257	RT1010114	Carbon, 100 $\Omega$ ,	$\pm 10\%$ ,	1/4W
R258	RT1012114	Carbon, 120 $\Omega$ ,	$\pm 10\%$ ,	1/4W
R259	RT1010114	Carbon, 100 $\Omega$ ,	$\pm 10\%$ ,	1/4W
R260	RT1047214	Carbon, 4.7K $\Omega$ ,	$\pm 10\%$ ,	1/4W
R261	RT1012314	Carbon, 12K $\Omega$ ,	$\pm 10\%$ ,	1/4W
R262	RT1010214	Carbon, 1K $\Omega$ ,	$\pm 10\%$ ,	1/4W
R263	RT1022214	Carbon, 2.2K $\Omega$ ,	$\pm 10\%$ ,	1/4W

REF. DESIG.	MARANTZ PART NO.	DESCRIPTION		
R264	RT1033314	Carbon, 33K $\Omega$ ,	$\pm 10\%$ ,	1/4W
R265	RT1027314	Carbon, 27K $\Omega$ ,	$\pm 10\%$ ,	1/4W
R266	RT1047314	Carbon, 47K $\Omega$ ,	$\pm 10\%$ ,	1/4W
R267	RT1022214	Carbon, 2.2K $\Omega$ ,	$\pm 10\%$ ,	1/4W
R268	RT1027314	Carbon, 27K $\Omega$ ,	$\pm 10\%$ ,	1/4W
R269	RT1047314	Carbon, 47K $\Omega$ ,	$\pm 10\%$ ,	1/4W
R270	RT1027314	Carbon, 27K $\Omega$ ,	$\pm 10\%$ ,	1/4W
R271	RT1047314	Carbon, 47K $\Omega$ ,	$\pm 10\%$ ,	1/4W
R272	RT1056214	Carbon, 5.6K $\Omega$ ,	$\pm 10\%$ ,	1/4W
R273	RT1010314	Carbon, 10K $\Omega$ ,	$\pm 10\%$ ,	1/4W
R274	RT1010114	Carbon, 100 $\Omega$ ,	$\pm 10\%$ ,	1/4W
R275	RT1056214	Carbon, 5.6K $\Omega$ ,	$\pm 10\%$ ,	1/4W
R276	RT1022314	Carbon, 22K $\Omega$ ,	$\pm 10\%$ ,	1/4W
R277	RT1056314	Carbon, 56K $\Omega$ ,	$\pm 10\%$ ,	1/4W
R278	RT1022214	Carbon, 2.2K $\Omega$ ,	$\pm 10\%$ ,	1/4W
		CAPACITORS		
C201-C203	DK1710301	Ceramic, 0.01 $\mu$ F,	$\pm 20\%$ ,	
C205	DK1710301	Ceramic, 0.01 $\mu$ F,	$\pm 20\%$	
C207-C213	DK1710301	Ceramic, 0.01 $\mu$ F,	$\pm 20\%$	
C215	DK1840302	Ceramic, 0.04 $\mu$ F,	+100%, -0%	
C216	EA1060162	Elect., 10 $\mu$ F,	16V	
C217	DK1840302	Ceramic, 0.04 $\mu$ F,	+100%, -0%	
C218	EA1060162	Elect., 10 $\mu$ F,	16V	
C219	DK1840302	Ceramic, 0.04 $\mu$ F,	+100%, -0%	
C220	EA1060162	Elect., 10 $\mu$ F,	16V	
C221	DK1840302	Ceramic, 0.04 $\mu$ F,	+100%, -0%	
C222	EA1060162	Elect., 10 $\mu$ F,	16V	
C223	DK1840302	Ceramic, 0.04 $\mu$ F,	+100%, -0%	
C224	EA1060162	Elect., 10 $\mu$ F,	16V	
C225	DK1840302	Ceramic, 0.04 $\mu$ F,	+100%, -0%	
C226	EA1060162	Elect., 10 $\mu$ F,	16V	
C227	DK1840302	Ceramic, 0.04 $\mu$ F,	+100%, -0%	
C228-C229	DK1710301	Ceramic, 0.01 $\mu$ F,	$\pm 20\%$	
C230	DK1840302	Ceramic, 0.04 $\mu$ F,	+100%, -0%	
C231-C233	DK1710301	Ceramic, 0.01 $\mu$ F,	$\pm 20\%$	
C234	DK1710201	Ceramic, 0.001 $\mu$ F,	$\pm 20\%$	
C235	DK1710301	Ceramic, 0.01 $\mu$ F,	$\pm 20\%$	
C236	DK1710201	Ceramic, 0.001 $\mu$ F,	$\pm 20\%$	
C237	DK1710301	Ceramic, 0.01 $\mu$ F,	$\pm 20\%$	
C238	DK1710201	Ceramic, 0.001 $\mu$ F,	$\pm 20\%$	
C239-C240	DK1710301	Ceramic, 0.01 $\mu$ F,	$\pm 20\%$	
C241	DK1710201	Ceramic, 0.001 $\mu$ F,	$\pm 20\%$	
C242-C245	DK1810402	Ceramic, 0.1 $\mu$ F,	+100%, -0%	
C243	EA4750162	Elect., 4.7 $\mu$ F,	16V	
C246	EA1060162	Elect., 10 $\mu$ F,	16V	
C247	DD1540001	Ceramic, 40pF,	$\pm 5\%$	
		SEMICONDUCTORS		
H201-H207	HT308291C	Transistor, 2SC829C		
H208-H209	HT303721C	Transistor, 2SC372		
H215-H216	HD2001105	Diode, 1S1555		
H217-H220	HD1000109	Diode, 1S1008		

REF. DESIG.	MARANTZ PART NO.	DESCRIPTION
<b>SEMICONDUCTORS</b>		
H201-H207	HT308291C	Transistor, 2SC829C
H208-H209	HT303721C	Transistor, 2SC372
H215-H216	HD2001105	Diode, 1S1555
H217-H220	HD1000109	Diode, 1S1008
H221-H232	HD1000105	Diode, 1N60
<b>MISCELLANEOUS</b>		
F201-F208	FF1107003	Ceramic Filter SFA 1Q.7MC
J201-J209	YP1000094	Plug
P750	YD2818007 (ZZ2818007)	P.C. Board for Power Amp. P.C. Board Assembly
<b>RESISTORS</b>		
R751	RN1047414	Carbon, 470K $\Omega$ , $\pm 10\%$ , 1/4W x 2
R752	RT1010214	Carbon, 1K $\Omega$ , $\pm 10\%$ , 1/4W x 2
R753	GT0510412	Carbon, 100K $\Omega$ , $\pm 5\%$ , 1/4W x 2
R754	RT1015114	Carbon, 150 $\Omega$ , $\pm 10\%$ , 1/4W x 2
R755	GT0522312	Carbon, 22K $\Omega$ , $\pm 5\%$ , 1/2W x 2
R756	GT0575212	Carbon, 7.5K $\Omega$ , $\pm 5\%$ , 1/2W x 2
R757	GT0543212	Carbon, 4.3K $\Omega$ , $\pm 5\%$ , 1/2W x 2
R758	GT0527412	Carbon, 270K $\Omega$ , $\pm 5\%$ , 1/2W x 2
R759	GT0510412	Carbon, 100K $\Omega$ , $\pm 5\%$ , 1/2W x 2
R760-R761	GT0510312	Carbon, 10K $\Omega$ , $\pm 5\%$ , 1/2W x 2
R762	RA0222004	Trimmer, 2.2K $\Omega$ , (B), 0.3W x 2
R763	RA0102013	Trimmer, 1K $\Omega$ , (B), 0.3W x 2
R764	GT0551212	Carbon, 5.1K $\Omega$ , $\pm 5\%$ , 1/2W x 2
R765	GT0556012	Carbon, 56 $\Omega$ , $\pm 5\%$ , 1/2W x 2
R766	GT0527112	Carbon, 270 $\Omega$ , $\pm 5\%$ , 1/2W x 2
R767-R768	GT0522201	Carbon, 2.2K $\Omega$ , $\pm 5\%$ , 1W x 2
R769-R770	GT0568112	Carbon, 680 $\Omega$ , $\pm 5\%$ , 1/2W x 2
R771-R772	GT0520312	Carbon, 20K $\Omega$ , $\pm 5\%$ , 1/2W x 2
R773-R774	GT0556012	Carbon, 56 $\Omega$ , $\pm 5\%$ , 1/2W x 2
R775	GT0547312	Carbon, 47K $\Omega$ , $\pm 5\%$ , 1/2W x 2
R776	GT0527312	Carbon, 27K $\Omega$ , $\pm 5\%$ , 1/2W x 2
R778-R779	GT0547112	Carbon, 470 $\Omega$ , $\pm 5\%$ , 1/2W x 2
R780-R781	GT0539212	Carbon, 3.9K $\Omega$ , $\pm 5\%$ , 1/2W x 2
R782-R783	RA0102001	Trimmer, 1K $\Omega$ , (B)
R784-R785	RJ1010001	Carbon, 10 $\Omega$ , $\pm 10\%$ , 1W x 2
R786-R787	RJ1012101	Carbon, 120 $\Omega$ , $\pm 10\%$ , 1W x 2
R788-R789	GW1020205	Wire Wound, 0.2 $\Omega$ , $\pm 10\%$ , 5W x 2
R790	GT0510002	Carbon, 10 $\Omega$ , $\pm 5\%$ , 2W x 2
R791	RJ1002201	Carbon, 2.2 $\Omega$ , $\pm 10\%$ , 1W x 2
R792	GT0556212	Carbon, 5.6K $\Omega$ , $\pm 5\%$ , 1/2W x 2
R793	GT0533212	Carbon, 3.3K $\Omega$ , $\pm 5\%$ , 1/2W
R777	GT0533312	Carbon, 33K $\Omega$ , $\pm 5\%$ , 1/2W
<b>CAPACITORS</b>		
C751	DF2710550	Mylar, 1 $\mu$ F, 100V, $\pm 20\%$ x2
C752	DD1510101	Ceramic, 100pF, 50V, $\pm 5\%$ , x2
C573	DK1610251	Ceramic, 1000pF, 500V, $\pm 10\%$ , x2
C754	DK1650150	Ceramic, 500pF, 500V, $\pm 10\%$ , x2

REF. DESIG.	MARANTZ PART NO.	DESCRIPTION
C755	DD1105050	Ceramic, 5pF, 500V, $\pm 0.25$ pF x2
C756	DD1515150	Ceramic, 150pF, 500V, $\pm 5\%$ , x2
C757-C758	DK1615201	Ceramic, 1500pF, 50V, $\pm 10\%$ , x2
C759-C760	EA1060061	Elect., 10 $\mu$ F, 16V, +100%, -0% x2
C761	EV2260161	Elect., 22 $\mu$ F, 6.3V, +40%, -20% x2
C762-C764	DF1710452	Mylar, 0.1 $\mu$ F, 200V, $\pm 20\%$ , x2
C765	DF1722452	Mylar, 0.22 $\mu$ F, 100V, $\pm 20\%$ , x2
<b>SEMICONDUCTORS</b>		
H751-H752	HK064019A	Transistor, 2SA640, (M) or (L) x2
H753	HT309451R	Transistor, 2SC945, (K) x2
H754	HT105392A	Transistor, 2SA539, (L) or (K) x2
H755	HT309451Q	Transistor, 2SC945 (Q) x 2
H756-H757	HK048419A	Transistor, 2SA484, 2SC484RorYx2
H758	HT306801B	Transistor, 2SC680 (B) x 2
H759	HT105661B	Transistor, 2SA566 (B) x 2
H760	HT309841B	Transistor, 2SC984 (B) x 2
H761	HD2000307	Diode, SM-150-01 x 2
H762-H763	HD3002009	Diode, BZ-150 x 2
H764-H765	HD3002309	Diode, WZ-071x 2
<b>MISCELLANEOUS</b>		
L751	LC2102001	Choke Coil, 2 $\mu$ H x 2
J751-J761	YP1000091	Plug x 2



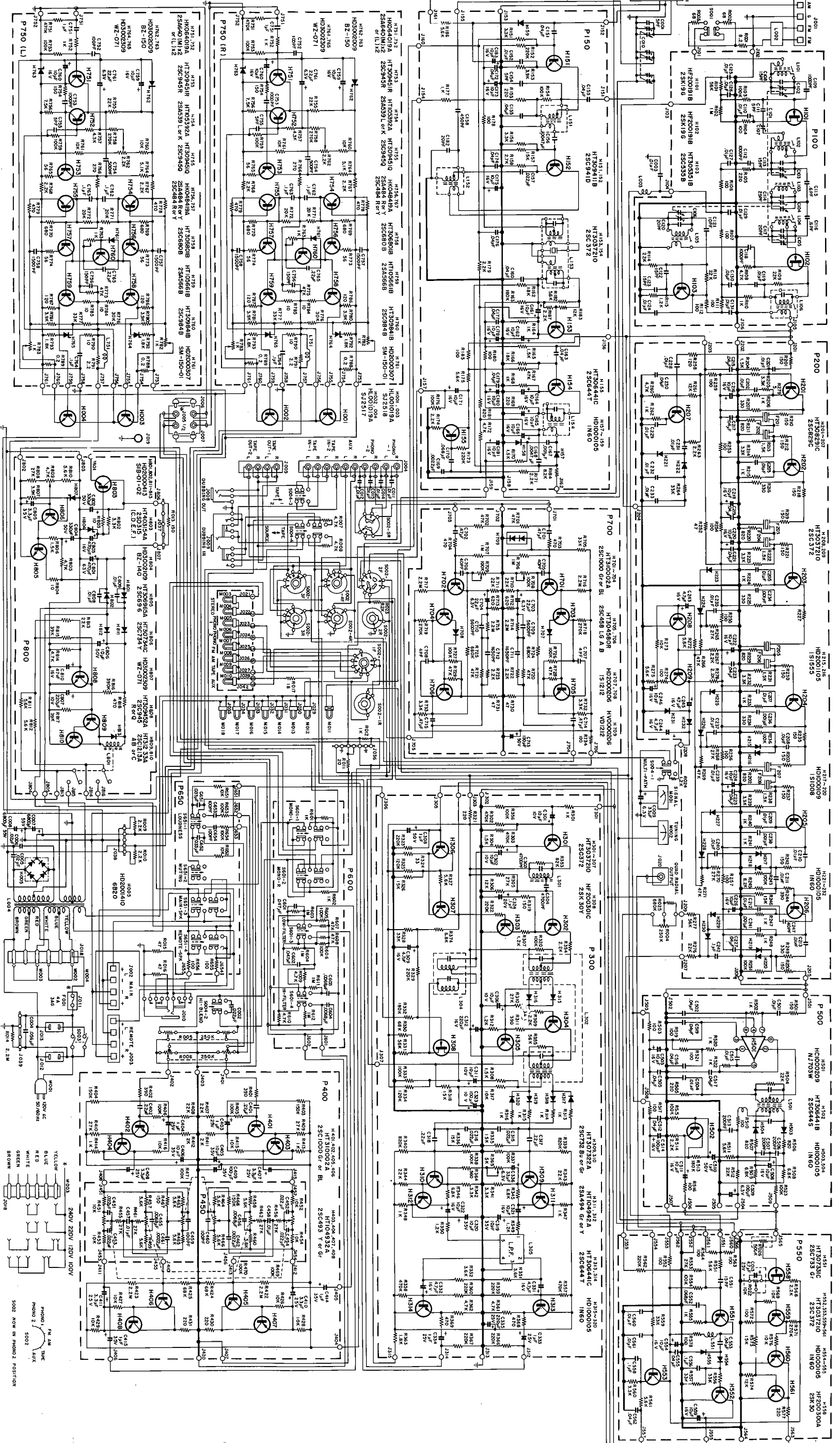

Applied to production Serial No. from 1001 to 3900.

Figure 1 Schematic Diagram

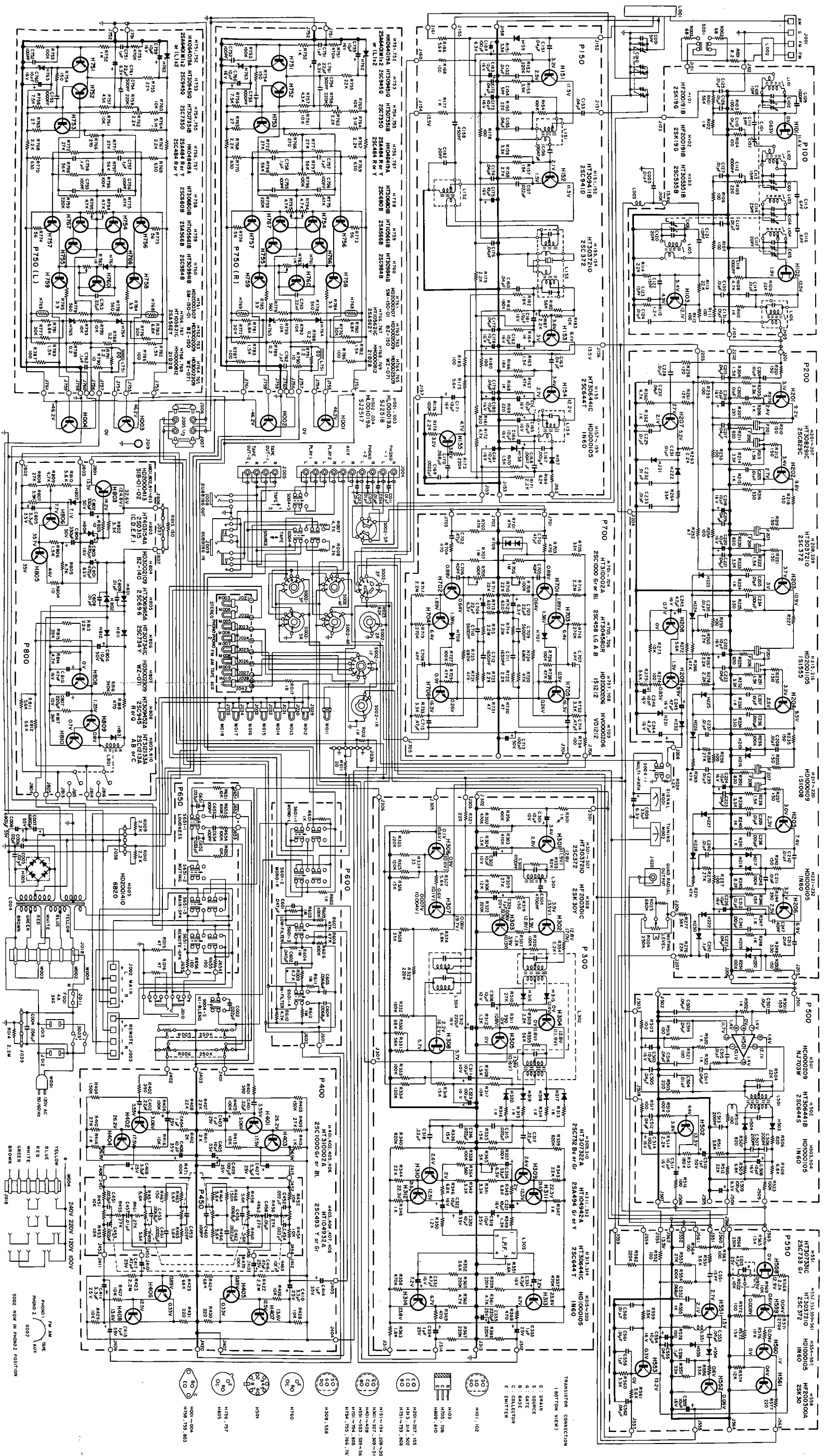

TRANSISTOR CONNECTION (BOTTOM VIEW)

- D: DRAIN
- S: SOURCE
- G: GATE
- B: BASE
- E: EMITTER
- F: SWITCH

502: NOW IN PHONO2 POSITION

PHONO 1  
PHONO 2  
AUX

YELLOW  
BLUE  
RED  
GREEN  
WHITE  
BROWN

500V AC  
240V 220V 120V 100V

5002

5001

5000

5003

5004

5005

5006

5007

5008

5009

5010

5011

5012

5013

5014

5015

5016

5017

5018

5019

5020

5021

5022

5023

5024

5025

5026

5027

5028

5029

5030

5031

5032

5033

5034

5035

5036

5037

5038

5039

5040

5041

5042

5043

5044

5045

5046

5047

5048

5049

5050

5051

5052

5053

5054

5055

5056

5057

5058

5059

5060

5061

5062

5063

5064

5065

5066

5067

5068

5069

5070

5071

5072

5073

5074

5075

5076

5077

5078

5079

5080

5081

5082

5083

5084

5085

5086

5087

5088

5089

5090

5091

5092

5093

5094

5095

5096

5097

5098

5099

5100

Applied to production Serial No. from 3901 to 4900.

Figure 2 Schematic Diagram

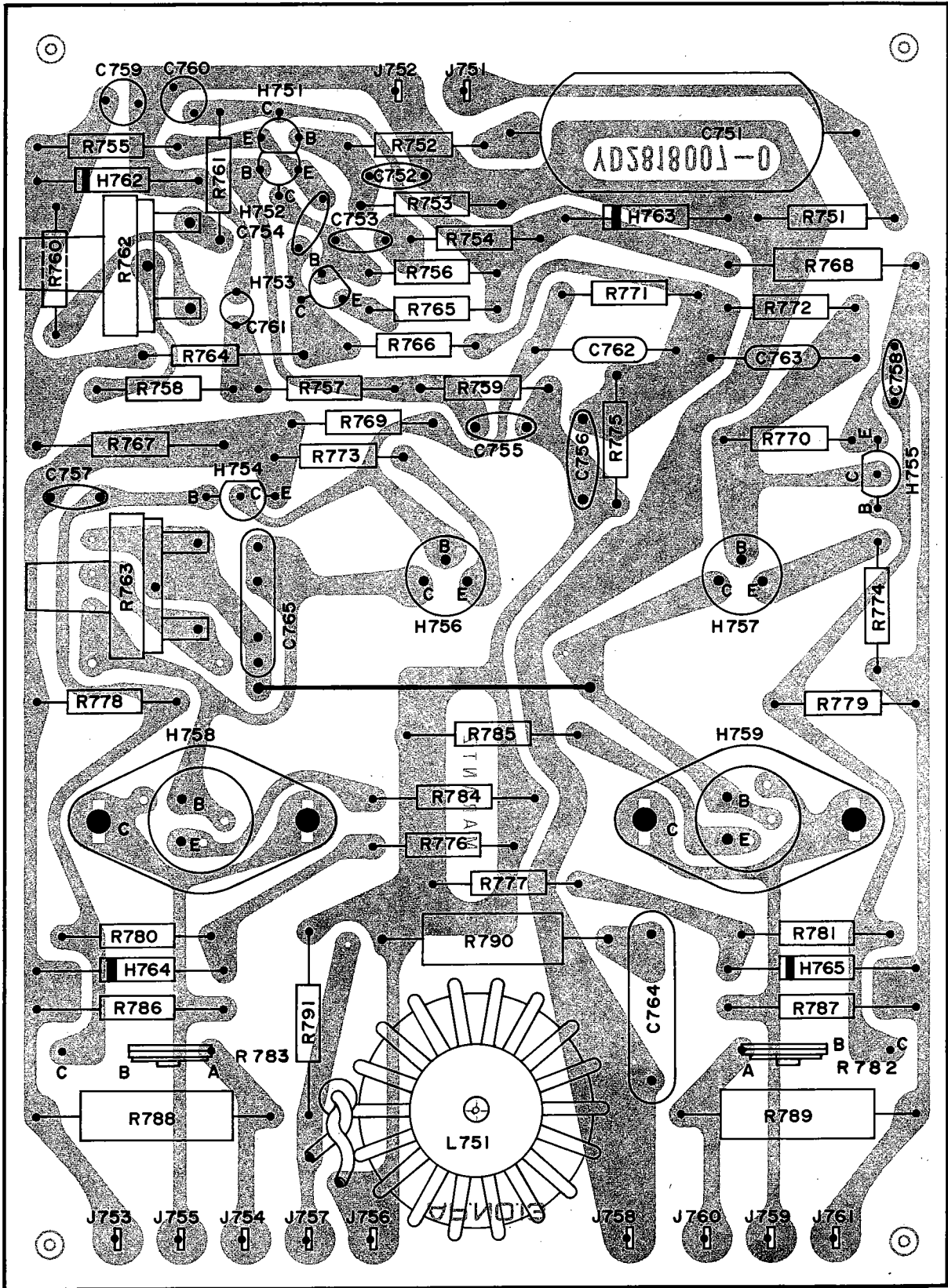

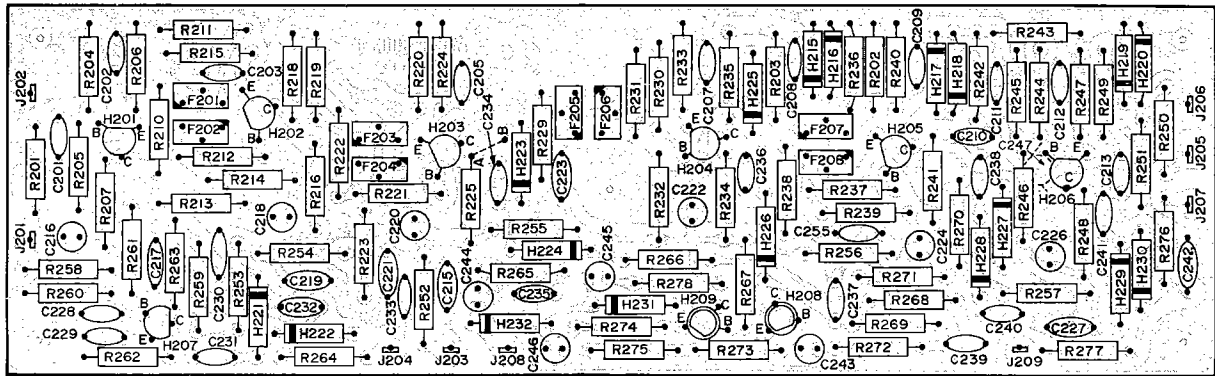

Figure 4 FM IF Amplifier Assembly P200 Component Locations